

# BETA

## Low-Voltage Circuit Protection



### 19/2 Introduction

#### Miniature Circuit Breakers

- 19/4 Miniature circuit breakers, 5SP and 5SY
- 19/21 Miniature circuit breakers with plug-in terminals, 5SJ6 ...-KS
- 19/23 Miniature circuit breakers 1 + N in 1 MW, 5SY6 0
- 19/25 Additional components
- 19/31 Busbars
- 19/39 Miniature circuit breakers according to UL 489 and IEC, 5SJ4 ...-HG
- 19/45 Circuit breaker terminals, 5SK9

#### Residual Current Protective Devices

- 19/47 RCCBs, type A, 5SM3
- 19/51 SIQUENCE, universal current-sensitive RCCBs type B and type B+, 5SM3 and 5SU1
- 19/54 Additional components
- 19/55 RC units, type A, 5SM2
- 19/58 RCBOs, type A, 5SU1
- 19/61 Busbars
- 19/63 Accessories

#### Low-Voltage Fuse Systems

- 19/64 NEOZED fuse systems
- 19/70 DIAZED fuse systems
- 19/76 3NW cylindrical fuse systems
- 19/79 3NW. ...-0HG Class CC fuse systems
- 19/81 5ST2, 5ST3 busbars for fuse systems
- 19/86 3NA, 3ND LV HRC fuse links
- 19/94 3NX1 LV HRC signal detectors
- 19/95 3NH LV HRC fuse bases
- Ch. 17 3NP1 LV HRC fuse switch disconnectors
- Ch. 17 3NP5 LV HRC fuse switch disconnectors for extended technical requirements

#### SITOR Semiconductor Fuses

- 19/101 SITOR, LV HRC design
- 19/109 SITOR, cylindrical fuse design
- 19/111 SILIZED, NEOZED and DIAZED design

#### SR60 Busbar Systems

- 19/112 Distribution board components
- 19/116 Built-in components
- 19/120 Mounting components

#### Overvoltage Protection Devices

- 19/122 Lightning arresters, type 1
- 19/123 Combination surge arresters, type 1 and type 2
- 19/124 Surge arresters, type 2
- 19/127 Surge arresters, type 3
- 19/128 Accessories for surge arresters
- 19/129 Surge arresters for measuring and control technology

#### Socket Outlets

- 19/131 5TE6 8 socket outlets

#### Three-Phase Measuring Devices

- 19/133 7KT1 30 multimeters
- 19/135 7KT1 31, 7KT1 34, 7KT1 35 multi-counters
- 19/137 7KT1 39 LAN couplers
- 19/139 7KT1 5 E-counters
- 19/140 7KT1 2 current transformers
- 19/140 7KT9 0 measuring selector switches

#### Single-Phase Measuring Devices

- 19/141 7KT1 53, 7KT1 14 E-counters
- 19/142 7KT1 11, 7KT1 12 digital measuring devices
- 19/142 7KT1 0 analog measuring devices
- 19/143 7KT5 8 time and pulse counters
- 19/144 7KT5 5, 7KT5 6 time counters for front mounting

For Austria there is a separate catalog "BETA Low-Voltage Circuit Protection", with special products according to Austrian regulations.

*Note:*

*More devices from the BETA low-voltage circuit protection range can be found in the Catalog ET B1 · 2010. You can download the up-to-date catalog from [www.siemens.com/e-installation-catalogs](http://www.siemens.com/e-installation-catalogs).*

# BETA Low-Voltage Circuit Protection

## Introduction

### Overview



Miniature circuit breakers 5SP4, 5SP5, 5SY4, 5SY5, 5SY6, 5SY7, 5SY8	Miniature circuit breakers with plug-in terminal 5SJ6 ...-KS	Miniature circuit breakers 1 + N in 1 MW 5SY6 0	Miniature circuit breakers according to UL 489 and IEC 5SJ4 ...-HG	Circuit breaker terminals 5SK9
--	---	--	---	-----------------------------------

#### Miniature circuit breakers

Tripping characteristic	A, B, C, D	B, C	B, C	B, C, D	--
Rated current	A 0.3 ... 125	10 ... 20	2 ... 40	0.3 ... 63	0.5 ... 10
Rated switching capacity	kA 6, 10, 15, 25	6	6	14/10	--



NEOZED fuse systems 5SE2, 5SG	DIAZED fuse systems 5SA ... 5SD, 5SF, 5SH	Cylindrical fuse systems 3NW6, 3NW7, 3NW8	Class CC fuse system 3NW1, 3NW2, 3NW3, 3NW7	LV HRC fuse links 3NA, 3ND	LV HRC signal detectors 3NX	LV HRC fuse bases 3NH
----------------------------------	--	--	--	-------------------------------	--------------------------------	--------------------------

#### Low-Voltage Fuse Systems

Operational classes	gG	gG	gG, aM	Slow/quick/slow, current limiting	gG, aM	--	--
Rated voltage	V AC V DC 400 250	500/690/750 500/600/750	400/500	600 150/300	400/500/690 250/440	690 600	690 250/440
Rated current range	A 2 ... 100	2 ... 100	0.5 ... 100	0.6 ... 30	2 ... 1250	--	160 ... 1250



Lightning arresters, type 1 5SD7	Combination surge arresters, type 1 and type 2 5SD7	Surge arresters, type 2 5SD7	Surge arresters, type 3 5SD7
-------------------------------------	--	---------------------------------	---------------------------------

#### Overvoltage protection devices

Rated voltage	V AC 230/400	230/400	230 ... 415	24 ... 400
Rated arrester voltage	V AC 350	350	260 ... 350	24 ... 230
Discharge capacity	kA 25/100	25/100	15/30; 20/40	1 ... 3



Multimeters 7KT1 30	Multicounters 7KT1 31, 7KT1 34, 7KT1 35	LAN couplers 7KT1 39	E-counters 7KT1 5	E-counters <i>instabus</i> KNX 7KT1 1	Current transformers 7KT1 2	Measuring selector switches 7KT9 0
------------------------	--	-------------------------	----------------------	--	--------------------------------	---------------------------------------

#### Three-phase measuring devices

Application	Display of 23 electrical measured values for switchgear assemblies, infeed or outgoing feeders.	Display of 35 electrical measured values and consumption values in switchgear assemblies, infeed or outgoing feeders.	Up-to-date consumption data of the multimeter available worldwide over LAN data communication.	Measurement of consumption data and plant capacity utilization in three-phase systems of system components, offices or holiday apartments.	Straight-through transformers for installation in distribution boards and non-contact measuring of primary currents.	For switching over the phases for voltmeters and ammeters
-------------	---	---	--	--	--	---



RCCBs,  
type A

5SM3



SIQUENCE, universal  
current-sensitive RCCBs,  
type B and type B+

5SM3, 5SU1



RC units,  
type A

5SM2



RCBOs,  
type A

5SU1

### Residual current protective devices

Types of current	Type A	Type B	Type A	Type A
Rated current A	16 ... 125	16 ... 125	0.3 ... 100	6 ... 125
Rated residual current mA	10 ... 1000	30 ... 500	10 ... 1000	10 ... 300



SITOR,  
LV HRC design

3NC, 3NE



SITOR,  
cylindrical fuse design

3NC



SILIZED,  
NEOZED and DIAZED design

5SE1, 5SD

### SITOR Semiconductor Fuses

Operational classes	aR, gR, gS	aR	gR
Rated voltage V AC	500 ... 2500	600/660/690	400/500
V DC	700	400/700	250/500
Rated current range A	16 ... 1600	1 ... 100	10 ... 100



Distribution board  
components

8GK, 8JH, 8JK, 8US



Built-in components

5SF, 5SG, 5SH



Mounting components

5SH, 8US



Socket outlets

5TE6 8

### SR60 busbar systems

Application	Busbars, busbar supports and covers	NEOZED/DIAZED bus-mounting bases, NEOZED bus-mounting switch disconnectors	Bases, blanking covers, edges
-------------	-------------------------------------	--	-------------------------------

### Socket outlets

Application	Power supply for maintenance of distribution boards
-------------	---



E-counters

7KT1 53  
7KT1 14



Digital measuring  
devices

7KT1 11, 7KT1 12



Analog measuring devices

7KT1 0



Time and  
pulse counters

7KT5 8



Time counters for front  
mounting

7KT5 5, 7KT5 6

### Single-phase measuring devices

Application	Measuring of kWh in single-phase networks	Measuring of voltages and currents with large three-digit LED displays	Measuring of voltages and currents for monitoring input and output currents	For monitoring operating hours and starting operations for planning preventative maintenance tasks and preventing sudden shutdowns	For monitoring operating hours and starting operations for planning preventative maintenance tasks and preventing sudden shutdowns
-------------	---	--	---	--	--

# BETA Protecting Miniature Circuit Breakers (MCBs)

Miniature circuit breakers,  
5SP and 5SY

## Overview

MCBs are used to protect plants in buildings and for industrial applications. The devices can be used as main control switches for the disconnection or isolation of plants.

For industrial applications and in plant engineering, miniature circuit breakers can be supplemented with additional components, such as auxiliary switches, fault signal contacts, shunt releases, undervoltage releases, remote-controlled mechanisms and RC units.

The devices are approved for worldwide use according to IEC standards for systems up to 250/440 V AC. 60 V DC per pole is permitted in DC systems.

For North America, we also have additional certification according to UL 1077 for use as "supplementary protectors" in systems up to AC 480Y/277 V. For use in ship building, the devices also have numerous certifications according to shipping classifications; BV, DNV, GL and LRS. For further information, please refer to the section "Configuration".

## Benefits

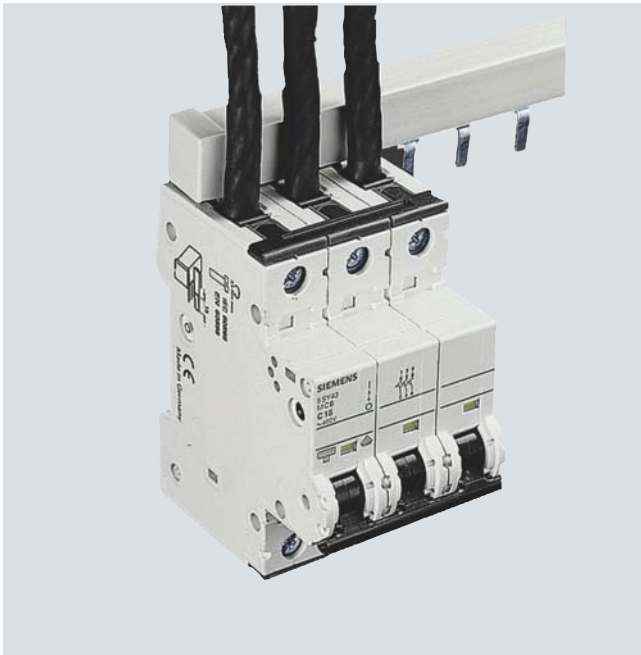

- The infeed can be either from the top or the bottom as the terminals are identical.
- Clear and visible conductor connection that can be easily checked in front of the busbar.
- Large and easily accessible wiring space enables easy insertion of conductor in the terminal.



- Integrated movable terminal covers located at the cable entries ensure the terminals are fully insulated when the screws are tightened.
- The effective touch protection when grasping the device considerably exceeds the requirements of BGV A3 (labor safety specification).

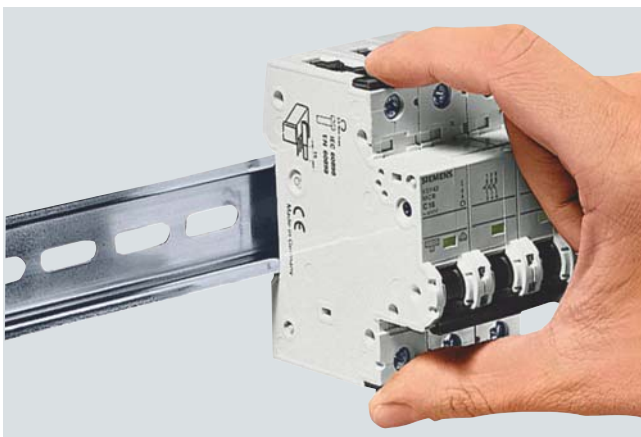

- Manual snap-on fixing and release systems that require no tools enable fast assembly and disassembly of MCBs.
- Marked labeling field on all modular installation devices for uniform, quick and easy identification.

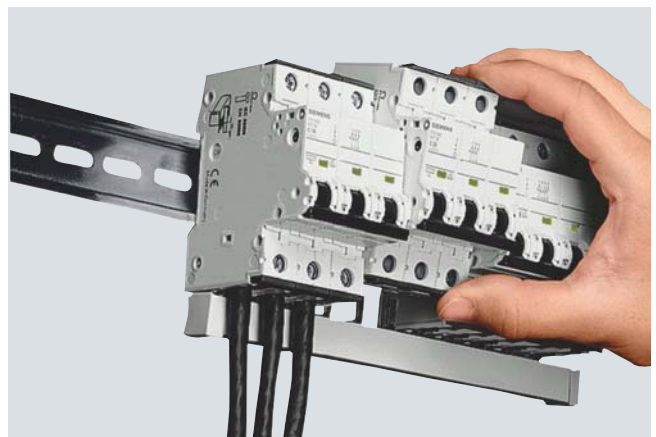

- The MCBs can be quickly and easily removed from the busbar assembly by hand if connections need to be changed.
- Time saving if parts need to be replaced because the busbars no longer need to be freed from the adjacent devices.

## BETA Protecting Miniature Circuit Breakers (MCBs)

Miniature circuit breakers,  
5SP and 5SY

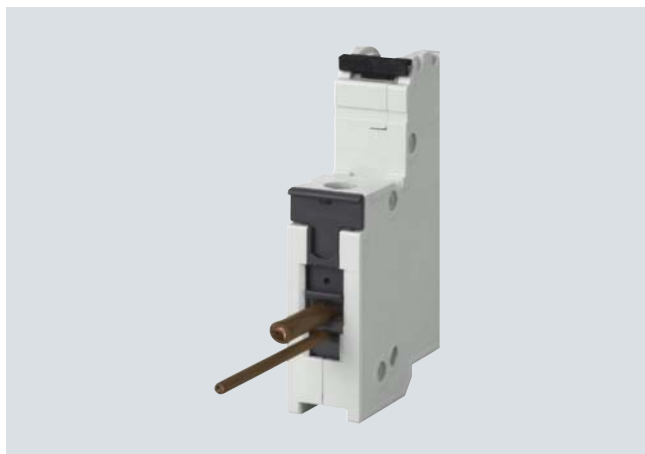

- Double terminal chambers enable 2 conductors of different cross-section to be accommodated (up to 10 mm<sup>2</sup> in the bottom chamber and 35 mm<sup>2</sup> in the top chamber).









- Adapted handle locking device for 5SY, 5SJ and 5SP miniature circuit breakers. Suitable for locks of 3 mm to 6 mm diameter.

# BETA Protecting Miniature Circuit Breakers (MCBs)

Miniature circuit breakers,  
5SP and 5SY

## Selection and ordering data

6 000 3	$I_n$	MW	DT	Characteristic B		PU	PS*	PG	Weight per PU approx. kg
				Order No.	Price per PU				
<b>MCBs 6000 A</b>									
	1P, 230/400 V AC								
	2	1	B	<b>5SY6 102-6</b>		1	1	002	0.165
	4		B	<b>5SY6 104-6</b>		1	1	002	0.165
	6		▶	<b>5SY6 106-6</b>		1	1/12	002	0.165
	10		▶	<b>5SY6 110-6</b>		1	1/12	002	0.165
	13		A	<b>5SY6 113-6</b>		1	1/12	002	0.165
	16		▶	<b>5SY6 116-6</b>		1	1/12	002	0.165
	20		A	<b>5SY6 120-6</b>		1	1/12	002	0.165
	25		A	<b>5SY6 125-6</b>		1	1/12	002	0.165
	32		A	<b>5SY6 132-6</b>		1	1/12	002	0.165
	40		B	<b>5SY6 140-6</b>		1	1	002	0.165
	50		B	<b>5SY6 150-6</b>		1	1	002	0.165
	63		B	<b>5SY6 163-6</b>		1	1	002	0.165
	1P+N, 230 V AC								
	6	2	A	<b>5SY6 506-6</b>		1	1	002	0.330
	10		A	<b>5SY6 510-6</b>		1	1	002	0.330
	13		A	<b>5SY6 513-6</b>		1	1/6	002	0.330
	16		A	<b>5SY6 516-6</b>		1	1/6	002	0.330
	20		B	<b>5SY6 520-6</b>		1	1	002	0.330
	25		B	<b>5SY6 525-6</b>		1	1	002	0.330
	32		B	<b>5SY6 532-6</b>		1	1	002	0.330
	40		C	<b>5SY6 540-6</b>		1	1	002	0.330
63	C		<b>5SY6 550-6</b>		1	1	002	0.330	
	2P, 400 V AC								
	6	2	A	<b>5SY6 206-6</b>		1	1/6	002	0.330
	10		A	<b>5SY6 210-6</b>		1	1/6	002	0.330
	13		B	<b>5SY6 213-6</b>		1	1	002	0.330
	16		A	<b>5SY6 216-6</b>		1	1/6	002	0.330
	20		B	<b>5SY6 220-6</b>		1	1	002	0.330
	25		B	<b>5SY6 225-6</b>		1	1	002	0.330
	32		A	<b>5SY6 232-6</b>		1	1	002	0.330
	40		B	<b>5SY6 240-6</b>		1	1	002	0.330
	50		C	<b>5SY6 250-6</b>		1	1	002	0.330
63	C		<b>5SY6 263-6</b>		1	1	002	0.330	
	3P, 400 V AC								
	6	3	A	<b>5SY6 306-6</b>		1	1	002	0.495
	10		A	<b>5SY6 310-6</b>		1	1/4	002	0.495
	13		B	<b>5SY6 313-6</b>		1	1	002	0.495
	16		▶	<b>5SY6 316-6</b>		1	1/4	002	0.495
	20		A	<b>5SY6 320-6</b>		1	1	002	0.495
	25		A	<b>5SY6 325-6</b>		1	1	002	0.495
	32		A	<b>5SY6 332-6</b>		1	1/4	002	0.495
	40		A	<b>5SY6 340-6</b>		1	1	002	0.495
	50		B	<b>5SY6 350-6</b>		1	1	002	0.495
63	B		<b>5SY6 363-6</b>		1	1	002	0.495	
	3P+N, 400 V AC								
	6	4	B	<b>5SY6 606-6</b>		1	1	002	0.660
	10		B	<b>5SY6 610-6</b>		1	1	002	0.660
	13		B	<b>5SY6 613-6</b>		1	1	002	0.660
	16		A	<b>5SY6 616-6</b>		1	1	002	0.660
	20		A	<b>5SY6 620-6</b>		1	1	002	0.660
	25		B	<b>5SY6 625-6</b>		1	1	002	0.660
	32		B	<b>5SY6 632-6</b>		1	1	002	0.660
	40		C	<b>5SY6 640-6</b>		1	1	002	0.660
	50		C	<b>5SY6 650-6</b>		1	1	002	0.660
63	C		<b>5SY6 663-6</b>		1	1	002	0.660	
	4P, 400 V AC								
	6	4	C	<b>5SY6 406-6</b>		1	1	002	0.660
	10		B	<b>5SY6 410-6</b>		1	1	002	0.660
	13		C	<b>5SY6 413-6</b>		1	1	002	0.660
	16		A	<b>5SY6 416-6</b>		1	1	002	0.660
	20		A	<b>5SY6 420-6</b>		1	1	002	0.660
	25		A	<b>5SY6 425-6</b>		1	1	002	0.660
	32		B	<b>5SY6 432-6</b>		1	1	002	0.660
	40		B	<b>5SY6 440-6</b>		1	1	002	0.660
	50		B	<b>5SY6 450-6</b>		1	1	002	0.660
	63		B	<b>5SY6 463-6</b>		1	1	002	0.660

\* You can order this quantity or a multiple thereof.

# BETA Protecting Miniature Circuit Breakers (MCBs)



Miniature circuit breakers,  
5SP and 5SY

6 000 3				Characteristic C			Characteristic D					
$I_n$	MW	DT	Order No.	Price per PU	PG	DT	Order No.	Price per PU	PU	PS*	PG	Weight per PU approx.
A									Unit(s)	Unit(s)		kg
<b>MCBs 6000 A</b>												
1P, 230/400 V AC												
0.3	1	A	<b>5SY6 114-7</b>		003	C	<b>5SY6 114-8</b>		1	1	004	0.165
0.5		A	<b>5SY6 105-7</b>		003	A	<b>5SY6 105-8</b>		1	1	004	0.165
1		▶	<b>5SY6 101-7</b>		003	A	<b>5SY6 101-8</b>		1	1	004	0.165
1.6		A	<b>5SY6 115-7</b>		003	C	<b>5SY6 115-8</b>		1	1	004	0.147
2		▶	<b>5SY6 102-7</b>		003	A	<b>5SY6 102-8</b>		1	1/12	004	0.165
3		A	<b>5SY6 103-7</b>		003	A	<b>5SY6 103-8</b>		1	1	004	0.165
4		▶	<b>5SY6 104-7</b>		003	A	<b>5SY6 104-8</b>		1	1	004	0.165
6		▶	<b>5SY6 106-7</b>		003	A	<b>5SY6 106-8</b>		1	1/12	004	0.165
8		A	<b>5SY6 108-7</b>		003	A	<b>5SY6 108-8</b>		1	1	004	0.165
10		▶	<b>5SY6 110-7</b>		003	A	<b>5SY6 110-8</b>		1	1	004	0.165
13		A	<b>5SY6 113-7</b>		003	A	<b>5SY6 113-8</b>		1	1	004	0.165
16		▶	<b>5SY6 116-7</b>		003	A	<b>5SY6 116-8</b>		1	1	004	0.165
20		▶	<b>5SY6 120-7</b>		003	A	<b>5SY6 120-8</b>		1	1	004	0.165
25		▶	<b>5SY6 125-7</b>		003	A	<b>5SY6 125-8</b>		1	1	004	0.165
32		▶	<b>5SY6 132-7</b>		003	B	<b>5SY6 132-8</b>		1	1	004	0.165
40		A	<b>5SY6 140-7</b>		003	B	<b>5SY6 140-8</b>		1	1	004	0.165
50		A	<b>5SY6 150-7</b>		003	B	<b>5SY6 150-8</b>		1	1	004	0.165
63		A	<b>5SY6 163-7</b>		003	B	<b>5SY6 163-8</b>		1	1	004	0.165
1P+N, 230 V AC												
0.3	2	B	<b>5SY6 514-7</b>		003	C	<b>5SY6 514-8</b>		1	1	004	0.330
0.5		A	<b>5SY6 505-7</b>		003	B	<b>5SY6 505-8</b>		1	1	004	0.330
1		A	<b>5SY6 501-7</b>		003	C	<b>5SY6 501-8</b>		1	1	004	0.330
1.6		B	<b>5SY6 515-7</b>		003	B	<b>5SY6 515-8</b>		1	1	004	0.330
2		A	<b>5SY6 502-7</b>		003	B	<b>5SY6 502-8</b>		1	1	004	0.330
3		A	<b>5SY6 503-7</b>		003	B	<b>5SY6 503-8</b>		1	1	004	0.330
4		A	<b>5SY6 504-7</b>		003	B	<b>5SY6 504-8</b>		1	1	004	0.330
6		A	<b>5SY6 506-7</b>		003	A	<b>5SY6 506-8</b>		1	1	004	0.330
8		B	<b>5SY6 508-7</b>		003	B	<b>5SY6 508-8</b>		1	1	004	0.330
10		A	<b>5SY6 510-7</b>		003	B	<b>5SY6 510-8</b>		1	1	004	0.330
13		A	<b>5SY6 513-7</b>		003	C	<b>5SY6 513-8</b>		1	1	004	0.330
16		▶	<b>5SY6 516-7</b>		003	A	<b>5SY6 516-8</b>		1	1	004	0.330
20		A	<b>5SY6 520-7</b>		003	C	<b>5SY6 520-8</b>		1	1	004	0.330
25		A	<b>5SY6 525-7</b>		003	C	<b>5SY6 525-8</b>		1	1	004	0.330
32		A	<b>5SY6 532-7</b>		003	C	<b>5SY6 532-8</b>		1	1	004	0.330
40		B	<b>5SY6 540-7</b>		003	C	<b>5SY6 540-8</b>		1	1	004	0.330
50		B	<b>5SY6 550-7</b>		003	C	<b>5SY6 550-8</b>		1	1	004	0.330
63		B	<b>5SY6 563-7</b>		003	C	<b>5SY6 563-8</b>		1	1	004	0.330
2P, 400 V AC												
0.3	2	B	<b>5SY6 214-7</b>		003	B	<b>5SY6 214-8</b>		1	1	004	0.330
0.5		A	<b>5SY6 205-7</b>		003	A	<b>5SY6 205-8</b>		1	1	004	0.330
1		A	<b>5SY6 201-7</b>		003	A	<b>5SY6 201-8</b>		1	1	004	0.330
1.6		A	<b>5SY6 215-7</b>		003	A	<b>5SY6 215-8</b>		1	1	004	0.330
2		▶	<b>5SY6 202-7</b>		003	A	<b>5SY6 202-8</b>		1	1/6	004	0.330
3		A	<b>5SY6 203-7</b>		003	A	<b>5SY6 203-8</b>		1	1	004	0.330
4		▶	<b>5SY6 204-7</b>		003	A	<b>5SY6 204-8</b>		1	1/6	004	0.330
6		▶	<b>5SY6 206-7</b>		003	A	<b>5SY6 206-8</b>		1	1/6	004	0.330
8		A	<b>5SY6 208-7</b>		003	A	<b>5SY6 208-8</b>		1	1	004	0.330
10		▶	<b>5SY6 210-7</b>		003	A	<b>5SY6 210-8</b>		1	1/6	004	0.330
13		A	<b>5SY6 213-7</b>		003	B	<b>5SY6 213-8</b>		1	1	004	0.330
16		▶	<b>5SY6 216-7</b>		003	A	<b>5SY6 216-8</b>		1	1	004	0.330
20		▶	<b>5SY6 220-7</b>		003	A	<b>5SY6 220-8</b>		1	1	004	0.330
25		A	<b>5SY6 225-7</b>		003	A	<b>5SY6 225-8</b>		1	1	004	0.330
32		A	<b>5SY6 232-7</b>		003	A	<b>5SY6 232-8</b>		1	1	004	0.330
40		A	<b>5SY6 240-7</b>		003	B	<b>5SY6 240-8</b>		1	1	004	0.330
50		A	<b>5SY6 250-7</b>		003	B	<b>5SY6 250-8</b>		1	1	004	0.330
63		A	<b>5SY6 263-7</b>		003	B	<b>5SY6 263-8</b>		1	1	004	0.330

\* You can order this quantity or a multiple thereof.

# BETA Protecting Miniature Circuit Breakers (MCBs)

Miniature circuit breakers,  
5SP and 5SY



6 000				Characteristic C			Characteristic D					
$I_n$	MW	DT	Order No.	Price per PU	PG	DT	Order No.	Price per PU	PU	PS*	PG	Weight per PU approx.
A									Unit(s)	Unit(s)		kg
<b>MCBs 6000 A</b>												
3P, 400 V AC												
	0.3	3	C	5SY6 314-7		003 C	5SY6 314-8		1	1	004	0.495
	0.5		A	5SY6 305-7		003 C	5SY6 305-8		1	1	004	0.495
	1		A	5SY6 301-7		003 A	5SY6 301-8		1	1	004	0.495
	1.6		B	5SY6 315-7		003 C	5SY6 315-8		1	1	004	0.495
	2		A	5SY6 302-7		003 A	5SY6 302-8		1	1	004	0.495
	3		A	5SY6 303-7		003 A	5SY6 303-8		1	1	004	0.495
	4		A	5SY6 304-7		003 A	5SY6 304-8		1	1	004	0.495
	6		▶	5SY6 306-7		003 A	5SY6 306-8		1	1	004	0.495
	8		A	5SY6 308-7		003 B	5SY6 308-8		1	1	004	0.495
	10		▶	5SY6 310-7		003 A	5SY6 310-8		1	1	004	0.495
	13		A	5SY6 313-7		003 B	5SY6 313-8		1	1	004	0.495
	16		▶	5SY6 316-7		003 A	5SY6 316-8		1	1	004	0.495
	20		▶	5SY6 320-7		003 A	5SY6 320-8		1	1	004	0.495
	25		▶	5SY6 325-7		003 A	5SY6 325-8		1	1	004	0.495
	32		▶	5SY6 332-7		003 A	5SY6 332-8		1	1	004	0.495
	40		A	5SY6 340-7		003 A	5SY6 340-8		1	1	004	0.495
50		A	5SY6 350-7		003 A	5SY6 350-8		1	1	004	0.495	
63		A	5SY6 363-7		003 A	5SY6 363-8		1	1	004	0.495	
3P+N, 400 V AC												
	0.3	4	C	5SY6 614-7		003 C	5SY6 614-8		1	1	004	0.660
	0.5		C	5SY6 605-7		003 C	5SY6 605-8		1	1	004	0.660
	1		C	5SY6 601-7		003 C	5SY6 601-8		1	1	004	0.660
	1.6		C	5SY6 615-7		003 C	5SY6 615-8		1	1	004	0.660
	2		A	5SY6 602-7		003 C	5SY6 602-8		1	1	004	0.660
	3		C	5SY6 603-7		003 C	5SY6 603-8		1	1	004	0.660
	4		B	5SY6 604-7		003 C	5SY6 604-8		1	1	004	0.660
	6		A	5SY6 606-7		003 A	5SY6 606-8		1	1	004	0.660
	8		C	5SY6 608-7		003 C	5SY6 608-8		1	1	004	0.660
	10		A	5SY6 610-7		003 B	5SY6 610-8		1	1	004	0.660
	13		B	5SY6 613-7		003 C	5SY6 613-8		1	1	004	0.660
	16		▶	5SY6 616-7		003 B	5SY6 616-8		1	1	004	0.660
	20		A	5SY6 620-7		003 B	5SY6 620-8		1	1	004	0.660
	25		A	5SY6 625-7		003 B	5SY6 625-8		1	1	004	0.660
	32		A	5SY6 632-7		003 B	5SY6 632-8		1	1	004	0.660
	40		A	5SY6 640-7		003 B	5SY6 640-8		1	1	004	0.660
50		A	5SY6 650-7		003 B	5SY6 650-8		1	1	004	0.660	
63		A	5SY6 663-7		003 B	5SY6 663-8		1	1	004	0.660	
4P, 400 V AC												
	0.3	4	C	5SY6 414-7		003 C	5SY6 414-8		1	1	004	0.660
	0.5		C	5SY6 405-7		003 C	5SY6 405-8		1	1	004	0.660
	1		B	5SY6 401-7		003 C	5SY6 401-8		1	1	004	0.660
	1.6		C	5SY6 415-7		003 C	5SY6 415-8		1	1	004	0.660
	2		A	5SY6 402-7		003 C	5SY6 402-8		1	1	004	0.660
	3		B	5SY6 403-7		003 C	5SY6 403-8		1	1	004	0.660
	4		B	5SY6 404-7		003 C	5SY6 404-8		1	1	004	0.660
	6		A	5SY6 406-7		003 B	5SY6 406-8		1	1	004	0.660
	8		B	5SY6 408-7		003 C	5SY6 408-8		1	1	004	0.660
	10		A	5SY6 410-7		003 A	5SY6 410-8		1	1	004	0.660
	13		A	5SY6 413-7		003 C	5SY6 413-8		1	1	004	0.660
	16		▶	5SY6 416-7		003 A	5SY6 416-8		1	1	004	0.660
	20		A	5SY6 420-7		003 A	5SY6 420-8		1	1	004	0.660
	25		▶	5SY6 425-7		003 A	5SY6 425-8		1	1	004	0.660
	32		▶	5SY6 432-7		003 A	5SY6 432-8		1	1	004	0.660
	40		▶	5SY6 440-7		003 A	5SY6 440-8		1	1	004	0.660
50		A	5SY6 450-7		003 A	5SY6 450-8		1	1	004	0.660	
63		A	5SY6 463-7		003 ▶	5SY6 463-8		1	1	004	0.660	

\* You can order this quantity or a multiple thereof.



# BETA Protecting Miniature Circuit Breakers (MCBs)



Miniature circuit breakers,  
5SP and 5SY

10 000 3	$I_n$	MW	DT	Characteristic A			Characteristic B			PU	PS*	PG	Weight per PU approx. kg
				Order No.	Price per PU	PG DT	Order No.	Price per PU	Unit(s)				
<b>MCBs 10000 A</b>													
1P, 230/400 V AC													
	0.5	1	C	<b>5SY4 105-5</b>		001	--			1	1	0.165	
	1		A	<b>5SY4 101-5</b>		001	--			1	1	0.165	
	1.6		B	<b>5SY4 115-5</b>		001	--			1	1	0.165	
	2		A	<b>5SY4 102-5</b>		001	--			1	1	0.165	
	3		A	<b>5SY4 103-5</b>		001	--			1	1	0.165	
	4		A	<b>5SY4 104-5</b>		001	--			1	1/12	0.165	
	6		A	<b>5SY4 106-5</b>		001	A	<b>5SY4 106-6</b>		1	1/12	0.165	
	8		B	<b>5SY4 108-5</b>		001	--			1	1	0.165	
	10		A	<b>5SY4 110-5</b>		001	▶	<b>5SY4 110-6</b>		1	1/12	0.165	
	13		C	<b>5SY4 113-5</b>		001	A	<b>5SY4 113-6</b>		1	1	0.165	
	16		A	<b>5SY4 116-5</b>		001	▶	<b>5SY4 116-6</b>		1	1/12	0.165	
	20		A	<b>5SY4 120-5</b>		001	A	<b>5SY4 120-6</b>		1	1	0.165	
	25		A	<b>5SY4 125-5</b>		001	▶	<b>5SY4 125-6</b>		1	1	0.165	
	32		B	<b>5SY4 132-5</b>		001	A	<b>5SY4 132-6</b>		1	1	0.165	
	40		B	<b>5SY4 140-5</b>		001	B	<b>5SY4 140-6</b>		1	1	0.165	
	50		C	<b>5SY4 150-5</b>		001	B	<b>5SY4 150-6</b>		1	1	0.165	
	63		C	<b>5SY4 163-5</b>		001	B	<b>5SY4 163-6</b>		1	1	0.165	
	80		--	--			C	<b>5SY4 180-6</b>		1	1	0.162	
1P+N, 230 V AC													
	1	2	C	<b>5SY4 501-5</b>		001	--			1	1	0.330	
	1.6		B	<b>5SY4 515-5</b>		001	--			1	1	0.330	
	2		B	<b>5SY4 502-5</b>		001	--			1	1	0.330	
	3		C	<b>5SY4 503-5</b>		001	--			1	1	0.330	
	4		B	<b>5SY4 504-5</b>		001	--			1	1	0.330	
	6		C	<b>5SY4 506-5</b>		001	A	<b>5SY4 506-6</b>		1	1	0.330	
	8		C	<b>5SY4 508-5</b>		001	--			1	1	0.330	
	10		B	<b>5SY4 510-5</b>		001	A	<b>5SY4 510-6</b>		1	1	0.330	
	13		C	<b>5SY4 513-5</b>		001	A	<b>5SY4 513-6</b>		1	1/6	0.330	
	16		C	<b>5SY4 516-5</b>		001	A	<b>5SY4 516-6</b>		1	1/6	0.330	
	20		C	<b>5SY4 520-5</b>		001	B	<b>5SY4 520-6</b>		1	1	0.330	
	25		C	<b>5SY4 525-5</b>		001	B	<b>5SY4 525-6</b>		1	1	0.330	
	32		C	<b>5SY4 532-5</b>		001	B	<b>5SY4 532-6</b>		1	1	0.330	
	40		C	<b>5SY4 540-5</b>		001	C	<b>5SY4 540-6</b>		1	1	0.330	
	50		C	<b>5SY4 550-5</b>		001	C	<b>5SY4 550-6</b>		1	1	0.330	
	63		C	<b>5SY4 563-5</b>		001	C	<b>5SY4 563-6</b>		1	1	0.330	
2P, 400 V AC													
	0.5	2	C	<b>5SY4 205-5</b>		001	--			1	1	0.330	
	1		B	<b>5SY4 201-5</b>		001	--			1	1	0.330	
	1.6		B	<b>5SY4 215-5</b>		001	--			1	1	0.330	
	2		A	<b>5SY4 202-5</b>		001	--			1	1	0.330	
	3		B	<b>5SY4 203-5</b>		001	--			1	1	0.330	
	4		A	<b>5SY4 204-5</b>		001	--			1	1	0.330	
	6		A	<b>5SY4 206-5</b>		001	A	<b>5SY4 206-6</b>		1	1	0.330	
	8		C	<b>5SY4 208-5</b>		001	--			1	1	0.330	
	10		A	<b>5SY4 210-5</b>		001	A	<b>5SY4 210-6</b>		1	1/6	0.330	
	13		C	<b>5SY4 213-5</b>		001	B	<b>5SY4 213-6</b>		1	1	0.330	
	16		A	<b>5SY4 216-5</b>		001	▶	<b>5SY4 216-6</b>		1	1/6	0.330	
	20		B	<b>5SY4 220-5</b>		001	A	<b>5SY4 220-6</b>		1	1	0.330	
	25		B	<b>5SY4 225-5</b>		001	A	<b>5SY4 225-6</b>		1	1	0.330	
	32		A	<b>5SY4 232-5</b>		001	B	<b>5SY4 232-6</b>		1	1	0.330	
	40		B	<b>5SY4 240-5</b>		001	B	<b>5SY4 240-6</b>		1	1	0.330	
	50		C	<b>5SY4 250-5</b>		001	B	<b>5SY4 250-6</b>		1	1	0.330	
	63		C	<b>5SY4 263-5</b>		001	B	<b>5SY4 263-6</b>		1	1	0.330	
	80		--	--			C	<b>5SY4 280-6</b>		1	1	0.324	

\* You can order this quantity or a multiple thereof.

# BETA Protecting Miniature Circuit Breakers (MCBs)

Miniature circuit breakers,  
5SP and 5SY

10 000 3				Characteristic A			Characteristic B						
$I_n$	MW	DT	Order No.	Price per PU	PG	DT	Order No.	Price per PU	PU	PS*	PG	Weight per PU approx.	
									Unit(s)	Unit(s)			kg
<b>MCBs 10000 A</b>													
3P, 400 V AC													
	0.5	3	C	<b>5SY4 305-5</b>			001	--	1	1		0.495	
	1		C	<b>5SY4 301-5</b>			001	--	1	1		0.495	
	1.6		C	<b>5SY4 315-5</b>			001	--	1	1		0.495	
	2		B	<b>5SY4 302-5</b>			001	--	1	1		0.495	
	3		C	<b>5SY4 303-5</b>			001	--	1	1		0.495	
	4		B	<b>5SY4 304-5</b>			001	--	1	1		0.495	
	6		B	<b>5SY4 306-5</b>			001	A	1	1	002	0.495	
	8		C	<b>5SY4 308-5</b>			001	--	1	1		0.495	
	10		B	<b>5SY4 310-5</b>			001	▶	1	1	002	0.495	
	13		C	<b>5SY4 313-5</b>			001	B	1	1	002	0.495	
	16		A	<b>5SY4 316-5</b>			001	▶	1	1/4	002	0.495	
	20		B	<b>5SY4 320-5</b>			001	A	1	1	002	0.495	
	25		B	<b>5SY4 325-5</b>			001	A	1	1	002	0.495	
	32		B	<b>5SY4 332-5</b>			001	▶	1	1/4	002	0.495	
	40		B	<b>5SY4 340-5</b>			001	A	1	1	002	0.495	
	50		B	<b>5SY4 350-5</b>			001	A	1	1	002	0.495	
	63		C	<b>5SY4 363-5</b>			001	A	1	1	002	0.495	
	80		--	--				B	1	1	002	0.486	
3P+N, 400 V AC													
	1	4	C	<b>5SY4 601-5</b>			001	--	1	1		0.660	
	1.6		C	<b>5SY4 615-5</b>			001	--	1	1		0.660	
	2		C	<b>5SY4 602-5</b>			001	--	1	1		0.660	
	3		C	<b>5SY4 603-5</b>			001	--	1	1		0.660	
	4		C	<b>5SY4 604-5</b>			001	--	1	1		0.660	
	6		C	<b>5SY4 606-5</b>			001	B	1	1	002	0.660	
	8		C	<b>5SY4 608-5</b>			001	--	1	1		0.660	
	10		C	<b>5SY4 610-5</b>			001	B	1	1	002	0.660	
	13		C	<b>5SY4 613-5</b>			001	C	1	1	002	0.660	
	16		C	<b>5SY4 616-5</b>			001	A	1	1	002	0.660	
	20		C	<b>5SY4 620-5</b>			001	B	1	1	002	0.660	
	25		C	<b>5SY4 625-5</b>			001	A	1	1	002	0.660	
	32		C	<b>5SY4 632-5</b>			001	B	1	1	002	0.660	
	40		C	<b>5SY4 640-5</b>			001	C	1	1	002	0.660	
	50		C	<b>5SY4 650-5</b>			001	C	1	1	002	0.660	
	63		C	<b>5SY4 663-5</b>			001	A	1	1	002	0.660	
4P, 400 V AC													
	1	4	C	<b>5SY4 401-5</b>			001	--	1	1		0.660	
	1.6		C	<b>5SY4 415-5</b>			001	--	1	1		0.660	
	2		C	<b>5SY4 402-5</b>			001	--	1	1		0.660	
	3		C	<b>5SY4 403-5</b>			001	--	1	1		0.660	
	4		C	<b>5SY4 404-5</b>			001	--	1	1		0.660	
	6		C	<b>5SY4 406-5</b>			001	A	1	1	002	0.660	
	8		C	<b>5SY4 408-5</b>			001	--	1	1		0.660	
	10		C	<b>5SY4 410-5</b>			001	B	1	1	002	0.660	
	13		C	<b>5SY4 413-5</b>			001	C	1	1	002	0.660	
	16		C	<b>5SY4 416-5</b>			001	A	1	1	002	0.660	
	20		C	<b>5SY4 420-5</b>			001	C	1	1	002	0.660	
	25		C	<b>5SY4 425-5</b>			001	B	1	1	002	0.660	
	32		C	<b>5SY4 432-5</b>			001	B	1	1	002	0.660	
	40		C	<b>5SY4 440-5</b>			001	B	1	1	002	0.660	
	50		C	<b>5SY4 450-5</b>			001	B	1	1	002	0.660	
	63		C	<b>5SY4 463-5</b>			001	B	1	1	002	0.660	
	80		--	--				B	1	1	002	0.648	

\* You can order this quantity or a multiple thereof.

# BETA Protecting Miniature Circuit Breakers (MCBs)



Miniature circuit breakers,  
5SP and 5SY

10 000 3				Characteristic C				Characteristic D					
$I_n$	MW	DT	Order No.	Price per PU	PG	DT	Order No.	Price per PU	PU	PS*	PG	Weight per PU approx.	
A									Unit(s)	Unit(s)		kg	
<b>MCBs 10000 A</b>													
1P, 230/400 V AC													
0.3	1	B	5SY4 114-7		003	C	5SY4 114-8		1	1	004	0.165	
0.5		A	5SY4 105-7		003	B	5SY4 105-8		1	1	004	0.165	
1		▶	5SY4 101-7		003	A	5SY4 101-8		1	1	004	0.165	
1.6		A	5SY4 115-7		003	B	5SY4 115-8		1	1	004	0.165	
2		▶	5SY4 102-7		003	A	5SY4 102-8		1	1/12	004	0.165	
3		A	5SY4 103-7		003	A	5SY4 103-8		1	1	004	0.165	
4		▶	5SY4 104-7		003	A	5SY4 104-8		1	1/12	004	0.165	
5		C	5SY4 111-7		003		--		1	1		0.165	
6		▶	5SY4 106-7		003	A	5SY4 106-8		1	1	004	0.165	
8		A	5SY4 108-7		003	A	5SY4 108-8		1	1	004	0.165	
10		▶	5SY4 110-7		003	A	5SY4 110-8		1	1/12	004	0.165	
13		A	5SY4 113-7		003	B	5SY4 113-8		1	1	004	0.165	
15		C	5SY4 118-7		003		--		1	1		0.165	
16		▶	5SY4 116-7		003	A	5SY4 116-8		1	1	004	0.165	
20		▶	5SY4 120-7		003	A	5SY4 120-8		1	1	004	0.165	
25		▶	5SY4 125-7		003	B	5SY4 125-8		1	1	004	0.165	
30		B	5SY4 130-7		003		--		1	1		0.165	
32		▶	5SY4 132-7		003	B	5SY4 132-8		1	1	004	0.165	
35		B	5SY4 135-7		003		--		1	1		0.165	
40		A	5SY4 140-7		003	B	5SY4 140-8		1	1	004	0.165	
45		B	5SY4 145-7		003		--		1	1		0.165	
50		A	5SY4 150-7		003	B	5SY4 150-8		1	1	004	0.165	
60		B	5SY4 160-7		003		--		1	1		0.165	
63		B	5SY4 163-7		003	B	5SY4 163-8		1	1	004	0.165	
80		B	5SY4 180-7		003		--		1	1		0.161	
1P+N, 230 V AC													
0.3	2	C	5SY4 514-7		003	C	5SY4 514-8		1	1	004	0.330	
0.5		B	5SY4 505-7		003	C	5SY4 505-8		1	1	004	0.330	
1		A	5SY4 501-7		003	B	5SY4 501-8		1	1	004	0.330	
1.6		C	5SY4 515-7		003	C	5SY4 515-8		1	1	004	0.330	
2		A	5SY4 502-7		003	A	5SY4 502-8		1	1	004	0.330	
3		A	5SY4 503-7		003	B	5SY4 503-8		1	1	004	0.330	
4		A	5SY4 504-7		003	B	5SY4 504-8		1	1	004	0.330	
6		A	5SY4 506-7		003	A	5SY4 506-8		1	1	004	0.330	
8		B	5SY4 508-7		003	C	5SY4 508-8		1	1	004	0.330	
10		A	5SY4 510-7		003	A	5SY4 510-8		1	1	004	0.330	
13		A	5SY4 513-7		003	B	5SY4 513-8		1	1	004	0.330	
16		A	5SY4 516-7		003	A	5SY4 516-8		1	1	004	0.330	
20		A	5SY4 520-7		003	B	5SY4 520-8		1	1	004	0.330	
25		A	5SY4 525-7		003	B	5SY4 525-8		1	1	004	0.330	
32		A	5SY4 532-7		003	B	5SY4 532-8		1	1	004	0.330	
40		B	5SY4 540-7		003	C	5SY4 540-8		1	1	004	0.330	
50		C	5SY4 550-7		003	C	5SY4 550-8		1	1	004	0.330	
63		C	5SY4 563-7		003	C	5SY4 563-8		1	1	004	0.330	
80		B	5SY4 580-7		003		--		1	1		0.323	
2P, 400 V AC													
0.3	2	A	5SY4 214-7		003	B	5SY4 214-8		1	1	004	0.330	
0.5		A	5SY4 205-7		003	A	5SY4 205-8		1	1	004	0.330	
1		A	5SY4 201-7		003	A	5SY4 201-8		1	1	004	0.330	
1.6		A	5SY4 215-7		003	A	5SY4 215-8		1	1	004	0.330	
2		A	5SY4 202-7		003	A	5SY4 202-8		1	1	004	0.330	
3		A	5SY4 203-7		003	A	5SY4 203-8		1	1	004	0.330	
4		A	5SY4 204-7		003	A	5SY4 204-8		1	1	004	0.330	
5		C	5SY4 211-7		003		--		1	1		0.330	
6		A	5SY4 206-7		003	A	5SY4 206-8		1	1	004	0.330	
8		A	5SY4 208-7		003	A	5SY4 208-8		1	1	004	0.330	
10		▶	5SY4 210-7		003	A	5SY4 210-8		1	1	004	0.330	
13		A	5SY4 213-7		003	A	5SY4 213-8		1	1	004	0.330	
15		C	5SY4 218-7		003		--		1	1		0.330	
16		▶	5SY4 216-7		003	A	5SY4 216-8		1	1	004	0.330	
20		A	5SY4 220-7		003	A	5SY4 220-8		1	1	004	0.330	
25		A	5SY4 225-7		003	A	5SY4 225-8		1	1	004	0.330	
30		C	5SY4 230-7		003		--		1	1		0.330	
32		A	5SY4 232-7		003	A	5SY4 232-8		1	1	004	0.330	
35		B	5SY4 235-7		003		--		1	1		0.330	
40		A	5SY4 240-7		003	A	5SY4 240-8		1	1	004	0.330	
45		B	5SY4 245-7		003		--		1	1		0.330	
50		A	5SY4 250-7		003	B	5SY4 250-8		1	1	004	0.330	
60		B	5SY4 260-7		003		--		1	1		0.330	
63		A	5SY4 263-7		003	B	5SY4 263-8		1	1	004	0.330	
80		B	5SY4 280-7		003		--		1	1/6		0.323	

\* You can order this quantity or a multiple thereof.

# BETA Protecting Miniature Circuit Breakers (MCBs)

Miniature circuit breakers,  
5SP and 5SY

10 000 3				Characteristic C			Characteristic D					
$I_n$	MW	DT	Order No.	Price per PU	PG	DT	Order No.	Price per PU	PU	PS*	PG	Weight per PU approx.
A									Unit(s)	Unit(s)		kg
<b>MCBs 10000 A</b>												
3P, 400 V AC												
	0.3	3	C	5SY4 314-7		003	C	5SY4 314-8	1	1	004	0.495
	0.5		B	5SY4 305-7		003	B	5SY4 305-8	1	1	004	0.495
	1		A	5SY4 301-7		003	A	5SY4 301-8	1	1	004	0.495
	1.6		C	5SY4 315-7		003	B	5SY4 315-8	1	1	004	0.495
	2		A	5SY4 302-7		003	A	5SY4 302-8	1	1	004	0.495
	3		A	5SY4 303-7		003	A	5SY4 303-8	1	1	004	0.495
	4		A	5SY4 304-7		003	A	5SY4 304-8	1	1	004	0.495
	5		C	5SY4 311-7		003		--	1	1		0.495
	6		▶	5SY4 306-7		003	A	5SY4 306-8	1	1	004	0.495
	8		A	5SY4 308-7		003	B	5SY4 308-8	1	1	004	0.495
	10		▶	5SY4 310-7		003	A	5SY4 310-8	1	1	004	0.495
	13		A	5SY4 313-7		003	B	5SY4 313-8	1	1	004	0.495
	15		C	5SY4 318-7		003		--	1	1		0.495
	16		▶	5SY4 316-7		003	A	5SY4 316-8	1	1/4	004	0.495
	20		▶	5SY4 320-7		003	A	5SY4 320-8	1	1	004	0.495
	25		▶	5SY4 325-7		003	A	5SY4 325-8	1	1	004	0.495
	30		C	5SY4 330-7		003		--	1	1		0.495
	32		▶	5SY4 332-7		003	A	5SY4 332-8	1	1	004	0.495
	35		C	5SY4 335-7		003		--	1	1		0.495
	40		A	5SY4 340-7		003	A	5SY4 340-8	1	1	004	0.495
	45		B	5SY4 345-7		003		--	1	1		0.495
	50		A	5SY4 350-7		003	A	5SY4 350-8	1	1	004	0.495
	60		C	5SY4 360-7		003		--	1	1		0.495
	63		A	5SY4 363-7		003	A	5SY4 363-8	1	1	004	0.495
	80		B	5SY4 380-7		003		--	1	1		0.482
<b>3P+N, 400 V AC</b>												
	0.3	4	C	5SY4 614-7		003	C	5SY4 614-8	1	1	004	0.660
	0.5		C	5SY4 605-7		003	C	5SY4 605-8	1	1	004	0.660
	1		C	5SY4 601-7		003	C	5SY4 601-8	1	1	004	0.660
	1.6		C	5SY4 615-7		003	C	5SY4 615-8	1	1	004	0.660
	2		B	5SY4 602-7		003	C	5SY4 602-8	1	1	004	0.660
	3		B	5SY4 603-7		003	C	5SY4 603-8	1	1	004	0.660
	4		C	5SY4 604-7		003	C	5SY4 604-8	1	1	004	0.660
	6		B	5SY4 606-7		003	C	5SY4 606-8	1	1	004	0.660
	8		C	5SY4 608-7		003	C	5SY4 608-8	1	1	004	0.660
	10		A	5SY4 610-7		003	B	5SY4 610-8	1	1	004	0.660
	13		B	5SY4 613-7		003	C	5SY4 613-8	1	1	004	0.660
	16		A	5SY4 616-7		003	A	5SY4 616-8	1	1	004	0.660
	20		A	5SY4 620-7		003	B	5SY4 620-8	1	1	004	0.660
	25		A	5SY4 625-7		003	A	5SY4 625-8	1	1	004	0.660
	32		A	5SY4 632-7		003	A	5SY4 632-8	1	1	004	0.660
	40		A	5SY4 640-7		003	A	5SY4 640-8	1	1	004	0.660
	50		B	5SY4 650-7		003	A	5SY4 650-8	1	1	004	0.660
	63		A	5SY4 663-7		003	B	5SY4 663-8	1	1	004	0.660
	80		B	5SY4 680-7		003		--	1	1		0.647
<b>4P, 400 V AC</b>												
	0.3	4	C	5SY4 414-7		003	C	5SY4 414-8	1	1	004	0.660
	0.5		C	5SY4 405-7		003	C	5SY4 405-8	1	1	004	0.660
	1		C	5SY4 401-7		003	C	5SY4 401-8	1	1	004	0.660
	1.6		C	5SY4 415-7		003	C	5SY4 415-8	1	1	004	0.660
	2		B	5SY4 402-7		003	C	5SY4 402-8	1	1	004	0.660
	3		C	5SY4 403-7		003	C	5SY4 403-8	1	1	004	0.660
	4		B	5SY4 404-7		003	C	5SY4 404-8	1	1	004	0.660
	6		A	5SY4 406-7		003	B	5SY4 406-8	1	1	004	0.660
	8		C	5SY4 408-7		003	C	5SY4 408-8	1	1	004	0.660
	10		A	5SY4 410-7		003	A	5SY4 410-8	1	1	004	0.660
	13		C	5SY4 413-7		003	C	5SY4 413-8	1	1	004	0.660
	16		A	5SY4 416-7		003	▶	5SY4 416-8	1	1	004	0.660
	20		A	5SY4 420-7		003	A	5SY4 420-8	1	1	004	0.660
	25		A	5SY4 425-7		003	A	5SY4 425-8	1	1	004	0.660
	32		A	5SY4 432-7		003	▶	5SY4 432-8	1	1	004	0.660
	40		A	5SY4 440-7		003	A	5SY4 440-8	1	1	004	0.660
	50		A	5SY4 450-7		003	A	5SY4 450-8	1	1	004	0.660
	63		A	5SY4 463-7		003	A	5SY4 463-8	1	1	004	0.660
	80		B	5SY4 480-7		003		--	1	1		0.647

\* You can order this quantity or a multiple thereof.

# BETA Protecting Miniature Circuit Breakers (MCBs)

Miniature circuit breakers,  
5SP and 5SY





10 000		$I_n$	MW	DT	Characteristic B		Price per PU	PU	PS*	PG	Weight per PU approx.	
		A			Order No.			Unit(s)	Unit(s)		kg	
	<b>MCBs 10000 A, high current</b>											
	1P, 230/400 V AC											
	80	1.5		B	<b>5SP4 180-6</b>			1	1	002	0.258	
	100			C	<b>5SP4 191-6</b>			1	1	002	0.258	
	125			B	<b>5SP4 192-6</b>			1	1	002	0.258	
	2P, 400 V AC											
	80	3		C	<b>5SP4 280-6</b>			1	1	002	0.516	
	100			C	<b>5SP4 291-6</b>			1	1	002	0.516	
	125			C	<b>5SP4 292-6</b>			1	1	002	0.516	
3P, 400 V AC												
80	4.5		B	<b>5SP4 380-6</b>			1	1	002	0.762		
100			B	<b>5SP4 391-6</b>			1	1	002	0.762		
125			C	<b>5SP4 392-6</b>			1	1	002	0.762		
4P, 400 V AC												
80	6		B	<b>5SP4 480-6</b>			1	1	002	1.032		
100			C	<b>5SP4 491-6</b>			1	1	002	1.032		
125			C	<b>5SP4 492-6</b>			1	1	002	1.032		

10 000		$I_n$	MW	DT	Characteristic C		Price per PU	PG	DT	Characteristic D		Price per PU	PU	PS*	PG	Weight per PU approx.
		A			Order No.					Order No.			Unit(s)	Unit(s)		kg
	<b>MCBs 10000 A, high current</b>															
	1P, 230/400 V AC															
	80	1.5	A		<b>5SP4 180-7</b>			003	B	<b>5SP4 180-8</b>			1	1	004	0.258
	100		A		<b>5SP4 191-7</b>			003	C	<b>5SP4 191-8</b>			1	1	004	0.258
	125		A		<b>5SP4 192-7</b>			003	--				1	1		0.258
	2P, 400 V AC															
	80	3	A		<b>5SP4 280-7</b>			003	C	<b>5SP4 280-8</b>			1	1	004	0.516
	100		A		<b>5SP4 291-7</b>			003	C	<b>5SP4 291-8</b>			1	1	004	0.516
	125		A		<b>5SP4 292-7</b>			003	--				1	1		0.516
3P, 400 V AC																
80	4.5	A		<b>5SP4 380-7</b>			003	A	<b>5SP4 380-8</b>			1	1	004	0.762	
100		A		<b>5SP4 391-7</b>			003	A	<b>5SP4 391-8</b>			1	1	004	0.762	
125		A		<b>5SP4 392-7</b>			003	--				1	1		0.762	
4P, 400 V AC																
80	6	A		<b>5SP4 480-7</b>			003	A	<b>5SP4 480-8</b>			1	1	004	1.032	
100		A		<b>5SP4 491-7</b>			003	C	<b>5SP4 491-8</b>			1	1	004	1.032	
125		A		<b>5SP4 492-7</b>			003	--				1	1		1.032	

\* You can order this quantity or a multiple thereof.

# BETA Protecting Miniature Circuit Breakers (MCBs)

Miniature circuit breakers,  
5SP and 5SY

10 000 3	$I_n$	MW	DT	Characteristic B			Characteristic C			PU	PS*	PG	Weight per PU approx. kg
				Order No.	Price per PU	PG DT	Order No.	Price per PU	PG				
<b>MCBs 10000 A, universal current</b>													
1P, 230/400 V AC, 220 V DC													
	0.3	1	--			C	<b>5SY5 114-7</b>		1	1	003	0.165	
	0.5		--			B	<b>5SY5 105-7</b>		1	1	003	0.165	
	1		--			A	<b>5SY5 101-7</b>		1	1	003	0.147	
	1.6		--			A	<b>5SY5 115-7</b>		1	1	003	0.165	
	2		--			A	<b>5SY5 102-7</b>		1	1	003	0.165	
	3		--		C	<b>5SY5 102-6</b>		002	1	1	003	0.165	
	4		--			A	<b>5SY5 103-7</b>		1	1	003	0.165	
	4		--		B	<b>5SY5 104-6</b>		002	1	1	003	0.165	
	6		--		A	<b>5SY5 106-6</b>		002	1	1	003	0.165	
	8		--			A	<b>5SY5 108-7</b>		1	1	003	0.165	
	10		--			A	<b>5SY5 110-6</b>		002	1	1	003	0.165
	13		--			C	<b>5SY5 113-6</b>		002	1	1	003	0.165
	16		--			A	<b>5SY5 116-6</b>		002	1	1	003	0.165
	20		--			C	<b>5SY5 120-6</b>		002	1	1	003	0.165
	25		--			C	<b>5SY5 125-6</b>		002	1	1	003	0.165
	32		--			C	<b>5SY5 132-6</b>		002	1	1	003	0.165
	40		--			C	<b>5SY5 140-6</b>		002	1	1	003	0.165
	50		--			C	<b>5SY5 150-6</b>		002	1	1	003	0.165
	63		--			C	<b>5SY5 163-6</b>		002	1	1	003	0.165
1P, 230/400 V AC, 220 V DC													
	80	1.5	--			B	<b>5SP5 180-7</b>		1	1	003	0.258	
	100		--			B	<b>5SP5 191-7</b>		1	1	003	0.258	
	125		--			B	<b>5SP5 192-7</b>		1	1	003	0.258	
2P, 400 V AC, 440 V DC													
	0.3	2	--			C	<b>5SY5 214-7</b>		1	1	003	0.330	
	0.5		--			B	<b>5SY5 205-7</b>		1	1	003	0.330	
	1		--			A	<b>5SY5 201-7</b>		1	1	003	0.330	
	1.6		--			B	<b>5SY5 215-7</b>		1	1	003	0.330	
	2		--			B	<b>5SY5 202-7</b>		1	1	003	0.330	
	3		--			B	<b>5SY5 203-7</b>		1	1	003	0.330	
	4		--			A	<b>5SY5 204-7</b>		1	1	003	0.330	
	6		--		A	<b>5SY5 206-6</b>		002	1	1/6	003	0.330	
	8		--			B	<b>5SY5 208-7</b>		1	1	003	0.330	
	10		--			A	<b>5SY5 210-6</b>		002	1	1	003	0.330
	13		--			C	<b>5SY5 213-6</b>		002	1	1	003	0.330
	16		--			A	<b>5SY5 216-6</b>		002	1	1	003	0.330
	20		--			A	<b>5SY5 220-6</b>		002	1	1	003	0.330
	25		--			C	<b>5SY5 225-6</b>		002	1	1	003	0.330
	32		--			B	<b>5SY5 232-6</b>		002	1	1	003	0.330
	40		--			C	<b>5SY5 240-6</b>		002	1	1	003	0.330
	50		--			C	<b>5SY5 250-6</b>		002	1	1	003	0.330
	63		--			C	<b>5SY5 263-6</b>		002	1	1	003	0.330
2P, 400 V AC, 440 V DC													
	80	3	--			B	<b>5SP5 280-7</b>		1	1	003	0.516	
	100		--			B	<b>5SP5 291-7</b>		1	1	003	0.516	
	125		--			B	<b>5SP5 292-7</b>		1	1	003	0.516	

\* You can order this quantity or a multiple thereof.

# BETA Protecting Miniature Circuit Breakers (MCBs)





## Miniature circuit breakers, 5SP and 5SY

10 000 3		$I_n$	MW	DT	Characteristic B			Characteristic C			PU	PS*	PG	Weight per PU approx. kg
					Order No.	Price per PU	PG	DT	Order No.	Price per PU				
		A												
 <p><b>MCBs 10000 A, universal current</b> 4P, 400 V AC, 880 V DC</p>		0.3	1	--			C	<b>5SY5 414-7</b>		1	1	003	0.660	
		0.5		--			C	<b>5SY5 405-7</b>		1	1	003	0.660	
		1		--			C	<b>5SY5 401-7</b>		1	1	003	0.660	
		1.6		--			C	<b>5SY5 415-7</b>		1	1	003	0.660	
		2		--			C	<b>5SY5 402-7</b>		1	1	003	0.660	
		3		--			C	<b>5SY5 403-7</b>		1	1	003	0.660	
		4		--			C	<b>5SY5 404-7</b>		1	1	003	0.660	
		6		C	<b>5SY5 406-6</b>		002	C	<b>5SY5 406-7</b>		1	1	003	0.660
		8		--			C	<b>5SY5 408-7</b>		1	1	003	0.660	
		10		C	<b>5SY5 410-6</b>		002	C	<b>5SY5 410-7</b>		1	1	003	0.660
		13		C	<b>5SY5 413-6</b>		002	C	<b>5SY5 413-7</b>		1	1	003	0.660
		16		C	<b>5SY5 416-6</b>		002	C	<b>5SY5 416-7</b>		1	1	003	0.660
		20		C	<b>5SY5 420-6</b>		002	C	<b>5SY5 420-7</b>		1	1	003	0.660
		25		C	<b>5SY5 425-6</b>		002	C	<b>5SY5 425-7</b>		1	1	003	0.660
		32		C	<b>5SY5 432-6</b>		002	C	<b>5SY5 432-7</b>		1	1	003	0.660
		40		C	<b>5SY5 440-6</b>		002	C	<b>5SY5 440-7</b>		1	1	003	0.660
50		C	<b>5SY5 450-6</b>		002	C	<b>5SY5 450-7</b>		1	1	003	0.660		
63		C	<b>5SY5 463-6</b>		002	C	<b>5SY5 463-7</b>		1	1	003	0.660		

\* You can order this quantity or a multiple thereof.

# BETA Protecting Miniature Circuit Breakers (MCBs)

Miniature circuit breakers,  
5SP and 5SY



15 000 3	$I_n$	MW	DT	Characteristic B		PU	PS*	PG	Weight per PU approx. kg
				Order No.	Price per PU				
<b>MCBs 15000 A</b>									
	1P, 230/400 V AC								
	6	1	▶	5SY7 106-6		1	1	002	0.165
	10		▶	5SY7 110-6		1	1	002	0.165
	13		C	5SY7 113-6		1	1	002	0.165
	16		▶	5SY7 116-6		1	1	002	0.165
	20		B	5SY7 120-6		1	1	002	0.165
	25		B	5SY7 125-6		1	1	002	0.165
	32		B	5SY7 132-6		1	1	002	0.165
	40		C	5SY7 140-6		1	1	002	0.165
	50		C	5SY7 150-6		1	1	002	0.165
63		C	5SY7 163-6		1	1	002	0.165	
	1P+N, 230 V AC								
	6	2	C	5SY7 506-6		1	1	002	0.330
	10		C	5SY7 510-6		1	1	002	0.330
	13		C	5SY7 513-6		1	1	002	0.330
	16		C	5SY7 516-6		1	1	002	0.330
	20		C	5SY7 520-6		1	1	002	0.330
	25		C	5SY7 525-6		1	1	002	0.330
	32		C	5SY7 532-6		1	1	002	0.330
	40		C	5SY7 540-6		1	1	002	0.330
	50		C	5SY7 550-6		1	1	002	0.330
63		C	5SY7 563-6		1	1	002	0.330	
	2P, 400 V AC								
	6	2	B	5SY7 206-6		1	1	002	0.330
	10		B	5SY7 210-6		1	1	002	0.330
	13		C	5SY7 213-6		1	1	002	0.330
	16		B	5SY7 216-6		1	1	002	0.330
	20		B	5SY7 220-6		1	1	002	0.330
	25		B	5SY7 225-6		1	1	002	0.330
	32		C	5SY7 232-6		1	1	002	0.330
	40		C	5SY7 240-6		1	1	002	0.330
	50		C	5SY7 250-6		1	1	002	0.330
63		C	5SY7 263-6		1	1	002	0.330	
	3P, 400 V AC								
	6	3	B	5SY7 306-6		1	1	002	0.495
	10		B	5SY7 310-6		1	1	002	0.495
	13		C	5SY7 313-6		1	1	002	0.495
	16		A	5SY7 316-6		1	1	002	0.495
	20		B	5SY7 320-6		1	1	002	0.495
	25		B	5SY7 325-6		1	1	002	0.495
	32		B	5SY7 332-6		1	1	002	0.495
	40		B	5SY7 340-6		1	1	002	0.495
	50		B	5SY7 350-6		1	1	002	0.495
63		C	5SY7 363-6		1	1	002	0.495	
	3P+N, 400 V AC								
	6	4	C	5SY7 606-6		1	1	002	0.660
	10		C	5SY7 610-6		1	1	002	0.660
	13		C	5SY7 613-6		1	1	002	0.660
	16		C	5SY7 616-6		1	1	002	0.660
	20		C	5SY7 620-6		1	1	002	0.660
	25		C	5SY7 625-6		1	1	002	0.660
	32		C	5SY7 632-6		1	1	002	0.660
	40		C	5SY7 640-6		1	1	002	0.660
	50		C	5SY7 650-6		1	1	002	0.660
63		C	5SY7 663-6		1	1	002	0.660	
	4P, 400 V AC								
	6	4	C	5SY7 406-6		1	1	002	0.660
	10		B	5SY7 410-6		1	1	002	0.660
	13		C	5SY7 413-6		1	1	002	0.660
	16		B	5SY7 416-6		1	1	002	0.660
	20		B	5SY7 420-6		1	1	002	0.660
	25		C	5SY7 425-6		1	1	002	0.660
	32		C	5SY7 432-6		1	1	002	0.660
	40		C	5SY7 440-6		1	1	002	0.660
	50		C	5SY7 450-6		1	1	002	0.660
63		C	5SY7 463-6		1	1	002	0.660	

\* You can order this quantity or a multiple thereof.



# BETA Protecting Miniature Circuit Breakers (MCBs)



Miniature circuit breakers,  
5SP and 5SY

15 000 3	$I_n$	MW	DT	Characteristic C			Characteristic D			PU	PS*	PG	Weight per PU approx. kg
				Order No.	Price per PU	PG DT	Order No.	Price per PU	Unit(s)				
<b>MCBs 15000 A</b>													
1P, 230/400 V AC													
	0.3	1	B	5SY7 114-7		003 C	5SY7 114-8		1	1	004	0.165	
	0.5		B	5SY7 105-7		003 C	5SY7 105-8		1	1	004	0.165	
	1		A	5SY7 101-7		003 C	5SY7 101-8		1	1	004	0.165	
	1.6		B	5SY7 115-7		003 C	5SY7 115-8		1	1	004	0.165	
	2		▶	5SY7 102-7		003 C	5SY7 102-8		1	1	004	0.165	
	3		A	5SY7 103-7		003 C	5SY7 103-8		1	1	004	0.165	
	4		A	5SY7 104-7		003 B	5SY7 104-8		1	1	004	0.165	
	6		▶	5SY7 106-7		003 B	5SY7 106-8		1	1	004	0.165	
	8		B	5SY7 108-7		003 C	5SY7 108-8		1	1	004	0.165	
	10		▶	5SY7 110-7		003 B	5SY7 110-8		1	1	004	0.165	
	13		B	5SY7 113-7		003 C	5SY7 113-8		1	1	004	0.165	
	16		▶	5SY7 116-7		003 B	5SY7 116-8		1	1	004	0.165	
	20		A	5SY7 120-7		003 C	5SY7 120-8		1	1	004	0.165	
	25		B	5SY7 125-7		003 C	5SY7 125-8		1	1	004	0.165	
	32		B	5SY7 132-7		003 C	5SY7 132-8		1	1	004	0.165	
	40		B	5SY7 140-7		003 C	5SY7 140-8		1	1	004	0.165	
	50		C	5SY7 150-7		003 C	5SY7 150-8		1	1	004	0.165	
	63		B	5SY7 163-7		003 C	5SY7 163-8		1	1	004	0.165	
1P+N, 230 V AC													
	0.3	2	C	5SY7 514-7		003 C	5SY7 514-8		1	1	004	0.330	
	0.5		C	5SY7 505-7		003 C	5SY7 505-8		1	1	004	0.330	
	1		B	5SY7 501-7		003 C	5SY7 501-8		1	1	004	0.330	
	1.6		C	5SY7 515-7		003 C	5SY7 515-8		1	1	004	0.330	
	2		B	5SY7 502-7		003 C	5SY7 502-8		1	1	004	0.330	
	3		B	5SY7 503-7		003 C	5SY7 503-8		1	1	004	0.330	
	4		B	5SY7 504-7		003 B	5SY7 504-8		1	1	004	0.330	
	6		A	5SY7 506-7		003 C	5SY7 506-8		1	1	004	0.330	
	8		C	5SY7 508-7		003 C	5SY7 508-8		1	1	004	0.330	
	10		A	5SY7 510-7		003 C	5SY7 510-8		1	1	004	0.330	
	13		B	5SY7 513-7		003 C	5SY7 513-8		1	1	004	0.330	
	16		A	5SY7 516-7		003 B	5SY7 516-8		1	1	004	0.330	
	20		B	5SY7 520-7		003 C	5SY7 520-8		1	1	004	0.330	
	25		B	5SY7 525-7		003 C	5SY7 525-8		1	1	004	0.330	
	32		B	5SY7 532-7		003 C	5SY7 532-8		1	1	004	0.330	
	40		C	5SY7 540-7		003 C	5SY7 540-8		1	1	004	0.330	
	50		C	5SY7 550-7		003 C	5SY7 550-8		1	1	004	0.330	
	63		C	5SY7 563-7		003 C	5SY7 563-8		1	1	004	0.330	
2P, 400 V AC													
	0.3	2	C	5SY7 214-7		003 C	5SY7 214-8		1	1	004	0.330	
	0.5		B	5SY7 205-7		003 C	5SY7 205-8		1	1	004	0.330	
	1		A	5SY7 201-7		003 B	5SY7 201-8		1	1	004	0.330	
	1.6		C	5SY7 215-7		003 C	5SY7 215-8		1	1	004	0.330	
	2		A	5SY7 202-7		003 A	5SY7 202-8		1	1	004	0.330	
	3		A	5SY7 203-7		003 B	5SY7 203-8		1	1	004	0.330	
	4		A	5SY7 204-7		003 A	5SY7 204-8		1	1	004	0.330	
	6		▶	5SY7 206-7		003 A	5SY7 206-8		1	1	004	0.330	
	8		B	5SY7 208-7		003 B	5SY7 208-8		1	1	004	0.330	
	10		▶	5SY7 210-7		003 A	5SY7 210-8		1	1	004	0.330	
	13		B	5SY7 213-7		003 C	5SY7 213-8		1	1	004	0.330	
	16		▶	5SY7 216-7		003 A	5SY7 216-8		1	1	004	0.330	
	20		A	5SY7 220-7		003 B	5SY7 220-8		1	1	004	0.330	
	25		A	5SY7 225-7		003 B	5SY7 225-8		1	1	004	0.330	
	32		A	5SY7 232-7		003 C	5SY7 232-8		1	1	004	0.330	
	40		A	5SY7 240-7		003 C	5SY7 240-8		1	1	004	0.330	
	50		B	5SY7 250-7		003 C	5SY7 250-8		1	1	004	0.330	
	63		B	5SY7 263-7		003 C	5SY7 263-8		1	1	004	0.330	

\* You can order this quantity or a multiple thereof.

# BETA Protecting Miniature Circuit Breakers (MCBs)

Miniature circuit breakers,  
5SP and 5SY

15 000 3	$I_n$	MW	DT	Characteristic C			Characteristic D			PU	PS*	PG	Weight per PU approx. kg
				Order No.	Price per PU	PG DT	Order No.	Price per PU	PG				
<b>MCBs 15000 A</b>													
3P, 400 V AC													
	0.3	3	C	5SY7 314-7		003 C	5SY7 314-8		1	1	004	0.495	
	0.5		C	5SY7 305-7		003 C	5SY7 305-8		1	1	004	0.495	
	1		C	5SY7 301-7		003 C	5SY7 301-8		1	1	004	0.495	
	1.6		C	5SY7 315-7		003 C	5SY7 315-8		1	1	004	0.495	
	2		B	5SY7 302-7		003 C	5SY7 302-8		1	1	004	0.495	
	3		C	5SY7 303-7		003 C	5SY7 303-8		1	1	004	0.495	
	4		A	5SY7 304-7		003 C	5SY7 304-8		1	1	004	0.495	
	6		A	5SY7 306-7		003 C	5SY7 306-8		1	1	004	0.495	
	8		C	5SY7 308-7		003 B	5SY7 308-8		1	1	004	0.495	
	10		A	5SY7 310-7		003 B	5SY7 310-8		1	1	004	0.495	
	13		B	5SY7 313-7		003 C	5SY7 313-8		1	1	004	0.495	
	16		▶	5SY7 316-7		003 A	5SY7 316-8		1	1	004	0.495	
	20		▶	5SY7 320-7		003 B	5SY7 320-8		1	1	004	0.495	
	25		▶	5SY7 325-7		003 A	5SY7 325-8		1	1	004	0.495	
	32		▶	5SY7 332-7		003 B	5SY7 332-8		1	1	004	0.495	
	40		▶	5SY7 340-7		003 B	5SY7 340-8		1	1	004	0.495	
	50		▶	5SY7 350-7		003 B	5SY7 350-8		1	1	004	0.495	
	63		▶	5SY7 363-7		003 B	5SY7 363-8		1	1	004	0.495	
3P+N, 400 V AC													
	0.3	4	C	5SY7 614-7		003 C	5SY7 614-8		1	1	004	0.660	
	0.5		C	5SY7 605-7		003 C	5SY7 605-8		1	1	004	0.660	
	1		C	5SY7 601-7		003 C	5SY7 601-8		1	1	004	0.660	
	1.6		C	5SY7 615-7		003 C	5SY7 615-8		1	1	004	0.660	
	2		C	5SY7 602-7		003 C	5SY7 602-8		1	1	004	0.660	
	3		C	5SY7 603-7		003 C	5SY7 603-8		1	1	004	0.660	
	4		C	5SY7 604-7		003 C	5SY7 604-8		1	1	004	0.660	
	6		C	5SY7 606-7		003 C	5SY7 606-8		1	1	004	0.660	
	8		C	5SY7 608-7		003 C	5SY7 608-8		1	1	004	0.660	
	10		B	5SY7 610-7		003 C	5SY7 610-8		1	1	004	0.660	
	13		C	5SY7 613-7		003 C	5SY7 613-8		1	1	004	0.660	
	16		A	5SY7 616-7		003 C	5SY7 616-8		1	1	004	0.660	
	20		B	5SY7 620-7		003 C	5SY7 620-8		1	1	004	0.660	
	25		B	5SY7 625-7		003 C	5SY7 625-8		1	1	004	0.660	
	32		B	5SY7 632-7		003 C	5SY7 632-8		1	1	004	0.660	
	40		B	5SY7 640-7		003 C	5SY7 640-8		1	1	004	0.660	
	50		B	5SY7 650-7		003 C	5SY7 650-8		1	1	004	0.660	
	63		B	5SY7 663-7		003 C	5SY7 663-8		1	1	004	0.660	
4P, 400 V AC													
	0.3	4	C	5SY7 414-7		003 C	5SY7 414-8		1	1	004	0.660	
	0.5		C	5SY7 405-7		003 C	5SY7 405-8		1	1	004	0.660	
	1		C	5SY7 401-7		003 C	5SY7 401-8		1	1	004	0.660	
	1.6		C	5SY7 415-7		003 C	5SY7 415-8		1	1	004	0.660	
	2		C	5SY7 402-7		003 C	5SY7 402-8		1	1	004	0.660	
	3		C	5SY7 403-7		003 C	5SY7 403-8		1	1	004	0.660	
	4		B	5SY7 404-7		003 C	5SY7 404-8		1	1	004	0.660	
	6		B	5SY7 406-7		003 C	5SY7 406-8		1	1	004	0.660	
	8		C	5SY7 408-7		003 C	5SY7 408-8		1	1	004	0.660	
	10		▶	5SY7 410-7		003 B	5SY7 410-8		1	1	004	0.660	
	13		C	5SY7 413-7		003 C	5SY7 413-8		1	1	004	0.660	
	16		▶	5SY7 416-7		003 B	5SY7 416-8		1	1	004	0.660	
	20		A	5SY7 420-7		003 B	5SY7 420-8		1	1	004	0.660	
	25		▶	5SY7 425-7		003 B	5SY7 425-8		1	1	004	0.660	
	32		▶	5SY7 432-7		003 B	5SY7 432-8		1	1	004	0.660	
	40		A	5SY7 440-7		003 B	5SY7 440-8		1	1	004	0.660	
	50		A	5SY7 450-7		003 B	5SY7 450-8		1	1	004	0.660	
	63		▶	5SY7 463-7		003 B	5SY7 463-8		1	1	004	0.660	

\* You can order this quantity or a multiple thereof.

# BETA Protecting Miniature Circuit Breakers (MCBs)



Miniature circuit breakers,  
5SP and 5SY

$I_n$	MW	DT	Characteristic C			Characteristic D			PU	PS*	PG	Weight per PU approx. kg
			Order No.	Price per PU	PG DT	Order No.	Price per PU	Unit(s)				
<b>MCBs 25 kA</b>												
1P, 230/400 V AC												
0.3	1	C	5SY8 114-7		003 C	5SY8 114-8		1	1	004	0.165	
0.5		C	5SY8 105-7		003 C	5SY8 105-8		1	1	004	0.165	
1		B	5SY8 101-7		003 C	5SY8 101-8		1	1	004	0.165	
1.6		C	5SY8 115-7		003 C	5SY8 115-8		1	1	004	0.165	
2		A	5SY8 102-7		003 B	5SY8 102-8		1	1	004	0.165	
3		C	5SY8 103-7		003 C	5SY8 103-8		1	1	004	0.165	
4		B	5SY8 104-7		003 C	5SY8 104-8		1	1	004	0.165	
6		A	5SY8 106-7		003 C	5SY8 106-8		1	1	004	0.165	
8		C	5SY8 108-7		003 C	5SY8 108-8		1	1	004	0.165	
10		A	5SY8 110-7		003 C	5SY8 110-8		1	1	004	0.165	
13		C	5SY8 113-7		003 C	5SY8 113-8		1	1	004	0.165	
16		A	5SY8 116-7		003 C	5SY8 116-8		1	1	004	0.165	
20		A	5SY8 120-7		003 C	5SY8 120-8		1	1	004	0.165	
25		C	5SY8 125-7		003 C	5SY8 125-8		1	1	004	0.165	
32		B	5SY8 132-7		003 C	5SY8 132-8		1	1	004	0.165	
40		C	5SY8 140-7		003 C	5SY8 140-8		1	1	004	0.165	
50		C	5SY8 150-7		003 C	5SY8 150-8		1	1	004	0.165	
63		C	5SY8 163-7		003 C	5SY8 163-8		1	1	004	0.165	
1P+N, 230 V AC												
0.3	2	C	5SY8 514-7		003 C	5SY8 514-8		1	1	004	0.330	
0.5		C	5SY8 505-7		003 C	5SY8 505-8		1	1	004	0.330	
1		C	5SY8 501-7		003 C	5SY8 501-8		1	1	004	0.330	
1.6		C	5SY8 515-7		003 C	5SY8 515-8		1	1	004	0.330	
2		C	5SY8 502-7		003 C	5SY8 502-8		1	1	004	0.330	
3		C	5SY8 503-7		003 C	5SY8 503-8		1	1	004	0.330	
4		C	5SY8 504-7		003 C	5SY8 504-8		1	1	004	0.330	
6		B	5SY8 506-7		003 C	5SY8 506-8		1	1	004	0.330	
8		C	5SY8 508-7		003 C	5SY8 508-8		1	1	004	0.330	
10		B	5SY8 510-7		003 C	5SY8 510-8		1	1	004	0.330	
13		C	5SY8 513-7		003 C	5SY8 513-8		1	1	004	0.330	
16		B	5SY8 516-7		003 C	5SY8 516-8		1	1	004	0.330	
20		C	5SY8 520-7		003 C	5SY8 520-8		1	1	004	0.330	
25		C	5SY8 525-7		003 C	5SY8 525-8		1	1	004	0.330	
32		B	5SY8 532-7		003 C	5SY8 532-8		1	1	004	0.330	
40		C	5SY8 540-7		003 B	5SY8 540-8		1	1	004	0.330	
50		B	5SY8 550-7		003 B	5SY8 550-8		1	1	004	0.330	
63		B	5SY8 563-7		003 B	5SY8 563-8		1	1	004	0.330	
2P, 400 V AC												
0.3	2	C	5SY8 214-7		003 C	5SY8 214-8		1	1	004	0.330	
0.5		C	5SY8 205-7		003 C	5SY8 205-8		1	1	004	0.330	
1		B	5SY8 201-7		003 C	5SY8 201-8		1	1	004	0.330	
1.6		C	5SY8 215-7		003 C	5SY8 215-8		1	1	004	0.330	
2		B	5SY8 202-7		003 B	5SY8 202-8		1	1	004	0.330	
3		C	5SY8 203-7		003 C	5SY8 203-8		1	1	004	0.330	
4		A	5SY8 204-7		003 C	5SY8 204-8		1	1	004	0.330	
6		A	5SY8 206-7		003 A	5SY8 206-8		1	1	004	0.330	
8		C	5SY8 208-7		003 C	5SY8 208-8		1	1	004	0.330	
10		A	5SY8 210-7		003 B	5SY8 210-8		1	1	004	0.330	
13		C	5SY8 213-7		003 C	5SY8 213-8		1	1	004	0.330	
16		A	5SY8 216-7		003 C	5SY8 216-8		1	1	004	0.330	
20		B	5SY8 220-7		003 C	5SY8 220-8		1	1	004	0.330	
25		B	5SY8 225-7		003 B	5SY8 225-8		1	1	004	0.330	
32		B	5SY8 232-7		003 C	5SY8 232-8		1	1	004	0.330	
40		C	5SY8 240-7		003 C	5SY8 240-8		1	1	004	0.330	
50		C	5SY8 250-7		003 C	5SY8 250-8		1	1	004	0.330	
63		C	5SY8 263-7		003 C	5SY8 263-8		1	1	004	0.330	

\* You can order this quantity or a multiple thereof.

# BETA Protecting Miniature Circuit Breakers (MCBs)

Miniature circuit breakers,  
5SP and 5SY

$I_n$	MW	DT	Characteristic C			Characteristic D			PU	PS*	PG	Weight per PU approx. kg
			Order No.	Price per PU	PG DT	Order No.	Price per PU	Unit(s)				
<b>MCBs 25 kA</b>												
3P, 400 V AC												
	0.3	3	C	5SY8 314-7		003 C	5SY8 314-8		1	1	004	0.495
	0.5		C	5SY8 305-7		003 C	5SY8 305-8		1	1	004	0.495
	1		A	5SY8 301-7		003 C	5SY8 301-8		1	1	004	0.495
	1.6		C	5SY8 315-7		003 C	5SY8 315-8		1	1	004	0.495
	2		C	5SY8 302-7		003 C	5SY8 302-8		1	1	004	0.495
	3		C	5SY8 303-7		003 C	5SY8 303-8		1	1	004	0.495
	4		C	5SY8 304-7		003 C	5SY8 304-8		1	1	004	0.495
	6		B	5SY8 306-7		003 C	5SY8 306-8		1	1	004	0.495
	8		C	5SY8 308-7		003 C	5SY8 308-8		1	1	004	0.495
	10		B	5SY8 310-7		003 C	5SY8 310-8		1	1	004	0.495
	13		C	5SY8 313-7		003 C	5SY8 313-8		1	1	004	0.495
	16		A	5SY8 316-7		003 C	5SY8 316-8		1	1	004	0.495
	20		C	5SY8 320-7		003 C	5SY8 320-8		1	1	004	0.495
	25		A	5SY8 325-7		003 B	5SY8 325-8		1	1	004	0.495
	32		A	5SY8 332-7		003 B	5SY8 332-8		1	1	004	0.495
	40		B	5SY8 340-7		003 C	5SY8 340-8		1	1	004	0.495
	50		B	5SY8 350-7		003 B	5SY8 350-8		1	1	004	0.495
	63		B	5SY8 363-7		003 C	5SY8 363-8		1	1	004	0.495
3P+N, 400 V AC												
	0.3	4	C	5SY8 614-7		003 C	5SY8 614-8		1	1	004	0.660
	0.5		C	5SY8 605-7		003 C	5SY8 605-8		1	1	004	0.660
	1		C	5SY8 601-7		003 C	5SY8 601-8		1	1	004	0.660
	1.6		C	5SY8 615-7		003 C	5SY8 615-8		1	1	004	0.660
	2		C	5SY8 602-7		003 C	5SY8 602-8		1	1	004	0.660
	3		C	5SY8 603-7		003 C	5SY8 603-8		1	1	004	0.660
	4		C	5SY8 604-7		003 C	5SY8 604-8		1	1	004	0.660
	6		C	5SY8 606-7		003 C	5SY8 606-8		1	1	004	0.660
	8		C	5SY8 608-7		003 C	5SY8 608-8		1	1	004	0.660
	10		C	5SY8 610-7		003 C	5SY8 610-8		1	1	004	0.660
	13		C	5SY8 613-7		003 C	5SY8 613-8		1	1	004	0.660
	16		B	5SY8 616-7		003 C	5SY8 616-8		1	1	004	0.660
	20		C	5SY8 620-7		003 C	5SY8 620-8		1	1	004	0.660
	25		C	5SY8 625-7		003 C	5SY8 625-8		1	1	004	0.660
	32		B	5SY8 632-7		003 C	5SY8 632-8		1	1	004	0.660
	40		C	5SY8 640-7		003 C	5SY8 640-8		1	1	004	0.660
	50		C	5SY8 650-7		003 C	5SY8 650-8		1	1	004	0.660
	63		A	5SY8 663-7		003 C	5SY8 663-8		1	1	004	0.660
4P, 400 V AC												
	0.3	4	C	5SY8 414-7		003 C	5SY8 414-8		1	1	004	0.660
	0.5		C	5SY8 405-7		003 C	5SY8 405-8		1	1	004	0.660
	1		C	5SY8 401-7		003 C	5SY8 401-8		1	1	004	0.660
	1.6		C	5SY8 415-7		003 C	5SY8 415-8		1	1	004	0.660
	2		C	5SY8 402-7		003 C	5SY8 402-8		1	1	004	0.660
	3		C	5SY8 403-7		003 C	5SY8 403-8		1	1	004	0.660
	4		C	5SY8 404-7		003 C	5SY8 404-8		1	1	004	0.660
	6		C	5SY8 406-7		003 C	5SY8 406-8		1	1	004	0.660
	8		C	5SY8 408-7		003 C	5SY8 408-8		1	1	004	0.660
	10		B	5SY8 410-7		003 C	5SY8 410-8		1	1	004	0.660
	13		C	5SY8 413-7		003 C	5SY8 413-8		1	1	004	0.660
	16		A	5SY8 416-7		003 C	5SY8 416-8		1	1	004	0.660
	20		A	5SY8 420-7		003 C	5SY8 420-8		1	1	004	0.660
	25		A	5SY8 425-7		003 C	5SY8 425-8		1	1	004	0.660
	32		A	5SY8 432-7		003 C	5SY8 432-8		1	1	004	0.660
	40		A	5SY8 440-7		003 C	5SY8 440-8		1	1	004	0.660
	50		A	5SY8 450-7		003 C	5SY8 450-8		1	1	004	0.660
	63		A	5SY8 463-7		003 C	5SY8 463-8		1	1	004	0.660

\* You can order this quantity or a multiple thereof.

# BETA Protecting Miniature Circuit Breakers (MCBs)

Miniature circuit breakers with plug-in terminal,  
5SJ6...-KS

## Overview

Miniature circuit breakers with plug-in terminals are used for the protection of socket outlets and lighting circuits with the most common rated currents of 10 to 20 A.

## Benefits

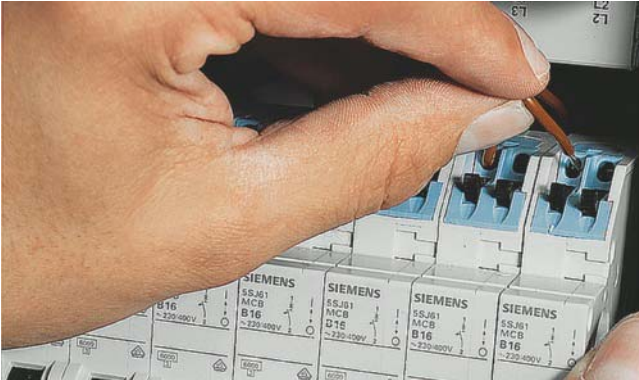

- Double, screwless independent outgoing terminals for fast connection of conductors.



- The plug-in terminals offer angled, easily accessible cable entries for manual insertion, which saves mounting time
- Separate removal of individual conductors requires no tools and provides a high level of operational reliability.
- No end sleeves required for finely stranded conductors. This saves mounting time.

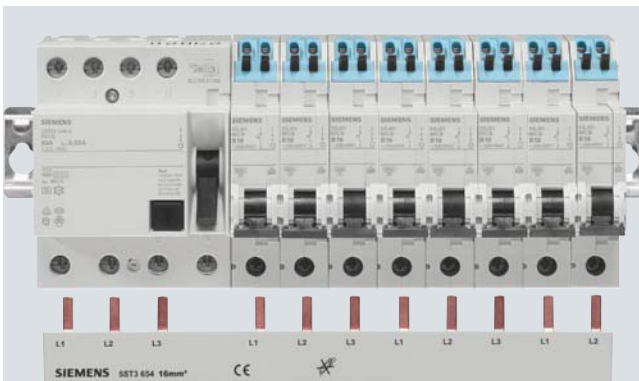





- Conventional pin busbars are used for the incoming terminal. This ensures clear, manageable and convenient access to all connections within the framework of the Siemens connection concept.

# BETA Protecting Miniature Circuit Breakers (MCBs)

Miniature circuit breakers with plug-in terminal,  
5SJ6...-KS

## Selection and ordering data

6 000 3		$I_n$	MW	DT	Characteristic B		Characteristic C		PU	PS*	PG	Weight per PU approx.		
		A			Order No.	Price per PU	PG	DT	Order No.	Price per PU	PU	PS*	PG	Weight per PU approx.
											Unit(s)	Unit(s)		kg
<b>MCBs with plug-in terminals</b>														
<b>1P</b>														
		10	1	B	<b>5SJ6 110-6KS</b>		002	B	<b>5SJ6 110-7KS</b>		1	1	003	0.111
		13		B	<b>5SJ6 113-6KS</b>		002	B	<b>5SJ6 113-7KS</b>		1	1/12	003	0.111
		16		A	<b>5SJ6 116-6KS</b>		002	B	<b>5SJ6 116-7KS</b>		1	1	003	0.111
		20		B	<b>5SJ6 120-6KS</b>		002	B	<b>5SJ6 120-7KS</b>		1	1/12	003	0.111
<b>1P+N</b>														
		10	2	B	<b>5SJ6 510-6KS</b>		002	B	<b>5SJ6 510-7KS</b>		1	1/6	003	0.185
		13		B	<b>5SJ6 513-6KS</b>		002	B	<b>5SJ6 513-7KS</b>		1	1/6	003	0.185
		16		B	<b>5SJ6 516-6KS</b>		002	B	<b>5SJ6 516-7KS</b>		1	1/6	003	0.185
		20		B	<b>5SJ6 520-6KS</b>		002	B	<b>5SJ6 520-7KS</b>		1	1/6	003	0.185
<b>2P</b>														
		10	2	B	<b>5SJ6 210-6KS</b>		002	B	<b>5SJ6 210-7KS</b>		1	1/6	003	0.225
		13		B	<b>5SJ6 213-6KS</b>		002	B	<b>5SJ6 213-7KS</b>		1	1/6	003	0.225
		16		B	<b>5SJ6 216-6KS</b>		002	B	<b>5SJ6 216-7KS</b>		1	1/6	003	0.225
		20		B	<b>5SJ6 220-6KS</b>		002	B	<b>5SJ6 220-7KS</b>		1	1/6	003	0.225
<b>3P</b>														
		10	3	B	<b>5SJ6 310-6KS</b>		002	B	<b>5SJ6 310-7KS</b>		1	1/4	003	0.345
		13		B	<b>5SJ6 313-6KS</b>		002	B	<b>5SJ6 313-7KS</b>		1	1/4	003	0.345
		16		B	<b>5SJ6 316-6KS</b>		002	B	<b>5SJ6 316-7KS</b>		1	1/4	003	0.345
		20		B	<b>5SJ6 320-6KS</b>		002	B	<b>5SJ6 320-7KS</b>		1	1/4	003	0.345

\* You can order this quantity or a multiple thereof.

# BETA Protecting Miniature Circuit Breakers (MCBs)

Miniature circuit breakers 1 + N in 1 MW,  
5SY6 0

## Overview

These miniature circuit breakers are used for the protection of plants with switched neutral conductors in distribution boards with little space. They are only a single modular width.

Compact busbars facilitate installation in space saving distribution boards.

The devices are approved for worldwide use according to IEC standards for systems up to 250 V AC. 60 V DC per pole is permitted in DC systems according to IEC standards.

## Benefits



- Auxiliary switches and fault signal contacts from the high-capacity range can be freely mounted on these miniature circuit breakers. This increases availability and cuts down on logistics.



- For 3-pole busbars, the 5ST3 6 busbar system is used – a universal system, suitable for all miniature circuit breakers.



- By actuating the latching slide, the miniature circuit breakers can be quickly and easily removed from the assembly.









- The infeed can be implemented either from the top or the bottom. Additional terminals with lateral insertion of conductors facilitate mounting when using large conductor cross-sections.

# BETA Protecting Miniature Circuit Breakers (MCBs)

Miniature circuit breakers 1 + N in 1 MW, 5SY6 0

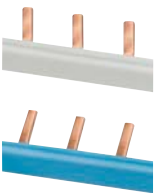
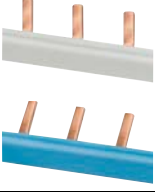
## Selection and ordering data

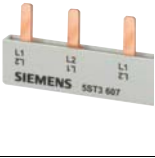
6 000 3		$I_n$	MW	DT	Characteristic B			Characteristic C			Weight per PU approx. kg			
		A			Order No.	Price per PU	PG	DT	Order No.	Price per PU		PU	PS*	PG
Miniature circuit breakers 1+N (1P+N), 230 V AC														
N pole right														
	2	1	--				A		5SY6 002-7		1	1	003	0.107
	4		--				A		5SY6 004-7		1	1	003	0.106
	6		5SY6 006-6				002	A	5SY6 006-7		1	1	003	0.100
	8		--				D		5SY6 008-7		1	1	003	0.100
	10		5SY6 010-6				002	A	5SY6 010-7		1	1	003	0.100
	13		5SY6 013-6				002	A	5SY6 013-7		1	1	003	0.100
	16		5SY6 016-6				002	A	5SY6 016-7		1	1	003	0.100
	20		5SY6 020-6				002	A	5SY6 020-7		1	1	003	0.100
	25		5SY6 025-6				002	A	5SY6 025-7		1	1	003	0.100
	32		5SY6 032-6				002	A	5SY6 032-7		1	1	003	0.100
40		5SY6 040-6				002	D	5SY6 040-7		1	1	003	0.100	
N pole left														
	2	1	--				A		5SY6 002-7KL		1	1	003	0.100
	4		--				A		5SY6 004-7KL		1	1	003	0.100
	6		5SY6 006-6KL				002	D	5SY6 006-7KL		1	1	003	0.100
	8		--				D		5SY6 008-7KL		1	1	003	0.100
	10		5SY6 010-6KL				002	A	5SY6 010-7KL		1	1	003	0.100
	13		5SY6 013-6KL				002	D	5SY6 013-7KL		1	1	003	0.100
	16		5SY6 016-6KL				002	D	5SY6 016-7KL		1	1	003	0.100
	20		5SY6 020-6KL				002	D	5SY6 020-7KL		1	1	003	0.100
	25		5SY6 025-6KL				002	D	5SY6 025-7KL		1	1	003	0.100
	32		5SY6 032-6KL				002	D	5SY6 032-7KL		1	1	003	0.100
40		5SY6 040-6KL				002	D	5SY6 040-7KL		1	1	003	0.100	

		Pin spacing	Length	DT	Order No.	Price per PU	PU	PS*	PG	Weight per PU approx. kg
		MW	mm				Unit(s)	Unit(s)		
	<b>5ST3 7 busbar system, 10 mm<sup>2</sup>, 12 MW, for MCBs 1+N in 1 MW of the compact range, can be cut, with end caps</b>									
	Single-phase									
	For 12 MCB 1+N, gray	1	216	A	5ST3 762		1	10	027	0.029
	For 12 MCB 1+N, blue		216	A	5ST3 763		1	10	027	0.029
	<b>5ST3 7 busbar system, 10 mm<sup>2</sup>, for MCBs 1+N in 1 MW of the compact range, can be cut, without end caps</b>									
	Single-phase									
	For MCBs 1+N, gray	1	1016	A	5ST3 764		1	10	027	0.134
	For MCBs 1+N, blue		1016	A	5ST3 765		1	10	027	0.134
	<b>End caps for 5ST3 76 busbars</b>									
	1 set comprises a right and a left cap									
	Gray			A	5ST3 766		1 set	10 sets	027	
	Blue			A	5ST3 767		1 set	10 sets	027	
	<b>5ST3 6 busbar system, 10 mm<sup>2</sup>, for MCBs, fixed lengths, cannot be cut, fully insulated</b>									
	Three-phase									
	For 2 MCB 3P	1	102	A	5ST3 613		1	10	027	0.039
	For 3 MCB 3P		257.5	A	5ST3 614		1	10	027	0.060
	For 4 MCB 3P		210	▶	5ST3 615		1	10	027	0.076
	<b>Terminals for 5ST3 76</b>									
	Side terminals			A	5ST3 768		1	25	027	0.011
	For conductors up to 25 mm <sup>2</sup>									

\* You can order this quantity or a multiple thereof.



# BETA Protecting Miniature Circuit Breakers (MCBs)

## Additional components

### Overview

This mounting concept enables all additional 5ST3 components to be combined with Siemens miniature circuit breakers as well as with 5SU1 RCBOs.

#### Auxiliary contacts

The auxiliary switch (AS) signals the contact position of the miniature circuit breaker regardless of whether the miniature circuit breaker was tripped by hand or by a fault. An additional version for the switching of small currents and small voltages for the control of programmable control systems (PLCs) according to EN 61131-2 is available. The version "auxiliary switch with test button" enables the testing of auxiliary contacts without the need to switch the miniature circuit breaker.

The fault signal contact (FC) signals the automatic tripping of the miniature circuit breaker in the event of a fault, e. g. due to an overload or a short circuit. The contact position does not change when the miniature circuit breaker is tripped by hand.

#### Test and reset button

The version "fault signal contact with test and reset button" enables the testing of auxiliary contacts without the need to switch the miniature circuit breaker. With this version, if the miniature circuit breaker is automatically tripped in the event of a fault, this also automatically trips the RESET button integrated in the handle of the fault signal contact. After the miniature circuit breaker has been tripped, the reset button can be manually acknowledged, which deletes the pending fault signal.

#### Auxiliary releases

Undervoltage releases are integrated e. g. in an EMERGENCY-STOP loop, thus ensuring that the miniature circuit breaker trips in the event of an emergency, which in turn ensures disconnection of the control circuit according to EN 60204. In the event that the voltage is interrupted or too low, it also trips, i. e. prevents the miniature circuit breaker from switching on.

Shunt trips are used for the remote tripping of miniature circuit breakers. Remote-controlled mechanisms are used for the remote switching (ON/OFF) of miniature circuit breakers and the remote switching (ON) of RC units.

#### Remote control

Remote-controlled mechanisms also enable local manual switching. A blocking function permits maintenance work. In the event that a miniature circuit breaker or RC unit is tripped, an acknowledgment must be carried out prior to switching back on. The remote-controlled mechanism has an operating mode selector switch with the functions: "Locked", "Manual" and "Remote Switching". The mechanism can be mechanically latched and locked, which serves to protect personnel during maintenance work.

#### RC units

RC units are combined with miniature circuit breakers of A, B, C and D characteristics. They then form a combination of RCCB and MCB for personnel, fire and line protection. The combinations can be individually assembled to suit the requirement.

For information on RC units, please refer to the section "Residual current protective devices".

### Benefits

- Universal mountability of all additional components



- The 5SY and 5SP miniature circuit breakers are ideal for the quick and easy mounting of auxiliary switches and fault signal contacts. Captive metal brackets on additional components ensure the quick and easy mounting of devices on the miniature circuit breakers without the need for tools.



- The auxiliary switches with test button enable easy testing of the control circuits by hand during operation of the complete system without the need to switch the miniature circuit breaker.



- Fault signal contacts with test and reset button enable the simple testing of auxiliary circuits and, in the event of a fault, acknowledgement of the fault over the reset button, without the need to switch the miniature circuit breakers.
- Auxiliary switches for small outputs enable their use with PLCs.
- Bus systems, such as *instabus* KNX, AS-Interface bus or PROFIBUS, are integrated in the communication over binary inputs and actuators.

#### Auxiliary switches (AS)

- Huge range of applications, thanks to additional versions for the switching of small currents and voltages for the control of programmable control systems (PLCs) according to EN 61131-2.









#### Remote-controlled mechanisms (RC)

- The remote-controlled mechanism has an operating mode selector switch with the functions: "Locked", "Manual" and "Remote switching". The mechanism can be mechanically latched and locked, which serves to protect personnel during maintenance work.

# BETA Protecting Miniature Circuit Breakers (MCBs)

## Additional components





### Selection and ordering data

	MW	DT	Order No.	Price per PU	PU	PS*	PG	Weight per PU approx.	
					Unit(s)	Unit(s)		kg	
	<b>Auxiliary switches (AS)</b>								
	For 5SY, 5SP miniature circuit breakers, 5SU1 RCBOs and 5TE8 switches								
	1 NO + 1 NC	0.5	▶	<b>5ST3 010</b>		1	1	027	0.050
	• for low loading		▶	<b>5ST3 013</b>		1	1	027	0.050
	2 NO		A	<b>5ST3 011</b>		1	1	027	0.050
	• for low loading		B	<b>5ST3 014</b>		1	1	027	0.050
2 NC		A	<b>5ST3 012</b>		1	1	027	0.050	
• for low loading		B	<b>5ST3 015</b>		1	1	027	0.050	
	<b>Auxiliary switches (AS) with test button</b>								
	For 5SY, 5SP miniature circuit breakers, 5SU1 RCBOs and 5TE8 switches								
	1 NO + 1 NC	0.5	A	<b>5ST3 010-2</b>		1	1	027	0.045
	• for low loading		A	<b>5ST3 013-2</b>		1	1	027	0.045
	2 NO		A	<b>5ST3 011-2</b>		1	1	027	0.045
	• for low loading		A	<b>5ST3 014-2</b>		1	1	027	0.045
2 NC		A	<b>5ST3 012-2</b>		1	1	027	0.045	
• for low loading		A	<b>5ST3 015-2</b>		1	1	027	0.045	
	<b>Fault signal contacts (FC)</b>								
	For 5SY, 5SP miniature circuit breakers and 5SU1 RCBOs								
	1 NO + 1 NC	0.5	▶	<b>5ST3 020</b>		1	1	027	0.050
	2 NO		B	<b>5ST3 021</b>		1	1	027	0.050
2 NC		A	<b>5ST3 022</b>		1	1	027	0.050	
	<b>Fault signal contacts (FC) with test and acknowledgement button</b>								
	For 5SY, 5SP miniature circuit breakers and 5SU1 RCBOs								
	1 NO + 1 NC	0.5	A	<b>5ST3 020-2</b>		1	1	027	0.050
	2 NO		A	<b>5ST3 021-2</b>		1	1	027	0.050
2 NC		A	<b>5ST3 022-2</b>		1	1	027	0.050	
	<b>Undervoltage releases (UR)</b>								
	For 5SY, 5SP miniature circuit breakers and 5SU1 RCBOs but not for 5SY6 0..								
	With integrated auxiliary switch								
	230 AC	1	A	<b>5ST3 040</b>		1	1	027	0.115
	110 DC		B	<b>5ST3 041</b>		1	1	027	0.115
	24 DC		B	<b>5ST3 042</b>		1	1	027	0.115
	Without integrated auxiliary switch								
	230 AC	1	A	<b>5ST3 043</b>		1	1	027	0.115
110 DC		B	<b>5ST3 044</b>		1	1	027	0.115	
24 DC		A	<b>5ST3 045</b>		1	1	027	0.115	
	<b>Shunt trips (ST)</b>								
	For 5SY, 5SP miniature circuit breakers and 5SU1 RCBOs but not for 5SY6 0..								
	2 NO	1	▶	<b>5ST3 030</b>		1	1	027	0.098
2 NC	1	▶	<b>5ST3 031</b>		1	1	027	0.098	
	<b>Remote-controlled mechanisms (RC)</b>								
	For 5SY, 5SP4 miniature circuit breakers and 5SU1 RCBOs								
230 AC	3.5	A	<b>5ST3 050</b>		1	1	027	0.395	
	<b>Handle couplers for additional components</b>								
	For mounting the additional components: auxiliary switches, fault signal contacts, shunt trips and undervoltage releases onto 5SU1 RCBOs, you require a handle coupler (1 set = 5 units).								
		▶	<b>5ST3 805-1</b>		1 set	1 set	027	0.008	

\* You can order this quantity or a multiple thereof.

# BETA Protecting Miniature Circuit Breakers (MCBs)







## Additional components

	Rated residual current	Rated current	MW	DT	Order No.	Price per PU	PU	PS*	PG	Weight per PU approx.
	$I_{\Delta n}$ mA	$I_n$ A					Unit(s)	Unit(s)		kg
<b>RC units, type A, instantaneous tripping</b>										
For 5SY miniature circuit breakers but not for 5SY5 and 5SY6 0..										
2P, 230 ... 400 V AC, 50 ... 60 Hz										
	10	0.3 ... 16	2	B	<b>5SM2 121-6</b>		1	1	007	0.180
	30	0.3 ... 40		▶	<b>5SM2 322-6</b>		1	1	007	0.170
	300			A	<b>5SM2 622-6</b>		1	1	007	0.170
	30	0.3 ... 63		A	<b>5SM2 325-6</b>		1	1	007	0.170
	100			B	<b>5SM2 425-6</b>		1	1	007	0.170
	300			B	<b>5SM2 625-6</b>		1	1	007	0.170
500			B	<b>5SM2 725-6</b>		1	1	007	0.170	
3P, 230 ... 400 V AC, 50 ... 60 Hz										
	30	0.3 ... 40	3	A	<b>5SM2 332-6</b>		1	1	007	0.260
	300			A	<b>5SM2 632-6</b>		1	1	007	0.260
	30	0.3 ... 63		B	<b>5SM2 335-6</b>		1	1	007	0.260
	100			B	<b>5SM2 435-6</b>		1	1	007	0.260
	300			B	<b>5SM2 635-6</b>		1	1	007	0.260
	500			B	<b>5SM2 735-6</b>		1	1	007	0.260
4P, 230 ... 400 V AC, 50 ... 60 Hz										
	30	0.3 ... 40	3	▶	<b>5SM2 342-6</b>		1	1	007	0.290
	300			▶	<b>5SM2 642-6</b>		1	1	007	0.290
	30	0.3 ... 63		A	<b>5SM2 345-6</b>		1	1	007	0.290
	100			B	<b>5SM2 445-6</b>		1	1	007	0.290
	300			A	<b>5SM2 645-6</b>		1	1	007	0.290
	500			A	<b>5SM2 745-6</b>		1	1	007	0.290
for 5SP4 miniature circuit breakers										
2P, 125 ... 230 V AC, 50 ... 60 Hz										
	30	80 ... 100	3.5	B	<b>5SM2 327-6</b>		1	1	007	0.410
	300			B	<b>5SM2 627-6</b>		1	1	007	0.410
4P, 230 ... 400 V AC, 50 ... 60 Hz										
	30	80 ... 100	5	B	<b>5SM2 347-6</b>		1	1	007	0.630
	300			A	<b>5SM2 647-6</b>		1	1	007	0.630

\* You can order this quantity or a multiple thereof.

# BETA Protecting Miniature Circuit Breakers (MCBs)

## Additional components

	Rated residual current $I_{\Delta n}$ mA	Rated current $I_n$ A	MW	DT	Order No.	Price per PU	PU Unit(s)	PS* Unit(s)	PG	Weight per PU approx. kg
<b>RC units, type A, super resistant </b>										
For 5SY miniature circuit breakers but not for 5SY5 and 5SY6 0..										
2P, 230 ... 400 V AC, 50 ... 60 Hz										
	30	0.3 ... 40	2	B	<b>5SM2 322-6KK01</b>		1	1	007	0.350
	30	0.3 ... 63		B	<b>5SM2 325-6KK01</b>		1	1	007	0.350
3P, 230 ... 400 V AC, 50 ... 60 Hz										
	30	0.3 ... 40	3	B	<b>5SM2 332-6KK01</b>		1	1	007	0.365
	30	0.3 ... 63		B	<b>5SM2 335-6KK01</b>		1	1	007	0.365
4P, 230 ... 400 V AC, 50 ... 60 Hz										
	30	0.3 ... 40	3	B	<b>5SM2 342-6KK01</b>		1	1	007	0.290
	30	0.3 ... 63		B	<b>5SM2 345-6KK01</b>		1	1	007	0.290
<b>RC units, type A, selective </b>										
For 5SY miniature circuit breakers but not for 5SY5 and 5SY6 0..										
2P, 230 ... 400 V AC, 50 ... 60 Hz										
	300	0.3 ... 40	2	A	<b>5SM2 622-8</b>		1	1	007	0.170
	300	0.3 ... 63		B	<b>5SM2 625-8</b>		1	1	007	0.170
3P, 230 ... 400 V AC, 50 ... 60 Hz										
	300	0.3 ... 63	3	B	<b>5SM2 635-8</b>		1	1	007	0.260
	500			B	<b>5SM2 735-8</b>		1	1	007	0.400
	1000			B	<b>5SM2 835-8</b>		1	1	007	0.260
4P, 230 ... 400 V AC, 50 ... 60 Hz										
	300	0.3 ... 63	3	A	<b>5SM2 645-8</b>		1	1	007	0.290
	500			A	<b>5SM2 745-8</b>		1	1	007	0.400
	1000			A	<b>5SM2 845-8</b>		1	1	007	0.290
for 5SP4 miniature circuit breakers										
2P; 125 ... 230 V AC, 50 ... 60 Hz										
	300	80 ... 100	3.5	B	<b>5SM2 627-8</b>		1	1	007	0.410
4P; 230 ... 400 V AC, 50 ... 60 Hz										
	300	80 ... 100	5	A	<b>5SM2 647-8</b>		1	1	007	0.630
	1000			A	<b>5SM2 847-8</b>		1	1	007	0.630

\* You can order this quantity or a multiple thereof.

# BETA Protecting Miniature Circuit Breakers (MCBs)

## Additional components

Version	MW	DT	Order No.	Price per PU	PU	PS*	PG	Weight per PU approx.
					Unit(s)	Unit(s)		kg
<b>Terminal covers</b>								
		B	<b>5ST3 800</b>		1	10	027	0.001
For miniature circuit breakers for additional covering of the screw openings per pole, sealable. On 5SY prevents the device also being removed from the standard mounting rail.								
<b>Handle locking devices</b>								
		A	<b>5ST3 801</b>		1	1	027	0.008
Prevents inadvertent manual on and off switching, sealable For 5SP and 5SY miniature circuit breakers For padlock with max. 3 mm shackle								
		A	<b>5ST3 806</b>		1	5	027	0.007
For 5SJ, 5SP and 5SY miniature circuit breakers For padlock with max. 3 ... 6 mm shackle								
<b>Padlocks</b>								
			<b>5ST3 802</b>		1	1	027	0.027
For 5ST3 801 and 5ST3 806 handle locking device ▶								
<b>Locking devices</b>								
		B	<b>5ST3 803</b>		1 set	1 set	027	0.035
Consisting of 5ST3 801 handle locking device and 5ST3 802 padlock								
<b>Spacers</b>								
	0.5	▶	<b>5TG8 240</b>		1	2	027	0.010
Can be placed on either side of the standard mounting rail, so that two spacers allow for convenient cable routing								
<b>Fixing parts</b>								
		B	<b>5ST2 201</b>		1	1	027	0.012
Made of plastic, for use with a mounting plate								
<b>Inscription labels</b>								
		B	<b>5ST2 173</b>		1 set	1 set	027	0.038
15 mm × 9 mm, 3 frames à 44 labels, can be mounted on casing collar, white, self-adhesive								

### Labeling systems

Inscriptions on self-adhesive labels for a neat and uniform appearance in the power distribution system. The labeling program can be downloaded to your PC free of charge:





[www.siemens.com/labeling-tool](http://www.siemens.com/labeling-tool)

Recommended ELAT-3-747 labels for printing out on standard printers can be ordered at BRADY:

[www.bradycorp.com](http://www.bradycorp.com)

# BETA Protecting Miniature Circuit Breakers (MCBs)

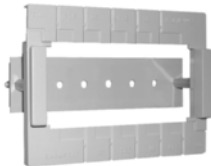
## Additional components

	Version	DT	Order No.	Price per PU	PU	PS*	PG	Weight per PU approx. kg
					Unit(s)	Unit(s)		
	<b>Terminal covers, gray</b> For surface mounting, degree of protection IP40, sealable, with TH 35 standard mounting rail <ul style="list-style-type: none"><li>• Up to 2.5 MW</li><li>• Up to 4.5 MW</li></ul>	B	<b>5SW3 004</b>		1	1	008	0.084
		B	<b>5SW3 005</b>		1	1	008	0.114
	<b>Wall enclosures, gray</b> For flush mounting, degree of protection IP40, with TH 35 standard mounting rail <ul style="list-style-type: none"><li>• Up to 2.5 MW</li><li>• Up to 4.5 MW</li></ul>	B	<b>5SW3 006</b>		1	1/4	008	0.126
		B	<b>5SW3 007</b>		1	1	008	0.147
	<b>Molded-plastic enclosures, gray</b> For surface mounting, degree of protection IP54, sealable, with transparent hinged lid, with TH 35 standard mounting rail For 4.5 MW	A	<b>5SW1 200</b>		1	1	008	0.450
	<b>Covers</b> Can be assembled as mini distribution board, suitable for all devices, cover parts prepared for rail mounting of conventional label caps, comprising: <ul style="list-style-type: none"><li>• End plates (can be snapped onto TH 35 standard mounting rail)</li><li>• Angle section (approx. 1 m long)</li><li>• Alternatively flat profile (as a cover between the rows of devices length approx. 1 m)</li></ul>	A	<b>5ST2 134</b>		1	10	027	0.022
		A	<b>5ST2 135</b>		1	5	027	0.330
		B	<b>5ST2 136</b>		1	5	027	0.260
	<b>Holder for installation in front panels</b> Universal application for devices from 1 MW to 6 MW Cutout dimensions: Height 45 <sup>+0.5</sup> mm Width 23, 41, 59, 77, 95 or 113 mm	B	<b>7LF9 006</b>		1	1	025	0.071
	<b>Intermediate frame for 70 mm devices in N distribution boards</b> Versions <ul style="list-style-type: none"><li>• 1 row</li><li>• 2 rows</li><li>• 3 rows</li><li>• 4 rows</li></ul>	A	<b>8GB4 561</b>		1	1	032	0.900
		A	<b>8GB4 562</b>		1	1	032	1.100
		A	<b>8GB4 563</b>		1	1	032	1.300
		A	<b>8GB4 564</b>		1	1	032	1.500

8GB4 563

More information about ALPHA distribution boards, ALPHA SIMBOX small distribution boards and intermediate frames can be found in the Catalog ET A1, Chapter ALPHA SIMBOX Small Distribution Boards.

### More information

More information about additional components for miniature circuit breakers can be found in Catalog ET B1 · 2010. The current issue of the catalog can be downloaded from [www.siemens.com/e-installation-catalogs](http://www.siemens.com/e-installation-catalogs).

\* You can order this quantity or a multiple thereof.

# BETA Protecting Miniature Circuit Breakers (MCBs)

Busbars  
Standard 5ST3 6, 5ST3 7

## Overview

The busbar system with pin-type connections can be used for all 5SJ6 . . . -KS and 5SY miniature circuit breakers with or without mounted auxiliary switch (AS) or fault signal contact (FC).

Busbars in 10 mm<sup>2</sup> and 16 mm<sup>2</sup> versions are available.

The 5ST3 7 busbar system with busbars that can be cut to any length required.

The extremely flexible 5ST3 6 busbar system with fixed lengths also enables installation in any length as the busbars can be overlapped. No further need for time-consuming tasks, such as cutting, cutting to length, deburring, cleaning of cut surfaces and mounting of end caps.

Any free pins on the busbars can be made finger-safe by covering with touch protection.

For further information on bus-mounting miniature circuit breakers with residual current operated circuit breakers, please refer to the chapter "Residual current protective devices".

## Benefits

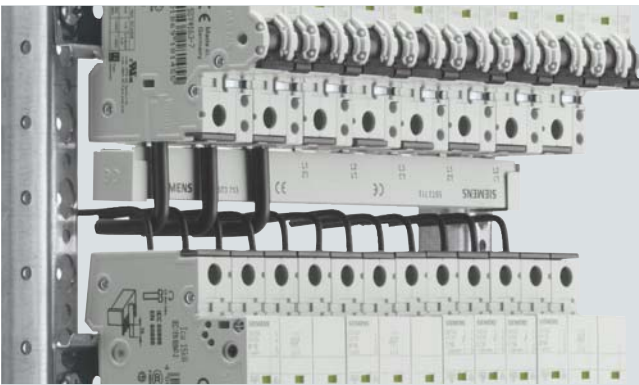

- Between the devices, the busbar, located at the bottom and behind the conductor, provides an optimum wiring space with easy view of the inserted conductor. This enables easy control of connections.

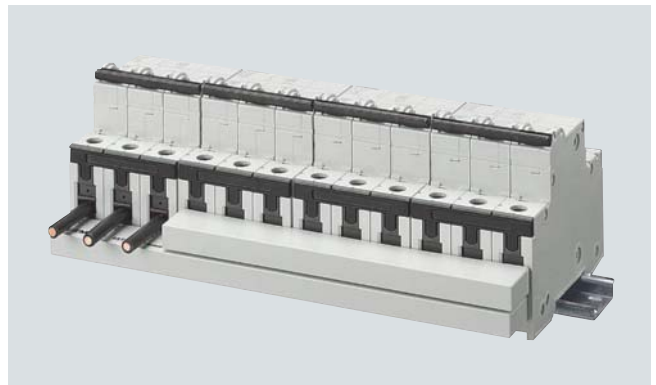

- The ability to overlap the busbar mounting enables a cross-section enlargement of up to 32 mm<sup>2</sup> using the respective components, 10 and 16 mm<sup>2</sup>.



- Combinations of any number of units are possible by overlapping the fixed-length busbars.

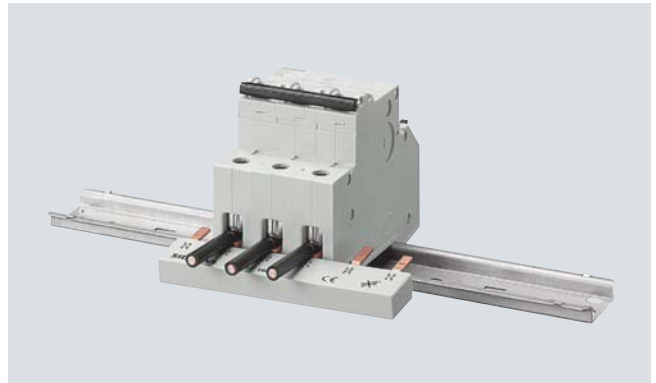







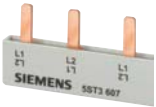
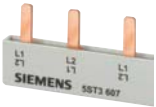

- The fact that the connection of the conductor is always clearly visible facilitates control and insertion of conductors of all pole types and considerably reduces mounting times.

# BETA Protecting Miniature Circuit Breakers (MCBs)

Busbars  
Standard 5ST3 6, 5ST3 7

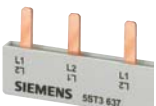
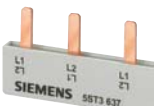
## Selection and ordering data

	Pin spacing	Length	DT	Order No.	Price per PU	PU	PS*	PG	Weight per PU approx.	
	MW	mm				Unit(s)	Unit(s)		kg	
<b>5ST3 6 busbar system, 10 mm<sup>2</sup>, for miniature circuit breakers</b>										
<b>Fixed lengths, cannot be cut, fully insulated</b>										
Single-phase										
	For 2 MCB 1P	1	33	A	<b>5ST3 600</b>		1	10	027	0.005
	For 6 MCB 1P		105	A	<b>5ST3 601</b>		1	10	027	0.018
	For 12 MCB 1P		210	A	<b>5ST3 602</b>		1	10	027	0.036
Single-phase For MCB with AS or FC										
	For 2 MCB 1P	1.5	40	A	<b>5ST3 603</b>		1	10	027	0.008
	For 6 MCB 1P		156,5	A	<b>5ST3 604</b>		1	10	027	0.024
	For 9 MCB 1P		237	A	<b>5ST3 605</b>		1	10	027	0.036
Two-phase										
	For 2 MCB 2P	1	75,5	A	<b>5ST3 606</b>		1	10	027	0.016
	For 3 MCB 2P		105	A	<b>5ST3 607</b>		1	10	027	0.024
	For 6 MCB 2P		210	A	<b>5ST3 608</b>		1	10	027	0.048
Three-phase										
	For 2 MCB 3P	1	102	A	<b>5ST3 613</b>		1	10	027	0.039
	For 3 MCB 3P		157,5	A	<b>5ST3 614</b>		1	10	027	0.060
	For 4 MCB 3P		210	A	<b>5ST3 615</b>		1	10	027	0.076
Three-phase For MCB with AS or FC										
	For 2 MCB 3P	1+1+1.5	115	A	<b>5ST3 616</b>		1	10	027	0.040
	For 4 MCB 3P		237	A	<b>5ST3 617</b>		1	10	027	0.080
	For 6 MCB 1P	1.5	125	A	<b>5ST3 618</b>		1	10	027	0.044
For 9 MCB 1P		229	A	<b>5ST3 620</b>		1	10	027	0.066	
4-phase										
	For 2 MCB 4P or 3P+N	1	145	A	<b>5ST3 621</b>		1	10	027	0.051
	For 3 MCB 4P or 3P+N		215	A	<b>5ST3 622</b>		1	10	027	0.078
	For 6 MCB 2P or 1P+N		215	A	<b>5ST3 623</b>		1	10	027	0.078
Three-phase										
	For 1 RC unit 4P N right and 8 MCB 1P	1	210	A	<b>5ST3 624</b>		1	10	027	0.075
	For 1 RC unit 4P N left and 8 MCB 1P	1	192	A	<b>5ST3 667</b>		1	10	027	0.061
<b>5ST3 6 busbars, 16 mm<sup>2</sup>, for miniature circuit breakers</b>										
<b>Fixed lengths, cannot be cut, fully insulated</b>										
Single-phase										
	For 2 MCB 1P	1	33	A	<b>5ST3 630</b>		1	10	027	0.008
	For 6 MCB 1P		105	A	<b>5ST3 631</b>		1	10	027	0.025
	For 12 MCB 1P		210	A	<b>5ST3 632</b>		1	10	027	0.048
Single-phase For MCB with AS or FC										
	For 2 MCB 1P	1.5	40	A	<b>5ST3 633</b>		1	10	027	0.013
	For 6 MCB 1P		156,5	A	<b>5ST3 634</b>		1	10	027	0.039
	For 9 MCB 1P		237	A	<b>5ST3 635</b>		1	10	027	0.059
Two-phase										
	For 2 MCB 2P	1	75,5	A	<b>5ST3 636</b>		1	10	027	0.024
	For 3 MCB 2P		105	A	<b>5ST3 637</b>		1	10	027	0.039
	For 6 MCB 2P		210	A	<b>5ST3 638</b>		1	10	027	0.076
Two-phase For MCB with AS or FC										
	For 2 MCB 2P	1 + 1.5	75,5	A	<b>5ST3 640</b>		1	10	027	0.026
	For 3 MCB 2P		120,5	A	<b>5ST3 641</b>		1	10	027	0.045
	For 5 MCB 2P		210	A	<b>5ST3 642</b>		1	10	027	0.084

\* You can order this quantity or a multiple thereof.



# BETA Protecting Miniature Circuit Breakers (MCBs)





Busbars  
Standard 5ST3 6, 5ST3 7

	Pin spacing	Length	DT	Order No.	Price per PU	PU	PS*	PG	Weight per PU approx.
	MW	mm				Unit(s)	Unit(s)		kg
<b>5ST3 6 busbars, 16 mm<sup>2</sup>, for miniature circuit breakers</b>									
<b>Fixed lengths, cannot be cut, fully insulated</b>									
Three-phase									
For 2 MCB 3P	1	102,5	A	<b>5ST3 643</b>		1	10	027	0.058
For 3 MCB 3P		157,5	A	<b>5ST3 644</b>		1	10	027	0.083
For 4 MCB 3P		210	▶	<b>5ST3 645</b>		1	10	027	0.110
Three-phase For MCB with AS or FC									
For 2 MCB 3P	1+1+1.5	115	A	<b>5ST3 646</b>		1	10	027	0.060
For 4 MCB 3P		237	A	<b>5ST3 647</b>		1	10	027	0.120
For 6 MCB 1P	1.5	156	A	<b>5ST3 648</b>		1	10	027	0.061
For 9 MCB 1P		245	A	<b>5ST3 650</b>		1	10	027	0.093
<b>5ST3 6 busbars, 16 mm<sup>2</sup>, for miniature circuit breakers</b>									
<b>Fixed lengths, cannot be cut, fully insulated</b>									
4-phase									
For 2 MCB 4P or 3P+N	1		A	<b>5ST3 651</b>		1	10	027	0.080
For 3 MCB 4P or 3P+N			A	<b>5ST3 652</b>		1	10	027	0.116
For 6 MCB 2P or 1P+N			A	<b>5ST3 653</b>		1	10	027	0.116
Three-phase									
For 1 RC unit 4P N right and 8 MCB 1P	1	210	A	<b>5ST3 654</b>		1	10	027	0.114
For 1 RC unit 4P N left and 8 MCB 1P	1	210	A	<b>5ST3 668</b>		1	10	027	0.099
<b>Touch protection for free terminals</b>									
Yellow, RAL 1004 5 x 1 pin									
			A	<b>5ST3 655</b>		1	10	027	0.003
<b>Assortments</b>									
10 mm <sup>2</sup>									
20 x 5ST3 613 + 10 x 5ST3 614 + 50 x 5ST3 615 + 50 x 5ST3 655				A	<b>5ST3 656</b>	1 set	1 set	027	5.490
16 mm <sup>2</sup>									
20 x 5ST3 643 + 10 x 5ST3 644 + 50 x 5ST3 645 + 50 x 5ST3 655				A	<b>5ST3 657</b>	1 set	1 set	027	7.640
<b>5ST3 7 busbar system, 10 mm<sup>2</sup>, 12 MW</b>									
<b>For miniature circuit breakers</b>									
<b>Can be cut, with end caps</b>									
Single-phase, angled									
For 12 MCB 1P	1	214	A	<b>5ST3 730</b>		1	1	027	0.040
For 9 MCB 1P with AS or FC	1.5		A	<b>5ST3 732</b>		1	1	027	0.040
Two-phase									
For 6 MCB 2P	1		A	<b>5ST3 734</b>		1	1	027	0.060
For 4 MCB 2P with AS or FC	1+1.5		A	<b>5ST3 736</b>		1	1	027	0.060
Three-phase									
For 4 MCB 3P	1		▶	<b>5ST3 738</b>		1	1	027	0.100
For 3 MCB 3P with AS or FC	1+1+1.5		A	<b>5ST3 741</b>		1	1	027	0.100
For 3 MCB 1P with AS or FC	1.5		A	<b>5ST3 743</b>		1	1	027	0.100
4-phase									
For 3 MCB 4P or 3P+N	1		A	<b>5ST3 745</b>		1	1	027	0.150
<b>5ST3 7 busbar system, 10 mm<sup>2</sup>, 56 MW</b>									
<b>For miniature circuit breakers</b>									
<b>Can be cut, without end caps</b>									
Single-phase, angled									
For MCB 1P	1	1016	A	<b>5ST3 731</b>		1	1	027	0.190
For MCB 1P with AS or FC	1.5		A	<b>5ST3 733</b>		1	1	027	0.190
Two-phase									
For MCB 2P	1		A	<b>5ST3 735</b>		1	1	027	0.290
For MCB 2P with AS or FC	1+1.5		A	<b>5ST3 737</b>		1	1	027	0.290
Three-phase									
For MCB 3P	1		A	<b>5ST3 740</b>		1	1	027	0.430
For MCB 3P with AS or FC	1+1+1.5		A	<b>5ST3 742</b>		1	1	027	0.430
For MCB 1P with AS or FC	1.5		A	<b>5ST3 744</b>		1	1	027	0.430
4-phase									
For MCB 4P or 3P+N	1		A	<b>5ST3 746</b>		1	1	027	0.700

\* You can order this quantity or a multiple thereof.

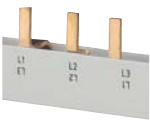
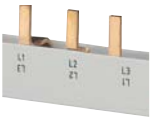
# BETA Protecting Miniature Circuit Breakers (MCBs)

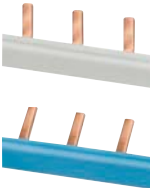
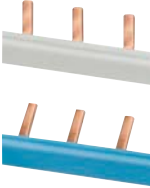
## Busbars Standard 5ST3 6, 5ST3 7

	Pin spacing	Length	DT	Order No.	Price per PU	PU	PS*	PG	Weight per PU approx.	
	MW	mm				Unit(s)	Unit(s)		kg	
	<b>5ST3 7 busbar system, 16 mm<sup>2</sup>, 12 MW</b> <b>For miniature circuit breakers</b> <b>Can be cut, without end caps</b>									
	Single-phase, angled									
	For MCB 1P	1	214	▶	<b>5ST3 700</b>		1	1	027	0.040
	For MCB 1P with AS or FC	1.5		A	<b>5ST3 702</b>		1	1	027	0.040
	Two-phase									
	For MCB 2P	1		A	<b>5ST3 704</b>		1	1	027	0.060
	For MCB 2P with AS or FC	1+1.5		A	<b>5ST3 706</b>		1	1	027	0.060
	Three-phase									
	For MCB 3P	1		▶	<b>5ST3 708</b>		1	1	027	0.100
	For MCB 3P with AS or FC	1+1+1.5		A	<b>5ST3 711</b>		1	1	027	0.100
For MCB 1P with AS or FC	1.5		A	<b>5ST3 713</b>		1	1	027	0.100	
4-phase										
For MCB 4P or 3P+N	1		A	<b>5ST3 715</b>		1	1	027	0.150	
	<b>5ST3 7 busbar system, 16 mm<sup>2</sup>, 56 MW</b> <b>For miniature circuit breakers</b> <b>Can be cut, without end caps</b>									
	Single-phase, angled									
	For MCB 1P	1	1016	A	<b>5ST3 701</b>		1	1	027	0.190
	For MCB 1P with AS or FC	1.5		A	<b>5ST3 703</b>		1	1	027	0.190
	Two-phase									
	For MCB 2P	1		A	<b>5ST3 705</b>		1	1	027	0.290
	For MCB 2P with AS or FC	1+1.5		A	<b>5ST3 707</b>		1	1	027	0.290
	Three-phase									
	For MCB 3P	1		▶	<b>5ST3 710</b>		1	1	027	0.430
	For MCB 3P with AS or FC	1+1+1.5		A	<b>5ST3 712</b>		1	1	027	0.430
For MCB 1P with AS or FC	1.5		A	<b>5ST3 714</b>		1	1	027	0.430	
4-phase										
For MCB 4P or 3P+N	1		A	<b>5ST3 716</b>		1	1	027	0.700	
	<b>End caps for 5ST3 7, can be cut</b>									
	For single-phase busbars									
				▶	<b>5ST3 748</b>		1	10	027	0.001
	For two- and three-phase busbars									
			▶	<b>5ST3 750</b>		1	10	027	0.001	
For 4-phase busbars										
			▶	<b>5ST3 718</b>		1	10	027	0.001	
	<b>5ST3 7 busbar system, 10 mm<sup>2</sup>, 12 MW</b> <b>For MCBs 1+N in 1 MW of the compact range,</b> <b>can be cut, with end caps</b>									
	Single-phase									
	For 12 MCB 1+N, gray		216	A	<b>5ST3 762</b>		1	10	027	0.029
	For 12 MCB 1+N, blue			A	<b>5ST3 763</b>		1	10	027	0.029
	<b>5ST3 7 busbar system, 10 mm<sup>2</sup>, 56 MW</b> <b>For MCBs 1+N in 1 MW of the compact range,</b> <b>can be cut, without end caps</b>									
	Single-phase									
	For MCBs 1+N, gray		1016	A	<b>5ST3 764</b>		1	10	027	0.134
	For MCBs 1+N, blue			A	<b>5ST3 765</b>		1	10	027	0.134
	<b>End caps for 5ST3 76</b>									
	1 set comprises a right and a left cap									
	Gray			A	<b>5ST3 766</b>		1 set	10 sets	027	
Blue			A	<b>5ST3 767</b>		1 set	10 sets	027		
	<b>Terminals for 5ST3 76</b>									
	Terminal version S For conductors up to 25 mm <sup>2</sup>									
			A	<b>5ST3 768</b>		1	25	027	0.011	

\* You can order this quantity or a multiple thereof.

# BETA Protecting Miniature Circuit Breakers (MCBs)

Busbars  
according to UL 508, 5ST3 7...-HG

## Overview

Products according to UL standards are used in North America, but also in several other countries. In particular when exporting machines or electrical switchgear and equipment to the USA, acceptance and delivery are possible only if the relevant UL standards are satisfied.

The 5ST3 7...-HG busbar system according to UL 508 and CSA is suitable for universal use worldwide with all 5SY and 5SP miniature circuit breakers for Supplementary Protection certified according to UL 1077 as well as for 3NW and 3NC fuse holders certified according to UL 512.

The busbars are available in single-, two- and three-phase version with different pin spacings and with two cross-sections 18 mm<sup>2</sup> and 25 mm<sup>2</sup>. Infeed can be directly into the terminals of the miniature circuit breaker or through connection terminals. The connection terminals are available in two versions – for direct infeed at the busbar or for infeed directly at the miniature circuit breaker/fuse holder. Pins that are not required can be covered with touch protection covers.

## Benefits

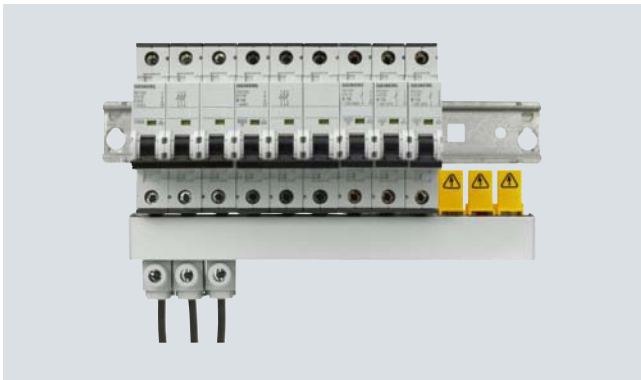

- Bus mounting with infeed through a connection terminal directly on the miniature circuit breaker up to a conductor cross-section of 35 mm<sup>2</sup>.



- Infeed directly on the miniature circuit breaker up to a cross-section of 35 mm<sup>2</sup> and connection terminal for connection directly on the busbar up to a conductor cross-section of 50 mm<sup>2</sup>.
- Suitable for universal use according to both IEC and UL standards
- Can be used for 5SY, 5SP miniature circuit breakers and for Class CC, cylindrical and SITOR fuse holders
- UL-tested combination – device and busbar
- Different cross-sections 18 mm<sup>2</sup> and 25 mm<sup>2</sup>





- Bus mounting with infeed at the fuse holder for conductor cross-sections up to 35 mm<sup>2</sup>

# BETA Protecting Miniature Circuit Breakers (MCBs)

Busbars  
according to UL 508, 5ST3 7 . . . - . HG

## Selection and ordering data

	Pin spacing	Length	DT	Order No.	Price per PU	PU	PS*	PG	Weight per PU approx.										
	MW	mm				Unit(s)	Unit(s)		kg										
<b>5ST3 7 . . . HG busbars according to UL 508, 18 mm<sup>2</sup>, can be cut, without end caps</b>																			
	Single-phase																		
	<ul style="list-style-type: none"> <li>For MCB 1P (5SY) or fuse holder 10 x 38 Class CC (3NC1 091, 3NW7 513-0HG)</li> <li>For MCB 1P (5SY, 5SP) with AS or FC or fuse holder 14 x 51 (3NC1 491, 3NW7 111)</li> </ul>	1	1000	A	<b>5ST3 701-0HG</b>		1	10	012	0.330									
	Two-phase																		
	<ul style="list-style-type: none"> <li>For MCB 2P (5SY) or fuse holder 10 x 38/Class CC (3NC1 092, 3NW7 523-0HG)</li> <li>For MCB 2P (5SY) with AS or FC</li> </ul>	1	1000	A	<b>5ST3 705-0HG</b>		1	10	012	0.508									
	Three-phase																		
	<ul style="list-style-type: none"> <li>For MCB 3P (5SY) or fuse holder 10 x 38/Class CC (3NC1 093, 3NW7 533-0HG)</li> </ul>	1	1000	A	<b>5ST3 710-0HG</b>		1	10	012	0.800									
	<ul style="list-style-type: none"> <li>For MCB 3P (5SY) with AS or FC</li> <li>For MCB 1P (5SY, 5SP) with AS or FC or fuse holder 14 x 51 (3NC1 493, 3NW7 131)</li> </ul>	1+1+1.5	1000	A	<b>5ST3 712-0HG</b>		1	10	012	0.800									
	1.5	1000	A	<b>5ST3 714-0HG</b>		1	10	012	0.820										
<b>5ST3 7 . . . HG busbars according to UL 508, 25 mm<sup>2</sup>, can be cut, without end caps</b>																			
	Single-phase																		
	<ul style="list-style-type: none"> <li>For MCB 1P (5SP) or fuse holder 14 x 51 (3NC1 491, 3NW7 111)</li> </ul>	1.5	1000	A	<b>5ST3 701-2HG</b>		1	10	012	0.450									
	Two-phase																		
	<ul style="list-style-type: none"> <li>For MCB 2P (5SP) or fuse holder 14 x 51 (3NC1 492, 3NW7 121)</li> </ul>	1.5	1000	A	<b>5ST3 705-2HG</b>		1	10	012	0.690									
	Three-phase																		
	<ul style="list-style-type: none"> <li>For MCB 3P (5SP) or fuse holder 14 x 51 (3NC1 493, 3NW7 131)</li> </ul>	1.5	1000	A	<b>5ST3 710-2HG</b>		1	10	012	1.090									
<b>End caps for 5ST3 7 . . . HG</b>																			
	<ul style="list-style-type: none"> <li>For single-phase busbars</li> <li>For two- and three-phase busbars</li> </ul>																		
				A	<b>5ST3 748-0HG</b>		1	10	012	0.001									
			A	<b>5ST3 750-0HG</b>		1	10	012	0.001										
<b>Connection terminals according to UL 508</b>																			
	Infeed to device																		
	<ul style="list-style-type: none"> <li>35 mm<sup>2</sup></li> </ul>			A	<b>5ST3 770-0HG</b>		1	10	012	0.035									
	Infeed to busbar																		
	<ul style="list-style-type: none"> <li>50 mm<sup>2</sup></li> </ul>			A	<b>5ST3 770-1HG</b>		1	10	012	0.016									
<b>Touch protection covers for busbars acc. to UL 508</b>																			
	<ul style="list-style-type: none"> <li>5 x 1 pin</li> </ul>																		
				A	<b>5ST3 655-0HG</b>		1	10	012	0.003									

\* You can order this quantity or a multiple thereof.

# BETA Protecting Miniature Circuit Breakers (MCBs)

Busbars  
Universal, 5ST3 5

## Overview

Busbars serve the safe and fast connection of modular installation devices, such as miniature circuit breakers, residual current operated circuit breakers and switching and control devices.

With the universal busbar system, different devices - with and without additional components and in various versions - can be

quickly and easily connected with each other by means of a few components for numerous possible applications. For example, residual current operated circuit breakers 3+N can be combined with miniature circuit breakers 1+N in a single modular width for cost-effective splitting of the phases.

## Benefits

- The universal busbar system can be used for all modular installation devices such as 5SY, 5SX, 5SM, 5SU
- A safe bus-mounting system can be quickly assembled with few components

- Individual connection of devices using standardized connection pins, with plug-in design for easy and comfortable connecting
- Free choice of phase sequence

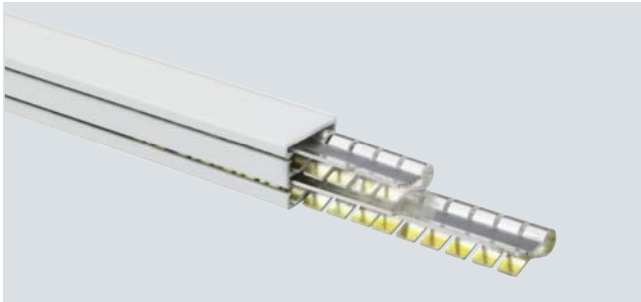

- Two-phase insulating parts with plug-on mount for implementing two-phase or multi-phase bus mounting

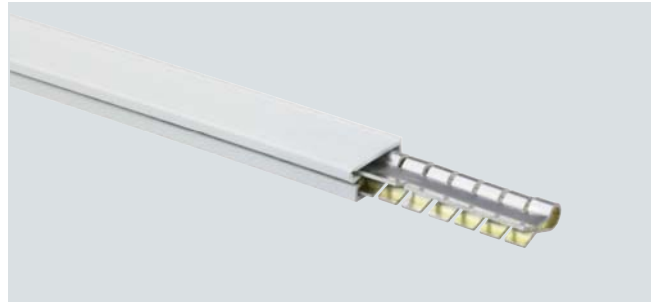

- Single-phase insulating parts with plug-on mount for implementing single-phase or multi-phase bus mounting

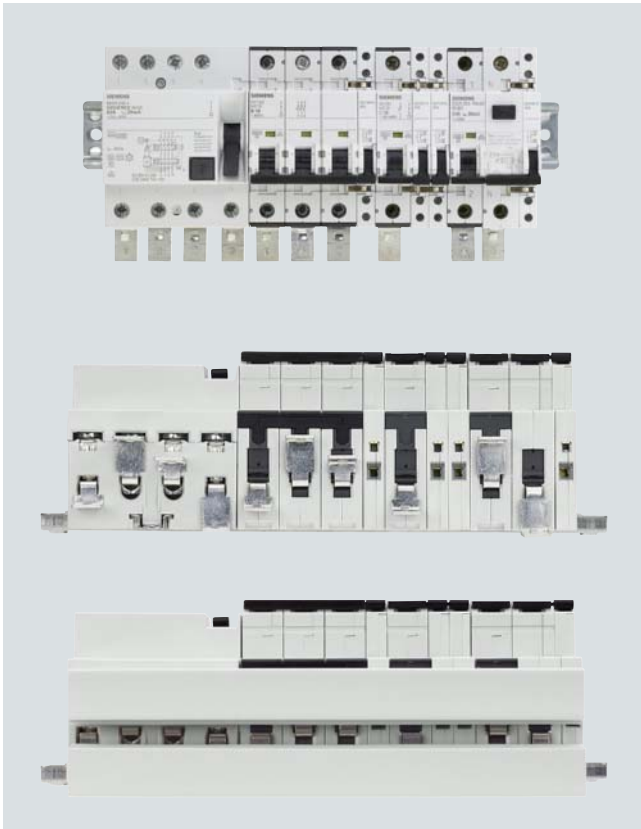

- Universal multi-phase bus mounting of 3 phases + N with 2 x two-phase insulating parts with plug-on mount for combination of different modular installation devices with additional components











- Single-phase bus mounting with one single-phase insulating part with plug-on mount for combination of RCCB and MCB

# BETA Protecting Miniature Circuit Breakers (MCBs)

## Busbars Universal, 5ST3 5

### Selection and ordering data

	Length	DT	Order No.	Price per PU	PU	PS*	PG	Weight per PU approx.
	mm				Unit(s)	Unit(s)		kg
	<b>Universal busbar system, 16 mm<sup>2</sup>, 1000 mm, can be cut, without end caps</b>							
	1000	A	<b>5ST3 500-0</b>		1	12	027	0.433
	<b>Universal busbar system, 16 mm<sup>2</sup>, 1000 mm, can be cut, without end caps</b>							
	1000	A	<b>5ST3 501-0</b>		1	12	027	0.823
	<b>Connection pins, terminal spacing 1 MW for RCCBs or MCBs</b>							
	12	A	<b>5ST3 510-0</b>		1	50	027	0.007
	<b>Connection pins, terminal spacing 1 MW for RCCBs or MCBs</b>							
	21	A	<b>5ST3 511-0</b>		1	50	027	0.008
 	<b>Connection pins, terminal spacing 0.5 MW for MCBs 1 + N in a single modular width</b>							
	23	A	<b>5ST3 512-0</b>		1	50	027	0.006
	3	A	<b>5ST3 513-0</b>		1	50	027	0.005
	9	A	<b>5ST3 514-0</b>		1	50	027	0.005
	21	A	<b>5ST3 515-0</b>		1	50	027	0.005
<b>Accessories</b>								
 	<b>Touch protection profiles</b>							
	1000	A	<b>5ST3 507-0</b>		1	12	027	0.003
<b>End caps</b>		A	<b>5ST3 508-0</b>		1	12	027	0.020
1 unit for 3 phases + N or can be divided into 1 x 2-phase or 2 x 1-phase insulating part								

\* You can order this quantity or a multiple thereof.

# BETA Protecting Miniature Circuit Breakers (MCBs)

Miniature circuit breakers  
according to UL 489 and IEC, 5SJ4 ... - . HG

## Overview

UL standards are applied in North America and a number of other countries. This is of particular importance to European exporters of electrical switchgear equipment for machines who export to the USA, as their products will only be accepted if they meet the relevant UL standards.

Countless devices from the Siemens low-voltage circuit protection range comply with UL standards and are therefore suitable for implementation worldwide in both IEC/EN and UL applications within the framework of their specified use.

Miniature circuit breakers certified to UL 489 permit use as an all-round solution for protection tasks in distribution boards, control cabinets and control systems to UL 508A as "branch protectors". In particular, they are also approved for the protection of electrical circuits in heating, ventilation and air conditioning systems (HVAC), as well as for DC applications up to 60 V/125 V.

This covers a wide range of protection tasks, in residential and non-residential buildings, as well as in industry. The tripping characteristics B, C and D to EN/IEC 60898 have been adapted so that they fall in the permissible tripping range to UL 489, as well as for applications at 25 °C and 40 °C.

This means that the devices are approved for use according to both standards. The enclosure dimensions of the devices correspond to DIN format. This means that the device series are suitable for universal use worldwide to IEC or UL standards.

The key difference between the three device series is their application in different power supply systems.

- 5SJ4 ...-HG40: 240/120 V AC, 1-pole, "same polarity only",
- 5SJ4 ...-HG41: 240 V AC, 1, 2 and 3-pole,
- 5SJ4 ...-HG42: 480Y/277 V AC, 1, 2 and 3-pole.

The terminals are suitable for "field wiring". This means that the devices can be installed not only in factory-finished distribution boards and control cabinets, but also on-site in a customer system.

All additional components such as auxiliary switches (AS), fault signal contacts (FC) and shunt trips (ST) are mountable on the miniature circuit breakers according to UL 489 and IEC 5SJ4 ...-HG. Captive metal brackets on the additional components ensure fast and reliable mounting on the miniature circuit breakers.

Single-, two- and three-phase busbars in 3 lengths with 6, 12 or 18 pins are available as accessories for all device series. The in-feed is over connection terminals, which are available in two versions, for direct infeed at either the busbar or the miniature circuit breakers. Pins that are not required can be covered with touch protection covers.

## Benefits

- Can be used globally for all applications in residential, non-residential and industrial buildings. This facilitates the planning of plants and enhances export opportunities
- The devices can be used according to IEC/EN 60898 and UL 489, which means these devices can be installed anywhere in the world.
- Miniature circuit breakers with 480Y/277 V to 40 A, with 240/120 V and 240 V to 63 A
- Can be used with both alternating voltage and direct voltage up to 125 V
- Rated switching capacity up to 14 kA according to UL 489 and up to 15 kA according to IEC 60947-2
- Quick mounting with busbars up to 115 A and feeder terminals up to 50 mm<sup>2</sup>.

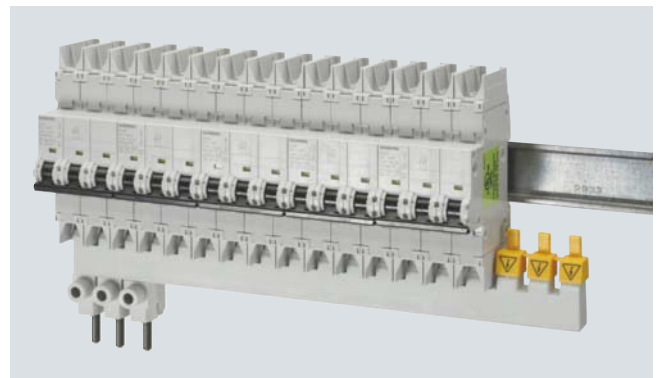

- Infeed direct at miniature circuit breaker for conductor cross-sections up to 35 mm<sup>2</sup>



- Busbar mounting with central infeed directly on the busbar up to conductor cross-section of 50 mm<sup>2</sup>



- Accessories: Auxiliary switches, fault signal contacts and shunt trips up to 480 V can be easily mounted on these miniature circuit breakers.

# BETA Protecting Miniature Circuit Breakers (MCBs)

Miniature circuit breakers  
according to UL 489 and IEC, 5SJ4 . . . - . HG

## Selection and ordering data

$I_n$	Width	DT	Characteristic B		Price per PU	PU	PS*	PG	Weight per PU approx.
			Order No.	Unit(s)					
A	MW <sup>1)</sup>					Unit(s)	Unit(s)		kg
<b>MCBs "same polarity only" 1P, 240 V AC</b>									
6	1	B	5SJ4 106-6HG40			1	1	012	0.120
10		B	5SJ4 110-6HG40			1	1	012	0.120
13		C	5SJ4 113-6HG40			1	1	012	0.120
15		C	5SJ4 118-6HG40			1	1	012	0.120
16		C	5SJ4 116-6HG40			1	1	012	0.120
20		C	5SJ4 120-6HG40			1	1	012	0.120
25		C	5SJ4 125-6HG40			1	1	012	0.120
30		C	5SJ4 130-6HG40			1	1	012	0.120
32		C	5SJ4 132-6HG40			1	1	012	0.120
35		C	5SJ4 135-6HG40			1	1	012	0.120
40		C	5SJ4 140-6HG40			1	1	012	0.120
45		C	5SJ4 145-6HG40			1	1	012	0.120
50		C	5SJ4 150-6HG40			1	1	012	0.120
60		C	5SJ4 160-6HG40			1	1	012	0.120
63		C	5SJ4 163-6HG40			1	1	012	0.120



<sup>1)</sup> 1 MW (modular width) = 18 mm.

$I_n$	Width	DT	Characteristic C			Characteristic D			Price per PU	PU	PS*	PG	Weight per PU approx.
			Order No.	Price per PU	PG	DT	Order No.	Price per PU					
A	MW <sup>1)</sup>								Unit(s)	Unit(s)		kg	
<b>MCBs "same polarity only" 1P, 240 V AC</b>													
0.3	1	C	5SJ4 114-7HG40		012	C	5SJ4 114-8HG40		1	1	012	0.120	
0.5		C	5SJ4 105-7HG40		012	C	5SJ4 105-8HG40		1	1	012	0.120	
1		B	5SJ4 101-7HG40		012	C	5SJ4 101-8HG40		1	1	012	0.120	
1.6		C	5SJ4 115-7HG40		012	C	5SJ4 115-8HG40		1	1	012	0.120	
2		B	5SJ4 102-7HG40		012	C	5SJ4 102-8HG40		1	1	012	0.120	
3		B	5SJ4 103-7HG40		012	C	5SJ4 103-8HG40		1	1	012	0.120	
4		B	5SJ4 104-7HG40		012	C	5SJ4 104-8HG40		1	1	012	0.120	
5		C	5SJ4 111-7HG40		012	C	5SJ4 111-8HG40		1	1	012	0.120	
6		B	5SJ4 106-7HG40		012	C	5SJ4 106-8HG40		1	1	012	0.120	
8		B	5SJ4 108-7HG40		012	C	5SJ4 108-8HG40		1	1	012	0.120	
10		B	5SJ4 110-7HG40		012	C	5SJ4 110-8HG40		1	1	012	0.120	
13		C	5SJ4 113-7HG40		012	C	5SJ4 113-8HG40		1	1	012	0.120	
15		C	5SJ4 118-7HG40		012	C	5SJ4 118-8HG40		1	1	012	0.120	
16		B	5SJ4 116-7HG40		012	C	5SJ4 116-8HG40		1	1	012	0.120	
20		B	5SJ4 120-7HG40		012	C	5SJ4 120-8HG40		1	1	012	0.120	
25		B	5SJ4 125-7HG40		012	C	5SJ4 125-8HG40		1	1	012	0.120	
30		C	5SJ4 130-7HG40		012	C	5SJ4 130-8HG40		1	1	012	0.120	
32		C	5SJ4 132-7HG40		012	C	5SJ4 132-8HG40		1	1	012	0.120	
35		C	5SJ4 135-7HG40		012	C	5SJ4 135-8HG40		1	1	012	0.120	
40		C	5SJ4 140-7HG40		012	C	5SJ4 140-8HG40		1	1	012	0.120	
45		C	5SJ4 145-7HG40		012	C	5SJ4 145-8HG40		1	1	012	0.120	
50		C	5SJ4 150-7HG40		012	C	5SJ4 150-8HG40		1	1	012	0.120	
60		C	5SJ4 160-7HG40		012	C	5SJ4 160-8HG40		1	1	012	0.120	
63		C	5SJ4 163-7HG40		012	C	5SJ4 163-8HG40		1	1	012	0.120	



<sup>1)</sup> 1 MW (modular width) = 18 mm.

\* You can order this quantity or a multiple thereof.



# BETA Protecting Miniature Circuit Breakers (MCBs)



Miniature circuit breakers  
according to UL 489 and IEC, 5SJ4 . . . - . HG

$I_n$	Width	DT	Characteristic C			Characteristic D			PU	PS*	PG	Weight per PU approx.
			Order No.	Price per PU	PG DT	Order No.	Price per PU	PG DT				
A	MW <sup>1)</sup>							Unit(s)	Unit(s)		kg	
<b>MCBs 1P, 240 V AC</b>												
0.3	1	C	5SJ4 114-7HG41		012 C	5SJ4 114-8HG41		1	1	012	0.155	
0.5		C	5SJ4 105-7HG41		012 C	5SJ4 105-8HG41		1	1	012	0.155	
1		C	5SJ4 101-7HG41		012 C	5SJ4 101-8HG41		1	1	012	0.155	
1.6		C	5SJ4 115-7HG41		012 C	5SJ4 115-8HG41		1	1	012	0.155	
2		C	5SJ4 102-7HG41		012 C	5SJ4 102-8HG41		1	1	012	0.155	
3		C	5SJ4 103-7HG41		012 C	5SJ4 103-8HG41		1	1	012	0.155	
4		C	5SJ4 104-7HG41		012 C	5SJ4 104-8HG41		1	1	012	0.155	
5		C	5SJ4 111-7HG41		012 C	5SJ4 111-8HG41		1	1	012	0.155	
6		C	5SJ4 106-7HG41		012 C	5SJ4 106-8HG41		1	1	012	0.155	
8		C	5SJ4 108-7HG41		012 C	5SJ4 108-8HG41		1	1	012	0.155	
10		C	5SJ4 110-7HG41		012 C	5SJ4 110-8HG41		1	1	012	0.155	
13		C	5SJ4 113-7HG41		012 C	5SJ4 113-8HG41		1	1	012	0.155	
15		C	5SJ4 118-7HG41		012 C	5SJ4 118-8HG41		1	1	012	0.155	
16		C	5SJ4 116-7HG41		012 C	5SJ4 116-8HG41		1	1	012	0.155	
20		C	5SJ4 120-7HG41		012 C	5SJ4 120-8HG41		1	1	012	0.155	
25		C	5SJ4 125-7HG41		012 C	5SJ4 125-8HG41		1	1	012	0.155	
30		C	5SJ4 130-7HG41		012 C	5SJ4 130-8HG41		1	1	012	0.155	
32		C	5SJ4 132-7HG41		012 C	5SJ4 132-8HG41		1	1	012	0.155	
35		C	5SJ4 135-7HG41		012 C	5SJ4 135-8HG41		1	1	012	0.155	
40		C	5SJ4 140-7HG41		012 C	5SJ4 140-8HG41		1	1	012	0.155	
45		C	5SJ4 145-7HG41		012 C	5SJ4 145-8HG41		1	1	012	0.155	
50		C	5SJ4 150-7HG41		012 C	5SJ4 150-8HG41		1	1	012	0.155	
60		C	5SJ4 160-7HG41		012 C	5SJ4 160-8HG41		1	1	012	0.155	
63		C	5SJ4 163-7HG41		012 C	5SJ4 163-8HG41		1	1	012	0.155	
<b>MCBs 2P, 240 V AC</b>												
0.3	2	C	5SJ4 214-7HG41		012 C	5SJ4 214-8HG41		1	1	012	0.310	
0.5		C	5SJ4 205-7HG41		012 C	5SJ4 205-8HG41		1	1	012	0.310	
1		C	5SJ4 201-7HG41		012 C	5SJ4 201-8HG41		1	1	012	0.310	
1.6		C	5SJ4 215-7HG41		012 C	5SJ4 215-8HG41		1	1	012	0.310	
2		C	5SJ4 202-7HG41		012 C	5SJ4 202-8HG41		1	1	012	0.310	
3		C	5SJ4 203-7HG41		012 C	5SJ4 203-8HG41		1	1	012	0.310	
4		C	5SJ4 204-7HG41		012 C	5SJ4 204-8HG41		1	1	012	0.310	
5		C	5SJ4 211-7HG41		012 C	5SJ4 211-8HG41		1	1	012	0.310	
6		C	5SJ4 206-7HG41		012 C	5SJ4 206-8HG41		1	1	012	0.310	
8		C	5SJ4 208-7HG41		012 C	5SJ4 208-8HG41		1	1	012	0.310	
10		C	5SJ4 210-7HG41		012 C	5SJ4 210-8HG41		1	1	012	0.310	
13		C	5SJ4 213-7HG41		012 C	5SJ4 213-8HG41		1	1	012	0.310	
15		C	5SJ4 218-7HG41		012 C	5SJ4 218-8HG41		1	1	012	0.310	
16		C	5SJ4 216-7HG41		012 C	5SJ4 216-8HG41		1	1	012	0.310	
20		C	5SJ4 220-7HG41		012 C	5SJ4 220-8HG41		1	1	012	0.310	
25		C	5SJ4 225-7HG41		012 C	5SJ4 225-8HG41		1	1	012	0.310	
30		C	5SJ4 230-7HG41		012 C	5SJ4 230-8HG41		1	1	012	0.310	
32		C	5SJ4 232-7HG41		012 C	5SJ4 232-8HG41		1	1	012	0.310	
35		C	5SJ4 235-7HG41		012 C	5SJ4 235-8HG41		1	1	012	0.310	
40		C	5SJ4 240-7HG41		012 C	5SJ4 240-8HG41		1	1	012	0.310	
45		C	5SJ4 245-7HG41		012 C	5SJ4 245-8HG41		1	1	012	0.310	
50		C	5SJ4 250-7HG41		012 C	5SJ4 250-8HG41		1	1	012	0.310	
60		C	5SJ4 260-7HG41		012 C	5SJ4 260-8HG41		1	1	012	0.310	
63		C	5SJ4 263-7HG41		012 C	5SJ4 263-8HG41		1	1	012	0.310	

<sup>1)</sup> 1 MW (modular width) = 18 mm.

# BETA Protecting Miniature Circuit Breakers (MCBs)

Miniature circuit breakers  
according to UL 489 and IEC, 5SJ4 . . . - . HG

$I_n$	Width	DT	Characteristic C			Characteristic D			PU	PS*	PG	Weight per PU approx.
			Order No.	Price per PU	PG DT	Order No.	Price per PU	PG DT				
A	MW <sup>1)</sup>							Unit(s)	Unit(s)		kg	
<b>MCBs 3P, 240 V AC</b>												
	0.3	3	C	5SJ4 314-7HG41		012 C	5SJ4 314-8HG41		1	1	012	0.465
	0.5		C	5SJ4 305-7HG41		012 C	5SJ4 305-8HG41		1	1	012	0.465
	1		C	5SJ4 301-7HG41		012 C	5SJ4 301-8HG41		1	1	012	0.465
	1.6		C	5SJ4 315-7HG41		012 C	5SJ4 315-8HG41		1	1	012	0.465
	2		C	5SJ4 302-7HG41		012 C	5SJ4 302-8HG41		1	1	012	0.465
	3		C	5SJ4 303-7HG41		012 C	5SJ4 303-8HG41		1	1	012	0.465
	4		C	5SJ4 304-7HG41		012 C	5SJ4 304-8HG41		1	1	012	0.465
	5		C	5SJ4 311-7HG41		012 C	5SJ4 311-8HG41		1	1	012	0.465
	6		C	5SJ4 306-7HG41		012 C	5SJ4 306-8HG41		1	1	012	0.465
	8		C	5SJ4 308-7HG41		012 C	5SJ4 308-8HG41		1	1	012	0.465
	10		C	5SJ4 310-7HG41		012 C	5SJ4 310-8HG41		1	1	012	0.465
	13		C	5SJ4 313-7HG41		012 C	5SJ4 313-8HG41		1	1	012	0.465
	15		C	5SJ4 318-7HG41		012 C	5SJ4 318-8HG41		1	1	012	0.465
	16		C	5SJ4 316-7HG41		012 C	5SJ4 316-8HG41		1	1	012	0.465
	20		C	5SJ4 320-7HG41		012 C	5SJ4 320-8HG41		1	1	012	0.465
	25		C	5SJ4 325-7HG41		012 C	5SJ4 325-8HG41		1	1	012	0.465
	30		C	5SJ4 330-7HG41		012 C	5SJ4 330-8HG41		1	1	012	0.465
	32		C	5SJ4 332-7HG41		012 C	5SJ4 332-8HG41		1	1	012	0.465
	35		C	5SJ4 335-7HG41		012 C	5SJ4 335-8HG41		1	1	012	0.465
	40		C	5SJ4 340-7HG41		012 C	5SJ4 340-8HG41		1	1	012	0.465
	45		C	5SJ4 345-7HG41		012 C	5SJ4 345-8HG41		1	1	012	0.465
	50		C	5SJ4 350-7HG41		012 C	5SJ4 350-8HG41		1	1	012	0.465
	60		C	5SJ4 360-7HG41		012 C	5SJ4 360-8HG41		1	1	012	0.465
	63		C	5SJ4 363-7HG41		012 C	5SJ4 363-8HG41		1	1	012	0.465
<b>MCBs 1P, 480Y/277 V AC</b>												
	0.3	1	C	5SJ4 114-7HG42		012 C	5SJ4 114-8HG42		1	1	012	0.155
	0.5		C	5SJ4 105-7HG42		012 C	5SJ4 105-8HG42		1	1	012	0.155
	1		C	5SJ4 101-7HG42		012 C	5SJ4 101-8HG42		1	1	012	0.155
	1.6		C	5SJ4 115-7HG42		012 C	5SJ4 115-8HG42		1	1	012	0.155
	2		C	5SJ4 102-7HG42		012 C	5SJ4 102-8HG42		1	1	012	0.155
	3		C	5SJ4 103-7HG42		012 C	5SJ4 103-8HG42		1	1	012	0.155
	4		C	5SJ4 104-7HG42		012 C	5SJ4 104-8HG42		1	1	012	0.155
	5		C	5SJ4 111-7HG42		012 C	5SJ4 111-8HG42		1	1	012	0.155
	6		C	5SJ4 106-7HG42		012 C	5SJ4 106-8HG42		1	1	012	0.155
	8		C	5SJ4 108-7HG42		012 C	5SJ4 108-8HG42		1	1	012	0.155
	10		C	5SJ4 110-7HG42		012 C	5SJ4 110-8HG42		1	1	012	0.155
	13		C	5SJ4 113-7HG42		012 C	5SJ4 113-8HG42		1	1	012	0.155
	15		C	5SJ4 118-7HG42		012 C	5SJ4 118-8HG42		1	1	012	0.155
	16		C	5SJ4 116-7HG42		012 C	5SJ4 116-8HG42		1	1	012	0.155
	20		C	5SJ4 120-7HG42		012 C	5SJ4 120-8HG42		1	1	012	0.155
	25		C	5SJ4 125-7HG42		012 C	5SJ4 125-8HG42		1	1	012	0.155
	30		C	5SJ4 130-7HG42		012 C	5SJ4 130-8HG42		1	1	012	0.155
	32		C	5SJ4 132-7HG42		012 C	5SJ4 132-8HG42		1	1	012	0.155
	35		C	5SJ4 135-7HG42		012	--		1	1		0.155
	40		C	5SJ4 140-7HG42		012	--		1	1		0.155

<sup>1)</sup> 1 MW (modular width) = 18 mm.

# BETA Protecting Miniature Circuit Breakers (MCBs)

Miniature circuit breakers  
according to UL 489 and IEC, 5SJ4 . . . - . HG



$I_n$	Width	DT	Characteristic C			Characteristic D			PU	PS*	PG	Weight per PU approx.
			Order No.	Price per PU	PG DT	Order No.	Price per PU	PG DT				
A	MW <sup>1)</sup>							Unit(s)	Unit(s)		kg	
<b>MCBs 2P, 480Y/277 V AC</b>												
0.3	2	C	5SJ4 214-7HG42		012 C	5SJ4 214-8HG42		1	1	012	0.310	
0.5		C	5SJ4 205-7HG42		012 C	5SJ4 205-8HG42		1	1	012	0.310	
1		C	5SJ4 201-7HG42		012 C	5SJ4 201-8HG42		1	1	012	0.310	
1.6		C	5SJ4 215-7HG42		012 C	5SJ4 215-8HG42		1	1	012	0.310	
2		C	5SJ4 202-7HG42		012 C	5SJ4 202-8HG42		1	1	012	0.310	
3		C	5SJ4 203-7HG42		012 C	5SJ4 203-8HG42		1	1	012	0.310	
4		C	5SJ4 204-7HG42		012 C	5SJ4 204-8HG42		1	1	012	0.310	
5		C	5SJ4 211-7HG42		012 C	5SJ4 211-8HG42		1	1	012	0.310	
6		C	5SJ4 206-7HG42		012 C	5SJ4 206-8HG42		1	1	012	0.310	
8		C	5SJ4 208-7HG42		012 C	5SJ4 208-8HG42		1	1	012	0.310	
10		C	5SJ4 210-7HG42		012 C	5SJ4 210-8HG42		1	1	012	0.310	
13		C	5SJ4 213-7HG42		012 C	5SJ4 213-8HG42		1	1	012	0.310	
15		C	5SJ4 218-7HG42		012 C	5SJ4 218-8HG42		1	1	012	0.310	
16		C	5SJ4 216-7HG42		012 C	5SJ4 216-8HG42		1	1	012	0.310	
20		C	5SJ4 220-7HG42		012 C	5SJ4 220-8HG42		1	1	012	0.310	
25		C	5SJ4 225-7HG42		012 C	5SJ4 225-8HG42		1	1	012	0.310	
30		C	5SJ4 230-7HG42		012 C	5SJ4 230-8HG42		1	1	012	0.310	
32		C	5SJ4 232-7HG42		012 C	5SJ4 232-8HG42		1	1	012	0.310	
35		C	5SJ4 235-7HG42		012	--		1	1		0.310	
40		C	5SJ4 240-7HG42		012	--		1	1		0.310	
<b>MCBs 3P, 480Y/277 V AC</b>												
0.3	3	C	5SJ4 314-7HG42		012 C	5SJ4 314-8HG42		1	1	012	0.465	
0.5		C	5SJ4 305-7HG42		012 C	5SJ4 305-8HG42		1	1	012	0.465	
1		C	5SJ4 301-7HG42		012 C	5SJ4 301-8HG42		1	1	012	0.465	
1.6		C	5SJ4 315-7HG42		012 C	5SJ4 315-8HG42		1	1	012	0.465	
2		C	5SJ4 302-7HG42		012 C	5SJ4 302-8HG42		1	1	012	0.465	
3		C	5SJ4 303-7HG42		012 C	5SJ4 303-8HG42		1	1	012	0.465	
4		C	5SJ4 304-7HG42		012 C	5SJ4 304-8HG42		1	1	012	0.465	
5		C	5SJ4 311-7HG42		012 C	5SJ4 311-8HG42		1	1	012	0.465	
6		C	5SJ4 306-7HG42		012 C	5SJ4 306-8HG42		1	1	012	0.465	
8		C	5SJ4 308-7HG42		012 C	5SJ4 308-8HG42		1	1	012	0.465	
10		C	5SJ4 310-7HG42		012 C	5SJ4 310-8HG42		1	1	012	0.465	
13		C	5SJ4 313-7HG42		012 C	5SJ4 313-8HG42		1	1	012	0.465	
15		C	5SJ4 318-7HG42		012 C	5SJ4 318-8HG42		1	1	012	0.465	
16		C	5SJ4 316-7HG42		012 C	5SJ4 316-8HG42		1	1	012	0.465	
20		C	5SJ4 320-7HG42		012 C	5SJ4 320-8HG42		1	1	012	0.465	
25		C	5SJ4 325-7HG42		012 C	5SJ4 325-8HG42		1	1	012	0.465	
30		C	5SJ4 330-7HG42		012 C	5SJ4 330-8HG42		1	1	012	0.465	
32		C	5SJ4 332-7HG42		012 C	5SJ4 332-8HG42		1	1	012	0.465	
35		C	5SJ4 335-7HG42		012	--		1	1		0.465	
40		C	5SJ4 340-7HG42		012	--		1	1		0.465	

<sup>1)</sup> 1 MW (modular width) = 18 mm.



# BETA Protecting Miniature Circuit Breakers (MCBs)

Miniature circuit breakers  
according to UL 489 and IEC, 5SJ4 ... - .HG

## Accessories

	Width MW <sup>1)</sup>	DT	Order No.	Price per PU	PU Unit(s)	PS* Unit(s)	PG	Weight per PU approx. kg	
	<b>Auxiliary switches (AS) according to UL 489</b>								
			1 NO + 1 NC		1	1	012	0.071	
			2 NO	<b>5ST3 010-0HG</b>		1	1	012	0.050
			2 NC	<b>5ST3 011-0HG</b>		1	1	012	0.050
	<b>Fault signal contacts (FC) according to UL 489</b>								
			1 NO + 1 NC		1	1	012	0.050	
			2 NO	<b>5ST3 020-0HG</b>		1	1	012	0.050
			2 NC	<b>5ST3 021-0HG</b>		1	1	012	0.050
	<b>Shunt trips (ST) according to UL 489</b>								
			110 ... 480 V AC		1	1	012	0.098	
			24 ... 60 V AC/DC	<b>5ST3 030-0HG</b>		1	1	012	0.098
				<b>5ST3 031-0HG</b>		1	1	012	0.098

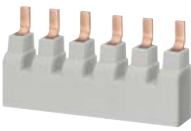
<sup>1)</sup> 1 MW (modular width) = 18 mm.

	Pin spacing MW <sup>1)</sup>	Length mm	DT	Order No.	Price per PU	PU Unit(s)	PS* Unit(s)	PG	Weight per PU approx. kg		
	<b>Busbars acc. to UL 489 specially for 5SJ4 ... -HG.. MCBs fixed lengths, cannot be cut<sup>2)</sup></b>										
			Single-phase								
			For 6 MCB 1P	1	100	A	<b>5ST3 663-0HG</b>	1	10	012	0.056
			For 12 MCB 1P		205	A	<b>5ST3 663-1HG</b>	1	10	012	0.112
			For 18 MCB 1P		310	A	<b>5ST3 663-2HG</b>	1	10	012	0.170
			Two-phase								
			For 3 MCB 2P	1	100	A	<b>5ST3 664-0HG</b>	1	10	012	0.065
			For 6 MCB 2P		205	A	<b>5ST3 664-1HG</b>	1	10	012	0.137
			For 9 MCB 2P		310	A	<b>5ST3 664-2HG</b>	1	10	012	0.211
			Three-phase								
		For 2 MCB 3P	1	100	A	<b>5ST3 665-0HG</b>	1	10	012	0.067	
		For 4 MCB 3P		205	A	<b>5ST3 665-1HG</b>	1	10	012	0.155	
		For 6 MCB 3P		310	A	<b>5ST3 665-2HG</b>	1	10	012	0.243	
  	<b>Terminals acc. to UL 489 specially for 5SJ4 ... -HG..MCBs</b>										
			Infeed on the MCB max. 35 mm <sup>2</sup>		A	<b>5ST3 666-0HG</b>	1	10	012	0.033	
		Infeed on the busbar max. 50 mm <sup>2</sup>		A	<b>5ST3 666-2HG</b>	1	10	012	0.034		

<sup>1)</sup> 1 MW (modular width) = 18 mm.



<sup>2)</sup> Any free pins on the busbars must be covered with the 5ST3 666-1HG touch protection cover.

\* You can order this quantity or a multiple thereof.

# BETA Protecting Miniature Circuit Breakers (MCBs)

Miniature circuit breakers acc. to UL 489 and IEC  
Circuit breaker terminals, 5SK9

## Miniature circuit breakers according to UL 489 and IEC, 5SJ4 ...-HG

	Pin spacing MW <sup>1)</sup>	Length mm	DT A	Order No.	Price per PU	PU Unit(s)	PS* Unit(s)	PG 012	Weight per PU approx. kg
				<b>5ST3 666-1HG</b>		1	10	012	0.003
				<b>5ST3 801</b>		1	1	027	0.008
				<b>5ST3 802</b>		1	1	027	0.027

<sup>1)</sup> 1 MW (modular width) = 18 mm.

### Overview

#### Circuit breaker terminals, 5SK9

Circuit breaker terminals are used for short-circuit protection or for protection against overloading and short-circuiting in auxiliary and control circuits after control transformers. All terminals are designed for 2 wires. The terminal block labeling accessories are used for inscription.

### Benefits





- Integration of line protection switching function in the terminal technology of control cabinets in compact 12 mm design
- Display of switching position or the "Tripped" state for the fast detection of faults
- Switching/isolating function facilitates fault locating
- Device versions with integral auxiliary switch (AS) signal the contact position
- Device versions with floating through-type connection parallel to the switching contacts facilitate line connection.

These devices are listed as "Supplementary Protectors" acc. to UL 1077 (UL Recognized Components) and CSA 235 (CSA Component Accepted).

# BETA Protecting Miniature Circuit Breakers (MCBs)

## Circuit breaker terminals, 5SK9

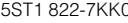
### Selection and ordering data

Version	$I_n$	DT	Order No.	Price per PU	PU	PS*	PG	Weight per PU approx.		
	A				Unit(s)	Unit(s)		kg		
	<b>Terminal size 1.5 mm<sup>2</sup></b>									
	With short-circuit release									
	1	A	<b>5SK9 011-1KK24</b>		1	10	027	0.053		
	2	A	<b>5SK9 011-1KK25</b>		1	10	027	0.052		
	4	B	<b>5SK9 011-1KK26</b>		1	10	027	0.053		
	6	A	<b>5SK9 011-1KK27</b>		1	10	027	0.053		
	10	B	<b>5SK9 011-1KK28</b>		1	10	027	0.050		
	With overload and short-circuit release									
	1	A	<b>5SK9 011-2KK24</b>		1	10	027	0.053		
	2	A	<b>5SK9 011-2KK25</b>		1	10	027	0.052		
4	A	<b>5SK9 011-2KK26</b>		1	10	027	0.053			
6	A	<b>5SK9 011-2KK27</b>		1	10	027	0.053			
10	B	<b>5SK9 011-2KK28</b>		1	10	027	0.050			
	<b>Terminal size 2.5 mm<sup>2</sup></b>									
	With short-circuit release, auxiliary switch with 1 NO and 1 NC									
	1	B	<b>5SK9 011-6KK24</b>		1	5	027	0.096		
	2	B	<b>5SK9 011-6KK25</b>		1	5	027	0.093		
	4	B	<b>5SK9 011-6KK26</b>		1	5	027	0.092		
	6	B	<b>5SK9 011-6KK27</b>		1	5	027	0.093		
	10	B	<b>5SK9 011-6KK28</b>		1	5	027	0.090		
	With overload and short-circuit release, auxiliary switch with 1 NC and through-type connection									
	1	B	<b>5SK9 011-4KK24</b>		1	5	027	0.089		
	2	A	<b>5SK9 011-4KK25</b>		1	5	027	0.092		
	4	A	<b>5SK9 011-4KK26</b>		1	5	027	0.091		
	6	B	<b>5SK9 011-4KK27</b>		1	5	027	0.105		
	10	B	<b>5SK9 011-4KK28</b>		1	5	027	0.088		
	With overload and short-circuit release, auxiliary switch with 1 NO and 1 NC									
	0.5	B	<b>5SK9 011-8KK23</b>		1	5	027	0.092		
	1	A	<b>5SK9 011-8KK24</b>		1	5	027	0.092		
	2	A	<b>5SK9 011-8KK25</b>		1	5	027	0.097		
	4	A	<b>5SK9 011-8KK26</b>		1	5	027	0.092		
6	A	<b>5SK9 011-8KK27</b>		1	5	027	0.090			
10	B	<b>5SK9 011-8KK28</b>		1	5	027	0.090			
	<b>Feeder terminals</b>									
	Rated uninterrupted current 76 A Connection up to 16 mm <sup>2</sup>		A	<b>5ST1 822-7KK00</b>		1	10	027	0.012	
		<b>Link rails, single-phase</b>		A	<b>5ST1 822-7KK02</b>		1	20	027	0.015
		Rated uninterrupted current 65 A								
5 connecting pins • Length 104 mm • For terminals: 5SK9 011-4KK2., 5SK9 011-6KK2., 5SK9 011-8KK2.										
	9 connecting pins • Length 104 mm • For terminals: 5SK9 011-1KK2., 5SK9 011-2KK2.		A	<b>5ST1 822-7KK07</b>		1	20	027	0.013	
	10 connecting pins • Length 206 mm • For terminals: 5SK9 011-4KK2., 5SK9 011-6KK2.		A	<b>5ST1 822-7KK01</b>		1	20	027	0.031	
	18 connecting pins • Length 206 mm • For terminals: 5SK9 011-1KK2., 5SK9 011-2KK2.		A	<b>5ST1 822-7KK06</b>		1	20	027	0.036	
	<b>Link rails, two-phase</b>									
	Rated uninterrupted current 120 A For terminal: 5SK9 011-4KK2.									
	5 connecting pins/pole • Length 104 mm		A	<b>5ST1 822-7KK04</b>		1	10	027	0.031	
	9 connecting pins/pole • Length 206 mm		A	<b>5ST1 822-7KK03</b>		1	10	027	0.061	

\* You can order this quantity or a multiple thereof.

# BETA Protecting Residual Current Protective Devices

## RCCBs, type A, 5SM3

### Overview

RCCBs of type A are used in all systems up to 240/415 V AC. They trip in the event of both sinusoidal AC residual currents and pulsating DC residual currents.

RCCBs with a rated residual current of maximum 30 mA are used for personnel, material and fire protection, as well as for additional protection against direct contact. RCCBs with a rated residual current of 10 mA are primarily used in areas that represent an increased risk for personnel.

Since the amendment of DIN VDE 0100-410 came into effect in June 2007, all socket outlet current circuits up to 20 A must now also be fitted with residual current protective devices with a rated residual current of max. 30 mA. This also applies to outdoor electrical circuits up to 32 A for the connection of portable equipment.

Devices with a rated residual current of maximum 300 mA are used as preventative fire protection in case of insulation faults. RCCBs with a rated residual current of 100 mA are primarily used outside Europe.

*Note:*  
DIN VDE 0100 is the German version of IEC 60364.

### SIGRES

SIGRES RCCBs were developed for use in harsh ambient conditions, such as swimming baths as protection against chlorine and ozone, in the agricultural sector (ammonia), on building sites and in the chemical industry (nitrogen oxide, sulfur dioxide, solvents), in the food processing industry (hydrogen sulfide) and in unheated rooms (dampness). The patented active condensation protection requires a permanent power supply and the in-feed from below with the RCCBs switched off.

For use under ambient conditions according to the product standard (EN 61008-1), the actuation interval for pressing the test button can be extended to once a year.

### Super resistant **K**

Super resistant (short-time delayed) RCCBs comply with the maximum permissible break times for instantaneous devices. However, by implementing a short-time delay they prevent unnecessary trippings, and thus plant faults, when pulse-shaped leakage currents occur - as is the case when capacitors are switched on.

### Selective **S**

Can be used as upstream group switch for selective tripping contrary to a downstream, instantaneous or super resistant RCCB.

### Benefits

- Instantaneous RCCBs with the N-connection on the left-hand side enable simple bus mounting with standard pin busbars with MCBs installed on the right-hand side
- Instantaneous RCCBs with the N connection on the right-hand side can be bus-mounted with MCBs using a special pin busbar
- Instantaneous devices have a surge current withstand capability with current waveform 8/20  $\mu$ s of more than 1 kA, super resistant of more than 3 kA and selective of more than 5 kA. This ensures safe operation
- SIGRES has an extremely long service life due to patented active condensation protection and the same dimensions for fast and simple exchange of already installed instantaneous RCCBs
- Super resistant devices increase plant availability, as unnecessary tripping is prevented in systems with short-time voltage peaks
- Selective RCCBs increase plant availability, as in the event of a fault, a staggered tripping time enables the selective tripping of RCCBs connected in series
- Auxiliary switches or remote controlled mechanisms are also available as additional components
- The operating handle and the test button can be locked by means of a handle locking device.

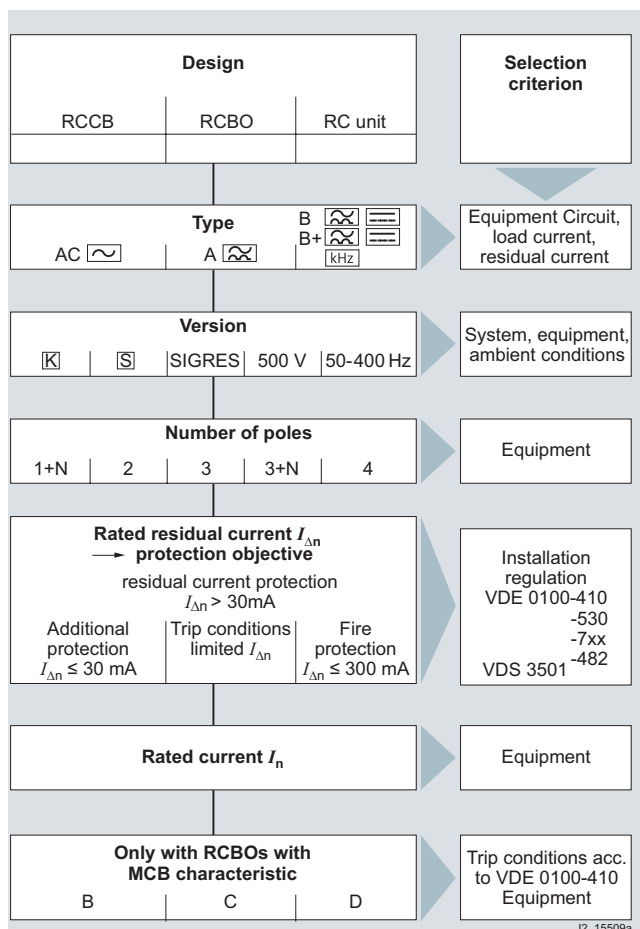





Selection aid for determining a suitable residual current protective device

# BETA Protecting Residual Current Protective Devices

## RCCBs, type A, 5SM3

### Selection and ordering data







	Rated residual current	Rated current	Max. permissible short-circuit back-up fuse	MW	DT	Order No.	Price per PU	PU	PS*	PG	Weight per PU approx.	
	$I_{\Delta n}$	$I_n$										
	mA	A	A					Unit(s)	Unit(s)		kg	
<b>RCCBs, type A instantaneous</b>												
1P+N; 125 ... 230 V AC; 50 ... 60 Hz												
N-connection, right												
	10	16	63	2	A	<b>5SM3 111-6</b>		1	1	007	0.230	
	30	16	63	2	A	<b>5SM3 311-6</b>		1	1	007	0.230	
		25				▶	<b>5SM3 312-6</b>		1	1	007	0.230
		40				▶	<b>5SM3 314-6</b>		1	1	007	0.230
	Up to 40 A	63	100	2.5	A	<b>5SM3 316-6</b>		1	1	007	0.320	
80				B	<b>5SM3 317-6</b>		1	1	007	0.320		
100			2	B	<b>5SM3 318-6KK</b>		1	1	007	0.245		
125				B	<b>5SM3 315-6KK</b>		1	1	007	0.245		
100			2	B	<b>5SM3 412-6</b>		1	1	007	0.230		
	63	100	2.5	B	<b>5SM3 414-6</b>		1	1	007	0.230		
		125		B	<b>5SM3 416-6</b>		1	1	007	0.300		
		80		B	<b>5SM3 417-6</b>		1	1	007	0.300		
	300	100	2	B	<b>5SM3 418-6KK</b>		1	1	007	0.245		
		125		B	<b>5SM3 415-6KK</b>		1	1	007	0.245		
63 A and 80 A	25	63	2	A	<b>5SM3 612-6</b>		1	1	007	0.210		
		100		A	<b>5SM3 614-6</b>		1	1	007	0.210		
	80	63	2.5	B	<b>5SM3 616-6</b>		1	1	007	0.280		
		100		B	<b>5SM3 617-6</b>		1	1	007	0.280		
		125		B	<b>5SM3 618-6KK</b>		1	1	007	0.245		
	125		B	<b>5SM3 615-6KK</b>		1	1	007	0.245			
N-connection, left												
	10	16	63	2	B	<b>5SM3 111-6KL</b>		1	1	007	0.280	
	30	16	63	2	B	<b>5SM3 311-6KL</b>		1	1	007	0.280	
		25				B	<b>5SM3 312-6KL</b>		1	1	007	0.280
		40				B	<b>5SM3 314-6KL</b>		1	1	007	0.280
	100 A and 125 A	63	100	2.5	B	<b>5SM3 316-6KL</b>		1	1	007	0.310	
100			2	B	<b>5SM3 414-6KL</b>		1	1	007	0.280		
125			2.5	B	<b>5SM3 416-6KL</b>		1	1	007	0.310		
300	25	63	2	B	<b>5SM3 612-6KL</b>		1	1	007	0.280		
		100		B	<b>5SM3 614-6KL</b>		1	1	007	0.280		
		125		B	<b>5SM3 616-6KL</b>		1	1	007	0.310		
<b>3P+N, 230 ... 400 V AC, 50 ... 60 Hz</b>												
N-connection, right												
	30	25	100	4	▶	<b>5SM3 342-6</b>		1	1	007	0.500	
		40				▶	<b>5SM3 344-6</b>		1	1	007	0.500
		63				▶	<b>5SM3 346-6</b>		1	1	007	0.500
	Up to 80 A	80	100		A	<b>5SM3 347-6</b>		1	1	007	0.500	
			125		▶	<b>5SM3 348-6</b>		1	1	007	0.538	
100	125	125		A	<b>5SM3 345-6</b>		1	1	007	0.500		
		100	4	A	<b>5SM3 444-6</b>		1	1	007	0.460		
	63	100		A	<b>5SM3 446-6</b>		1	1	007	0.460		
		100		▶	<b>5SM3 448-6</b>		1	1	007	0.538		
		125		▶	<b>5SM3 445-6</b>		1	1	007	0.480		
300	25	100	4	A	<b>5SM3 642-6</b>		1	1	007	0.440		
		40		A	<b>5SM3 644-6</b>		1	1	007	0.440		
		63		A	<b>5SM3 646-6</b>		1	1	007	0.440		
	80	100		A	<b>5SM3 647-6</b>		1	1	007	0.440		
		125		▶	<b>5SM3 648-6</b>		1	1	007	0.538		
100 A and 125 A	125	125		A	<b>5SM3 645-6</b>		1	1	007	0.480		
		100	4	B	<b>5SM3 742-6</b>		1	1	007	0.440		
		40		A	<b>5SM3 744-6</b>		1	1	007	0.440		
	63	100		A	<b>5SM3 746-6</b>		1	1	007	0.440		
		100		▶	<b>5SM3 748-6</b>		1	1	007	0.538		
	125		A	<b>5SM3 745-6</b>		1	1	007	0.480			

\* You can order this quantity or a multiple thereof.



# BETA Protecting Residual Current Protective Devices

## RCCBs, type A, 5SM3



	Rated residual current	Rated current	Max. permissible short-circuit back-up fuse	MW	DT	Order No.	Price per PU	PU	PS*	PG	Weight per PU approx.
	$I_{\Delta n}$ mA	$I_n$ A	 10.000 A					Unit(s)	Unit(s)		kg
<b>RCCBs, type A instantaneous</b>											
	3P+N; 230 ... 400 V AC; 50 ... 60 Hz										
	N-connection, left										
	30	25	100	4	B	<b>5SM3 342-6KL</b>		1	1	007	0.500
		40			▶ B	<b>5SM3 344-6KL</b>		1	1	007	0.500
		63			B	<b>5SM3 346-6KL</b>		1	1	007	0.500
		80			B	<b>5SM3 347-6KL</b>		1	1	007	0.500
	300	25	100	4	B	<b>5SM3 642-6KL</b>		1	1	007	0.440
		40			B	<b>5SM3 644-6KL</b>		1	1	007	0.440
		63			B	<b>5SM3 646-6KL</b>		1	1	007	0.440
		80			B	<b>5SM3 647-6KL</b>		1	1	007	0.440
	500	63	100	4	A	<b>5SM3 746-6KL</b>		1	1	007	0.460
	<b>RCCBs, type A instantaneous, special versions</b>										
	1P+N; 24 ... 125 V AC; 50 ... 60 Hz										
	30	16	63	2	B	<b>5SM3 311-6KK13</b>		1	1	007	0.280
	3P+N; 500 V AC; 50 ... 60 Hz										
	30	25	63	4	B	<b>5SM3 352-6</b>		1	1	007	0.500
		40			B	<b>5SM3 354-6</b>		1	1	007	0.500
		63			B	<b>5SM3 356-6</b>		1	1	007	0.500
	300	25	63	4	B	<b>5SM3 652-6</b>		1	1	007	0.440
		40			B	<b>5SM3 654-6</b>		1	1	007	0.440
	63			B	<b>5SM3 656-6</b>		1	1	007	0.440	
	3P+N; 230 ... 400 V AC; 50 ... 400 Hz										
	30	25	80	4	B	<b>5SM3 342-6KK03</b>		1	1	007	0.500
		40			B	<b>5SM3 344-6KK03</b>		1	1	007	0.500
<b>RCCBs, type A SIGRES instantaneous</b>											
	1P+N; 125 ... 230 V AC; 50 ... 60 Hz										
	30	25	63	2	B	<b>5SM3 312-6KK12</b>		1	1	007	0.230
		40			B	<b>5SM3 314-6KK12</b>		1	1	007	0.230
		63	100	2.5	B	<b>5SM3 316-6KK12</b>		1	1	007	0.320
		80			B	<b>5SM3 317-6KK12</b>		1	1	007	0.320
	3P+N; 230 ... 400 V AC; 50 ... 60 Hz										
	30	25	100	4	B	<b>5SM3 342-6KK12</b>		1	1	007	0.500
		40			B	<b>5SM3 344-6KK12</b>		1	1	007	0.500
		63			B	<b>5SM3 346-6KK12</b>		1	1	007	0.500
		80			B	<b>5SM3 347-6KK12</b>		1	1	007	0.500
	300	40	100	4	B	<b>5SM3 644-6KK12</b>		1	1	007	0.440
		63			B	<b>5SM3 646-6KK12</b>		1	1	007	0.440

\* You can order this quantity or a multiple thereof.

# BETA Protecting

## Residual Current Protective Devices

### RCCBs, type A, 5SM3

	Rated residual current	Rated current	Max. permissible short-circuit back-up fuse	MW	DT	Order No.	Price per PU	PU	PS*	PG	Weight per PU approx.
	$I_{\Delta n}$ mA	$I_n$ A	 10.000 A					Unit(s)	Unit(s)		kg
	<b>RCCBs, type A SIGRES selective [S]</b>										
	3P+N, 230 ... 400 V AC, 50 ... 60 Hz										
	300	63	100	4	B	<b>5SM3 646-8KK12</b>		1	1	007	0.440
	<b>RCCBs, type A Super resistant [K]</b>										
	1P+N; 125 ... 230 V AC; 50 ... 60 Hz										
	30	25	63	2	B	<b>5SM3 312-6KK01</b>		1	1	007	0.230
		40			B	<b>5SM3 314-6KK01</b>		1	1	007	0.230
		63	100	2.5	B	<b>5SM3 316-6KK01</b>		1	1	007	0.320
	300	63	100	2.5	B	<b>5SM3 616-6KK01</b>		1	1	007	0.320
	3P+N, 230 ... 400 V AC, 50 ... 60 Hz										
	30	25	100	4	B	<b>5SM3 342-6KK01</b>		1	1	007	0.500
		40			B	<b>5SM3 344-6KK01</b>		1	1	007	0.500
		63			B	<b>5SM3 346-6KK01</b>		1	1	007	0.500
	300	40	100	4	B	<b>5SM3 644-6KK01</b>		1	1	007	0.492
		63			B	<b>5SM3 646-6KK01</b>		1	1	007	0.491
		80			B	<b>5SM3 647-6KK01</b>		1	1	007	0.493
	<b>RCCBs, type A Selective [S]</b>										
	1P+N; 125 ... 230 V AC; 50 ... 60 Hz										
	100	63	100	2.5	B	<b>5SM3 416-8</b>		1	1	007	0.300
	300	40	63	2	B	<b>5SM3 614-8</b>		1	1	007	0.250
		63	100	2.5	A	<b>5SM3 616-8</b>		1	1	007	0.280
		80	100		B	<b>5SM3 617-8</b>		1	1	007	0.320
	3P+N, 230 ... 400 V AC, 50 ... 60 Hz										
	N-connection, right										
	100	40	100	4	B	<b>5SM3 444-8</b>		1	1	007	0.460
		63			B	<b>5SM3 446-8</b>		1	1	007	0.460
	300	40	100	4	A	<b>5SM3 644-8</b>		1	1	007	0.440
		63			A	<b>5SM3 646-8</b>		1	1	007	0.440
		100			B	<b>5SM3 648-8</b>		1	1	007	0.538
		125	125		A	<b>5SM3 645-8</b>		1	1	007	0.480
	500	125	125	4	B	<b>5SM3 745-8</b>		1	1	007	0.480
	1000	63	100	4	A	<b>5SM3 846-8</b>		1	1	007	0.515
	N-connection, left										
300	63	100	4	B	<b>5SM3 646-8KL</b>		1	1	007	0.440	

Up to 80 A

\* You can order this quantity or a multiple thereof.

# BETA Protecting Residual Current Protective Devices

SIQUENCE, universal current-sensitive RCCBs  
type B and type B+, 5SM3 and 5SU1

## Overview

Frequency converters, medical devices and UPS systems are seeing increasing use in industry. Smooth DC residual currents or currents with low residual ripple may occur in the event of faults on these devices.

Type A residual current protective devices are unable to detect these smooth DC residual currents. Furthermore, such smooth DC residual currents make Type A devices increasingly insensitive to AC residual currents and pulsating DC residual currents. Hence if a fault occurs, there is no tripping and the desired protection function is no longer assured.

UC-sensitive residual current protective devices of Types B and B+ have an additional transformer which is supplied with a control signal. Hence it is possible to evaluate the change of the transformer's operating range caused by smooth DC residual currents. The desired protection function is thus assured.

The residual current protective devices of Type B are suitable for use in three-phase current systems before input circuits with rectifiers. They are not intended for use in DC systems and in networks with operating frequencies other than 50 or 60 Hz.





The devices in this series are designed as residual current operated circuit breakers (RCCBs) up to 80 A and as residual current circuit breakers with integral overcurrent protection (RCBOs) for 100 A or 125 A in Characteristics C or D.

Type B+ residual current protective devices additionally offer enhanced, preventative fire protection. In these versions, the tripping value is limited to a maximum of 420 mA up to 20 kHz.

## Benefits

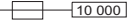
- Universal current-sensitive residual current protective devices detect not only AC residual currents and pulsating DC residual currents, but also smooth DC residual currents, thus ensuring the desired protective function with all types of residual current
- With type B, the tripping characteristic is adapted to the increase of leakage currents at higher frequencies in systems with capacitive impedances and results in increased operating safety.
- Type B+ versions offer enhanced preventative fire protection and correspond to the prestandards DIN V VDE V 0664-110 and/or DIN V VDE V 0664-210 and VdS Directive 3501.
- The RCBO is a compact device for up to 125 A. It provides not only personnel, property and fire protection but also overload and short-circuit protection for cables. This enables great savings on wiring and installation costs.
- All RCBOs offer external remote tripping over terminals Y1/Y2. This supports implementation of central OFF circuits

## Selection and ordering data







	Rated residual current	Rated current	Max. permissible short-circuit back-up fuse	MW	DT	Order No.	Price per PU	PU	PS*	PG	Weight per PU approx.
	$I_{\Delta n}$ mA	$I_n$ A	 10 000 A					Unit(s)	Unit(s)		kg
<b>SIQUENCE RCCBs, type B Super resistant <b>K</b></b>											
1P+N; 230 V AC; 50 ... 60 Hz											
	30	16	100	4	A	<b>5SM3 321-4</b>		1	1	015	0.590
		25				<b>5SM3 322-4</b>					
		40				<b>5SM3 324-4</b>					
		63				<b>5SM3 326-4</b>					
	300	16	100	4	A	<b>5SM3 621-4</b>		1	1	015	0.600
		25				<b>5SM3 622-4</b>					
		40				<b>5SM3 624-4</b>					
		63				<b>5SM3 626-4</b>					
3P+N, 230 ... 400 V AC, 50 ... 60 Hz											
	30	25	100	4	A	<b>5SM3 342-4</b>		1	1	015	0.600
		40				<b>5SM3 344-4</b>					
		63				<b>5SM3 346-4</b>					
		80				<b>5SM3 347-4</b>					
	300	25	100	4	▶	<b>5SM3 642-4</b>		1	1	015	0.520
		40				<b>5SM3 644-4</b>					
		63				<b>5SM3 646-4</b>					
		80				<b>5SM3 647-4</b>					
	500	63	100	4	B	<b>5SM3 746-4</b>		1	1	015	0.520
		80				<b>5SM3 747-4</b>					
<b>SIQUENCE RCCBs, type B Selective <b>S</b></b>											
3P+N, 230 ... 400 V AC, 50 ... 60 Hz											
	300	63	100	4	B	<b>5SM3 646-5</b>		1	1	015	0.520
		80				<b>5SM3 647-5</b>					
	500	63	100	4	B	<b>5SM3 746-5</b>		1	1	015	0.520
		80				<b>5SM3 747-5</b>					

\* You can order this quantity or a multiple thereof.

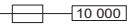
# BETA Protecting

## Residual Current Protective Devices

**SIQUENCE, universal current-sensitive RCCBs type B and type B+, 5SM3 and 5SU1**

	Rated residual current $I_{\Delta n}$ mA	Rated current $I_n$ A	Max. permissible short-circuit back-up fuse  10 000 A	MW	DT	Order No.	Price per PU	PU Unit(s)	PS* Unit(s)	PG	Weight per PU approx. kg
<b>SIQUENCE RCCBs, type B+ Super resistant [K]</b>											
	1P+N; 230 V AC; 50 ... 60 Hz										
	30	16	100	4	C	5SM3 321-4KK14		1	1	015	0.587
		25				5SM3 322-4KK14					
		40				5SM3 324-4KK14					
		63				5SM3 326-4KK14					
	300	16	100	4	C	5SM3 621-4KK14		1	1	015	0.600
		25				5SM3 622-4KK14					
		40				5SM3 624-4KK14					
63		5SM3 626-4KK14									
<b>SIQUENCE RCCBs, type B+ Selective [S]</b>											
	3P+N; 230 ... 400 V AC; 50 ... 60 Hz										
	30	25	100	4	C	5SM3 342-4KK14		1	1	015	0.600
		40				5SM3 344-4KK14					
		63				5SM3 346-4KK14					
		80				5SM3 347-4KK14					
	300	25	100	4	C	5SM3 642-4KK14		1	1	015	0.600
		40				5SM3 644-4KK14					
		63				5SM3 646-4KK14					
80		5SM3 647-4KK14									
<b>SIQUENCE RCCBs, type B+ Selective [S]</b>											
	3P+N; 230 ... 400 V AC; 50 ... 60 Hz										
	300	63	100	4	C	5SM3 646-5KK14		1	1	015	0.600
	80	5SM3 647-5KK14									
<b>SIQUENCE RCBOs, type B Super resistant [K], rated switching capacity 10 kA</b>											
	4P; 400 V AC; 50 ... 60 Hz										
	Characteristic C										
	30	100		11	B	5SU1 374-7AK81		1	1	017	2.050
		125				5SU1 374-7AK82					
	300	100		11	B	5SU1 674-7AK81		1	1	017	2.050
		125				5SU1 674-7AK82					
	Characteristic D										
	30	100		11	B	5SU1 374-8AK81		1	1	017	2.050
300	100		11	B	5SU1 674-8AK81		1	1	017	2.050	
<b>SIQUENCE RCBOs, type B Super resistant [K], rated switching capacity 10 kA</b>											
	4P; 480 V AC; 50 ... 60 Hz										
	Characteristic C										
	300	100		11	B	5SU1 674-7CK81		1	1	017	2.050
		125				5SU1 674-7CK82					
Characteristic D											
300	100		11	B	5SU1 674-8BK81		1	1	017	1.950	

# BETA Protecting Residual Current Protective Devices

SIQUENCE, universal current-sensitive RCCBs  
type B and type B+, 5SM3 and 5SU1

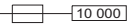
Rated residual current	Rated current	Max. permissible short-circuit back-up fuse	MW	DT	Order No.	Price per PU	PU	PS*	PG	Weight per PU approx.
$I_{\Delta n}$ mA	$I_n$ A	 10 000 A					Unit(s)	Unit(s)		kg
<b>SIQUENCE RCBs, type B+ Super resistant [K], rated switching capacity 10 kA</b>										
4P; 400 V AC; 50 ... 60 Hz										
Characteristic C										
30	100		11	C	<b>5SU1 374-7DK81</b>		1	1	017	2.067
	125			C	<b>5SU1 374-7DK82</b>		1	1	017	2.053
300	100		11	C	<b>5SU1 674-7DK81</b>		1	1	017	2.069
	125			C	<b>5SU1 674-7DK82</b>		1	1	017	2.088
Characteristic D										
30	100		11	C	<b>5SU1 374-8DK81</b>		1	1	017	2.084
300	100		11	C	<b>5SU1 674-8DK81</b>		1	1	017	2.082
4P; 480 V AC; 50 ... 60 Hz										
Characteristic C										
300	100		11	C	<b>5SU1 674-7FK81</b>		1	1	017	2.050
	125			C	<b>5SU1 674-7FK82</b>		1	1	017	2.050
<b>SIQUENCE RCBs, type B+ Selective [S], rated switching capacity 10 kA</b>										
4P; 400 V AC; 50 ... 60 Hz										
Characteristic C										
300	125		11	C	<b>5SU1 674-7EK82</b>		1	1	017	2.082
Characteristic D										
300	100		11	C	<b>5SU1 674-8EK81</b>		1	1	017	2.078

## More information

More information about SIQUENCE residual current protective devices, universal-current sensitive RCCBs type B and type B+, 5SM3 and 5SU1, can be found in Catalog ET B1 · 2010. You can download the up-to-date catalog from [www.siemens.com/e-installation-catalogs](http://www.siemens.com/e-installation-catalogs).

# BETA Protecting Residual Current Protective Devices

## Additional components

### Overview

Auxiliary switches (AS) signal the contact position of the RCCB.





Remote-controlled mechanisms are used for the remote ON/OFF switching of RCCBs. They also enable local manual switching. A blocking function permits maintenance work. If the RCCB is tripped, an acknowledgment must be carried out prior to switching back on.

The leakage current measurement device detects the leakage currents - like the circuit breaker - thus providing a direct statement as to the current loading of the RCCB. It is used to measure leakage currents up to 300 mA. This requires a voltmeter with an internal resistance more than 1 M $\Omega$ /V and a measuring range for AC voltages of  $U_{\text{eff}} = 1 \text{ mV}$  to 2 V. For the fault-free operation of an RCCB, the measured leakage current should be no greater than 1/3 of the rated residual current.

### Benefits

- Using captive brackets, the remote-controlled mechanism can be attached (or retrofitted) to the right-hand side of the basic device without the need for tools
- Bus systems, such as *instabus* KNX, AS-Interface bus or PROFIBUS, can be integrated in the communication over binary inputs
- The leakage current measurement device enables the systematic selection of the rated residual current, thus helping to prevent the inadvertent tripping of RCCBs.

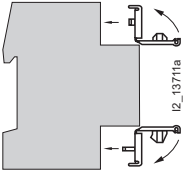

### Selection and ordering data

Version	MW	DT	Order No.	Price per PU	PU	PS*	PG	Weight per PU approx.
					Unit(s)	Unit(s)		kg
	<b>Auxiliary switches (AS) For 5SM3 RCCBs up to 80 A</b>							
	1 NO + 1 NC	0.5	▶	<b>5SW3 300</b>	1	1/10	008	0.042
	2 NC	0.5	C	<b>5SW3 301</b>	1	1/10	008	0.042
	2 NO	0.5	A	<b>5SW3 302</b>	1	1/10	008	0.042
	<b>Auxiliary switches (AS) For 5SM3 RCCBs, 100 ... 125 A, 3P+N</b>							
1 NO + 1 NC	0.5	B	<b>5SW3 330</b>	1	1	008	0.040	
	<b>Remote-controlled mechanisms (RC) For 5SM3 RCCBs up to 80 A</b>							
Rated voltage $U_n = 230 \text{ V AC}$	3.5	B	<b>5ST3 051</b>	1	1	027	0.395	
	<b>Leakage current measurement device</b>							
Rated voltage $U_n = 500 \text{ V AC}$ ; 50 ... 60 Hz, 4P	4	B	<b>5SM1 930-0</b>	1	1	008	0.430	
Rated residual current $I_{\Delta n} = 0 \dots 300 \text{ mA}$								
Rated current $I_n = 63 \text{ A}$								
	<b>Covers for connection terminals</b>							
	For residual current operated circuit breakers up to 80 A, sealable (2 units in plastic bag)							
	2	A	<b>5SW3 010</b>	1	1/50	008	0.003	
2.5	A	<b>5SW3 011</b>	1	1/50	008	0.004		
4	A	<b>5SW3 008</b>	1	1/50	008	0.006		

\* You can order this quantity or a multiple thereof.

# BETA Protecting Residual Current Protective Devices

Additional components  
RC units, type A, 5SM2

Version	MW	DT	Order No.	Price per PU	PU	PS*	PG	Weight per PU approx.
					Unit(s)	Unit(s)		kg
 <p><b>Locking devices</b> for RCCBs up to 80 A, sealable and lockable 4.5 mm hole diameter</p>		B	<b>5SW3 303</b>		1	10	008	0.008
 <p><b>Padlocks</b> For 5SW3 303 locking device</p>		▶	<b>5ST3 802</b>		1	1	027	0.027
<p><b>Locking devices with padlock</b> Comprising 5SW3 303 locking device and 5ST3 802 padlock</p>		B	<b>5SW3 312</b>		1 set	1 set	008	0.035

## More information

Gossen-Metrawatt offers suitable test devices for RCCB function tests and for testing protective measures.

Information is available at:

Gossen-Metrawatt GmbH  
Thomas-Mann-Str. 16-20  
D-90471 Nuremberg  
Germany

Tel. +49 (0) 9 11/86 02-111  
Fax +49 (0) 9 11/86 02-777

[www.gmc-instruments.com](http://www.gmc-instruments.com)

E-mail: [info@gmc-instruments.com](mailto:info@gmc-instruments.com)

## Overview

### RC units, type A, 5SM2

RC units of type A can be used in all systems up to 240/415 V AC. They trip in the event of both sinusoidal AC fault currents and pulsating DC residual currents.

RCCBs with a rated residual current of maximum 30 mA are used for personnel, material and fire protection, and for additional protection against direct contact.

Devices with a rated residual current of maximum 300 mA are used as preventative fire protection in case of insulation faults.

RC units are combined with MCBs with characteristics A, B, C and D, provided that these are available in the MCB range. The two components are simply plugged together without the need for any tools.

They then form a combination of RCCB and MCB for personnel, fire and line protection.

### Super resistant

Super resistant (short-time delayed) RC units satisfy the maximum permissible break times for instantaneous devices. However, by implementing a short-time delay they prevent unnecessary trippings, and thus plant faults, when pulse-shaped leakage currents occur - as is the case when capacitors are switched on.

### Selective

Can be used as upstream group switch for selective tripping contrary to a downstream, instantaneous or super resistant RCCB.

The dimensioning of the rated residual current depends on the size of the plant.

## Benefits

- Our wide variety of RC unit types and comprehensive range of miniature circuit breakers offer a huge spectrum of combinations for all applications
- All devices have an current withstand capability of more than 1 kA, thus ensuring safe and reliable operation
- All additional components for miniature circuit breakers can be retrofitted on the right-hand side
- All 100 A and 125 A RC units offer external remote tripping over terminals Y1/Y2. This supports implementation of central OFF circuits
- Both components can be simply plugged into each other and secured with captive metal brackets - no tools required. This saves considerable time when mounting.







\* You can order this quantity or a multiple thereof.

# BETA Protecting Residual Current Protective Devices

## RC units, type A, 5SM2

### Selection and ordering data





	Rated residual current	Rated current	MW	DT	Order No.	Price per PU	PU	PS*	PG	Weight per PU approx.
	$I_{\Delta n}$ mA	$I_n$ A					Unit(s)	Unit(s)		kg
<b>RC units, type A instantaneous</b>										
For 5SY miniature circuit breakers, but not for 5SY5 and 5SY6 0..										
2P, 230 ... 400 V AC, 50 ... 60 Hz										
	10	0.3 ... 16	2	B	<b>5SM2 121-6</b>		1	1	007	0.180
	30	0.3 ... 40		▶	<b>5SM2 322-6</b>		1	1	007	0.170
	300			A	<b>5SM2 622-6</b>		1	1	007	0.170
	30	0.3 ... 63		A	<b>5SM2 325-6</b>		1	1	007	0.170
	100			B	<b>5SM2 425-6</b>		1	1	007	0.170
	300			B	<b>5SM2 625-6</b>		1	1	007	0.170
500			B	<b>5SM2 725-6</b>		1	1	007	0.170	
<hr/>										
For 5SY miniature circuit breakers, but not for 5SY5 and 5SY6 0..										
3P, 230 ... 400 V AC, 50 ... 60 Hz										
	30	0.3 ... 40	3	A	<b>5SM2 332-6</b>		1	1	007	0.260
	300			A	<b>5SM2 632-6</b>		1	1	007	0.260
	30	0.3 ... 63		B	<b>5SM2 335-6</b>		1	1	007	0.260
	100			B	<b>5SM2 435-6</b>		1	1	007	0.260
	300			B	<b>5SM2 635-6</b>		1	1	007	0.260
	500			B	<b>5SM2 735-6</b>		1	1	007	0.260
<hr/>										
For 5SY miniature circuit breakers, but not for 5SY5 and 5SY6 0..										
4P, 230 ... 400 V AC, 50 ... 60 Hz										
	30	0.3 ... 40	3	▶	<b>5SM2 342-6</b>		1	1	007	0.290
	300			▶	<b>5SM2 642-6</b>		1	1	007	0.290
	30	0.3 ... 63		A	<b>5SM2 345-6</b>		1	1	007	0.290
	100			B	<b>5SM2 445-6</b>		1	1	007	0.290
	300			A	<b>5SM2 645-6</b>		1	1	007	0.290
	500			A	<b>5SM2 745-6</b>		1	1	007	0.290
<hr/>										
For 5SP4 miniature circuit breakers (B and C characteristic)										
2P; 125 ... 230 V AC, 50 ... 60 Hz										
	30	80 ... 100	3.5	B	<b>5SM2 327-6</b>		1	1	007	0.410
	300			B	<b>5SM2 627-6</b>		1	1	007	0.410
<hr/>										
For 5SP4 miniature circuit breakers (B and C characteristic)										
4P; 230 ... 400 V AC, 50 ... 60 Hz										
	30	80 ... 100	5	B	<b>5SM2 347-6</b>		1	1	007	0.630
	300			A	<b>5SM2 647-6</b>		1	1	007	0.630

\* You can order this quantity or a multiple thereof.



# BETA Protecting Residual Current Protective Devices

## RC units, type A, 5SM2

	Rated residual current	Rated current	MW	DT	Order No.	Price per PU	PU	PS*	PG	Weight per PU approx.	
	$I_{\Delta n}$ mA	$I_n$ A					Unit(s)	Unit(s)		kg	
	<b>RC units, type A Super resistant <b>K</b></b>										
	For 5SY miniature circuit breakers, but not for 5SY5 and 5SY6 0..										
	2P, 230 ... 400 V AC, 50 ... 60 Hz										
	30	0.3 ... 40	2	B	<b>5SM2 322-6KK01</b>		1	1	007	0.350	
	30	0.3 ... 63		B	<b>5SM2 325-6KK01</b>		1	1	007	0.350	
	3P, 230 ... 400 V AC, 50 ... 60 Hz										
	30	0.3 ... 40	3	B	<b>5SM2 332-6KK01</b>		1	1	007	0.365	
	30	0.3 ... 63		B	<b>5SM2 335-6KK01</b>		1	1	007	0.365	
	<b>RC units, type A Selective <b>S</b></b>										
	For 5SY miniature circuit breakers, but not for 5SY5 and 5SY6 0..										
	2P, 230 ... 400 V AC, 50 ... 60 Hz										
	300	0.3 ... 40	2	A	<b>5SM2 622-8</b>		1	1	007	0.170	
	300	0.3 ... 63		B	<b>5SM2 625-8</b>		1	1	007	0.170	
	3P, 230 ... 400 V AC, 50 ... 60 Hz										
	1000	0.3 ... 40	3	B	<b>5SM2 832-8</b>		1	1	007	0.365	
	300	0.3 ... 63	3	B	<b>5SM2 635-8</b>		1	1	007	0.260	
500			B	<b>5SM2 735-8</b>		1	1	007	0.400		
1000			B	<b>5SM2 835-8</b>		1	1	007	0.260		
	For 5SY miniature circuit breakers, but not for 5SY5 and 5SY6 0..										
	4P, 230 ... 400 V AC, 50 ... 60 Hz										
	300	0.3 ... 63	3	A	<b>5SM2 645-8</b>		1	1	007	0.290	
	500			A	<b>5SM2 745-8</b>		1	1	007	0.400	
1000			A	<b>5SM2 845-8</b>		1	1	007	0.290		
	For 5SP4 miniature circuit breakers (B and C characteristic)										
	2P; 125 ... 230 V AC, 50 ... 60 Hz										
300	80 ... 100	3.5	B	<b>5SM2 627-8</b>		1	1	007	0.410		
	For 5SP4 miniature circuit breakers (B and C characteristic)										
	4P; 230 ... 400 V AC, 50 ... 60 Hz										
	300	80 ... 100	5	A	<b>5SM2 647-8</b>		1	1	007	0.630	
1000			A	<b>5SM2 847-8</b>		1	1	007	0.630		

\* You can order this quantity or a multiple thereof.

# BETA Protecting Residual Current Protective Devices

## RCBOs, type A, 5SU1

### Overview

RCBOs are a combination of an RCCB and a miniature circuit breaker in a compact design for personnel, fire and line protection. For personnel and fire protection, the residual current part of the type A trips in the event of sinusoidal AC residual currents and pulsating DC residual currents.

RCBOs with a rated residual current of maximum 30 mA are used for personnel, material and fire protection, as well as for protection against direct contact. RCBOs with a rated residual current of 10 mA are primarily used in areas that represent an increased risk for personnel and the outdoor installations of residential buildings.

Devices with a rated residual current of maximum 300 mA are used as preventative fire protection in case of insulation faults.

The MCB part of the RCBO protects lines against overload and short circuits and is available in characteristics B and C.

Since the amendment of DIN VDE 0100-410 came into effect in June 2007, all socket outlet current circuits up to 20 A must now also be fitted with residual current protective devices with a rated residual current of max. 30 mA. This also applies to outdoor electrical circuits up to 32 A for the connection of portable equipment.

In order to implement this protection, we recommend the national use of RCBOs with 30 mA.

*Note:*  
*DIN VDE 0100 is the German version of IEC 60364.*

Assignment to each individual branch circuit helps prevent the unwanted tripping of fault-free circuits induced by the accumulation of operation-related leakage currents or by transient current pulses during switching operations.

RCBOs comprise one part for fault-current detection and one part for overcurrent detection. They are equipped with a delayed overload/time-dependent thermal release (thermal bimetal) for low overcurrents and with an instantaneous electromagnetic release for higher overload and short-circuit currents.

The special contact materials used guarantee a long service life and offer a high degree of protection against contact welding.

Additional components of the 5SY miniature circuit breakers can be mounted at the side and carry out additional functions.

For further details on additional components, please refer to "Miniature circuit breakers".

### Benefits

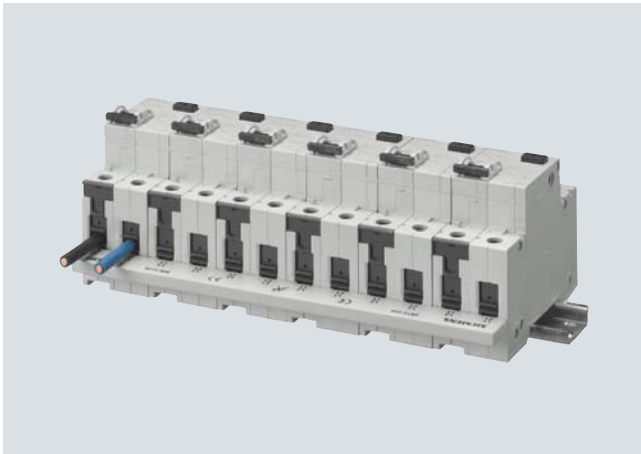

#### For all versions

- Clear and visible conductor connection that can be easily checked in front of the busbar.
- Large and easily accessible wiring space enables easy insertion of conductor in the terminals.
- The surge current withstand capability of more than 1 kA ensures safe and reliable operation
- All additional components for miniature circuit breakers can be retrofitted on the right-hand side.

#### For all 10 kA versions up to 40 A

- Integrated movable terminal covers located at the cable entries ensure the terminals are fully insulated when the screws are tightened. The effective touch protection when grasping the device considerably exceeds the requirements of BGV A3.
- The RCBOs can be quickly and easily removed from the assembly by hand if connections need to be changed. This saves time if parts need to be replaced because the busbars no longer need to be freed from the adjacent miniature circuit breakers.



#### For all 125 A versions

- The RCBOs offer external remote tripping over terminals Y1/Y2. This supports implementation of central OFF circuits.

# BETA Protecting Residual Current Protective Devices

RCBOs, type A, 5SU1

## Selection and ordering data







Rated residual current $I_{\Delta n}$ mA	Rated current $I_n$ A	MW	DT	Tripping characteristic B				Tripping characteristic C				PU	PS*	PG	Weight per PU approx. kg	
				Order No.	Price per PU	PG	DT	Order No.	Price per PU	PU	PS*					PG
<b>RCBOs, type A</b>																
<b>Instantaneous</b>																
1P+N; 230 V AC; 50 ... 60 Hz																
6 000																
3																
30	6	2	A	5SU1 356-6KK06		011	A	5SU1 356-7KK06		1	1	011	0.260			
	8			--			B	5SU1 356-7KK08		1	1	011	0.260			
	10		A	5SU1 356-6KK10		011	▶	5SU1 356-7KK10		1	1	011	0.260			
	13		B	5SU1 356-6KK13		011	A	5SU1 356-7KK13		1	1	011	0.260			
	16		▶	5SU1 356-6KK16		011	▶	5SU1 356-7KK16		1	1	011	0.260			
	20		B	5SU1 356-6KK20		011	B	5SU1 356-7KK20		1	1	011	0.260			
	25		B	5SU1 356-6KK25		011	A	5SU1 356-7KK25		1	1	011	0.260			
	32		B	5SU1 356-6KK32		011	B	5SU1 356-7KK32		1	1	011	0.260			
	40		B	5SU1 356-6KK40		011	B	5SU1 356-7KK40		1	1	011	0.260			
300	6	2	B	5SU1 656-6KK06		011	B	5SU1 656-7KK06		1	1	011	0.260			
	10		B	5SU1 656-6KK10		011	A	5SU1 656-7KK10		1	1	011	0.260			
	13		B	5SU1 656-6KK13		011	B	5SU1 656-7KK13		1	1	011	0.260			
	16		B	5SU1 656-6KK16		011	A	5SU1 656-7KK16		1	1	011	0.260			
	20		B	5SU1 656-6KK20		011	B	5SU1 656-7KK20		1	1	011	0.260			
	25		B	5SU1 656-6KK25		011	B	5SU1 656-7KK25		1	1	011	0.260			
	32		B	5SU1 656-6KK32		011	B	5SU1 656-7KK32		1	1	011	0.260			
	40		B	5SU1 656-6KK40		011	B	5SU1 656-7KK40		1	1	011	0.260			
<b>RCBOs, type A</b>																
<b>Instantaneous</b>																
1P+N; 230 V AC; 50 ... 60 Hz																
10 000																
3																
10	6	2	B	5SU1 154-6KK06		011	B	5SU1 154-7KK06		1	1	011	0.260			
	10		B	5SU1 154-6KK10		011	B	5SU1 154-7KK10		1	1	011	0.260			
	13		B	5SU1 154-6KK13		011	B	5SU1 154-7KK13		1	1	011	0.260			
	16		B	5SU1 154-6KK16		011	▶	5SU1 154-7KK16		1	1	011	0.260			
30	6	2	B	5SU1 354-6KK06		011	▶	5SU1 354-7KK06		1	1	011	0.260			
	8			--			B	5SU1 354-7KK08		1	1	011	0.260			
	10		B	5SU1 354-6KK10		011	▶	5SU1 354-7KK10		1	1	011	0.260			
	13		B	5SU1 354-6KK13		011	B	5SU1 354-7KK13		1	1	011	0.260			
	16		▶	5SU1 354-6KK16		011	▶	5SU1 354-7KK16		1	1	011	0.260			
	20		B	5SU1 354-6KK20		011	B	5SU1 354-7KK20		1	1	011	0.260			
	25		B	5SU1 354-6KK25		011	B	5SU1 354-7KK25		1	1	011	0.260			
	32		B	5SU1 354-6KK32		011	B	5SU1 354-7KK32		1	1	011	0.260			
	40		B	5SU1 354-6KK40		011	B	5SU1 354-7KK40		1	1	011	0.260			
300	6	2	B	5SU1 654-6KK06		011	B	5SU1 654-7KK06		1	1	011	0.260			
	10		B	5SU1 654-6KK10		011	B	5SU1 654-7KK10		1	1	011	0.260			
	13		B	5SU1 654-6KK13		011	B	5SU1 654-7KK13		1	1	011	0.260			
	16		B	5SU1 654-6KK16		011	B	5SU1 654-7KK16		1	1	011	0.260			
	20		B	5SU1 654-6KK20		011	B	5SU1 654-7KK20		1	1	011	0.260			
	25		B	5SU1 654-6KK25		011	B	5SU1 654-7KK25		1	1	011	0.260			
	32		B	5SU1 654-6KK32		011	B	5SU1 654-7KK32		1	1	011	0.260			
	40		B	5SU1 654-6KK40		011	B	5SU1 654-7KK40		1	1	011	0.260			
<b>RCBOs, type A</b>																
<b>Instantaneous</b>																
2P; 230 V AC; 50 ... 60 Hz																
10 000																
3																
30	6	3	B	5SU1 324-6FA06		011	B	5SU1 324-7FA06		1	1	011	0.403			
	10		▶	5SU1 324-6FA10		011	▶	5SU1 324-7FA10		1	1	011	0.403			
	13		B	5SU1 324-6FA13		011	B	5SU1 324-7FA13		1	1	011	0.403			
	16		▶	5SU1 324-6FA16		011	▶	5SU1 324-7FA16		1	1	011	0.403			
	20		B	5SU1 324-6FA20		011	B	5SU1 324-7FA20		1	1	011	0.403			
	25		B	5SU1 324-6FA25		011	B	5SU1 324-7FA25		1	1	011	0.403			
	32		B	5SU1 324-6FA32		011	B	5SU1 324-7FA32		1	1	011	0.403			
	40		B	5SU1 324-6FA40		011	B	5SU1 324-7FA40		1	1	011	0.403			

\* You can order this quantity or a multiple thereof.

# BETA Protecting

## Residual Current Protective Devices

### RCBOs, type A, 5SU1

	Rated residual current $I_{\Delta n}$ mA	Rated current $I_n$ A	MW	DT	Tripping characteristic B		Tripping characteristic C		PU Unit(s)	PS* Unit(s)	PG	Weight per PU approx. kg
					Order No.	Price per PU	Order No.	Price per PU				
<b>RCBOs, type A Instantaneous</b>												
	2P; 400 V AC; 50 ... 60 Hz											
	10 000											
	30	125	6.5	B	<b>5SU1 324-6KK82</b>		011 B	<b>5SU1 324-7KK82</b>	1	1	011	0.930
	300	125		B	<b>5SU1 624-6KK82</b>		011 B	<b>5SU1 624-7KK82</b>	1	1	011	0.930
	4P; 400 V AC; 50 ... 60 Hz											
	10 000											
	30	125	11	B	<b>5SU1 344-6KK82</b>		011 B	<b>5SU1 344-7KK82</b>	1	1	011	1.900
	300	125		B	<b>5SU1 644-6KK82</b>		011 B	<b>5SU1 644-7KK82</b>	1	1	011	1.900
<b>RCBOs, type A Super resistant [K]</b>												
	1P+N; 230 V AC; 50 ... 60 Hz											
	10 000											
	3											
	30	10	2	--			B	<b>5SU1 354-7VK10</b>	1	1	011	0.260
			16	--			B	<b>5SU1 354-7VK16</b>	1	1	011	0.260
		20	--			B	<b>5SU1 354-7VK20</b>	1	1	011	0.260	
		25	--			B	<b>5SU1 354-7VK25</b>	1	1	011	0.260	
<b>RCBOs, type A Selective [S]</b>												
	2P; 400 V AC; 50 ... 60 Hz											
	10 000											
	300	125	6.5	B	<b>5SU1 624-6WK82</b>		011 B	<b>5SU1 624-7WK82</b>	1	1	011	0.930
	4P; 400 V AC; 50 ... 60 Hz											
	10 000											
	300	125	11	B	<b>5SU1 644-6WK82</b>		011 B	<b>5SU1 644-7WK82</b>	1	1	011	1.900
Version					DT		Order No.	Price per PU	PU Unit(s)	PS* Unit(s)	PG	Weight per PU approx. kg
							<b>5ST3 805-1</b>		1 set	1 set	027	0.008
<b>Handle couplers for additional components</b>												
For mounting the additional components: auxiliary switches, fault signal contacts, shunt trips and undervoltage releases onto 5SU1 RCBOs, you require a handle coupler (1 set = 5 units).												

#### Note:

The same additional components are used for RCBOs as for miniature circuit breakers. See "Miniature circuit breakers".

#### More information

More information about RCBOs, type A, 5SU1 can be found in Catalog ET B1 · 2010.

The current issue of the catalog can be downloaded from [www.siemens.com/e-installation-catalogs](http://www.siemens.com/e-installation-catalogs).

\* You can order this quantity or a multiple thereof.

# BETA Protecting Residual Current Protective Devices

## Busbars

### Overview

4-pole 5SM3 RCCBs are bus-mounted either together or in combination with miniature circuit breakers. RCCBs with an N conductor connection on the left-hand side facilitate installation because normal busbars are used, as for miniature circuit breakers.

Busbars are available in 10 mm<sup>2</sup> and 16 mm<sup>2</sup>.

The extremely flexible 5ST3 6 busbar system with fixed lengths enables installation in any length as the busbars can be overlapped.

No further need for time-consuming tasks, such as cutting, cutting to length, deburring, cleaning of cut surfaces and mounting of end caps.

Any free pins on the busbars can be made finger-safe by covering with touch protection.

If several RCBOs are bus-mounted together, this is implemented with two-phase busbars, which are used as 1+N busbars.

### Benefits

- Connection of miniature circuit breakers to 4-pole RCCBs with N-connection right with three-phase busbar, using busbar specially designed for this application. No cutting or end caps required.
- Connection of miniature circuit breakers to 4-pole RCCBs with N-connection left with three-phase busbar that can be cut. No additional items to be stored and busbars that are always available.

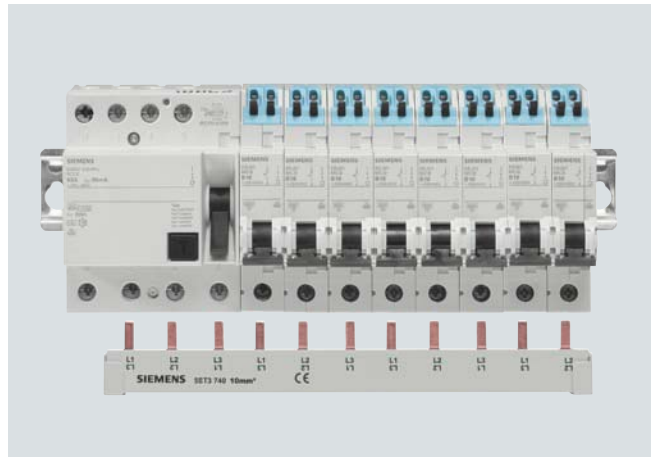
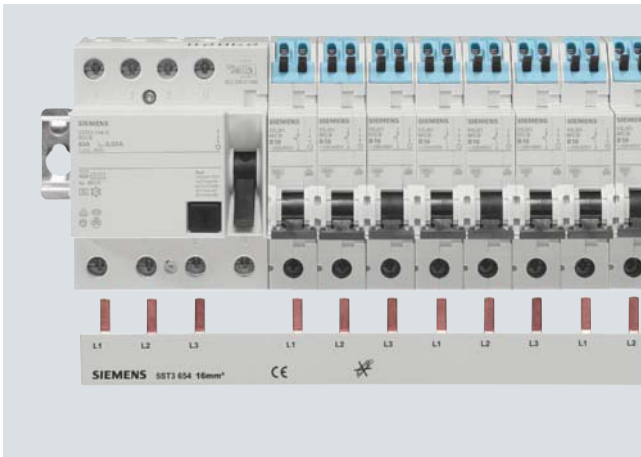



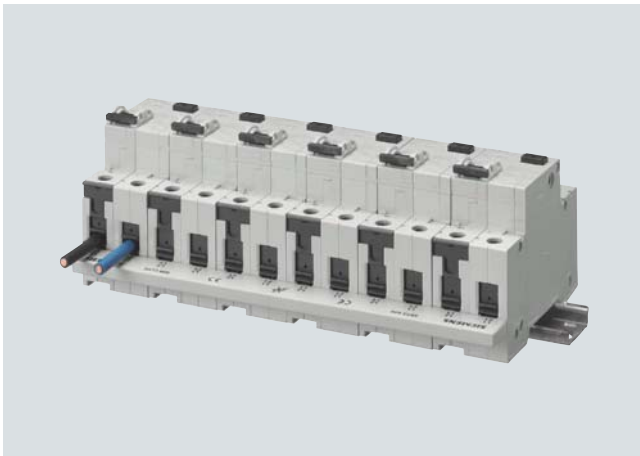

- Connection of 1P+N RCBOs with two-phase busbar. No cutting or end caps required.
- Bus mounting of RCCBs on busbar (three-phase +N) that can be cut. A proven and frequently used application

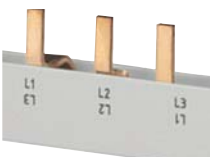

# BETA Protecting Residual Current Protective Devices

## Busbars

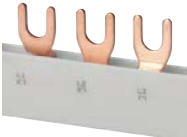
### Selection and ordering data







Version	Pin spacing	Length	DT	Order No.	Price per PU	PU	PS*	PG	Weight per PU approx.
	MW	mm				Unit(s)	Unit(s)		kg
<b>5ST3 6 busbar systems, fixed lengths, cannot be cut, fully insulated</b> For 1 RC block 4P, N connection right, and 8 MCBs 1P									
	• Three-phase 10 mm <sup>2</sup>	1	210	A	<b>5ST3 624</b>	1	10	027	0.075
	• Three-phase 16 mm <sup>2</sup>	1	210	A	<b>5ST3 654</b>	1	10	027	0.114
	For 6 RCBOs 1P+N together								
	• Two-phase 10 mm <sup>2</sup>		210	A	<b>5ST3 608</b>	1	10	027	0.048
• Two-phase 16 mm <sup>2</sup>		210	A	<b>5ST3 638</b>	1	10	027	0.076	
<b>5ST3 7 busbar systems, 12 MW, can be cut, with end caps</b> For 1 RC block 4P, N connection right, and 8 MCBs 1P									
	• Three-phase 16 mm <sup>2</sup>			A	<b>5ST3 717</b>	1	25	027	0.150
	For 6 RCBOs 1P+N								
	• Two-phase 10 mm <sup>2</sup>	1	216	A	<b>5ST3 734</b>	1	1	027	0.060
• Two-phase 16 mm <sup>2</sup>	1	216	A	<b>5ST3 704</b>	1	1	027	0.060	
<b>5ST3 7 busbar systems, with end caps, can be cut, finger-safe</b> For RCBO 1P+N and MCB 2P									
	• Four-phase 10 mm <sup>4</sup>	1	1008	A	<b>5ST3 770-2</b>	1	10	027	0.400
	• Four-phase 16 mm <sup>4</sup>	1	1008	A	<b>5ST3 770-3</b>	1	10	027	0.550
	For RC block 4P, N connection right and 6 MCBs 1P+N								
	• Four-phase 10 mm <sup>4</sup>	1	288	A	<b>5ST3 770-4</b>	1	10	027	0.100
• Four-phase 16 mm <sup>4</sup>	1	288	A	<b>5ST3 770-5</b>	1	10	027	0.160	
<b>End caps for 5ST3 7, can be cut</b> For two-phase busbars									
				▶	<b>5ST3 750</b>	1	10	027	0.001
<b>Touch protection</b> For free connections, yellow (RAL 1004) 5 x 1 pin									
				A	<b>5ST3 655</b>	1	10	027	0.003
<b>Busbars, 12 MW, with fork-type connections, can be cut, with end caps</b> For bus mounting RCCBs together									
	• Three-phase + N, 16 mm <sup>2</sup>	1	216	A	<b>5ST2 145</b>	1	1	027	0.315
<b>End caps for 5ST3 7, can be cut</b> For three-phase busbars									
				A	<b>5ST2 156</b>	1	10	027	0.017
<b>Terminals up to 35 mm<sup>2</sup> (stranded), for direct infeed of 5ST2 145 busbar</b> Side-by-side mounting possible									
				A	<b>5ST2 157</b>	1	5	027	0.030

\* You can order this quantity or a multiple thereof.

# BETA Protecting Residual Current Protective Devices

## Accessories

### Accessories

Version	DT	Order No.	Price per PU	PU	PS*	PG	Weight per PU approx.
				Unit(s)	Unit(s)		kg
 <p><b>Terminal covers, gray</b> For surface mounting, degree of protection IP40, sealable, with TH 35 standard mounting rail</p> <ul style="list-style-type: none"> <li>• Up to 2.5 MW</li> <li>• Up to 4.5 MW</li> </ul>	B	<b>5SW3 004</b>		1	1	008	0.084
	B	<b>5SW3 005</b>		1	1	008	0.114
 <p><b>Wall enclosures, gray</b> For flush mounting, degree of protection, IP40, with TH 35 standard mounting rail</p> <ul style="list-style-type: none"> <li>• Up to 2.5 MW</li> <li>• Up to 4.5 MW</li> </ul>	B	<b>5SW3 006</b>		1	1/4	008	0.126
	B	<b>5SW3 007</b>		1	1	008	0.147
 <p><b>Molded-plastic enclosures, gray</b> For surface mounting, degree of protection IP54, sealable, with TH 35 standard mounting rail, with transparent hinged lid For 4.5 MW</p>	A	<b>5SW1 200</b>		1	1	008	0.450
 <p><b>Covers</b> Can be assembled as mini distribution board, suitable for all devices, cover parts prepared for rail mounting of conventional label caps, comprising:</p> <ul style="list-style-type: none"> <li>• End plates (can be snapped onto standard mounting rail)</li> <li>• Angle section (approx. 1 m long)</li> <li>• Alternatively flat profile (as a cover between the rows of devices, length approx. 1 m)</li> </ul>	A	<b>5ST2 134</b>		1	10	027	0.022
	A	<b>5ST2 135</b>		1	5	027	0.330
	B	<b>5ST2 136</b>		1	5	027	0.260
 <p><b>Fixing parts</b> Plastic 4 MW</p>	B	<b>5ST2 201</b>		1	1	027	0.012
 <p><b>Inscription labels (white)</b> 15 mm x 9 mm, 3 frames à 44 labels, any attachment and inscription, self-adhesive</p>	B	<b>5ST2 173</b>		1 set	1 set	027	0.038

#### Labeling systems

Inscriptions on self-adhesive labels for a neat and uniform appearance in the power distribution system. The labeling program can be downloaded to your PC free of charge:

[www.siemens.com/beta](http://www.siemens.com/beta)

Recommended ELAT-3-747 labels for printing out on standard printers can be ordered from BRADY:

[www.bradycorp.com](http://www.bradycorp.com)

# BETA Protecting Low-Voltage Fuse Systems

## NEOZED fuse systems

### Overview

The NEOZED fuse system is primarily used in distribution technology and industrial switchgear assemblies. The system is easy to use and is also approved for domestic installation.

MINIZED switch disconnectors are primarily used in switchgear assemblies and control engineering. They are approved for switching loads and also for safe switching in the event of short circuits. The MINIZED D02 is also suitable for use in the pre-counter sector in household applications in compliance with the recommendations of the BDEW (association of German utilities) according to TAB 2007.

Due to its small footprint, the NEOZED disconnecter is primarily used in control engineering.

The NEOZED fuse bases are the most cost-effective solution for the application of NEOZED fuses. All NEOZED bases must be fed from the bottom to ensure that the threaded ring is insulated during removal of the fuse link. The terminals of the NEOZED bases are available in different versions and designs to support the various installation methods.

### Benefits



#### MINIZED switch disconnectors

- Clear and visible conductor connection that can be easily checked. This facilitates insertion of the conductor and saves time
- With draw-out technology for off-circuit replacement of fuses. This provides enhanced safety
- The infeed of the devices can be from the top or the bottom. This enables flexible application.

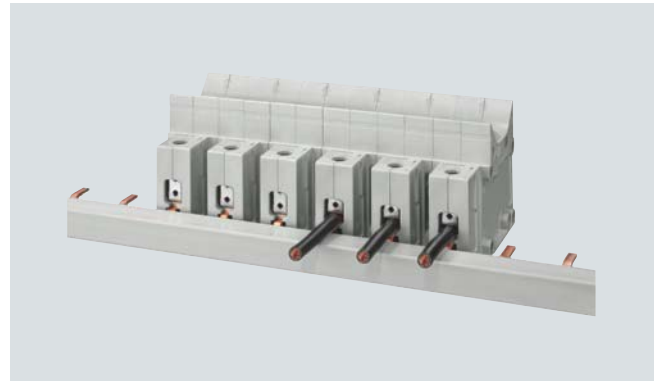

#### NEOZED fuse bases made of molded plastic

- Clear and visible conductor connection that can be easily checked. This facilitates insertion of the conductor and saves time
- Greater safety for personnel thanks to terminals with touch protection acc. to BGV A3 (labor safety specification) at incoming and outgoing feeder. This ensures enhanced safety
- Two type ranges with different terminals offer expanded application options.

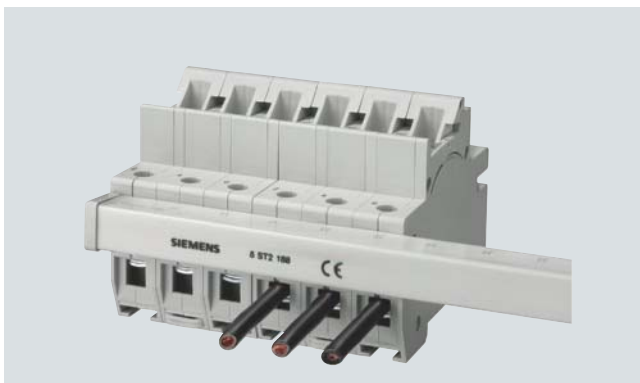

#### NEOZED fuse disconnectors

- With draw-out technology for off-circuit replacement of fuses. This provides enhanced safety
- Extremely narrow design with a single MW per pole. This saves space and costs.











#### NEOZED fuse bases made of ceramic

- Different terminal versions support a huge range of different installation methods. This ensures greater flexibility
- These bases are the most widely used devices for applications with NEOZED fuses. An unrivaled cost-effective solution.







## Selection and ordering data

	Size	Number of poles	$I_n$	Identification color	MW	DT	Order No.	Price per PU	PU	PS*	PG	Weight per PU approx.
			A						Unit(s)	Unit(s)		kg
<b>NEOZED fuse links</b> Rated voltage 400 V AC/250 V DC operational class gG												
	D01	2		Pink		▶	<b>5SE2 302</b>		1	10	016	0.006
		4		Brown		▶	<b>5SE2 304</b>		1	10	016	0.006
		6		Green		▶	<b>5SE2 306</b>		1	10/500	016	0.006
		10		Red		▶	<b>5SE2 310</b>		1	10/500	016	0.007
		13		Black	A	▶	<b>5SE2 013-2A</b>		1	10	016	0.007
		16		Gray		▶	<b>5SE2 316</b>		1	10/500	016	0.007
	D02	20		Blue		▶	<b>5SE2 320</b>		1	10	016	0.012
		25		Yellow		▶	<b>5SE2 325</b>		1	10	016	0.013
		32		Black	B	▶	<b>5SE2 332</b>		1	10	016	0.014
		35		Black		▶	<b>5SE2 335</b>		1	10	016	0.014
		40		Black	B	▶	<b>5SE2 340</b>		1	10	016	0.014
		50		White		▶	<b>5SE2 350</b>		1	10	016	0.015
		63		Copper		▶	<b>5SE2 363</b>		1	10	016	0.016
	D03	80		Blue		▶	<b>5SE2 280</b>		1	10	016	0.039
		100		Red		▶	<b>5SE2 300</b>		1	10	016	0.042
<b>MINIZED switch disconnectors with fuses</b> Using draw-out technology with touch protection to BGV A3 (adapter sleeves are not included in the scope of supply)												
	D02	1P	63		1.5	▶	<b>5SG7 113</b>		1	1	016	0.145
		1P+N	63		3	B	<b>5SG7 153</b>		1	1	016	0.267
		2P	63		3	B	<b>5SG7 123</b>		1	1	016	0.283
		3P	63		4.5	▶	<b>5SG7 133</b>		1	1	016	0.421
		3P+N	63		6	B	<b>5SG7 163</b>		1	1	016	0.540
		Versions for Austria only, permanently fitted adapter sleeves, including fuse link										
D02	3P	25			4.5	B	<b>5SG7 133-8BA25</b>		1	1	016	0.420
		35				B	<b>5SG7 133-8BA35</b>		1	1	016	0.420
		50				B	<b>5SG7 133-8BA50</b>		1	1	016	0.420
<b>Locking caps</b> In MINIZED D02 switch disconnectors for applications in the precounter sector												
						C	<b>5SH5 532</b>		1	1	016	0.012
<b>Reducers</b> For fuse links D01, in MINIZED switch disconnectors D02												
						C	<b>5SH5 527</b>		1	10/100	016	0.003
<b>Auxiliary switches (AS)</b> For MINIZED switch disconnectors D02												
		1 NO + 1 NC			0.5	▶	<b>5ST3 010</b>		1	1	027	0.050
		2 NO				A	<b>5ST3 011</b>		1	1	027	0.050
		2 NC				A	<b>5ST3 012</b>		1	1	027	0.050
		<a href="#">For technical specifications, see chapter Miniature circuit breakers -&gt; Additional components</a>										
<b>Auxiliary switches (AS) with TEST button</b> For MINIZED switch disconnectors D02												
		1 NO + 1 NC			0.5	A	<b>5ST3 010-2</b>		1	1	027	0.045
		2 NO				A	<b>5ST3 011-2</b>		1	1	027	0.045
		2 NC				A	<b>5ST3 012-2</b>		1	1	027	0.045
		<a href="#">For technical specifications, see chapter Miniature circuit breakers -&gt; Additional components</a>										

\* You can order this quantity or a multiple thereof.











# BETA Protecting Low-Voltage Fuse Systems

## NEOZED fuse systems

	Size	Number of poles	$I_n$	Matching cover <sup>1)</sup>	MW	DT	Order No.	Price per PU	PU	PS*	PG	Weight per PU approx.
			A						Unit(s)	Unit(s)		kg
<b>MINIZED fuse switch disconnectors</b>												
For industrial applications Using draw-out technology with touch protection BGV A3 (NEOZED adapter sleeves cannot be used)												
	D01	1P	16		1	A	<b>5SG7 610</b>		1	1	016	0.070
		1P+N	16		2	B	<b>5SG7 650</b>		1	1	016	0.150
		2P	16		2	B	<b>5SG7 620</b>		1	1	016	0.150
		3P	16		3	A	<b>5SG7 630</b>		1	1	016	0.220
		3P+N	16		4	B	<b>5SG7 660</b>		1	1	016	0.300
<b>NEOZED comfort bases made of molded plastic</b>												
With touch protection acc. to BGV A3												
	D01	1P	16	--	1.5	▶	<b>5SG1 301</b>		1	3	016	0.123
	D02		63	--		▶	<b>5SG1 701</b>		1	3	016	0.120
	D01	3P	16	--	4.5	▶	<b>5SG5 301</b>		1	1	016	0.371
	D02		63	--		▶	<b>5SG5 701</b>		1	1	016	0.360
<b>NEOZED fuse bases made of molded plastic</b>												
With touch protection acc. to BGV A3												
With cover												
	D01	1P	16	(A1)	1.5	A	<b>5SG1 330</b>		1	6	016	0.068
	D02		63	(A1)	1.5	A	<b>5SG1 730</b>		1	6	016	0.087
Without cover												
	D01	1P	16	A1	1.5	B	<b>5SG1 331</b>		1	6	016	0.056
	D02		63	A1	1.5	A	<b>5SG1 731</b>		1	6	016	0.080
With cover												
	D01	3P	16	(A2)	4.5	A	<b>5SG5 330</b>		1	2	016	0.216
	D02		63	(A2)	4.5	A	<b>5SG5 730</b>		1	2	016	0.252

For busbars, see page 19/82 ff.

<sup>1)</sup> Covers in brackets are included in the scope of supply.  
Covers without brackets are not included in scope of supply.

	Size	Number of poles	$I_n$	Matching cover <sup>1)</sup>	Terminals <sup>2)</sup>	MW	DT	Order No.	Price per PU	PU	PS*	PG	Weight per PU approx.
			A							Unit(s)	Unit(s)		kg
<b>NEOZED fuse bases made of ceramic</b>													
With cover													
	D01	1P	16	(A4)	BB	1.5	▶	<b>5SG1 553</b>		1	6	016	0.083
	D02		63	(A10)	SS	1.5	▶	<b>5SG1 653</b>		1	6	016	0.093
	D02		63	(A10)	KS	1.5	▶	<b>5SG1 693</b>		1	6	016	0.090
Without cover													
	D01	1P	16	A4	BB	1.5	B	<b>5SG1 595</b>		1	6	016	0.071
	D02		63	A10	SS	1.5	▶	<b>5SG1 655</b>		1	6	016	0.081
	D02		63	A10	KS	1.5	B	<b>5SG1 695</b>		1	6	016	0.078
	D03		100	A6, A9	KS	2.5	A	<b>5SG1 812</b>		1	10	016	0.176
For screw connection only, without cover													
	D01	1P	16	A4	BB	1.5	B	<b>5SG1 590</b>		1	6	016	0.061
	D02		63	A10	SS	1.5	B	<b>5SG1 650</b>		1	6	016	0.078
	D03		100	A6, A9	KS	2.5	B	<b>5SG1 810</b>		1	10	016	0.176
With cap													
	D01	1P	16	(A8)	BB	1.5	▶	<b>5SG1 594</b>		1	6	016	0.105
	D02		63	(A8)	SS	1.5	B	<b>5SG1 694</b>		1	6	016	0.115
	D03		100	(A9)	KS	2.5	B	<b>5SG1 813</b>		1	10	016	0.242
With cover													
	D01	3P	16	(A5)	BB	4.5	▶	<b>5SG5 553</b>		1	2	016	0.263
	D02		63	(A11)	SS	4.5	▶	<b>5SG5 653</b>		1	2	016	0.240
	D02		63	(A11)	KS	4.5	▶	<b>5SG5 693</b>		1	2	016	0.290
Without cover													
	D01	3P	16	A5	BB	4.5	B	<b>5SG5 555</b>		1	2	016	0.228
	D02		63	A11	SS	4.5	B	<b>5SG5 655</b>		1	2	016	0.265
	D02		63	A11	KS	4.5	B	<b>5SG5 695</b>		1	2	016	0.255
For screw connection only, without cover													
	D01	3P	16	A5	BB	4.5	B	<b>5SG5 550</b>		1	2	016	0.228
	D02		63	A11	SS	4.5	B	<b>5SG5 650</b>		1	2	016	0.260
	D02		63	A11	KS	4.5	B	<b>5SG5 690</b>		1	2	016	0.250
<b>NEOZED covers</b>													
Made of molded plastic, plug-in for fuse base made of molded plastic													
	D01, D02			A1		1.5	C	<b>5SH5 244</b>		1	15	016	0.008
	D01, D02			A2		4.5	C	<b>5SH5 245</b>		1	5	016	0.017
For fuse bases made of ceramic													
	D01			A4		1.5	B	<b>5SH5 251</b>		1	15	016	0.012
	D02			A10		1.5	B	<b>5SH5 253</b>		1	15	016	0.020

<sup>1)</sup> Covers in brackets are included in the scope of supply.  
Covers without brackets are not included in the scope of supply.

<sup>2)</sup> For terminal versions, see page 19/69.

\* You can order this quantity or a multiple thereof.

# BETA Protecting Low-Voltage Fuse Systems



## NEOZED fuse systems

	Size	Matching cover	MW	DT	Order No.	Price per PU	PU	PS*	PG	Weight per PU approx.	
							Unit(s)	Unit(s)		kg	
<b>NEOZED covers</b>											
	D01	A5	4.5	C	<b>5SH5 252</b>		1	5	016	0.035	
	D02	A11	4.5	C	<b>5SH5 254</b>		1	5	016	0.045	
Screw-on											
	D03	A6	2.5	B	<b>5SH5 233</b>		1	20	016	0.021	
<b>NEOZED caps</b>											
Made of molded plastic, plug-in											
	D01, D02	A8		B	<b>5SH5 235</b>		1	5	016	0.034	
	Screw-on										
	D03	A9		C	<b>5SH5 234</b>		1	10	016	0.066	
<b>NEOZED screw caps</b>											
Molded plastic, with inspection hole											
	D01			▶	<b>5SH4 116</b>		1	10/1000	016	0.007	
	D02			▶	<b>5SH4 163</b>		1	10/200	016	0.008	
Ceramic											
	D01, sealable			A	<b>5SH4 316</b>		1	10	016	0.014	
	D02, sealable			A	<b>5SH4 363</b>		1	10	016	0.015	
	D03			A	<b>5SH4 100</b>		1	3	016	0.070	
Ceramic, with inspection hole											
	D01			▶	<b>5SH4 317</b>		1	20	016	0.014	
	D02			▶	<b>5SH4 362</b>		1	20	016	0.017	
Size	For fuse links	Identification color	MW	DT	Order No.	Price per PU	PU	PS*	PG	Weight per PU approx.	
	A						Unit(s)	Unit(s)		kg	
<b>NEOZED adapter sleeves</b>											
	D01	2		▶	<b>5SH5 002</b>		1	10	016	0.001	
		4	Pink	▶	<b>5SH5 004</b>		1	10	016	0.001	
		6	Brown	▶	<b>5SH5 006</b>		1	10	016	0.001	
		10/13	Green	▶	<b>5SH5 010</b>		1	10	016	0.001	
	D02	20	Blue	▶	<b>5SH5 020</b>		1	10	016	0.001	
		25	Yellow	▶	<b>5SH5 025</b>		1	10	016	0.001	
		32/35/40	Black	▶	<b>5SH5 035</b>		1	10	016	0.001	
		50	White	▶	<b>5SH5 050</b>		1	10	016	0.001	
		80	Silver	▶	<b>5SH5 080</b>		1	25	016	0.001	
	D03	80	Silver	A	<b>5SH5 080</b>		1	25	016	0.001	
	For fuse links D01 in base D02 and MINIZED switch disconnectors D02										
		D02	2	Pink	A	<b>5SH5 402</b>		1	10	016	0.001
			4	Brown	A	<b>5SH5 404</b>		1	10	016	0.001
			6	Green	A	<b>5SH5 406</b>		1	10	016	0.001
			10/13	Red	A	<b>5SH5 410</b>		1	10	016	0.001
		16	Gray	A	<b>5SH5 416</b>		1	10	016	0.001	

\* You can order this quantity or a multiple thereof.

# BETA Protecting Low-Voltage Fuse Systems

## NEOZED fuse systems

Size	For fuse links	Identification color	MW	DT	Order No.	Price per PU	PU	PS*	PG	Weight per PU approx.
	A						Unit(s)	Unit(s)		kg
<b>NEOZED adapter sleeve fitters</b>										
				A	<b>5SH5 100</b>		1	1/10	016	0.016
<b>NEOZED retaining springs</b>										
	For fuse links D01 in screw caps.			A	<b>5SH5 400</b>		1	25	016	0.001
	D02 2 ... 16			A	<b>5SH5 417</b>		1	25	016	0.001
	For fuse links D01 in screw caps DL			A	<b>5SH5 417</b>		1	25	016	0.001
	DL 2 ... 16			A	<b>5SH5 417</b>		1	25	016	0.001
<b>Busbar adapters</b>										
	For mounting MINIZED D02 switch disconnectors on busbars 12 x 5 mm at a distance of 40 mm		4.5	C	<b>5SH5 503</b>		1	1	016	0.280
	Rated current 63 A, 16 mm <sup>2</sup>									

### More information



Fuse base D01 with terminal type BB

- Incoming feeder, clamp-type terminal B
- Outgoing feeder, clamp-type terminal B



Fuse base D02 with terminal type KS

- Incoming feeder, screw head contact K
- Outgoing feeder, saddle terminal S



Fuse base D02 with terminal type SS

- Incoming feeder, saddle terminal S
- Outgoing feeder, saddle terminal S

\* You can order this quantity or a multiple thereof.

# BETA Protecting Low-Voltage Fuse Systems

## DIAZED fuse systems

### Overview

The DIAZED fuse system is one of the oldest fuse systems in the world. It was developed by Siemens as far back as 1906. It is still the standard fuse system in many countries to this day. It is particularly widely used in the harsh environments of industrial applications.

The series is available with rated voltages from 500 to 750 V.

All DIAZED bases must be fed from the bottom to ensure an insulated threaded ring when the fuse link is being removed. Reliable contact of the fuse links is only ensured when used together with DIAZED screw adapters.

The terminals of the DIAZED bases are available in different versions and designs to support the various installation methods.

The high-performing EZR bus-mounting system for screw connection is an outstanding feature. The busbars, which are particularly suited for bus-mounting bases, have a load capacity of up to 150 A with lateral infeed.

DIAZED stands for **D**iametral gestuftes **z**weiteiliges Sicherungssystem mit **E**disongewinde (diametral two-step fuse system with Edison screw).

### Benefits



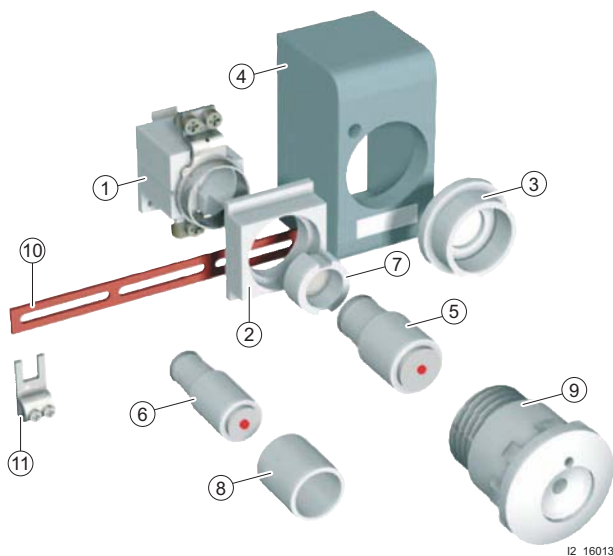





DIAZED fuse systems are a result of the well-designed modular system, the components can be combined in any way to meet the various requirements and to facilitate different installation methods.



I2\_16013

- ① DIAZED base
- ② DIAZED cover
- ③ DIAZED cover ring
- ④ DIAZED cap
- ⑤ DIAZED DII fuse link
- ⑥ DIAZED NDz fuse link
- ⑦ DIAZED screw adapter
- ⑧ DIAZED adapter sleeve
- ⑨ DIAZED screw cap
- ⑩ Busbar, oblong hole, single-phase
- ⑪ Terminal, fork-type terminal, non-insulated









## Selection and ordering data

	Size	$U_n$	$I_n$	Identification color	Thread	DT	Order No.	Price per PU	PU	PS*	PG	Weight per PU approx.
		V AC/ V DC	A						Unit(s)	Unit(s)		kg
<b>DIAZED fuse links</b>												
<b>Operational class gG</b>												
	DII	500/500	2	Pink	E27	▶	<b>5SB2 11</b>		1	5	016	0.026
			4	Brown			<b>5SB2 21</b>		1	5	016	0.026
			6	Green			<b>5SB2 31</b>		1	5	016	0.026
			10	Red			<b>5SB2 51</b>		1	5	016	0.027
			16	Gray			<b>5SB2 61</b>		1	5	016	0.028
			20	Blue			<b>5SB2 71</b>		1	5	016	0.029
			25	Yellow			<b>5SB2 81</b>		1	5	016	0.031
	DIII	500/500	32	Black	E33	B	<b>5SB4 010</b>		1	5	016	0.048
			35	Black			<b>5SB4 11</b>		1	5	016	0.050
			50	White			<b>5SB4 21</b>		1	5	016	0.051
			63	Copper			<b>5SB4 31</b>		1	5	016	0.054
	DIV	500/400	80	Silver	R1¼"	B	<b>5SC2 11</b>		1	3	016	0.110
			100	Red			<b>5SC2 21</b>		1	3	016	0.110
<b>Characteristic: slow</b>												
	TNDz	500/500	2	Pink	E16	B	<b>5SA2 11</b>		1	10	016	0.013
			4	Brown			<b>5SA2 21</b>		1	10	016	0.013
			6	Green			<b>5SA2 31</b>		1	10	016	0.013
			10	Red			<b>5SA2 51</b>		1	10	016	0.013
			16	Gray			<b>5SA2 61</b>		1	10	016	0.013
			20	Blue			<b>5SA2 71</b>		1	10	016	0.015
			25	Yellow			<b>5SA2 81</b>		1	10	016	0.016
<b>Characteristic: quick</b>												
	NDz	500/500	2	Pink	E16	B	<b>5SA1 11</b>		1	10	016	0.013
			4	Brown			<b>5SA1 21</b>		1	10	016	0.013
			6	Green			<b>5SA1 31</b>		1	10	016	0.013
			10	Red			<b>5SA1 51</b>		1	10	016	0.013
			16	Gray			<b>5SA1 61</b>		1	10	016	0.013
			20	Blue			<b>5SA1 71</b>		1	10	016	0.015
			25	Yellow			<b>5SA1 81</b>		1	10	016	0.016
	DII	500/500	2	Pink	E27	B	<b>5SB1 11</b>		1	5	016	0.026
			4	Brown			<b>5SB1 21</b>		1	5	016	0.026
			6	Green			<b>5SB1 31</b>		1	5	016	0.026
			10	Red <sup>1)</sup>			<b>5SB1 41</b>		1	5	016	0.026
			10	Red			<b>5SB1 51</b>		1	5	016	0.027
			16	Gray			<b>5SB1 61</b>		1	5	016	0.028
			20	Blue			<b>5SB1 71</b>		1	5	016	0.029
	DIII	500/500	25	Yellow	E33	A	<b>5SB1 81</b>		1	5	016	0.031
			35	Black			<b>5SB3 11</b>		1	5	016	0.050
			50	White			<b>5SB3 21</b>		1	5	016	0.051
	DIV	500/500	63	Copper	R1¼"	A	<b>5SB3 31</b>		1	5	016	0.054
			80	Silver			<b>5SC1 11</b>		1	3	016	0.110
			100	Red			<b>5SC1 21</b>		1	3	016	0.110
<b>Operational class gG, use 5SF1 and 5SF5 fuse bases made of ceramic, for 2 A ... 25 A, use DII screw adapters</b>												
	DIII	690/600	2	Pink	E33	B	<b>5SD8 002</b>		1	5	016	0.068
			4	Brown			<b>5SD8 004</b>		1	5	016	0.068
			6	Green			<b>5SD8 006</b>		1	5	016	0.068
			10	Red			<b>5SD8 010</b>		1	5	016	0.068
			16	Gray			<b>5SD8 016</b>		1	5	016	0.069
			20	Blue			<b>5SD8 020</b>		1	5	016	0.071
			25	Yellow			<b>5SD8 025</b>		1	5	016	0.072
			35	Black			<b>5SD8 035</b>		1	5	016	0.078
			50	White			<b>5SD8 050</b>		1	5	016	0.080
			63	Copper			<b>5SD8 063</b>		1	5	016	0.082

<sup>1)</sup> Use screw adapter 6 A.

# BETA Protecting Low-Voltage Fuse Systems









## DIAZED fuse systems

	Size	$U_n$ V AC/ V DC	$I_n$ A	Identifica- tion color	Thread	Terminals	DT	Order No.	Price per PU	PU Unit(s)	PS* Unit(s)	PG	Weight per PU approx. kg
<b>DIAZED fuse links</b>													
<b>Characteristic: quick, also for direct current railway facilities use for 2 A ... 25 A DII screw adapter</b>													
	DIII	750/750	2	Pink	E33		A	<b>5SD6 01</b>		1	5	016	0.068
			4	Brown			B	<b>5SD6 02</b>		1	5	016	0.068
			6	Green			B	<b>5SD6 03</b>		1	5	016	0.068
			10	Red			B	<b>5SD6 04</b>		1	5	016	0.068
			16	Gray			B	<b>5SD6 05</b>		1	5	016	0.069
			20	Blue			B	<b>5SD6 06</b>		1	5	016	0.071
			25	Yellow			A	<b>5SD6 07</b>		1	5	016	0.072
			35	Black			B	<b>5SD6 08</b>		1	5	016	0.078
			50	White			B	<b>5SD6 10</b>		1	5	016	0.080
			63	Copper			B	<b>5SD6 11</b>		1	5	016	0.082
	<b>DIAZED fuse bases made of ceramic</b>												
1P, for standard mounting rail													
	NDz	500/500	25		E16	KK	A	<b>5SF1 012</b>		1	5	016	0.060
	DII		25		E27	BB	▶	<b>5SF1 005</b>		1	5	016	0.093
	DIII <sup>1)</sup>		63		E33	BS	▶	<b>5SF1 205</b>		1	5	016	0.191
	DIII <sup>1)</sup>		63		E33	SS	B	<b>5SF1 215</b>		1	5	016	0.154
1P, for screw connection													
	NDz	500/500	25		E16	KK	A	<b>5SF1 01</b>		1	5	016	0.055
	DII		25		E27	BB	A	<b>5SF1 024</b>		1	5	016	0.093
	DIII <sup>1)</sup>		63		E33	BS	A	<b>5SF1 224</b>		1	5	016	0.137
	DIII <sup>1)</sup>		63		E33	SS	B	<b>5SF1 214</b>		1	5	016	0.141
1P, with flat connection													
	DIV		100		R1¼"		B	<b>5SF1 401</b>		1	1	016	0.380
3P, for standard mounting rail, with cap and N-type fixpoint terminal													
	DII	500/500	3 × 25		E27	BB	B	<b>5SF5 067</b>		1	1	016	0.400
	DIII <sup>1)</sup>		3 × 63		E33	BB	B	<b>5SF5 237</b>		1	1	016	0.580
3P, for screw connection, with cap and N-type fixpoint terminal													
	DII	500/500	3 × 25		E27	KB	B	<b>5SF5 066</b>		1	1	016	0.410
	DIII <sup>1)</sup>		3 × 63		E33	KB	B	<b>5SF5 236</b>		1	1	016	0.590
<b>DIAZED fuse bases made of molded plastic</b>													
With touch protection acc. to BGV A3													
1P, for standard mounting rail or screw connection													
	DII	500/500	25		E27		▶	<b>5SF1 060</b>		1	3/108	016	0.152
	DIII <sup>1)</sup>		63		E33		▶	<b>5SF1 260</b>		1	3/132	016	0.186
3P													
	DII	500/500	3 × 25		E27		▶	<b>5SF5 068</b>		1	1/36	016	0.457
	DIII <sup>1)</sup>		3 × 63		E33		▶	<b>5SF5 268</b>		1	1/44	016	0.538

<sup>1)</sup> Can also be used for 690 V AC/600 V DC.



## DIAZED fuse systems

	Size	$U_n$	$I_n$	Thread	Terminals	DT	Order No.	Price per PU	PU	PS*	PG	Weight per PU approx.
		V AC/V DC	A						Unit(s)	Unit(s)		kg
<b>DIAZED components 750 V</b>												
	DIAZED fuse bases 1P, for screw connection with fine thread and cap											
	DIII	750/750	63	E33S	KK	A	<b>5SF4 230</b>		1	1	016	0.460
	DIAZED screw caps Made of ceramic, with fine thread											
	DIII	750/750	63	E33S		A	<b>5SH1 161</b>		1	5	016	0.084
<b>DIAZED EZR bus-mounting bases</b>												
	1P, to snap onto EZR busbars For screw connection											
	DII	500/500	25	E27	B	B	<b>5SF6 005</b>		1	5	016	0.072
	DIII	500/500	63	E33	B	B	<b>5SF6 205</b>		1	5	016	0.135
<b>DIAZED screw caps</b>												
	Ceramic											
	NDz	500/500	25	E16		A	<b>5SH1 11</b>		1	5/200	016	0.016
	Molded plastic, with inspection hole, black, not for SILIZED fuse links											
	DII	500/500	25	E27		▶	<b>5SH1 221</b>		1	5/200	016	0.026
	DIII <sup>1)</sup>		63	E33		▶	<b>5SH1 231</b>		1	5/5000	016	0.042
	Ceramic											
	DII	500/500	25	E27		▶	<b>5SH1 12</b>		1	50/30000	016	0.034
	DIII <sup>1)</sup>		63	E33		▶	<b>5SH1 13</b>		1	30	016	0.059
	Ceramic, with inspection hole, sealable											
	DII	500/500	25	E27		A	<b>5SH1 22</b>		1	50/5000	016	0.050
	DIII <sup>1)</sup>		63	E33		A	<b>5SH1 23</b>		1	30/5000	016	0.076
	Ceramic											
	DIV	500/500	100	R1¼"		C	<b>5SH1 141</b>		1	1	016	0.181
	Ceramic, prolonged version											
	DIII	690/600	63	E33		A	<b>5SH1 170</b>		1	5	016	0.086

<sup>1)</sup> Can also be used for 690 V AC/600 V DC.

# BETA Protecting Low-Voltage Fuse Systems



## DIAZED fuse systems

	Size	Thread	For fuse links A	DT	Order No.	Price per PU	PU Unit(s)	PS* Unit(s)	PG	Weight per PU approx. kg
<b>DIAZED screw adapters</b>										
	NDz	E16	2	C	<b>5SH3 28</b>		1	20	016	0.002
			4	C	<b>5SH3 31</b>		1	20	016	0.002
			6	C	<b>5SH3 05</b>		1	20	016	0.002
			10	C	<b>5SH3 06</b>		1	20	016	0.002
			16	C	<b>5SH3 07</b>		1	20	016	0.002
Also for 5SF2 30 up to 750 V										
	DII	E27	2	▶	<b>5SH3 10</b>		1	25/5000	016	0.015
			4	▶	<b>5SH3 11</b>		1	25/5000	016	0.015
			6	▶	<b>5SH3 12</b>		1	25/250	016	0.015
			10	▶	<b>5SH3 13</b>		1	25/10000	016	0.015
			16	▶	<b>5SH3 14</b>		1	25/10000	016	0.014
			20	▶	<b>5SH3 15</b>		1	25/5000	016	0.012
25	▶	<b>5SH3 16</b>	1	25/10000	016	0.012				
Also for 5SF2 30 up to 750 V										
	DIII	E33	35	▶	<b>5SH3 17</b>		1	25/10000	016	0.019
			50	▶	<b>5SH3 18</b>		1	25/5000	016	0.018
			63	▶	<b>5SH3 20</b>		1	1/250	016	0.017
<b>DIAZED adapter sleeves</b>										
	DIV	R1¼"	80	C	<b>5SH3 21</b>		1	10/1000	016	0.006
			100	C	<b>5SH3 22</b>		1	10/1000	016	0.005
<b>DIAZED adapter sleeves for screw caps</b>										
	For NDz/TNDz fuse links in base DII			C	<b>5SH3 01</b>		1	10	016	0.012
	For DII fuse links in base DIII			B	<b>5SH3 02</b>		1	10	016	0.023
<b>DIAZED adapter sleeve fitters</b>										
	DII/DIII			A	<b>5SH3 703</b>		1	1	016	0.025
<b>DIAZED cover made of molded plastic</b>										
Not for SILIZED fuse links										
	DII	5 bases = 12 MW	E27	▶	<b>5SH2 032</b>		1	10/620	016	0.017
	DIII	4 bases = 12 MW	E33	▶	<b>5SH2 232</b>		1	10/620	016	0.020
<b>DIAZED caps made of molded plastic</b>										
	NDz	E16		A	<b>5SH2 01</b>		1	5	016	0.028
	DII	E27		A	<b>5SH2 02</b>		1	5	016	0.038
	DIII	E33		A	<b>5SH2 22</b>		1	5	016	0.048

\* You can order this quantity or a multiple thereof.

# BETA Protecting Low-Voltage Fuse Systems

## DIAZED fuse systems

Size	Thread	DT	Order No.	Price per PU	PU	PS*	PG	Weight per PU approx.
					Unit(s)	Unit(s)		kg
<b>DIAZED cover rings</b>								
Ceramic DII and DIII, also for EZR bus-mounting base								
	NDz	E16	C	<b>5SH3 30</b>	1	5	016	0.020
	DII	E27	B	<b>5SH3 32</b>	1	10	016	0.029
	DIII	E33	B	<b>5SH3 34</b>	1	10	016	0.035
Made of molded plastic, also for EZR bus-mounting base								
	DII	E27	A	<b>5SH3 401</b>	1	5/60	016	0.013
	DIII	E33	A	<b>5SH3 411</b>	1	5/60	016	0.014

### More information



Fuse base DIII with terminal type BS

- Outgoing feeder (top), saddle terminal S
- Incoming feeder (bottom), clamp-type terminal B



Fuse base NDZ with terminal type KK

- Outgoing feeder (top), screw head contact K
- Incoming feeder (bottom), screw head contact K



Fuse base DII with terminal type BB

- Outgoing feeder (top), clamp-type terminal B
- Incoming feeder (bottom), clamp-type terminal B



Fuse base DII with terminal type SS

- Outgoing feeder (top), saddle terminal S
- Incoming feeder (bottom), saddle terminal S

\* You can order this quantity or a multiple thereof.

# BETA Protecting Low-Voltage Fuse Systems

## 3NW cylindrical fuse systems

### Overview

Cylindrical fuses are standard in Europe. There are a range of different cylindrical fuse links and holders that comply with the standards IEC 60269-1, -2 and -3. They are suitable for use in industrial applications. In South West Europe they are also approved for use in residential buildings.

The cylindrical fuse holders are also approved to UL 512. The cylindrical fuse holders are tested and approved as fuse disconnectors in accordance with the switching device standard IEC 60947-3. They are not suitable for switching loads.





Cylindrical fuse holders can be supplied with or without signal detectors. In the case of devices with signal detectors, a small electronic device with LED is located behind an inspection window in the plug-in module. If the inserted fuse link is tripped, this is indicated by the LED flashing.

An auxiliary switch, which can be laterally mounted, enables the forwarding of the switching state of the fuse holder, and thus an integration of the fuses in the automation processes.

### Benefits

- The devices with pole number 1P+N are available in a single modular width. This reduces the footprint by 50 %.
- The sliding catch for type ranges 8 × 32 mm and 10 × 38 mm enables the removal of individual devices from the assembly
- Space for a spare fuse in the plug-in module enables the fast replacement of fuses. This saves time and money and increases plant availability.
- A flashing LED signals that a fuse link has been tripped. This enables fast detection during runtime.



### Selection and ordering data





	Size	$I_n$	$U_n$	DT	Order No.	Price per PU	PU	PS*	PG	Weight per PU approx.
	mm × mm	A	V AC				Unit(s)	Unit(s)		kg
<b>Cylindrical fuse links operational class gG</b>										
	8 × 32	2	400	B	<b>3NW6 302-1</b>		1	10	018	0.004
		4		B	<b>3NW6 304-1</b>		1	10	018	0.004
		6		B	<b>3NW6 301-1</b>		1	10	018	0.004
		10		B	<b>3NW6 303-1</b>		1	10	018	0.004
		16		B	<b>3NW6 305-1</b>		1	10	018	0.004
		20		B	<b>3NW6 307-1</b>		1	10	018	0.004
	10 × 38	2	500	▶	<b>3NW6 002-1</b>		1	10	018	0.008
		4		▶	<b>3NW6 004-1</b>		1	10	018	0.008
		6		▶	<b>3NW6 001-1</b>		1	10	018	0.008
		8		B	<b>3NW6 008-1</b>		1	10	018	0.008
		10		▶	<b>3NW6 003-1</b>		1	10	018	0.008
		12		B	<b>3NW6 006-1</b>		1	10/100	018	0.008
		16		▶	<b>3NW6 005-1</b>		1	10	018	0.008
		20		B	<b>3NW6 007-1</b>		1	10	018	0.008
		25		B	<b>3NW6 010-1</b>		1	10	018	0.008
		32		B	<b>3NW6 012-1</b>		1	10	018	0.008
	14 × 51	4	500	B	<b>3NW6 104-1</b>		1	10	018	0.019
		6		B	<b>3NW6 101-1</b>		1	10	018	0.019
		8		B	<b>3NW6 108-1</b>		1	10/100	018	0.019
		10		B	<b>3NW6 103-1</b>		1	10	018	0.019
		12		B	<b>3NW6 106-1</b>		1	10/100	018	0.019
		16		B	<b>3NW6 105-1</b>		1	10	018	0.019
		20		B	<b>3NW6 107-1</b>		1	10	018	0.019
		25		B	<b>3NW6 110-1</b>		1	10	018	0.019
		32		B	<b>3NW6 112-1</b>		1	10	018	0.019
		40		B	<b>3NW6 117-1</b>		1	10	018	0.019
50	B	<b>3NW6 120-1</b>		1	10	018	0.019			
	22 × 58	8	500	B	<b>3NW6 208-1</b>		1	10/100	018	0.051
		10		B	<b>3NW6 203-1</b>		1	10/100	018	0.051
		12		B	<b>3NW6 206-1</b>		1	10/100	018	0.051
		16		B	<b>3NW6 205-1</b>		1	10	018	0.051
		20		B	<b>3NW6 207-1</b>		1	10	018	0.051
		25		B	<b>3NW6 210-1</b>		1	10	018	0.051
		32		B	<b>3NW6 212-1</b>		1	10	018	0.051
		40		B	<b>3NW6 217-1</b>		1	10	018	0.051
		50		B	<b>3NW6 220-1</b>		1	10	018	0.051
		63		B	<b>3NW6 222-1</b>		1	10	018	0.051
80	B	<b>3NW6 224-1</b>		1	10	018	0.051			
100	B	<b>3NW6 230-1</b>		1	10	018	0.051			

\* You can order this quantity or a multiple thereof.

# BETA Protecting Low-Voltage Fuse Systems

## 3NW cylindrical fuse systems



Size	$I_n$	$U_n$	DT	Order No.	Price per PU	PU	PS*	PG	Weight per PU approx.	
mm × mm	A	V AC				Unit(s)	Unit(s)		kg	
<b>Cylindrical fuse links operational class aM</b>										
	10 × 38	0.5	500	B	<b>3NW8 000-1</b>		1	10	018	0.003
		1		B	<b>3NW8 011-1</b>		1	10	018	0.008
		2		B	<b>3NW8 002-1</b>		1	10	018	0.008
		4		B	<b>3NW8 004-1</b>		1	10	018	0.008
		6		B	<b>3NW8 001-1</b>		1	10	018	0.008
		8		B	<b>3NW8 008-1</b>		1	10	018	0.003
		10		A	<b>3NW8 003-1</b>		1	10	018	0.008
		12		B	<b>3NW8 006-1</b>		1	10/100	018	0.008
		16		B	<b>3NW8 005-1</b>		1	10	018	0.008
		20		B	<b>3NW8 007-1</b>		1	10	018	0.008
		25	400	B	<b>3NW8 010-1</b>		1	10	018	0.008
	14 × 51	2	500	B	<b>3NW8 102-1</b>		1	10/50	018	0.019
		4		B	<b>3NW8 104-1</b>		1	10	018	0.019
		6		B	<b>3NW8 101-1</b>		1	10/50	018	0.019
		8		B	<b>3NW8 108-1</b>		1	10/50	018	0.019
		10		B	<b>3NW8 103-1</b>		1	10	018	0.019
		12		B	<b>3NW8 106-1</b>		1	10/50	018	0.019
		16		B	<b>3NW8 105-1</b>		1	10	018	0.019
		20		B	<b>3NW8 107-1</b>		1	10	018	0.019
		25		B	<b>3NW8 110-1</b>		1	10	018	0.019
		32		B	<b>3NW8 112-1</b>		1	10	018	0.019
		40		B	<b>3NW8 117-1</b>		1	10	018	0.019
	22 × 58	10	500	B	<b>3NW8 203-1</b>		1	10/50	018	0.051
		12		B	<b>3NW8 206-1</b>		1	10/50	018	0.051
		16		B	<b>3NW8 205-1</b>		1	10/50	018	0.051
		20		B	<b>3NW8 207-1</b>		1	10	018	0.051
		25		B	<b>3NW8 210-1</b>		1	10	018	0.051
		32		B	<b>3NW8 212-1</b>		1	10	018	0.051
		40		B	<b>3NW8 217-1</b>		1	10	018	0.051
		50		B	<b>3NW8 220-1</b>		1	10	018	0.051
		63		B	<b>3NW8 222-1</b>		1	10	018	0.051
		80		B	<b>3NW8 224-1</b>		1	10	018	0.051
		100	400	B	<b>3NW8 230-1</b>		1	10	018	0.051

Number of poles	$I_n$	For fuse links of size	MW	DT	Order No.	Price per PU	PU	PS*	PG	Weight per PU approx.	
	A	mm × mm					Unit(s)	Unit(s)		kg	
<b>Cylindrical fuse holders with signal detector</b>											
	1P	20	8 × 32	1	C	<b>3NW7 314</b>		1	1	018	0.059
		32	10 × 38	1	A	<b>3NW7 014</b>		1	1	018	0.059
		50	14 × 51	1.5	B	<b>3NW7 112</b>		1	1	018	0.095
		100	22 × 58	2	B	<b>3NW7 212</b>		1	1	018	0.145
	1P+N	20	8 × 32	1	C	<b>3NW7 354</b>		1	1	018	0.072
		32	10 × 38	1	A	<b>3NW7 054</b>		1	1	018	0.072
		50	14 × 51	3	B	<b>3NW7 152</b>		1	1	018	0.215
		100	22 × 58	4	B	<b>3NW7 252</b>		1	1	018	0.330
	2P	20	8 × 32	2	C	<b>3NW7 324</b>		1	1	018	0.123
		32	10 × 38	2	A	<b>3NW7 024</b>		1	1	018	0.123
		50	14 × 51	3	B	<b>3NW7 122</b>		1	1	018	0.195
		100	22 × 58	4	B	<b>3NW7 222</b>		1	1	018	0.300
	3P	20	8 × 32	3	C	<b>3NW7 334</b>		1	1	018	0.180
		32	10 × 38	3	A	<b>3NW7 034</b>		1	1	018	0.180
		50	14 × 51	4.5	B	<b>3NW7 132</b>		1	1	018	0.295
		100	22 × 58	6	B	<b>3NW7 232</b>		1	1	018	0.480
	3P+N	20	8 × 32	3	C	<b>3NW7 364</b>		1	1	018	0.193
		32	10 × 38	3	A	<b>3NW7 064</b>		1	1	018	0.193
		50	14 × 51	6	B	<b>3NW7 162</b>		1	1	018	0.315
		100	22 × 58	8	B	<b>3NW7 262</b>		1	1	018	0.475

\* You can order this quantity or a multiple thereof.

# BETA Protecting Low-Voltage Fuse Systems

## 3NW cylindrical fuse systems

Number of poles	$I_n$	For fuse links of size mm x mm	MW	DT	Order No.	Price per PU	PU	PS*	PG	Weight per PU approx. kg
	A						Unit(s)	Unit(s)		
<b>Without signal detector</b>										
	<b>1P</b>									
	20	8 x 32	1	A	<b>3NW7 313</b>		1	25	018	0.056
	32	10 x 38	1	▶	<b>3NW7 013</b>		1	1/12	018	0.056
	50	14 x 51	1.5	▶	<b>3NW7 111</b>		1	1	018	0.095
	100	22 x 58	2	▶	<b>3NW7 211</b>		1	1	018	0.145
	<b>1P+N</b>									
	20	8 x 32	1	A	<b>3NW7 353</b>		1	1	018	0.069
	32	10 x 38	1	▶	<b>3NW7 053</b>		1	1	018	0.069
	50	14 x 51	3	B	<b>3NW7 151</b>		1	1	018	0.215
	100	22 x 58	4	B	<b>3NW7 251</b>		1	1	018	0.330
	<b>2P</b>									
	20	8 x 32	2	A	<b>3NW7 323</b>		1	1	018	0.118
	32	10 x 38	2	▶	<b>3NW7 023</b>		1	1/6	018	0.118
	50	14 x 51	3	▶	<b>3NW7 121</b>		1	1	018	0.195
	100	22 x 58	4	▶	<b>3NW7 221</b>		1	1	018	0.300
	<b>3P</b>									
	20	8 x 32	3	A	<b>3NW7 333</b>		1	1	018	0.172
	32	10 x 38	3	▶	<b>3NW7 033</b>		1	1/4	018	0.172
	50	14 x 51	4.5	▶	<b>3NW7 131</b>		1	1	018	0.295
	100	22 x 58	6	▶	<b>3NW7 231</b>		1	1	018	0.691
	<b>3P+N</b>									
	20	8 x 32	3	A	<b>3NW7 363</b>		1	1	018	0.185
	32	10 x 38	3	▶	<b>3NW7 063</b>		1	1	018	0.185
	50	14 x 51	6	A	<b>3NW7 161</b>		1	1	018	0.315
	100	22 x 58	8	A	<b>3NW7 261</b>		1	1	018	0.475
<b>Auxiliary switches</b>										
	For indicating disconnection of the fuse link, solely for application of striker fuse links. For retrofitting using the factory-fitted brackets. Contact: 250 V AC, 5 A Minimum contact load: 12 V, 25 mA									
	For fuse bases For fuse bases	14 x 51 22 x 58	0.5	B B	<b>3NW7 901</b> <b>3NW7 902</b>		1 1	1 1	018 018	0.050 0.050
For indicating the switching state of the fuse holder. For subsequent mounting with factory-fitted brackets. Contact: 230 V AC, 6 A/110 V DC, 1 A Minimum contact load: 12 V, 25 mA Terminals 1.5 mm <sup>2</sup> - 0.5 Nm										
	For fuse holders	10 x 38	0.5	B	<b>3NW7 903</b>		1	1	018	0.034

### More information

#### Mounting

Fuse holders size 8 mm x 32 mm and 10 mm x 38 mm have a sliding catch that enables the removal of individual devices from the assembly.

The infeed can be from the top or the bottom. Because the cylindrical fuse holders are fitted with the same anti-slip terminals at the top and the bottom, the devices can also be bus-mounted at the top or the bottom.

#### Auxiliary switches

Auxiliary switches are available for cylindrical fuse holders. These are simply clipped onto the base using the factory-fitted brackets.

Sizes 8 mm x 32 mm and 10 mm x 38 mm:  
The auxiliary switches support the remote display of the ON/OFF switching state of the fuse holder.

Sizes 14 mm x 51 mm and 22 mm x 58 mm:  
The auxiliary switches support the remote display of fuse failure. However, fuse links with strikers are required for this function. When the fuse is tripped, a small striking pin - the striker - shoots out of the front of the fuse. Over an armature link in the auxiliary switch, the kinetic energy of this striker is used to switch a mini switch, which then initializes this signal over a floating contact.

# BETA Protecting Low-Voltage Fuse Systems

## 3NW. ...-0HG Class CC fuse systems

### Overview

Class CC fuses are used for "branch circuit protection".

The encapsulated fuse holders are tested and designed to the US National Electrical Code NEC 210.20(A) so that in uninterrupted duty only 80 % of the rated current is permitted as operational current.

An operational current of 100 % of the rated current (30 A) is only permitted short-time.

The devices are prepared for the inscription labels of the ALPHA FIX terminal blocks 8WH8 120-7AA15 and 8WH8 120-7XA05.

There are three different series:

- Characteristic slow: 3NW1 ...-0HG  
For the protection of control transformers, reactors, inductances. Significantly slower than the minimum requirements of 12 s at  $2 \times I_n$  as specified by UL for Class CC fuses.
- Characteristic quick: 3NW2 ...-0HG  
For a wide range of applications, for the protection of lighting installations, heating, control systems.
- Characteristic slow: current-limiting 3NW3 ...-0HG  
slow for overloads and quick for short circuits. High current limiting for the protection of motor circuits.

### Benefits

- For switchgear assemblies and mechanical engineers who export their plants. Compliance with the American standard is as follows:
- Approved according to UL and CSA for typical "Branch Circuit Protection" applications. This facilitates export.
- Modern design with touch protection to BGV A3 ensures safe installation.

### Selection and ordering data

Number of poles	$U_n$	$I_n$	MW	DT	Order No.	Price per PU	PU	PS*	PG	Weight per PU approx. kg
	V	A					Unit(s)	Unit(s)		
<b>Class CC fuse holders</b>										
1P	600	30	1	C	<b>3NW7 513-0HG</b>		1	12	018	0.056
2P	600	30	2	C	<b>3NW7 523-0HG</b>		1	6	018	0.118
3P	600	30	3	C	<b>3NW7 533-0HG</b>		1	4	018	0.172



$I_n^{1)}$	DT	Characteristic: slow			Characteristic quick			PU	PS*	PG	Weight per PU approx. kg
		Order No.	Price per PU	PG	DT	Order No.	Price per PU				
A							Unit(s) <td>Unit(s) <td></td> <td></td> <td>kg</td> </td>	Unit(s) <td></td> <td></td> <td>kg</td>			kg
<b>Class CC fuse links</b>											
0.6 (6/10)	C	<b>3NW1 006-0HG</b>		018		--	1	10			0.008
0.8 (8/10)	C	<b>3NW1 008-0HG</b>		018		--	1	10			0.008
1	C	<b>3NW1 010-0HG</b>		018	C	<b>3NW2 010-0HG</b>	1	10	018		0.008
1.5 (1 1/2)	C	<b>3NW1 015-0HG</b>		018		--	1	10			0.008
2	C	<b>3NW1 020-0HG</b>		018	C	<b>3NW2 020-0HG</b>	1	10	018		0.008
3	C	<b>3NW1 030-0HG</b>		018	C	<b>3NW2 030-0HG</b>	1	10	018		0.008
4	C	<b>3NW1 040-0HG</b>		018	C	<b>3NW2 040-0HG</b>	1	10	018		0.008
5	C	<b>3NW1 050-0HG</b>		018	C	<b>3NW2 050-0HG</b>	1	10	018		0.008
6	C	<b>3NW1 060-0HG</b>		018	C	<b>3NW2 060-0HG</b>	1	10	018		0.008
8	C	<b>3NW1 080-0HG</b>		018	C	<b>3NW2 080-0HG</b>	1	10	018		0.008
10	C	<b>3NW1 100-0HG</b>		018	C	<b>3NW2 100-0HG</b>	1	10	018		0.008
12		--			C	<b>3NW2 120-0HG</b>	1	10	018		0.008
15	C	<b>3NW1 150-0HG</b>		018	C	<b>3NW2 150-0HG</b>	1	10	018		0.008
20	C	<b>3NW1 200-0HG</b>		018	C	<b>3NW2 200-0HG</b>	1	10	018		0.008
25	C	<b>3NW1 250-0HG</b>		018	C	<b>3NW2 250-0HG</b>	1	10	018		0.008
30	C	<b>3NW1 300-0HG</b>		018		--	1	10			0.008



\* You can order this quantity or a multiple thereof.

# BETA Protecting Low-Voltage Fuse Systems

## 3NW. ...-0HG Class CC fuse systems

$I_n^{1)}$	DT	Characteristic: slow current limiting		PU	PS*	PG	Weight per PU approx.
		Order No.	Price per PU				
A				Unit(s)	Unit(s)		kg
<b>Class CC fuse links</b>							
		--					
0.6 (6/10)		--					
0.8 (8/10)		--					
1	C	<b>3NW3 010-0HG</b>		1	10	018	0.008
1.5 (1 ½)		--					
2	C	<b>3NW3 020-0HG</b>		1	10	018	0.008
3	C	<b>3NW3 030-0HG</b>		1	10	018	0.008
4	C	<b>3NW3 040-0HG</b>		1	10	018	0.008
5	C	<b>3NW3 050-0HG</b>		1	10	018	0.008
6	C	<b>3NW3 060-0HG</b>		1	10	018	0.008
8	C	<b>3NW3 080-0HG</b>		1	10	018	0.008
10	C	<b>3NW3 100-0HG</b>		1	10	018	0.008
12	C	<b>3NW3 120-0HG</b>		1	10	018	0.008
15	C	<b>3NW3 150-0HG</b>		1	10	018	0.008
20	C	<b>3NW3 200-0HG</b>		1	10	018	0.008
25	C	<b>3NW3 250-0HG</b>		1	10	018	0.008
30	C	<b>3NW3 300-0HG</b>		1	10	018	0.008



<sup>1)</sup> Values in brackets, American designation.

\* You can order this quantity or a multiple thereof.



# BETA Protecting Low-Voltage Fuse Systems

## 5ST2, 5ST3 busbars for fuse systems

### Overview

Busbars with pin-type connections can be used for NEOZED safety switching devices and fuse bases. Busbars are available in 10 mm<sup>2</sup> and 16 mm<sup>2</sup>.

Busbars with fork plugs are used for the most frequently used NEOZED fuse bases made of ceramic.

### Benefits

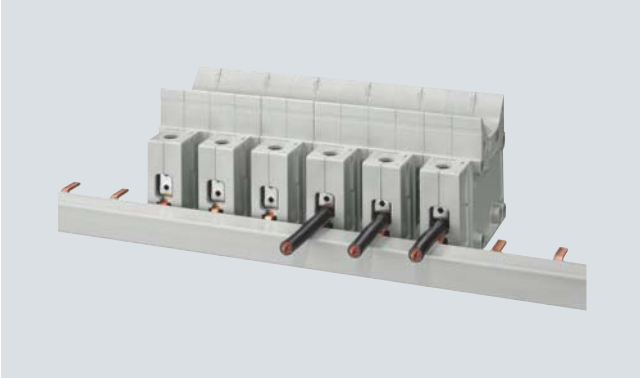

- Clear and visible conductor connection that can be easily checked when using NEOZED comfort base D02. This facilitates the insertion of conductors and saves time.

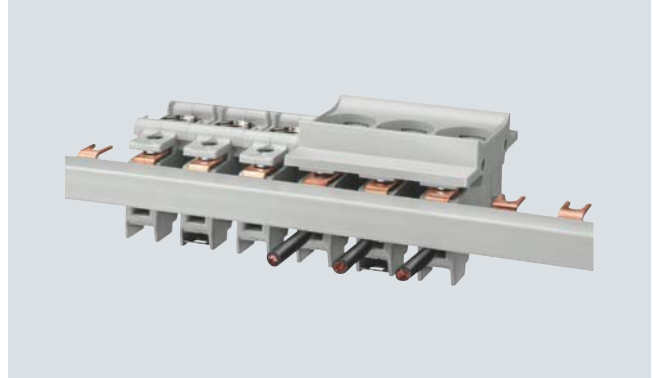

- Bus mounting of NEOZED fuse bases made of molded plastic on three-phase busbar with fork plug, which can be cut to length. Frequently used.



- Bus mounting of NEOZED fuse bases made of ceramic on three-phase busbar with fork plug, which can be cut to length. Most common application.

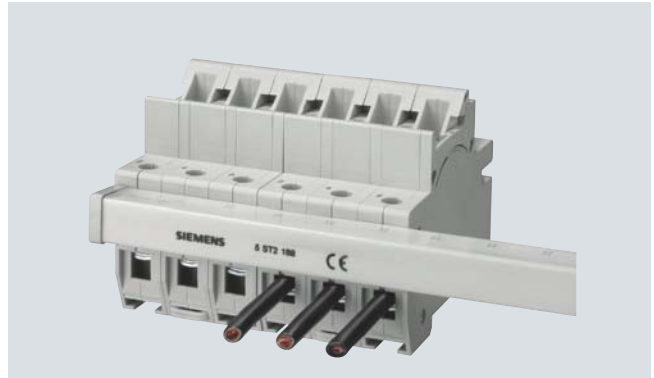

- Bus mounting of MINIZED fuse switch disconnectors D01 with 3-phase pin busbar, which can be cut to length. Tried and tested.



- Clear and visible conductor connection that can be easily checked when using MINIZED switch disconnectors D02. This facilitates the insertion of conductors and saves time.



- Bus mounting of cylindrical fuse holders 8 mm x 32 mm and 10 mm x 38 mm with three-phase pin busbar, which can be cut to length.

# BETA Protecting Low-Voltage Fuse Systems

## 5ST2, 5ST3 busbars for fuse systems

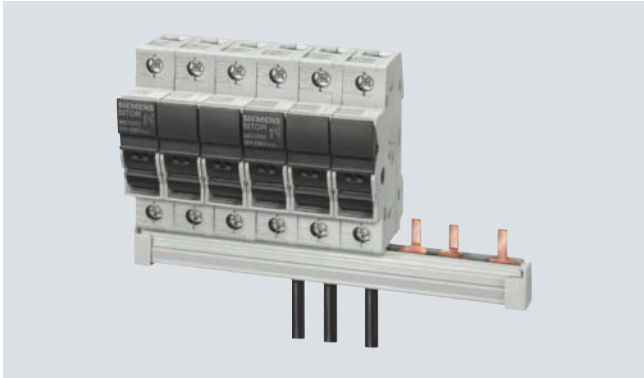



- Bus mounting of SITOR cylindrical fuse holders 10 mm x 38 mm with the same terminal connection as Class CC fuse holder with three-phase pin busbars, which can be cut to length.









- Bus mounting with infeed through a connection terminal directly on the fuse holder up to a conductor cross-section of 35 mm<sup>2</sup>.

### Selection and ordering data

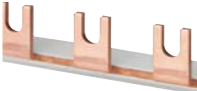
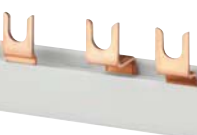
	Phase	Conductor cross-section mm <sup>2</sup>	Load capacity up to A	Pin spacing MW	Length mm	DT	Order No.	Price per PU	PU Unit(s)	PS* Unit(s)	PG	Weight per PU approx. kg
<b>Busbars</b>												
<b>For MINIZED D02 switch disconnectors, for NEOZED D01/D02 comfort bases</b> made of molded plastic 5SG1 301, 5SG1 701, 5SG5 301, 5SG5 701 <b>For NEOZED D01/D02 fuse bases made of ceramic, for 14 x 51 mm cylindrical fuse holders, for SITOR 14 x 51 mm cylindrical fuse holders</b> Terminal version S (saddle-type terminal connection) Can be cut to length, without end caps												
	Single-phase	16	130	1.5	1016	A	<b>5ST3 703</b>		1	1	027	0.190
	Three-phase	16	120	1.5	1016	A	<b>5ST3 714</b>		1	1	027	0.430
<b>For MINIZED D01 fuse switch disconnectors</b>												
Can be cut to length, without end caps												
	Single-phase	16	120	1	1000	B	<b>5ST2 190</b>		1	1	027	0.500
	Two-phase					B	<b>5ST2 191</b>		1	1	027	0.710
	Three-phase					B	<b>5ST2 192</b>		1	1	027	1.100
Can be cut to length, with 2 end caps												
	Single-phase	16	120	1	220	B	<b>5ST2 186</b>		1	1	027	0.090
	Two-phase					B	<b>5ST2 187</b>		1	1	027	0.160
	Three-phase					B	<b>5ST2 188</b>		1	1	027	0.230

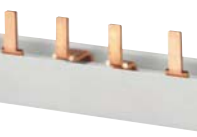
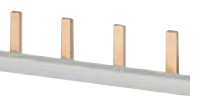
# BETA Protecting Low-Voltage Fuse Systems







## 5ST2, 5ST3 busbars for fuse systems

Phase	Conductor cross-section mm <sup>2</sup>	Load capacity up to A	Pin spacing MW	Length mm	DT	Order No.	Price per PU	PU Unit(s)	PS* Unit(s)	PG	Weight per PU approx. kg
<b>For NEOZED fuse bases D01/D02</b> made of molded plastic 5SG1 .30, 5SG1 .31, 5SG5 .30  <b>For NEOZED D01/D02 fuse bases</b> made of ceramic, terminal types B and K (clamp-type terminal, screw head contact)  Non-insulated											
 Single-phase	20	116	1.5	1000	▶	<b>5SH5 321</b>		1	1	016	0.214
	36	168	1.5		▶	<b>5SH5 322</b>		1	1	016	0.321
Can be cut to length, without end caps											
 Single-phase	24	160	1.5	1000	A	<b>5SH5 517</b>		1	1	016	0.550
 Three-phase											
16	120	1.5	1000	▶	<b>5SH5 320</b>		1	1	016	0.843	
<b>For 8 × 32 mm and 10 × 38 mm cylindrical fuse holders ,            for SITOR 10 × 38 mm cylindrical fuse holders,            for Class CC cylindrical fuse holders</b>  Can be cut to length, without end caps											
 Single-phase	16	120	1	1016	A	<b>5ST3 701</b>		1	1	027	0.190
	Two-phase	120	1		A	<b>5ST3 705</b>		1	1	027	0.290
 Three-phase	16	120	1	1016	▶	<b>5ST3 710</b>		1	1	027	0.430
Cannot be cut to length, fully insulated											
 Single-phase	16		1	214	▶	<b>5ST3 700</b>		1	1	027	0.040
	Two-phase		1		A	<b>5ST3 704</b>		1	1	027	0.060
	Three-phase		1		▶	<b>5ST3 708</b>		1	1	027	0.100
<b>End caps for busbars</b> For single-phase 5ST3 7, 5SH5 5 busbars 156 ▶ <b>5ST3 748</b> 1 10 027 0.001											
 For three-phase 5ST3 7 and 5SH5 320 busbars ▶ <b>5ST3 750</b> 1 10 027 0.001											
 <b>Touch protection for free connection of pin busbars</b> Yellow (RAL 1004) 5 x 1 pin A <b>5ST3 655</b> 1 10 027 0.003											
											

\* You can order this quantity or a multiple thereof.

# BETA Protecting Low-Voltage Fuse Systems

## 5ST2, 5ST3 busbars for fuse systems

Phase	Conductor cross-section mm <sup>2</sup>	Load capacity up to A	Length mm	DT	Order No.	Price per PU	PU Unit(s)	PS* Unit(s)	PG	Weight per PU approx. kg
<b>Terminals</b>										
For NEOZED fuse bases D01/D02 made of ceramic, For DIAZED fuse bases DII/DIII made of ceramic, For cylindrical fuse holders										
	Terminal version S For con- ductors	2 ... 25		▶	<b>5SH5 327</b>		1	10/300	016	0.014
	Terminal versions B and K For con- ductors	6 ... 25		▶	<b>5SH5 328</b>		1	10/300	016	0.014
	For the infeed of fork-type or pin busbars For con- ductors	6 ... 35		A	<b>5ST2 157</b>		1	5	027	0.030
<b>Busbars</b>										
<b>For 1-pole DIAZED fuse bases made of ceramic with terminal versions BB and BS</b>										
	Size DII, for 19 bases Single- phase	24	80	1000	A	<b>5SH3 500</b>	1	1/25	016	0.095
	Size DIII, for 25 bases Single- phase	39	120	1000	A	<b>5SH3 501</b>	1	1/25	016	0.180
<b>Busbars</b>										
<b>For DIAZED bus-mounting bases/EZR with thread for screw adapters</b>										
	For size DII, 42 5SF6 005 bases Single- phase	48	150	2000	C	<b>5SH3 54</b>	1	5	016	0.740
	For size DIII, 34 5SF6 205 bases Single- phase	48	150	2000	C	<b>5SH3 55</b>	1	5	016	0.740
<b>Bus-mounting terminals</b>										
For DIAZED EZR bus-mounting bases										
Non-insulated										
	For con- ductors	1.5 ... 16		A	<b>8JH4 122</b>		1	10	046	0.012
	For con- ductors	10 ... 35		A	<b>8JH4 124</b>		1	10	046	0.024

\* You can order this quantity or a multiple thereof.

## 5ST2, 5ST3 busbars for fuse systems

### 5ST3 7...-HG busbar systems acc. to UL 508

	Pin spacing	Length	DT	Order No.	Price per PU	PU	PS*	PG	Weight per PU approx.							
										MW	mm	Unit(s)	Unit(s)	kg		
<b>5ST3 7...-HG busbars acc. to UL 508, 18 mm<sup>2</sup>, can be cut, without end caps</b>																
	Single-phase															
	<ul style="list-style-type: none"> <li>For fuse holders 10 x 38 Class CC (3NC1 091, 3NW7 513-0HG) or MCB 1P (5SY)</li> </ul>	1	1000	A	<b>5ST3 701-0HG</b>		1	10	012	0.330						
	Two-phase															
	<ul style="list-style-type: none"> <li>For fuse holders 14 x 51 (3NC1 491, 3NW7 111) or MCB 1P (5SY, 5SP) with AS or FC</li> </ul>	1.5	1000	A	<b>5ST3 703-0HG</b>		1	10	012	0.330						
	three-phase															
	<ul style="list-style-type: none"> <li>For fuse holders 10 x 38/Class CC (3NC1 093, 3NW7 533-0HG) or MCB 3P (5SY)</li> </ul>	1	1000	A	<b>5ST3 710-0HG</b>		1	10	012	0.800						
	<ul style="list-style-type: none"> <li>For fuse holders 14 x 51 (3NC1 493, 3NW7 131) or MCB 1P (5SY, 5SP) with AS or FC</li> </ul>	1.5	1000	A	<b>5ST3 714-0HG</b>		1	10	012	0.820						
<b>5ST3 7...-HG busbars acc. to UL 508, 25 mm<sup>2</sup>, can be cut, without end caps</b>																
	Single-phase															
	<ul style="list-style-type: none"> <li>For fuse holders 14 x 51 (3NC1 491, 3NW7 111) or MCB 1P (5SP)</li> </ul>	1.5	1000	A	<b>5ST3 701-2HG</b>		1	10	012	0.450						
	Two-phase															
	<ul style="list-style-type: none"> <li>For fuse holders 14 x 51 (3NC1 492, 3NW7 121) or MCB 2P (5SP)</li> </ul>	1.5	1000	A	<b>5ST3 705-2HG</b>		1	10	012	0.690						
	three-phase															
	<ul style="list-style-type: none"> <li>For fuse holders 14 x 51 (3NC1 493, 3NW7 131) or MCB 3P (5SP)</li> </ul>	1.5	1000	A	<b>5ST3 710-2HG</b>		1	10	012	1.090						
<b>End caps for 5ST3 7...-HG</b>																
	For single-phase busbars															
				A	<b>5ST3 748-0HG</b>		1	10	012	0.001						
For two- and three-phase busbars										A	<b>5ST3 750-0HG</b>		1	10	012	0.001
<b>Connection terminals acc. to UL 508</b>																
	Infeed to device															
	<ul style="list-style-type: none"> <li>35 mm<sup>2</sup></li> </ul>			A	<b>5ST3 770-0HG</b>		1	10	012	0.035						
	Infeed to busbar															
	<ul style="list-style-type: none"> <li>50 mm<sup>2</sup></li> </ul>			A	<b>5ST3 770-1HG</b>		1	10	012	0.016						
<b>Touch protection covers for busbars acc. to UL 508</b>																
	5 x 1 pin															
				A	<b>5ST3 655-0HG</b>		1	10	012	0.003						

\* You can order this quantity or a multiple thereof.

# BETA Protecting Low-Voltage Fuse Systems

## 3NA, 3ND LV HRC fuse links

### Overview

LV HRC (NH type) fuse systems are used for installation systems in non-residential, commercial and industrial buildings, as well as in the systems of power supply companies. They therefore protect essential building parts and installations.

LV HRC fuse systems are fuse systems designed for operation by skilled personnel. There are no constructional requirements for non-interchangeability of rated current and touch protection.

The components and auxiliary equipment are designed in such a way as to ensure the safe replacement of LV HRC fuse systems or isolation of systems.

LV HRC fuse links are available in the sizes 000, 00, 0, 1, 2, 3, 4 and 4a.

LV HRC fuse links are available in the following operational classes:

- gG for cable and line protection
- aM for the short-circuit protection of switching devices in motor circuits
- gR or aR for the protection of power semiconductors
- gS: the new gS operational class combines cable and line protection with semiconductor protection.

LV HRC fuse links of size 000 can also be used in LV HRC fuse bases, LV HRC fuse switch disconnectors, LV HRC fuse strips as well as in LV HRC in-line fuse switch disconnectors of size 00.

The fuse links 300 A, 355 A and 425 A comply with the standard but do not have the VDE mark.

### LV HRC components

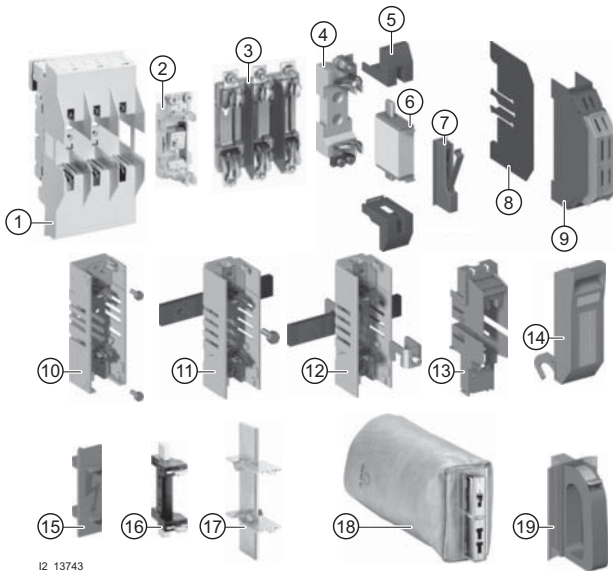

I2\_13743

- ① LV HRC fuse base from the SR60 busbar system
- ② LV HRC fuse base for busbar mounting
- ③ LV HRC fuse base, 3P
- ④ LV HRC fuse base, 1P
- ⑤ LV HRC contact covers
- ⑥ LV HRC fuse link
- ⑦ LV HRC signal detectors
- ⑧ LV HRC partition
- ⑨ LV HRC protective cover
- ⑩ LV HRC fuse bases with slewing equipment  
- for screw connection on mounting plate
- ⑪ - for screw connection on busbar system
- ⑫ - for claw fixing on busbar
- ⑬ LV HRC protective covers for LV HRC fuse bases with slewing equipment
- ⑭ LV HRC slewing equipment
- ⑮ LV HRC fuse base cover
- ⑯ LV HRC isolating link with insulated grip lugs
- ⑰ LV HRC isolating link with non-insulated grip lugs
- ⑱ LV HRC fuse puller with sleeve
- ⑲ LV HRC fuse puller

### Benefits

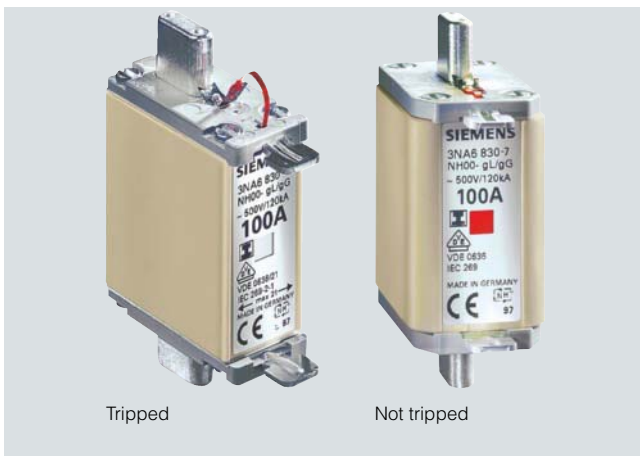

Tripped

Not tripped



Tripped

Not tripped





- LV HRC fuse links with combination alarm signal the tripping of a fuse by a clear color change from red to white. This enables fast identification and replacement of the tripped fuse links. This increases plant availability.
- The insulated grip lugs made of metal are integrated in the top and bottom covers of the fuse link in molded plastic and provide greater safety when replacing. The mark shown below indicates that the grip lugs are insulated. 

- In the standard series with front indicator, the front-mounted red indicator signals the tripping of a fuse.
- LV HRC fuse links are always equipped with silver-plated contact pins. This means that they are non-corroding and have less contact resistance. This ensures the long-term operational safety of the plant.

# BETA Protecting Low-Voltage Fuse Systems

## 3NA, 3ND LV HRC fuse links





### Selection and ordering data

Size	Width mm	$I_n$ A	$U_n$ V AC/ V DC	DT	Insulated grip lugs Order No.	Price per PU	PU	PS*	PG	Weight per PU approx. kg	
							Unit(s)	Unit(s)			
<b>LV HRC fuse links with combination alarm</b>											
<b>Operational class gG</b>											
	000	21	10	400/--	B	<b>3NA6 803-4</b>		1	3	013	0.135
			16		B	<b>3NA6 805-4</b>		1	3	013	0.135
			20		B	<b>3NA6 807-4</b>		1	3	013	0.135
			25		B	<b>3NA6 810-4</b>		1	3	013	0.135
			32		B	<b>3NA6 812-4</b>		1	3	013	0.135
			35		B	<b>3NA6 814-4</b>		1	3	013	0.135
			40		B	<b>3NA6 817-4</b>		1	3	013	0.135
			50		B	<b>3NA6 820-4</b>		1	3	013	0.135
			63		B	<b>3NA6 822-4</b>		1	3	013	0.135
			80		B	<b>3NA6 824-4</b>		1	3	013	0.135
		100	B	<b>3NA6 830-4</b>	1	3	013	0.135			
	00	30	80	400/--	B	<b>3NA6 824-4KK</b>		1	3	013	0.200
			100		B	<b>3NA6 830-4KK</b>		1	3	013	0.200
			125		B	<b>3NA6 832-4</b>		1	3	013	0.200
			160		B	<b>3NA6 836-4</b>		1	3	013	0.200
	1	30	35	400/--	B	<b>3NA6 114-4</b>		1	3	013	0.290
			40		B	<b>3NA6 117-4</b>		1	3	013	0.290
			50		B	<b>3NA6 120-4</b>		1	3	013	0.290
			63		B	<b>3NA6 122-4</b>		1	3	013	0.290
			80		B	<b>3NA6 124-4</b>		1	3	013	0.290
			100		B	<b>3NA6 130-4</b>		1	3	013	0.290
			125		B	<b>3NA6 132-4</b>		1	3	013	0.290
			160		B	<b>3NA6 136-4</b>		1	3	013	0.290
			200		B	<b>3NA6 140-4</b>		1	3	013	0.430
			224		B	<b>3NA6 142-4</b>		1	3	013	0.430
250	B	<b>3NA6 144-4</b>	1	3	013	0.430					
	2	47.2	50	400/--	B	<b>3NA6 220-4</b>		1	3	013	0.450
			63		B	<b>3NA6 222-4</b>		1	3	013	0.450
			80		B	<b>3NA6 224-4</b>		1	3	013	0.450
			100		B	<b>3NA6 230-4</b>		1	3	013	0.450
			125		B	<b>3NA6 232-4</b>		1	3	013	0.450
			160		B	<b>3NA6 236-4</b>		1	3	013	0.450
			200		B	<b>3NA6 240-4</b>		1	3	013	0.450
			224		B	<b>3NA6 242-4</b>		1	3	013	0.450
			250		B	<b>3NA6 244-4</b>		1	3	013	0.450
			300		B	<b>3NA6 250-4</b>		1	3	013	0.650
			315		B	<b>3NA6 252-4</b>		1	3	013	0.650
			355		B	<b>3NA6 254-4</b>		1	3	013	0.650
			400		B	<b>3NA6 260-4</b>		1	3	013	0.650

\* You can order this quantity or a multiple thereof.

# BETA Protecting Low-Voltage Fuse Systems

## 3NA, 3ND LV HRC fuse links





Size	Width	$I_n$	$U_n$	DT	Non-insulated grip lugs		Insulated grip lugs		PU	PS*	PG	Weight per PU approx. kg	
					Order No.	Price per PU	Order No.	Price per PU					
<b>LV HRC fuse links with combination alarm</b>													
<b>Operational class gG</b>													
	21	2	500/	B	<b>3NA7 802</b>		013	B	<b>3NA6 802</b>	1	3	013	0.135
		4	250	B	<b>3NA7 804</b>		013	B	<b>3NA6 804</b>	1	3	013	0.135
		6		B	<b>3NA7 801</b>		013	B	<b>3NA6 801</b>	1	3	013	0.135
		10		B	<b>3NA7 803</b>		013	B	<b>3NA6 803</b>	1	3	013	0.136
		16		▶	<b>3NA7 805</b>		013	▶	<b>3NA6 805</b>	1	3	013	0.136
		20		▶	<b>3NA7 807</b>		013	▶	<b>3NA6 807</b>	1	3	013	0.136
		25		▶	<b>3NA7 810</b>		013	▶	<b>3NA6 810</b>	1	3	013	0.600
		32		B	<b>3NA7 812</b>		013	B	<b>3NA6 812</b>	1	3	013	0.136
		35		▶	<b>3NA7 814</b>		013	▶	<b>3NA6 814</b>	1	3	013	0.440
		40		B	<b>3NA7 817</b>		013	B	<b>3NA6 817</b>	1	3	013	0.136
		50		▶	<b>3NA7 820</b>		013	▶	<b>3NA6 820</b>	1	3	013	0.128
		63		▶	<b>3NA7 822</b>		013	▶	<b>3NA6 822</b>	1	3	013	0.120
		80		▶	<b>3NA7 824</b>		013	▶	<b>3NA6 824</b>	1	3	013	0.128
		100		▶	<b>3NA7 830</b>		013	▶	<b>3NA6 830</b>	1	3	013	0.120
	30	80	500/	B	<b>3NA7 824-7</b>		013	B	<b>3NA6 824-7</b>	1	3	013	0.211
		100	250	B	<b>3NA7 830-7</b>		013	B	<b>3NA6 830-7</b>	1	3	013	0.211
		125		▶	<b>3NA7 832</b>		013	▶	<b>3NA6 832</b>	1	3	013	0.200
		160		▶	<b>3NA7 836</b>		013	A	<b>3NA6 836</b>	1	3	013	0.200
	30	16	500/	B	<b>3NA7 105</b>		013	B	<b>3NA6 105</b>	1	3	013	0.290
		20	440	B	<b>3NA7 107</b>		013	B	<b>3NA6 107</b>	1	3	013	0.290
		25		B	<b>3NA7 110</b>		013	B	<b>3NA6 110</b>	1	3	013	0.290
		35		B	<b>3NA7 114</b>		013	B	<b>3NA6 114</b>	1	3	013	0.290
		40		B	<b>3NA7 117</b>		013	B	<b>3NA6 117</b>	1	3	013	0.290
		50		B	<b>3NA7 120</b>		013	B	<b>3NA6 120</b>	1	3	013	0.290
		63		B	<b>3NA7 122</b>		013	B	<b>3NA6 122</b>	1	3	013	0.290
		80		B	<b>3NA7 124</b>		013	B	<b>3NA6 124</b>	1	3	013	0.290
		100		B	<b>3NA7 130</b>		013	▶	<b>3NA6 130</b>	1	3	013	0.290
		125		▶	<b>3NA7 132</b>		013	▶	<b>3NA6 132</b>	1	3	013	0.290
		160		▶	<b>3NA7 136</b>		013	▶	<b>3NA6 136</b>	1	3	013	0.290
		47.2	200	▶	<b>3NA7 140</b>		013	▶	<b>3NA6 140</b>	1	3	013	0.440
		224		B	<b>3NA7 142</b>		013	B	<b>3NA6 142</b>	1	3	013	0.440
		250		▶	<b>3NA7 144</b>		013	▶	<b>3NA6 144</b>	1	3	013	0.400
	47.2	35	500/	B	<b>3NA7 214</b>		013	B	<b>3NA6 214</b>	1	3	013	0.450
		50	440	B	<b>3NA7 220</b>		013	B	<b>3NA6 220</b>	1	3	013	0.450
		63		B	<b>3NA7 222</b>		013	B	<b>3NA6 222</b>	1	3	013	0.450
		80		B	<b>3NA7 224</b>		013	B	<b>3NA6 224</b>	1	3	013	0.450
		100		B	<b>3NA7 230</b>		013	B	<b>3NA6 230</b>	1	3	013	0.450
		125		B	<b>3NA7 232</b>		013	B	<b>3NA6 232</b>	1	3	013	0.450
		160		▶	<b>3NA7 236</b>		013	▶	<b>3NA6 236</b>	1	3	013	0.450
		200		▶	<b>3NA7 240</b>		013	▶	<b>3NA6 240</b>	1	3	013	0.450
		224		B	<b>3NA7 242</b>		013	B	<b>3NA6 242</b>	1	3	013	0.450
		250		▶	<b>3NA7 244</b>		013	▶	<b>3NA6 244</b>	1	3	013	0.450
		57.8	300		--			B	<b>3NA6 250</b>	1	3	013	0.641
		315		▶	<b>3NA7 252</b>		013	▶	<b>3NA6 252</b>	1	3	013	0.660
		355			--			B	<b>3NA6 254</b>	1	3	013	0.641
		400		▶	<b>3NA7 260</b>		013	▶	<b>3NA6 260</b>	1	3	013	0.660

\* You can order this quantity or a multiple thereof.



# BETA Protecting Low-Voltage Fuse Systems





## 3NA, 3ND LV HRC fuse links

Size	Width mm	$I_n$ A	$U_n$ V AC/ V DC	DT	Non-insulated grip lugs	Price per PU	PU Unit(s)	PS* Unit(s)	PG	Weight per PU approx. kg					
					Order No.										
<b>LV HRC fuse links with front indicator Operational class gG</b>															
	21	2	500/250	▶	<b>3NA3 802</b>		1	3	013	0.133					
		4		▶	<b>3NA3 804</b>						1	3	013	0.133	
		6		▶	<b>3NA3 801</b>						1	3	013	0.133	
		10		▶	<b>3NA3 803</b>						1	3	013	0.133	
		16		▶	<b>3NA3 805</b>						1	3	013	0.133	
		20		▶	<b>3NA3 807</b>						1	3	013	0.133	
		25		▶	<b>3NA3 810</b>						1	3	013	0.133	
		32		▶	<b>3NA3 812</b>						1	3	013	0.133	
		35		▶	<b>3NA3 814</b>						1	3/90	013	0.133	
		40		▶	<b>3NA3 817</b>						1	3	013	0.133	
		50		▶	<b>3NA3 820</b>						1	3/90	013	0.133	
		63		▶	<b>3NA3 822</b>						1	3/90	013	0.133	
		80		▶	<b>3NA3 824</b>						1	3/90	013	0.133	
		100		▶	<b>3NA3 830</b>						1	3/90	013	0.133	
		125		▶	<b>3NA3 832-8</b>						1	3/60	013	0.160	
		160		▶	<b>3NA3 836-8</b>						1	3/60	013	0.160	
	30	35	500/250	B	<b>3NA3 814-7</b>		1	3	013	0.200					
		50		B	<b>3NA3 820-7</b>						1	3	013	0.200	
		63		B	<b>3NA3 822-7</b>						1	3	013	0.200	
		80		B	<b>3NA3 824-7</b>						1	3	013	0.200	
		100		B	<b>3NA3 830-7</b>						1	3	013	0.200	
		125		▶	<b>3NA3 832</b>						1	3	013	0.217	
		160		▶	<b>3NA3 836</b>						1	3	013	0.217	
	30	6	500/440	B	<b>3NA3 001</b>		1	3	013	0.340					
		10		B	<b>3NA3 003</b>						1	3	013	0.340	
		16		B	<b>3NA3 005</b>						1	3	013	0.340	
		20		B	<b>3NA3 007</b>						1	3	013	0.340	
		25		B	<b>3NA3 010</b>						1	3	013	0.340	
		32		B	<b>3NA3 012</b>						1	3	013	0.340	
		35		B	<b>3NA3 014</b>						1	3	013	0.340	
		40		B	<b>3NA3 017</b>						1	3	013	0.340	
		50		B	<b>3NA3 020</b>						1	3	013	0.340	
		63		A	<b>3NA3 022</b>						1	3	013	0.340	
		80		B	<b>3NA3 024</b>						1	3	013	0.340	
		100		A	<b>3NA3 030</b>						1	3	013	0.340	
		125		A	<b>3NA3 032</b>						1	3	013	0.340	
160	A	<b>3NA3 036</b>	1	3	013	0.340									
	30	16	500/440	B	<b>3NA3 105</b>		1	3	013	0.290					
		20		B	<b>3NA3 107</b>						1	3	013	0.290	
		25		B	<b>3NA3 110</b>						1	3	013	0.290	
		35		B	<b>3NA3 114</b>						1	3	013	0.300	
		40		B	<b>3NA3 117</b>						1	3	013	0.300	
		50		B	<b>3NA3 120</b>						1	3	013	0.300	
		63		▶	<b>3NA3 122</b>						1	3	013	0.300	
		80		▶	<b>3NA3 124</b>						1	3	013	0.300	
		100		▶	<b>3NA3 130</b>						1	3	013	0.300	
		125		▶	<b>3NA3 132</b>						1	3	013	0.300	
		160		▶	<b>3NA3 136</b>						1	3	013	0.300	
		47.2		200	▶						<b>3NA3 140</b>	1	3	013	0.440
				224	A						<b>3NA3 142</b>	1	3	013	0.440
				250	▶						<b>3NA3 144</b>	1	3	013	0.440

\* You can order this quantity or a multiple thereof.

# BETA Protecting Low-Voltage Fuse Systems

## 3NA, 3ND LV HRC fuse links

Size	Width mm	$I_n$ A	$U_n$ V AC/ V DC	DT	Non-insulated grip lugs Order No.	Price per PU	PU	PS*	PG	Weight per PU approx. kg	
							Unit(s)	Unit(s)			
<b>LV HRC fuse links with front indicator Operational class gG</b>											
	2	47.2	35 50 63 80 100 125 160 200 224 250	500/440	B	<b>3NA3 214</b>		1	3	013	0.453
					B	<b>3NA3 220</b>		1	3	013	0.453
					A	<b>3NA3 222</b>		1	3	013	0.453
					A	<b>3NA3 224</b>		1	3	013	0.453
					A	<b>3NA3 230</b>		1	3	013	0.453
					A	<b>3NA3 232</b>		1	3	013	0.453
					▶	<b>3NA3 236</b>		1	3	013	0.453
					▶	<b>3NA3 240</b>		1	3	013	0.453
					▶	<b>3NA3 242</b>		1	3	013	0.453
					▶	<b>3NA3 244</b>		1	3	013	0.453
					A	<b>3NA3 250</b>		1	3	013	0.647
					▶	<b>3NA3 252</b>		1	3	013	0.647
					▶	<b>3NA3 254</b>		1	3	013	0.647
					▶	<b>3NA3 260</b>		1	3	013	0.647
						3		57.8	200 224 250 300 315 355 400	500/440	B
B	<b>3NA3 342</b>	1	3	013			0.640				
A	<b>3NA3 344</b>	1	3	013			0.647				
B	<b>3NA3 350</b>	1	3	013			0.647				
▶	<b>3NA3 352</b>	1	3	013			0.647				
A	<b>3NA3 354</b>	1	3	013			0.647				
▶	<b>3NA3 360</b>	1	3	013			0.647				
A	<b>3NA3 362</b>	1	3	013			1.000				
▶	<b>3NA3 365</b>	1	3	013			1.000				
▶	<b>3NA3 372</b>	1	3	013			1.000				
Can only be used with 3NH3 530 LV HRC fuse base											
	4 (IEC design)	101.8	630 800 1000 1250	500/440	B	<b>3NA3 472</b>		1	1	013	2.500
					A	<b>3NA3 475</b>		1	1	013	2.500
					A	<b>3NA3 480</b>		1	1	013	2.500
					A	<b>3NA3 482</b>		1	1	013	2.500
Can only be used with 3NH7 520 LV HRC fuse base											
	4a	101.8	500 630 800 1000 1250	500/440	B	<b>3NA3 665</b>		1	1	013	2.700
					B	<b>3NA3 672</b>		1	1	013	2.700
					A	<b>3NA3 675</b>		1	1	013	2.700
					A	<b>3NA3 680</b>		1	1	013	2.840
					A	<b>3NA3 682</b>		1	1	013	2.840

\* You can order this quantity or a multiple thereof.

# BETA Protecting Low-Voltage Fuse Systems





## 3NA, 3ND LV HRC fuse links

Size-	Width	$I_n$	$U_n$	DT	Non-insulated grip lugs				Insulated grip lugs				Weight per PU approx. kg	
					Order No.	Price per PU	PG	DT	Order No.	Price per PU	PU	PS*		PG
		A	V AC/ V DC								Unit(s)	Unit(s)		
<b>LV HRC fuse links with combination alarm Operational class gG</b>														
	21	2	690/	B	<b>3NA7 802-6</b>		013	B	<b>3NA6 802-6</b>		1	3	013	0.136
		4	250	B	<b>3NA7 804-6</b>		013	B	<b>3NA6 804-6</b>		1	3	013	0.136
		6		B	<b>3NA7 801-6</b>		013	B	<b>3NA6 801-6</b>		1	3	013	0.136
		10		B	<b>3NA7 803-6</b>		013	B	<b>3NA6 803-6</b>		1	3	013	0.136
		16		B	<b>3NA7 805-6</b>		013	B	<b>3NA6 805-6</b>		1	3	013	0.136
		20		B	<b>3NA7 807-6</b>		013	B	<b>3NA6 807-6</b>		1	3	013	0.136
		25		B	<b>3NA7 810-6</b>		013	B	<b>3NA6 810-6</b>		1	3	013	0.136
32		B	<b>3NA7 812-6</b>		013	B	<b>3NA6 812-6</b>		1	3	013	0.136		
35		B	<b>3NA7 814-6</b>		013	B	<b>3NA6 814-6</b>		1	3	013	0.136		
	30	40	690/	B	<b>3NA7 817-6</b>		013	B	<b>3NA6 817-6</b>		1	3	013	0.211
		50	250	B	<b>3NA7 820-6</b>		013	B	<b>3NA6 820-6</b>		1	3	013	0.211
		63		B	<b>3NA7 822-6</b>		013	B	<b>3NA6 822-6</b>		1	3	013	0.211
		80		B	<b>3NA7 824-6</b>		013	B	<b>3NA6 824-6</b>		1	3	013	0.211
		100		B	<b>3NA7 830-6</b>		013	B	<b>3NA6 830-6</b>		1	3	013	0.211
	30	50	690/	B	<b>3NA7 120-6</b>		013	B	<b>3NA6 120-6</b>		1	3	013	0.290
		63	440	B	<b>3NA7 122-6</b>		013	B	<b>3NA6 122-6</b>		1	3	013	0.290
		80		B	<b>3NA7 124-6</b>		013	B	<b>3NA6 124-6</b>		1	3	013	0.290
		100		B	<b>3NA7 130-6</b>		013	B	<b>3NA6 130-6</b>		1	3	013	0.290
		125		B	<b>3NA7 132-6</b>		013	B	<b>3NA6 132-6</b>		1	3	013	0.290
		160		B	<b>3NA7 136-6</b>		013	B	<b>3NA6 136-6</b>		1	3	013	0.290
		47.2	200	B	<b>3NA7 140-6</b>		013	B	<b>3NA6 140-6</b>		1	3	013	0.440
	47.2	80	690/	B	<b>3NA7 224-6</b>		013	B	<b>3NA6 224-6</b>		1	3	013	0.450
		100	440	B	<b>3NA7 230-6</b>		013	B	<b>3NA6 230-6</b>		1	3	013	0.450
		125		B	<b>3NA7 232-6</b>		013	B	<b>3NA6 232-6</b>		1	3	013	0.450
	57.8	160		B	<b>3NA7 236-6</b>		013	B	<b>3NA6 236-6</b>		1	3	013	0.450
		200		B	<b>3NA7 240-6</b>		013	B	<b>3NA6 240-6</b>		1	3	013	0.450
		224		B	<b>3NA7 242-6</b>		013	B	<b>3NA6 242-6</b>		1	3	013	0.660
		250		B	<b>3NA7 244-6</b>		013	B	<b>3NA6 244-6</b>		1	3	013	0.660
		300		B	<b>3NA7 250-6</b>		013	B	<b>3NA6 250-6</b>		1	3	013	0.660
		315		B	<b>3NA7 252-6</b>		013	B	<b>3NA6 252-6</b>		1	3	013	0.660

\* You can order this quantity or a multiple thereof.





# BETA Protecting Low-Voltage Fuse Systems

## 3NA, 3ND LV HRC fuse links

Size	Width mm	$I_n$ A	$U_n$ V AC/ V DC	DT	Non-insulated grip lugs	Price per PU	PU Unit(s)	PS* Unit(s)	PG	Weight per PU approx. kg
					Order No.					
<b>LV HRC fuse links with front indicator Operational class gG</b>										
	000	21	690/250	▶	▶				013	0.135
					▶					
					▶					
					▶					
					▶					
					▶					
					▶					
					▶					
					▶					
	00	30	690/250	▶	▶				013	0.200
					▶					
					▶					
					▶					
					▶					
	1	30	690/440	▶	B				013	0.290
					B					
					B					
					▶					
					▶					
					▶					
					▶					
					▶					
					▶					
	2	47.2	690/440	▶	B				013	0.426
					B					
					B					
					▶					
					▶					
					▶					
					▶					
					▶					
					▶					
	3	57.8	690/440	▶	B				013	0.660
					B					
					B					
					▶					
					▶					
					▶					
					▶					
					▶					
					▶					

# BETA Protecting Low-Voltage Fuse Systems

## 3NA, 3ND LV HRC fuse links

Size	Width mm	$I_n$ A	$U_n$ V AC/ V DC	DT	Non-insulated grip lugs Order No.	Price per PU	PU	PS*	PG	Weight per PU approx. kg					
							Unit(s)	Unit(s)							
<b>LV HRC fuse links with front indicator</b>															
<b>Operational class aM</b>															
	000	21	500/--	B	3ND1 801		1	3	014	0.130					
					3ND1 803										
					3ND1 805										
					3ND1 807										
					3ND1 810										
					3ND1 812										
					3ND1 814										
					3ND1 817										
					3ND1 820										
					3ND1 822										
3ND1 824															
	00	30	500/--	B	3ND1 830		1	3	014	0.192					
					3ND1 832										
					3ND1 836										
	1	30	690/--	B	3ND2 122		1	3	014	0.290					
					3ND2 124										
					3ND2 130										
		47.2		B	3ND2 132							1	3	014	0.440
					3ND2 136										
					3ND2 140										
					3ND2 144										
	2	47.2	690/--	B	3ND2 232		1	3	014	0.440					
					3ND2 236										
					3ND2 240										
		57.8		B	3ND2 244							1	3	014	0.440
					3ND2 252										
					3ND2 254										
					3ND2 260										
	3	57.8	690/--	B	3ND2 352		1	3	014	0.650					
					3ND2 354										
					3ND2 360										
		71.2		B	3ND1 365							1	3	014	1.030
					3ND1 372										

\* You can order this quantity or a multiple thereof.

# BETA Protecting Low-Voltage Fuse Systems

## 3NX1 LV HRC signal detectors

### Overview

LV HRC (NH type) signal detectors are used for remotely indicating that the LV HRC fuse links have been tripped. Three different solutions are available:

- **3NX1 021** signal detectors with signal detector links  
The LV HRC signal detectors with signal detector link support monitoring of LV HRC fuse links with non-insulated grip lugs of sizes 000 to 4 at 10 A or more.  
The signal detector link is connected in parallel to the LV HRC fuse link. In the event of a fault, the LV HRC fuse links are released simultaneously with the fuse signaling link. A tripping pin switches a floating microswitch.

- **3NX1 024** signal detector top  
The signal detector top can be used with LV HRC fuse links, sizes 000, 00, 1 and 2, which are equipped with non-insulated grip lugs and have a front indicator or combination alarm. It is simply plugged into the grip lugs.
- **5TT3 170** fuse monitors  
If a fuse is tripped, the front indicator springs open and switches a floating microswitch. This solution should not be used for safety-relevant plants. For this purpose, we recommend our electronic fuse monitors.

### Benefits

#### Uniform solution for all sizes

LV HRC signal detectors reliably indicate when a fuse has tripped. Tripped fuses are quickly located. This saves time and increases plant availability.

- ① LV HRC fuse link
- ② LV HRC signal detectors
- ③ Microswitch
- ④ Spring contact
- ⑤ Hinged lid
- ⑥ Signal detector links

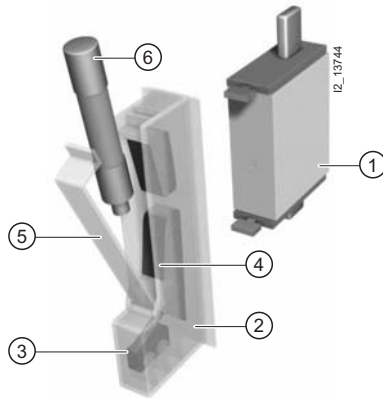

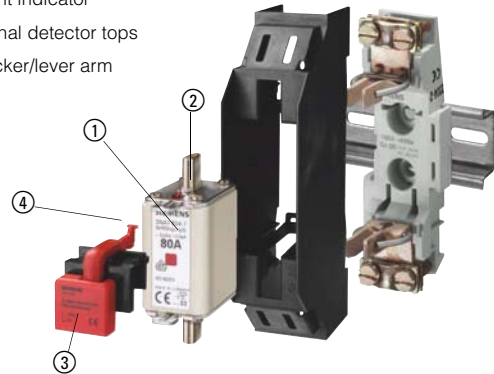

The LV HRC signal detector top is a cost-effective solution for monitoring Siemens LV HRC fuse links of sizes 000, 00, 1 and 2.

- ① LV HRC fuse link
- ② Front indicator
- ③ Signal detector tops
- ④ Rocker/lever arm



### Selection and ordering data

	Size	DT	Order No.	Price per PU	PU Unit(s)	PS* Unit(s)	PG	Weight per PU approx. kg
	000 to 4	A	<b>3NX1 021</b>		1	1	014	0.036
	<b>LV HRC signal detectors</b> Only for SIEMENS 3NA3, 3NA7 and 3ND LV HRC fuse links with non-insulated grip lugs • Rated voltage up to 690 V AC/600 V DC • Contact: microswitch 250 V AC, 6 A • Connection: flat termination 2.3 mm							
	000 to 4	A	<b>3NX1 022</b>		1	3	014	0.015
		C	<b>3NX1 023</b>		1	3	014	0.015
	<b>Signal detector links</b> • Rated voltage up to 690 V AC/600 V DC Response value > 9 V; 2.5 A; for standard applications Response value > 2 V; 7 A; only for meshed systems							
	000, 00, 1, 2	▶	<b>3NX1 024</b>		1	1	014	0.010
	<b>Signal detector tops</b> Only for SIEMENS 3NA3, 3NA7 and 3ND LV HRC fuse links with non-insulated grip lugs • Rated voltage up to 690 V AC/600 V DC • Contact: microswitch 230 V AC, 5 A, 1 CO • Connection: flat termination 2.3 mm							

\* You can order this quantity or a multiple thereof.

# BETA Protecting Low-Voltage Fuse Systems

3NX1 LV HRC signal detectors  
3NH LV HRC fuse bases

## 3NX1 LV HRC signal detectors

$U_e$	$I_n$	$U_c$	MW	DT	Order No.	Price per PU	PU	PS*	PG	Weight per PU approx.
V AC	A	V					Unit(s)	Unit(s)		kg
 <p><b>Fuse monitors</b> For all low-voltage fuse systems. Can be used in asymmetric systems afflicted with harmonics and regenerative feedback motors. Signal also for disconnected loads.</p>										
230	4	3 AC 380 ... 415	2	▶	<b>5TT3 170</b>		1	1	027	0.150

For more information on fuse monitors, please refer to Chapter "Monitoring of electrical values" in Catalog ET B1.

## Overview

### 3NH LV HRC fuse bases

#### Terminals for all applications

Terminals are as different as the requirements of individual systems.



Flat terminals with screws are suitable for connecting busbars or cable lugs. They have a torsion-proof screw connection with shim, spring washer and nut. When tightening the nut, always ensure compliance with the specified torque due to the considerable leverage effect.

The double busbar terminal differs from the flat terminal in that it supports connection of two busbars, one on the top and one at the bottom of the flat terminal.



In the case of flat terminals with nuts, connection of the nut to the terminal lug is torsion-proof. When tightening the nut, the torque must be observed because of the considerable leverage effect.

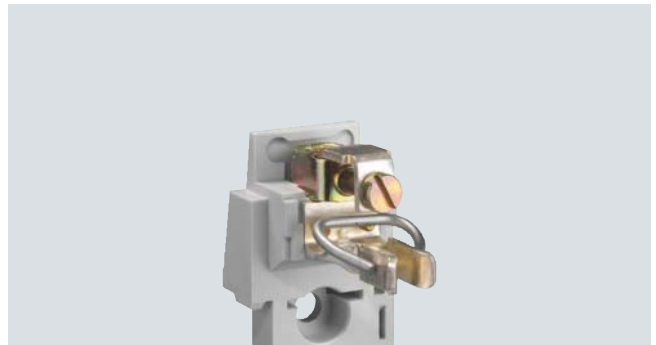

The modern box terminal ensures efficient and reliable connection to the conductors. They support connection of conductors with or without end sleeves.



Up to three conductors can be clamped to the terminal strip.

\* You can order this quantity or a multiple thereof.

# BETA Protecting Low-Voltage Fuse Systems

## 3NH LV HRC fuse bases



The plug-in terminal is equipped for connecting two conductors.



One conductor can be clamped to the saddle-type terminal.







### Benefits



- The silver-plated lyre-shaped contact provides a large contact area for the contact pin of the LV HRC fuse link. This improves heat transmission and lowers the temperature. It also minimizes aging of the fuse link in the maximum load range, in particular when using SITOR fuses
- The large contact area also facilitates replacement of LV HRC fuse links
- The spring washer that tensions the contact is mechanically galvanized. This will prevent hydrogen embrittlement. The contact is resistant to aging and there will be no dreaded annealing of contacts, which considerably improves operating safety.









## Selection and ordering data

Size	$I_n$	Version	DT	Order No.	Price per PU	PU Unit(s)	PS* Unit(s)	PG	Weight per PU approx. kg	
<b>LV HRC fuse bases</b>										
Made of molded plastic, for standard rail mounting or screw fixing										
	000/00	1P								
		160	With flat terminals, screw	▶	<b>3NH3 051</b>		1	1/10	014	0.119
			With saddle-type terminals	▶	<b>3NH3 052</b>		1	1/10	014	0.114
	125	With box terminals, up to 50 mm <sup>2</sup>	▶	<b>3NH3 053</b>		1	1/10	014	0.109	
Made of ceramic for screw fixing										
	000/00	1P								
		160	With flat terminals, screw	▶	<b>3NH3 030</b>		1	3	014	0.235
			With plug-in terminals	B	<b>3NH3 031</b>		1	3	014	0.230
			With saddle-type terminals	▶	<b>3NH3 032</b>		1	3	014	0.266
			With flat terminals and terminal strip	B	<b>3NH3 035</b>		1	3	014	0.230
			With flat terminals, nut	B	<b>3NH3 038</b>		1	3	014	0.207
			With flat and saddle-type terminals	B	<b>3NH3 050</b>		1	3	014	0.227
			3P (incl. two partitions)							
			With flat terminals	▶	<b>3NH4 030</b>		1	1	014	0.700
			With plug-in terminals	B	<b>3NH4 031</b>		1	1	014	0.800
	With saddle-type terminals	B	<b>3NH4 032</b>		1	1	014	0.800		
	With flat terminals and terminal strip	B	<b>3NH4 035</b>		1	1	014	0.750		
Made of ceramic for screw fixing										
	0	160	1P							
			With flat terminals	A	<b>3NH3 120</b>		1	3	014	0.460
			With plug-in terminals	B	<b>3NH3 122</b>		1	3	014	0.460
Made of ceramic for screw fixing										
	1	250	1P							
			With flat terminals	▶	<b>3NH3 230</b>		1	3	014	0.789
			With double busbar terminals	B	<b>3NH3 220</b>		1	3	014	0.789
Ceramic support on base plate for screw fixing										
	1	250	3P (incl. two partitions) With flat terminals	A	<b>3NH4 230</b>		1	1	014	2.100
Made of ceramic for screw fixing										
	2	400	1P							
			With flat terminals	▶	<b>3NH3 330</b>		1	1	014	0.843
			With double busbar terminals	A	<b>3NH3 320</b>		1	1	014	1.000
Made of ceramic for screw fixing										
	3	630	1P							
			With flat terminals	▶	<b>3NH3 430</b>		1	1	014	1.100
			With double busbar terminals	A	<b>3NH3 420</b>		1	1	014	1.100

\* You can order this quantity or a multiple thereof.

# BETA Protecting Low-Voltage Fuse Systems









## 3NH LV HRC fuse bases

Size	$I_n$	Version	DT	Order No.	Price per PU	PU	PS*	PG	Weight per PU approx.
						Unit(s)	Unit(s)		kg
<b>LV HRC fuse bases</b>									
Ceramic support on base plate for screw fixing (IEC design)									
	4	1250 1P With flat terminals	A	<b>3NH3 530</b>		1	1	014	3.000
<b>LV HRC bus-mounting bases made of molded plastic</b>									
For busbars 12 mm × 5 mm to 12 mm × 10 mm, busbar spacing 40 mm									
	000/00	160 1P With saddle-type terminals at top With saddle-type terminals at bottom	B B	<b>3NH3 036</b> <b>3NH3 037</b>		1 1	1 1	014 014	0.150 0.150
	000/00	80 3P, in tandem design 3 outgoing feeders at top and bottom respectively, with saddle-type terminal With 4 partitions With 2 non-interrupted partitions	B B	<b>3NH4 037</b> <b>3NH4 045</b>		1 1	1 1	014 014	0.800 0.800
<b>LV HRC fuse bases with slewing equipment</b>									
With flat terminals and additional saddle-type terminals (included)									
	000/00	160 1P With screw fixing for mounting plate With claw fixing for non-perforated busbar With screw fixing for perforated busbar	A B B	<b>3NH7 030</b> <b>3NH7 031</b> <b>3NH7 032</b>		1 1 1	1 1 1	014 014 014	1.000 1.000 1.000
	1	250 1P With screw fixing for mounting plate With claw fixing for non-perforated busbar With screw fixing for perforated busbar	A B B	<b>3NH7 230</b> <b>3NH7 231</b> <b>3NH7 232</b>		1 1 1	1 1 1	014 014 014	2.500 2.500 2.500
Can also be used for fuse links of size 2									
	3	630 1P With screw fixing for mounting plate With claw fixing for non-perforated busbar With screw fixing for perforated busbar, can be used as disconnecter	B B B	<b>3NH7 330</b> <b>3NH7 331</b> <b>3NH7 332</b>		1 1 1	1 1 1	014 014 014	4.800 4.800 4.800

\* You can order this quantity or a multiple thereof.

# BETA Protecting Low-Voltage Fuse Systems





## 3NH LV HRC fuse bases

Size	$I_n$	Version	DT	Order No.	Price per PU	PU	PS*	PG	Weight per PU approx.
						Unit(s)	Unit(s)		kg
<b>LV HRC fuse bases with slewing equipment</b>									
	4a	1250 1P							
		With screw fixing for mounting plate	A	<b>3NH7 520</b>		1	1	014	5.200
<b>LV HRC contact covers for LV HRC fuse bases</b>									
	Touch protection for contact pieces								
<b>000/00</b>			▶	<b>3NX3 105</b>		1	2/20	014	0.013
<b>0</b>			▶	<b>3NX3 114</b>		1	2/40	014	0.010
<b>1</b>			▶	<b>3NX3 106</b>		1	2/20	014	0.027
<b>2</b>			▶	<b>3NX3 107</b>		1	2/12	014	0.031
<b>3</b>			▶	<b>3NX3 108</b>		1	2/10	014	0.038
<b>LV HRC partitions for LV HRC fuse bases</b>									
	As intermediate phase and end barrier								
<b>000/00</b>		Type							
		3NH3 0/3NH4 0	▶	<b>3NX2 023</b>		1	2	014	0.025
<b>0</b>		3NH3 1	B	<b>3NX2 030</b>		1	2	014	0.050
<b>1</b>		3NH3 2	▶	<b>3NX2 024</b>		1	2	014	0.053
<b>2</b>		3NH3 3	▶	<b>3NX2 025</b>		1	2	014	0.066
<b>3</b>		3NH3 4	▶	<b>3NX2 026</b>		1	2	014	0.101
<b>LV HRC protective covers IP2X</b>									
	For LV HRC fuse bases								
<b>000/00</b>		1P and 3P	B	<b>3NX3 115</b>		1	10	014	0.039
<b>LV HRC covers</b>									
	For plugging into IP2X LV HRC protective covers								
<b>000/00</b>			B	<b>3NX3 116</b>		1	10	014	0.014
<b>LV HRC contact covers for LV HRC bus-mounting bases</b>									
	Touch protection for contact pieces								
<b>000/00</b>		Outgoing terminal	▶	<b>3NX3 105</b>		1	2/20	014	0.013
		Incoming terminal	B	<b>3NX3 113</b>		1	2/50	014	0.006
<b>LV HRC partitions for 3NH3 0 LV HRC bus-mounting bases</b>									
	As intermediate partition								
<b>000/00</b>			C	<b>3NX2 027</b>		1	2	014	0.017
	As end barrier								
<b>000/00</b>			C	<b>3NX2 028</b>		1	2/50	014	0.020

\* You can order this quantity or a multiple thereof.

# BETA Protecting Low-Voltage Fuse Systems

## 3NH LV HRC fuse bases

	Size	Version	DT	Order No.	Price per PU	PU Unit(s)	PS* Unit(s)	PG	Weight per PU approx. kg
	<b>000/00</b>	For 3NH4 0 LV HRC bus-mounting bases	C	<b>3NX2 031</b>		1	2/30	014	0.050
	<b>Non-interrupted partitions</b>								
	<b>000/00</b> <b>1, 2, 3</b>	For LV HRC fuse bases, red With inscription "isolating point"	C C	<b>3NX1 003</b> <b>3NX1 004</b>		1 1	3 3	014 014	0.050 0.100
	<b>Fuse-base covers,</b> for LV HRC fuse bases, red With inscription "isolating point"								
	<b>000 to 4</b>	For LV HRC fuse links Without sleeve With sleeve	▶ ▶	<b>3NX1 013</b> <b>3NX1 014</b>		1 1	1 1	014 014	0.280 0.480
	<b>Fuse pullers</b>								
	<b>000/00</b> <b>0</b> <b>1</b> <b>2</b> <b>3</b>	for LV HRC fuse bases and fuse switch disconnectors With insulated grip lugs Silver-plated	▶ C ▶ ▶ ▶	<b>3NG1 002</b> <b>3NG1 102</b> <b>3NG1 202</b> <b>3NG1 302</b> <b>3NG1 402</b>		1 1 1 1 1	3/30 1/10 1/10 1/5 1/5	014 014 014 014 014	0.080 0.110 0.170 0.240 0.290
	<b>Isolating links</b> for LV HRC fuse bases and fuse switch disconnectors With insulated grip lugs								
	<b>4</b> <b>4a</b>	Tinned Nickel-plated	B B	<b>3NG1 503</b> <b>3NG1 505</b>		1 1	6 1/5	014 014	0.708 0.730
	<b>With non-insulated grip lugs</b>								

\* You can order this quantity or a multiple thereof.

## Overview

SITOR fuses protect power semiconductors from the effects of a short circuit because the super-quick disconnect characteristic is far quicker than that of conventional LV HRC (NH type) fuse systems. They protect expensive devices and system components such as converters with fuses in the input and in the DC link, UPS systems and soft starters for motors.

Panel mounting requirements have given rise to various connection versions and designs.

The fuses with blade contacts comply with IEC 60269-2 and are suitable for installation in LV HRC fuse bases, in LV HRC fuse switch disconnectors and in switch disconnectors with fuses. They also include fuses with slotted blade contacts for screw fixing with 110 mm mounting dimension, whose sizes comply with IEC 60269-4.

Fuses with slotted blade contacts for screw fixing with 80 mm or 110 mm mounting dimension are often screwed directly onto busbars for optimum heat dissipation. Even better heat transmission is provided by the compact fuses with M10 or M12 female thread, which are also mounted directly onto busbars.

Bolt-on links with 80 mm mounting dimension are another panel-mounting version for direct busbar mounting.

The fuses for SITOR thyristor sets, railway rectifiers or electrolysis systems were developed specially for these applications.

To find out which LV HRC fuse bases and safety switching devices can be used with the SITOR fuses, please refer to the chapter "Low-voltage fuse systems".

Fuse characteristic curves, configuration notes and the assignment of SITOR fuses to 3NP and 3KL fuse bases and safety switching devices can be found in catalog ET B1 Add-On Fuse Characteristic Curves and Configuration Notes and on the Internet.

The new type ranges for size 3 have a round rather than square ceramic body. These series are characterized by small  $I^2t$  values with low power dissipation and high capability under alternating load. The dimensions and functional dimensions correspond to the current standards IEC 60269-4/EN 60269-4 (VDE 0636-4).

### Note:

*The ordering data of the fuses are listed in ascending order of the rated voltage in the selection tables.*

## Benefits

- SITOR fuses have a high varying load factor, which ensures a high level of operational reliability and plant availability - even when subject to constant load change.
- The use of SITOR fuses in LV HRC fuse bases or Siemens switch disconnectors has been tested with regard to heat dissipation and maximum current loading. This makes planning and dimensioning easier and prevents consequential damage.
- Our high standard of quality ensures good compliance with the characteristic curve and accuracy. This ensures long-term protection of devices.

## Operational classes







Fuses are categorized according to function and operational classes. SITOR semiconductor fuses, in LV HRC design, are available in the following operational classes:

- aR: for the short-circuit protection of power semiconductors (partial range protection)
- gR: for the protection of power semiconductors (full range protection)
- gS: The gS operational class combines cable and line protection with semiconductor protection (full range protection).

# BETA Protecting SITOR Semiconductor Fuses

## SITOR, LV HRC design



### Selection and ordering data

Size	$I_e$	$U_e$	Operational class	Breaking $I^2t$ value	Power loss	Varying load factor	DT	Order No.	Price per PU	PU	PS*	PG	Weight per PU approx.	
A	V AC			A <sup>2</sup> s	W	WL				Unit(s)	Unit(s)		kg	
<b>SITOR, LV HRC design</b>														
With slotted blade contacts for M10 screw fixing, mounting dimension: 110 mm, or for installation in LV HRC fuse bases or fuse switch disconnectors														
	3	150	500	gR	33000	35	0.85	B	<b>3NC2 423-3C</b>		1	3	047	0.940
		200			64000	40	0.85	B	<b>3NC2 425-3C</b>		1	3	047	0.940
		250			99000	50	0.85	B	<b>3NC2 427-3C</b>		1	3	047	0.940
		300			132000	65	0.85	B	<b>3NC2 428-3C</b>		1	3	047	0.940
		350	aR		249000	60	0.85	B	<b>3NC2 431-3C</b>		1	3	047	0.940
		400			390000	50	0.85	B	<b>3NC2 432-3C</b>		1	3	047	0.940
With slotted blade contacts with two M10 oblong slots, or for installation in LV HRC fuse bases or fuse switch disconnectors														
	3	150	500	gR	33000	35	0.85	D	<b>3NC2 423-0C</b>		1	3	047	0.940
		200			64000	40	0.85	D	<b>3NC2 425-0C</b>		1	3	047	0.940
		250			99000	50	0.85	D	<b>3NC2 427-0C</b>		1	3	047	0.940
		300			132000	65	0.85	D	<b>3NC2 428-0C</b>		1	3	047	0.940
		350	aR		249000	60	0.85	C	<b>3NC2 431-0C</b>		1	3	047	0.940
		400			390000	50	0.85	D	<b>3NC2 432-0C</b>		1	3	047	0.940
With blade contacts for mounting in LV HRC fuse bases or switch disconnectors														
	3	710	600	gR	2460000	65	1.0	D	<b>3NE1 437-1</b>		1	3	047	1.120
		800			3350000	72	1.0	B	<b>3NE1 438-1</b>		1	3	047	1.113
With slotted blade contacts for M10 screw fixing, mounting dimension: 110 mm, or for installation in LV HRC fuse bases or fuse switch disconnectors														
	3	150	690	gR	17600	40	0.85	B	<b>3NC8 423-3C</b>		1	3	047	0.940
		200			38400	55	0.85	B	<b>3NC8 425-3C</b>		1	3	047	0.940
		250			70400	72	0.85	B	<b>3NC8 427-3C</b>		1	3	047	0.940
		350			176000	95	0.85	B	<b>3NC8 431-3C</b>		1	3	047	0.940
		500			448000	130	0.85	B	<b>3NC8 434-3C</b>		1	3	047	0.940
		1000	aR		2480000	140	0.9	C	<b>3NC8 444-3C</b>		1	3	047	0.940
With slotted blade contacts for M10 screw fixing, mounting dimension: 110 mm, or for installation in LV HRC fuse bases or fuse switch disconnectors														
	1	160	690	gR	18600	30	1.0	B	<b>3NE1 224-3</b>		1	3	047	0.610
		200			51800	28	1.0	B	<b>3NE1 225-3</b>		1	3	047	0.610
		250			80900	35	1.0	B	<b>3NE1 227-3</b>		1	3	047	0.610
		315			168000	42	1.0	B	<b>3NE1 230-3</b>		1	3	047	0.610
With slotted blade contacts for M10 screw fixing, mounting dimension: 110 mm, or for installation in LV HRC fuse bases or fuse switch disconnectors														
	2	350	690	gR	177000	44	1.0	B	<b>3NE1 331-3</b>		1	3	047	0.750
		400			224000	54	1.0	B	<b>3NE1 332-3</b>		1	3	047	0.750
		450			276500	62	1.0	B	<b>3NE1 333-3</b>		1	3	047	0.750
		500			398000	65	1.0	B	<b>3NE1 334-3</b>		1	3	047	0.750

\* You can order this quantity or a multiple thereof.

# BETA Protecting SITOR Semiconductor Fuses







## SITOR, LV HRC design

Size	$I_e$	$U_e$	Operational class	Breaking $I^2t$ value	Power loss	Varying load factor	DT	Order No.	Price per PU	PU	PS*	PG	Weight per PU approx.	
A		V AC		A <sup>2</sup> s	W	WL				Unit(s)	Unit(s)		kg	
<b>SITOR, LV HRC design</b>														
With slotted blade contacts for M12 screw fixing, mounting dimension: 110 mm, or for installation in LV HRC fuse bases or fuse switch disconnectors														
	3	560	690	gR	890000	60	1.0	B	<b>3NE1 435-3</b>		1	3	047	1.150
		630			1390000	62	1.0	B	<b>3NE1 436-3</b>		1	3	047	1.150
		670			1640000	65	1.0	B	<b>3NE1 447-3</b>		1	3	047	1.150
		710			1818000	72	1.0	B	<b>3NE1 437-3</b>		1	3	047	1.150
		800			2475000	82	1.0	B	<b>3NE1 438-3</b>		1	3	047	1.150
		850			3640000	76	1.0	B	<b>3NE1 448-3</b>		1	3	047	1.150
With slotted blade contacts with two oblong slots for M10 screw fixing, or for installation in LV HRC fuse bases or switch disconnectors														
	3	150	690	gR	17600	40	0.85	B	<b>3NC8 423-0C</b>		1	3	047	0.940
		200			38400	55	0.85	B	<b>3NC8 425-0C</b>		1	3	047	0.940
		250			70400	72	0.85	B	<b>3NC8 427-0C</b>		1	3	047	0.940
		350			176000	95	0.85	B	<b>3NC8 431-0C</b>		1	3	047	0.940
		500			448000	130	0.85	B	<b>3NC8 434-0C</b>		1	3	047	0.940
<b>SITOR, LV HRC design</b>														
With M8 bolt-on links, mounting dimension: 80 mm, for screwing onto busbars														
	000	20	690/ 700 <sup>1)</sup>	gR	83	7	0.9	B	<b>3NE8 714-1</b>		1	10	047	0.130
		25			140	9	0.9	B	<b>3NE8 715-1</b>		1	10	047	0.130
		32			285	10	0.9	A	<b>3NE8 701-1</b>		1	10	047	0.131
		40			490	12	0.9	A	<b>3NE8 702-1</b>		1	10	047	0.131
		50			815	15	0.9	A	<b>3NE8 717-1</b>		1	10	047	0.132
		63		aR	1550	16	0.95	A	<b>3NE8 718-1</b>		1	10	047	0.132
		80			2700	18	0.9	▶	<b>3NE8 720-1</b>		1	10	047	0.131
		100			4950	19	0.95	▶	<b>3NE8 721-1</b>		1	10	047	0.130
		125			9100	23	0.95	▶	<b>3NE8 722-1</b>		1	10	047	0.131
		160			17000	31	0.9	▶	<b>3NE8 724-1</b>		1	10	047	0.132
		200			30000	36	0.9	▶	<b>3NE8 725-1</b>		1	10	047	0.130
		250			55000	42	0.9	▶	<b>3NE8 727-1</b>		1	10	047	0.133
		315			85500	54	0.85	▶	<b>3NE8 731-1</b>		1	10	047	0.134

<sup>1)</sup> DC voltages according to UL.

# BETA Protecting SITOR Semiconductor Fuses

## SITOR, LV HRC design

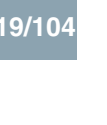



Size	$I_e$	$U_e$	Operational class	Breaking $I_t$ value	Power loss	Varying load factor	DT	Order No.	Price per PU	PU	PS*	PG	Weight per PU approx.		
A	VAC			A <sup>2</sup> s	W	WL				Unit(s)	Unit(s)		kg		
<b>SITOR, LV HRC design</b>															
With blade contacts for mounting in LV HRC fuse bases or switch disconnectors															
	000	16	690	gS	200	3.0	1.0	▶	<b>3NE1 813-0</b>		1	3	047	0.127	
		20			430	3.5	1.0	▶▶	<b>3NE1 814-0</b>		1	3	047	0.128	
		25			780	4.0	1.0	▶	<b>3NE1 815-0</b>		1	3	047	0.127	
		35			1700	5.0	1.0	▶	<b>3NE1 803-0</b>		1	3	047	0.128	
		40			3000	5.0	1.0	▶▶	<b>3NE1 802-0</b>		1	3	047	0.127	
		50			4400	6.0	1.0	▶▶	<b>3NE1 817-0</b>		1	3	047	0.128	
		63			9000	7.0	1.0	▶▶	<b>3NE1 818-0</b>		1	3	047	0.128	
		80			18000	8.0	1.0	▶▶	<b>3NE1 820-0</b>		1	3	047	0.129	
	00	100	690	gS	33000	10	1.0	▶	<b>3NE1 021-0</b>		1	3	047	0.202	
		125			63000	11	1.0	▶	<b>3NE1 022-0</b>		1	3	047	0.202	
	1	160	690	gS	60000	24	1.0	▶	<b>3NE1 224-0</b>		1	3	047	0.580	
		200			100000	27	1.0	▶▶	<b>3NE1 225-0</b>		1	3	047	0.582	
		250			200000	30	1.0	▶▶	<b>3NE1 227-0</b>		1	3	047	0.580	
		315			310000	38	1.0	A	<b>3NE1 230-0</b>		1	3	047	0.581	
	2	350	690	gS	430000	42	1.0	▶	<b>3NE1 331-0</b>		1	3	047	0.766	
		400			590000	45	1.0	▶▶	<b>3NE1 332-0</b>		1	3	047	0.743	
		450			750000	53	1.0	A	<b>3NE1 333-0</b>		1	3	047	0.760	
		500			950000	56	1.0	A	<b>3NE1 334-0</b>		1	3	047	0.766	
		3	560	690	gS	1700000	50	1.0	A	<b>3NE1 435-0</b>		1	3	047	1.111
			630			2350000	55	1.0	A	<b>3NE1 436-0</b>		1	3	047	1.114
			710			3400000	60	1.0	A	<b>3NE1 437-0</b>		1	3	047	1.117
			800			5000000	59	1.0	A	<b>3NE1 438-0</b>		1	3	047	1.124
	00	80	690	gR	5800	10.5	1.0	A	<b>3NE1 020-2</b>		1	3	047	0.203	
		100			11000	11.5	1.0	A	<b>3NE1 021-2</b>		1	3	047	0.203	
		125			23000	13.5	1.0	A	<b>3NE1 022-2</b>		1	3	047	0.203	
	1	160	690	gR	18600	30	1.0	A	<b>3NE1 224-2</b>		1	3	047	0.613	
		200			51800	28	1.0	A	<b>3NE1 225-2</b>		1	3	047	0.612	
		250			80900	35	1.0	A	<b>3NE1 227-2</b>		1	3	047	0.626	
		315			168000	42	1.0	A	<b>3NE1 230-2</b>		1	3	047	0.615	
	2	350	690	gR	177000	44	1.0	A	<b>3NE1 331-2</b>		1	3	047	0.754	
		400			224000	54	1.0	B	<b>3NE1 332-2</b>		1	3	047	0.760	
		450			276500	62	1.0	A	<b>3NE1 333-2</b>		1	3	047	0.768	
		500			398000	65	1.0	A	<b>3NE1 334-2</b>		1	3	047	0.768	
	3	560	690	gR	890000	60	1.0	A	<b>3NE1 435-2</b>		1	3	047	1.149	
		630			1390000	62	1.0	A	<b>3NE1 436-2</b>		1	3	047	1.179	
		670			1640000	65	1.0	A	<b>3NE1 447-2</b>		1	3	047	1.170	
		710			1818000	72	1.0	B	<b>3NE1 437-2</b>		1	3	047	1.153	
		800			2475000	82	1.0	A	<b>3NE1 438-2</b>		1	3	047	1.184	
		850			3640000	76	1.0	A	<b>3NE1 448-2</b>		1	3	047	1.207	

\* You can order this quantity or a multiple thereof.



# BETA Protecting SITOR Semiconductor Fuses







## SITOR, LV HRC design

Size	$I_e$	$U_e$	Operational class	Breaking $I^2t$ value	Power loss	Varying load factor	DT	Order No.	Price per PU	PU	PS*	PG	Weight per PU approx.	
A	V AC			A <sup>2</sup> s	W	WL				Unit(s)	Unit(s)		kg	
<b>SITOR, LV HRC design</b>														
With blade contacts for mounting in LV HRC fuse bases or fuse switch disconnectors (contd.)														
	00	25	690	gR	180	7	0.95	▶	<b>3NE8 015-1</b>		1	3	047	0.205
		35			400	9	0.95	▶	<b>3NE8 003-1</b>		1	3	047	0.204
		50			700	14	0.95	▶	<b>3NE8 017-1</b>		1	3	047	0.203
		63			1400	16	0.95	▶	<b>3NE8 018-1</b>		1	3	047	0.205
		80		aR	2400	19	0.95	▶	<b>3NE8 020-1</b>		1	3	047	0.203
		100			4200	22	0.95	▶	<b>3NE8 021-1</b>		1	3	047	0.205
		125			6500	28	0.95	▶	<b>3NE8 022-1</b>		1	3	047	0.213
		160			13000	38	0.95	▶	<b>3NE8 024-1</b>		1	3	047	0.207
With slotted blade contacts for M12 screw fixing, mounting dimension: 80 mm														
	3	630	690	aR	244000	120	0.85	C	<b>3NC3 236-1</b>		1	3	047	0.785
		710			346000	130	0.85	D	<b>3NC3 237-1</b>		1	3	047	0.785
		800			498000	135	0.9	C	<b>3NC3 238-1</b>		1	3	047	0.785
		900			677000	145	0.9	D	<b>3NC3 240-1</b>		1	3	047	0.785
		1000			975000	155	0.95	C	<b>3NC3 241-1</b>		1	3	047	0.785
		1100			1382000	165	0.95	D	<b>3NC3 242-1</b>		1	3	047	0.785
		1250			1990000	175	0.95	C	<b>3NC3 243-1</b>		1	3	047	0.785
		1400	500		2100000	200	0.95	D	<b>3NC3 244-1</b>		1	3	047	0.785
	1600			2860000	240	0.9	D	<b>3NC3 245-1</b>		1	3	047	0.785	
With M12 female thread at both ends for direct busbar mounting														
	3	630	690	aR	244000	125	0.9	C	<b>3NC3 236-6</b>		1	3	047	0.765
		710			346000	130	0.9	D	<b>3NC3 237-6</b>		1	3	047	0.765
		800			498000	135	0.95	C	<b>3NC3 238-6</b>		1	3	047	0.765
		900			677000	140	0.95	D	<b>3NC3 240-6</b>		1	3	047	0.765
		1000			975000	145	1.0	C	<b>3NC3 241-6</b>		1	3	047	0.765
		1100			1382000	150	1.0	D	<b>3NC3 242-6</b>		1	3	047	0.765
		1250			1990000	155	1.0	C	<b>3NC3 243-6</b>		1	3	047	0.765
		1400	500		2100000	175	1.0	C	<b>3NC3 244-6</b>		1	3	047	0.765
	1600			2860000	195	0.95	C	<b>3NC3 245-6</b>		1	3	047	0.765	
With slotted blade contacts for M10 screw fixing, mounting dimension: 110 mm, or for installation in LV HRC fuse bases or fuse switch disconnectors														
	2	250	800	aR	29700	105	0.85	▶	<b>3NE4 327-0B</b>		1	3	047	0.753
		315			60700	120	0.85	▶	<b>3NE4 330-0B</b>		1	3	047	0.760
		450			191000	140	0.85	▶	<b>3NE4 333-0B</b>		1	3	047	0.760
		500			276000	155	0.85	▶	<b>3NE4 334-0B</b>		1	3	047	0.754
		710			923000	155	0.85	▶	<b>3NE4 337</b>		1	3	047	0.771
With blade contacts for mounting in LV HRC fuse bases or switch disconnectors														
	0	32	1000	gR	280	12	0.9	▶	<b>3NE4 101</b>		1	3	047	0.278
		40			500	13	0.9	▶	<b>3NE4 102</b>		1	3	047	0.277
		50			800	16	0.9	▶	<b>3NE4 117</b>		1	3	047	0.276
		63		aR	1500	20	0.9	▶	<b>3NE4 118</b>		1	3	047	0.279
		80			3000	22	0.9	▶	<b>3NE4 120</b>		1	3	047	0.276
		100			6000	24	0.9	▶	<b>3NE4 121</b>		1	3	047	0.278
		125			14000	30	0.9	▶	<b>3NE4 122</b>		1	3	047	0.279
		160			29000	35	0.9	▶	<b>3NE4 124</b>		1	3	047	0.279

\* You can order this quantity or a multiple thereof.

# BETA Protecting SITOR Semiconductor Fuses







## SITOR, LV HRC design

Size	$I_e$	$U_e$	Operational class	Breaking $I^2t$ value	Power loss	Varying load factor	DT	Order No.	Price per PU	PU	PS*	PG	Weight per PU approx.	
A	VAC			A <sup>2</sup> s	W	WL				Unit(s)	Unit(s)		kg	
<b>SITOR, LV HRC design</b>														
With slotted blade contacts for M10 screw fixing, mounting dimension: 110 mm, or for installation in LV HRC fuse bases or fuse switch disconnectors														
	1	100	1000	aR	4800	28	0.95	A	<b>3NE3 221</b>		1	3	047	0.580
		125			7200	36	0.95	A	<b>3NE3 222</b>		1	3	047	0.568
		160			13000	42	0.95	▶	<b>3NE3 224</b>		1	3	047	0.573
		200			30000	42	0.95	▶	<b>3NE3 225</b>		1	3	047	0.570
		250			48000	50	0.95	▶	<b>3NE3 227</b>		1	3	047	0.580
		315			80000	65	0.95	▶	<b>3NE3 230-0B</b>		1	3	047	0.585
		350			100000	75	0.9	A	<b>3NE3 231</b>		1	3	047	0.590
		400			135000	85	0.9	A	<b>3NE3 232-0B</b>		1	3	047	0.576
		450			175000	95	0.9	▶	<b>3NE3 233</b>		1	3	047	0.720
		2	400	1000	aR	135000	85	1.0	A	<b>3NE3 332-0B</b>		1	3	047
		450			175000	90	1.0	A	<b>3NE3 333</b>		1	3	047	0.748
		500			260000	90	1.0	▶	<b>3NE3 334-0B</b>		1	3	047	0.753
		560			360000	95	1.0	▶	<b>3NE3 335</b>		1	3	047	0.756
		630			600000	100	1.0	▶	<b>3NE3 336</b>		1	3	047	0.760
		710	900	aR	800000	105	1.0	▶	<b>3NE3 337-8</b>		1	3	047	0.762
		800	800		850000	130	0.95	▶	<b>3NE3 338-8</b>		1	3	047	0.764
		900	690		920000	165	0.95	▶	<b>3NE3 340-8</b>		1	3	047	0.753
With slotted blade contacts for M10 screw fixing, mounting dimension: 130 mm														
		3	100	1000	aR	13500	25	1.0	D	<b>3NE3 421-0C</b>		1	3	047
		224			54000	85	1.0	B	<b>3NE3 626-0C</b>		1	3	047	1.120
		315			218000	80	1.0	B	<b>3NE3 430-0C</b>		1	3	047	1.120
		400			364000	110	1.0	B	<b>3NE3 432-0C</b>		1	3	047	1.120
		450			488000	110	1.0	B	<b>3NE3 635-0C</b>		1	3	047	1.120
		500			870000	95	1.0	B	<b>3NE3 434-0C</b>		1	3	047	1.120
		630			1280000	132	1.0	D	<b>3NE3 636-0C</b>		1	3	047	1.120
		710			1950000	145	1.0	D	<b>3NE3 637-0C</b>		1	3	047	1.120
With M10 female thread at both ends for direct mounting on busbars														
	3	450	1000	aR	488000	110	1.0	D	<b>3NE3 635-6</b>		1	3	047	1.184
With slotted blade contacts for M12 screw fixing, mounting dimension: 140 mm														
	3	710	1000	aR	1950000	145	1.0	D	<b>3NE3 637-1C</b>		1	3	047	1.120
With slotted blade contacts for M12 screw fixing, mounting dimension: 110 mm, or for installation in LV HRC fuse bases or fuse switch disconnectors														
	3	630	1000	aR	418000	145	0.85	C	<b>3NC3 336-1</b>		1	3	047	1.020
		710			569000	150	0.85	D	<b>3NC3 337-1</b>		1	3	047	1.020
		800			819000	155	0.85	C	<b>3NC3 338-1</b>		1	3	047	1.020
		900			1160000	165	0.9	D	<b>3NC3 340-1</b>		1	3	047	1.020
		1000			1670000	170	0.9	C	<b>3NC3 341-1</b>		1	3	047	1.020
		1100	800		1910000	185	0.9	D	<b>3NC3 342-1</b>		1	3	047	1.020
		1250			2600000	210	0.9	D	<b>3NC3 343-1</b>		1	3	047	1.020

\* You can order this quantity or a multiple thereof.

# BETA Protecting SITOR Semiconductor Fuses







## SITOR, LV HRC design

Size	$I_e$	$U_e$	Operational class	Breaking $I^2t$ value	Power loss	Varying load factor	DT	Order No.	Price per PU	PU	PS*	PG	Weight per PU approx.	
A	V AC			A <sup>2</sup> s	W	WL				Unit(s)	Unit(s)		kg	
<b>SITOR, LV HRC design</b>														
With M12 female thread at both ends for direct busbar mounting														
	3	630	1000	aR	418000	130	0.90	C	<b>3NC3 336-6</b>		1	3	047	0.980
		710			569000	140	0.90	D	<b>3NC3 337-6</b>		1	3	047	0.980
		800			819000	150	0.90	C	<b>3NC3 338-6</b>		1	3	047	0.980
		900			1160000	160	0.95	D	<b>3NC3 340-6</b>		1	3	047	0.980
		1000			1670000	165	0.95	C	<b>3NC3 341-6</b>		1	3	047	0.980
		1100	800		1910000	175	0.95	D	<b>3NC3 342-6</b>		1	3	047	0.980
	1250			2600000	185	0.95	C	<b>3NC3 343-6</b>		1	3	047	0.980	
With slotted blade contacts for M12 screw fixing, mounting dimension: 110 mm														
	3	315	1250	aR	72500	80	0.95	B	<b>3NC3 430-1</b>		1	3	047	0.950
		400			163000	95	0.95	B	<b>3NC3 432-1</b>		1	3	047	0.950
		500			290000	115	0.90	B	<b>3NC3 434-1</b>		1	3	047	0.950
		630			650000	120	0.95	B	<b>3NC3 436-1</b>		1	3	047	0.950
		800	1100		985000	145	0.90	B	<b>3NC3 438-1</b>		1	3	047	1.150
With M12 female thread at both ends for direct busbar mounting														
	3	315	1250	aR	72500	80	0.95	B	<b>3NC3 430-6</b>		1	3	047	0.910
		400			163000	95	0.95	B	<b>3NC3 432-6</b>		1	3	047	0.910
		500			290000	115	0.90	B	<b>3NC3 434-6</b>		1	3	047	0.910
		630			650000	120	0.95	B	<b>3NC3 436-6</b>		1	3	047	0.910
		800	1100		985000	145	0.95	B	<b>3NC3 438-6</b>		1	3	047	1.110
With slotted blade contacts for M10 screw fixing, mounting dimension: 210 mm														
	3	160	1500	aR	54000	56	1.0	D	<b>3NE5 424-0C</b>		1	2	047	1.860
		224			138000	80	1.0	C	<b>3NE5 426-0C</b>		1	2	047	1.860
		315			311000	115	1.0	D	<b>3NE5 430-0C</b>		1	2	047	1.860
		350			428000	135	1.0	D	<b>3NE5 431-0C</b>		1	2	047	1.860
		450			870000	145	0.95	D	<b>3NE5 433-0C</b>		1	2	047	1.860
		450			870000	145	0.95	D	<b>3NE5 433-1C</b>		1	2	047	1.860
With slotted blade contacts for M10 screw fixing, mounting dimension: 170 mm														
	3	250	1500	aR	84000	130	1.0	D	<b>3NE5 627-0C</b>		1	3	047	1.520
		450			590000	160	1.0	B	<b>3NE5 633-0C</b>		1	3	047	1.520
		600			1950000	145	1.0	D	<b>3NE5 643-0C</b>		1	3	047	1.520
With slotted blade contacts for M10 screw fixing, mounting dimension: 210 mm														
	3	200	2000	aR	138000	75	1.0	D	<b>3NE7 425-0C</b>		1	2	047	1.860
		250			218000	110	1.0	D	<b>3NE7 427-0C</b>		1	2	047	1.860
		350			555000	120	1.0	D	<b>3NE7 431-0C</b>		1	2	047	1.860
		400			870000	150	1.0	D	<b>3NE7 432-0C</b>		1	2	047	1.860
		450			960000	160	1.0	D	<b>3NE7 633-0C</b>		1	2	047	1.860
		630			1950000	220	1.0	D	<b>3NE7 636-0C</b>		1	2	047	1.860
With slotted blade contacts for M12 screw fixing, mounting dimension: 210 mm														
	3	450	2000	aR	960000	160	1.0	C	<b>3NE7 633-1C</b>		1	2	047	1.860
		525			1120000	210	1.0	D	<b>3NE7 648-1C</b>		1	2	047	1.860
		630			1950000	220	1.0	C	<b>3NE7 636-1C</b>		1	1	047	1.860
		710			3110000	275	1.0	B	<b>3NE7 637-1C</b>		1	2	047	1.860

\* You can order this quantity or a multiple thereof.

# BETA Protecting SITOR Semiconductor Fuses

## SITOR, LV HRC design

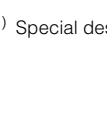
	Size	$I_e$	$U_e$	Operational class	Breaking $I^2t$ value	Power loss	Varying load factor	DT	Order No.	Price per PU	PU	PS*	PG	Weight per PU approx.
	A	V	VAC		A <sup>2</sup> s	W	WL				Unit(s)	Unit(s)		kg
<b>SITOR, LV HRC design</b>														
	With slotted blade contacts for M12 screw fixing, mounting dimension: 260 mm													
	3	400	2500	aR	620,000	250	1.0	D	<b>3NE9 632-1C</b>		1	1	047	2.350
		500			1,270,000	235	1.0	D	<b>3NE9 634-1C</b>		1	1	047	2.350
		630			2,800,000	275	1.0	D	<b>3NE9 636-1C</b>		1	1	047	2.350
<b>Fuses for special applications</b>														
For screwing onto water-cooled busbars, for rectifiers in electrolysis systems														
	-- <sup>1)</sup>	350	800	aR	260,000	80	0.9	X	<b>3NC5 531</b>		1	3	047	0.671
		600	1000		888,000	150	0.9	D	<b>3NC5 840</b>		1	3	047	1.408
		630	800		888,000	145	0.9	C	<b>3NC5 841</b>		1	3	047	1.185
		800	1000		1,728,000	170	0.9	D	<b>3NC5 838</b>		1	3	047	1.196
		710	900		620,000	150	0.9	D	<b>3NE6 437-7</b>		1	3	047	1.168
		1250	600		2,480,000	210	0.9	D	<b>3NE9 450-7</b>		1	3	047	1.245
With M10 female thread at both ends for direct busbar mounting, for air-cooled rectifiers in electrolysis systems														
	-- <sup>1)</sup>	710	900	gR	620,000	150	0.9	D	<b>3NE6 437</b>		1	3	047	1.093
		850	600		2,480,000	85	1.0	D	<b>3NE9 440-6</b>		1	3	047	1.082
		900	900	aR	1,920,000	170	0.9	C	<b>3NE6 444</b>		1	3	047	1.175
		1250	600		2,480,000	210	0.9	D	<b>3NE9 450</b>		1	3	047	1.114
Fuse with installation holder for SITOR 6QG10 thyristor sets														
	--	200	1000	aR	44,000	50	0.85	D	<b>3NE3 525-5</b>		1	2	047	0.744
		450			395,000	90	0.85	D	<b>3NE3 535-5</b>		1	2	047	0.746
Fuse with installation holder for SITOR 6QG11 thyristor sets														
	-- <sup>1)</sup>	50	1000	gR	1,100	20	0.85	C	<b>3NE4 117-5</b>		1	2	047	0.303
		100		aR	7,400	35	0.85	B	<b>3NE4 121-5</b>		1	2	047	0.309
		170		aR	60,500	43	0.85	B	<b>3NE4 146-5</b>		1	2	047	0.311
Fuse female thread at both ends for SITOR 6QG12 thyristor sets														
	-- <sup>1)</sup>	250	800	aR	29,700	105	0.85	▶	<b>3NE4 327-6B</b>		1	3	047	0.692
		315			60,700	120	0.85	▶	<b>3NE4 330-6B</b>		1	3	047	0.688
		450			191,000	140	0.85	▶	<b>3NE4 333-6B</b>		1	3	047	0.690
		500			276,000	155	0.85	▶	<b>3NE4 334-6B</b>		1	3	047	0.688
		710			923,000	155	0.95	▶	<b>3NE4 337-6</b>		1	3	047	0.689
With M12 female thread at both ends for direct busbar mounting for railway supply rectifiers														
	-- <sup>1)</sup>	250	680	aR	635,000	25	0.9	D	<b>3NC7 327-2</b>		1	3	047	0.725
		350			1,430,000	32	0.9	D	<b>3NC7 331-2</b>		1	3	047	0.740

<sup>1)</sup> Special design.

\* You can order this quantity or a multiple thereof.

# BETA Protecting SITOR Semiconductor Fuses

## SITOR, cylindrical fuse design

### Overview

SITOR cylindrical fuses protect power semiconductors against the effects of short circuits because the super quick disconnect characteristic is far quicker than that of conventional fuses. They protect expensive devices and system components such as solid-state contactors, electronic relays (solid state), converters with fuses in the input and in the DC link, UPS systems and soft starters for motors up to 100 A.

The cylindrical design is approved for industrial applications. The cylindrical fuse links comply with IEC 60269.

Cylindrical fuse holders also comply with IEC 60269 and UL 512. The cylindrical fuse holders for 10 x 38 mm and 14 x 51 mm have been tested and approved as fuse switch disconnectors and the cylindrical fuse holders for 22 x 58 mm as fuse disconnectors according to the switching device standard IEC 60947-3. The utilization category and the tested current and voltage values are specified in the Table "Technical Specifications".

The cylindrical fuse holders have been specially developed for the application of SITOR fuse links with regard to heat tolerance and heat dissipation and are therefore not recommended for standard applications.

Cylindrical fuse bases do not offer the same comprehensive touch protection as the fuse holders, but have better heat dissipation. The single-pole cylindrical fuse bases for 14 x 51 mm and 22 x 58 mm allow modular expansion to multipole bases.

### Benefits

- Cylindrical fuses have an extremely compact design and a correspondingly small footprint
- The cylindrical fuses have IEC and UL approval and are suitable for universal use worldwide.
- The use of SITOR cylindrical fuses in the cylindrical fuse holders and bases has been tested with regard to heat dissipation and maximum current loading. This makes planning and dimensioning easier and prevents consequential damage.
- The use of fuse holders as switch disconnectors expands the area of application of these devices and increases operating safety.

### Selection and ordering data

Size	$I_e$	$U_e$	Breaking $I^2t$ value	Power loss	DT	Order No.	Price per PU	PU	PS*	PG	Weight per PU approx.
mm x mm	A	V AC/ V DC	A <sup>2</sup> s	W				Unit(s)	Unit(s)		kg
<b>Cylindrical fuse links, operational class aR</b>											
	10 x 38	3	600/400	8	1.2	A	<b>3NC1 003</b>	1	10	047	0.009
				20	1.5	▶	<b>3NC1 006</b>	1	10	047	0.009
				30	2	B	<b>3NC1 008</b>	1	10	047	0.009
				60	2.5	▶	<b>3NC1 010</b>	1	10	047	0.009
				110	3	B	<b>3NC1 012</b>	1	10	047	0.009
				150	3.5	▶	<b>3NC1 016</b>	1	10	047	0.009
				200	4.8	▶	<b>3NC1 020</b>	1	10	047	0.009
				250	6	▶	<b>3NC1 025</b>	1	10	047	0.009
				500	7.5	▶	<b>3NC1 032</b>	1	10	047	0.009
				14 x 51	1	660/700 <sup>1)</sup>	1.2	5	B	<b>3NC1 401</b>	1
10	3	▶	<b>3NC1 402</b>				1	10	047	0.020	
15	2.5	B	<b>3NC1 403</b>				1	10	047	0.020	
25	3	▶	<b>3NC1 404</b>				1	10	047	0.020	
690/700 <sup>1)</sup>	9	1.5	B				<b>3NC1 405</b>	1	10	047	0.020
	12	1.5	▶				<b>3NC1 406</b>	1	10	047	0.020
20	4	▶	<b>3NC1 410</b>				1	10	047	0.020	
75	5.5	▶	<b>3NC1 415</b>				1	10	047	0.020	
120	6	▶	<b>3NC1 420</b>				1	10	047	0.020	
250	7	▶	<b>3NC1 425</b>				1	10	047	0.020	
300	9	B	<b>3NC1 430</b>				1	10	047	0.020	
700	7.6	▶	<b>3NC1 432</b>				1	10	047	0.021	
900	8	▶	<b>3NC1 440</b>				1	10	047	0.021	
1800	9	▶	<b>3NC1 450</b>				1	10	047	0.021	
22 x 58	20	690/700 <sup>1)</sup>	220				4.6	B	<b>3NC2 220</b>	1	5
			300	5.6	B	<b>3NC2 225</b>	1	5	047	0.056	
			450	7	B	<b>3NC2 232</b>	1	5	047	0.056	
			700	8.5	B	<b>3NC2 240</b>	1	5	047	0.056	
			1350	9.5	▶	<b>3NC2 250</b>	1	5	047	0.056	
			2600	11	▶	<b>3NC2 263</b>	1	5	047	0.056	
			5500	13.5	▶	<b>3NC2 280</b>	1	5	047	0.057	
			8000	16	▶	<b>3NC2 200</b>	1	5	047	0.057	
			600/700 <sup>1)</sup>	1500	9.5	B	<b>3NC2 250-5</b>	1	5	047	0.056
				3000	11	B	<b>3NC2 263-5</b>	1	5	047	0.056
				6000	13.5	B	<b>3NC2 280-5</b>	1	5	047	0.057
				8500	16	B	<b>3NC2 200-5</b>	1	5	047	0.057

<sup>1)</sup> DC voltages according to UL.

# BETA Protecting SITOR Semiconductor Fuses

## SITOR, cylindrical fuse design

	Size	$I_e$	$U_e$	Breaking $I^2t$ value	Power loss	DT	Order No.	Price per PU	PU	PS*	PG	Weight per PU approx.
	mm × mm	A	V AC/ V DC	A <sup>2</sup> s	W				Unit(s)	Unit(s)		kg
<b>Cylindrical fuse links with striking pin, operational class aR</b>												
	14 × 51	10	690/700 <sup>1)</sup>	90	4	B	<b>3NC1 410-5</b>		1	10	047	0.020
		15		100	5.5	B	<b>3NC1 415-5</b>		1	10	047	0.020
	22 × 58	20	690/700 <sup>1)</sup>	500	6	B	<b>3NC1 420-5</b>		1	10	047	0.020
		25		400	7	C	<b>3NC1 425-5</b>		1	10	047	0.020
		30		500	9	C	<b>3NC1 430-5</b>		1	10	047	0.020
		32		600	7.6	B	<b>3NC1 432-5</b>		1	10	047	0.020
		40		900	8	B	<b>3NC1 440-5</b>		1	10	047	0.020
		50		2000	9	B	<b>3NC1 450-5</b>		1	10	047	0.020
		20		240	5	C	<b>3NC2 220-5</b>		1	10	047	0.056
		25		350	6	C	<b>3NC2 225-5</b>		1	5	047	0.056
32	500	8	B	<b>3NC2 232-5</b>		1	5	047	0.056			
40	800	9	B	<b>3NC2 240-5</b>		1	5	047	0.056			

<sup>1)</sup> DC voltages according to UL.

	Size	Version	Rated voltage	DT	Order No.	Price per PU	PU	PS*	PG	Weight per PU approx.
	mm × mm		V AC				Unit(s)	Unit(s)		kg
<b>Cylindrical fuse holders</b> Can be used as fuse switch disconnectors/discon. <sup>1)</sup>										
	10 × 38	1P	690	▶	<b>3NC1 091</b>		1	12	047	0.065
		2P		▶	<b>3NC1 092</b>		1	6	047	0.131
		3P		▶	<b>3NC1 093</b>		1	4	047	0.197
	14 × 51	1P	690	▶	<b>3NC1 491</b>		1	6	047	0.125
		2P		▶	<b>3NC1 492</b>		1	3	047	0.233
		3P		B	<b>3NC1 493</b>		1	2	047	0.350
	22 × 58	1P	690	▶	<b>3NC2 291</b>		1	1	047	0.193
		2P		▶	<b>3NC2 292</b>		1	3	047	0.381
		3P		B	<b>3NC2 293</b>		1	2	047	0.584

**Cylindrical fuse holders**  
Can be used as fuse switch disconnectors, with signal-  
ing switches for fuse links with striking pin<sup>1)</sup>



14 × 51	1P	690	B	<b>3NC1 491-5</b>		1	6	047	0.125
22 × 58	1P	690	B	<b>3NC2 291-5</b>		1	6	047	0.193

### Cylindrical fuse bases



10 × 38	1P	600	B	<b>3NC1 038-1</b>		1	10	047	0.042
	2P		C	<b>3NC1 038-2</b>		1	8	047	0.077
	3P		B	<b>3NC1 038-3</b>		1	6	047	0.113
14 × 51	1P	690	B	<b>3NC1 451-1</b>		1	3	047	0.120
22 × 58	1P		B	<b>3NC2 258-1</b>		1	3	047	0.238

### Cylindrical fuse clips

For fuses 10 × 38				C	<b>3NC1 038</b>		1	20	047	0.002
For fuses 14 × 51				B	<b>3NC1 451</b>		1	20	047	0.005

### Fuse tongs



10 × 38, 14 × 51, 22 × 58			B	<b>3NC1 000</b>		1	1	047	0.069
---------------------------------	--	--	---	-----------------	--	---	---	-----	-------

<sup>1)</sup> Please observe the utilization category and current / voltage values specified in the "Technical specifications" table.

\* You can order this quantity or a multiple thereof.

### Overview

SILIZED is the brand name for NEOZED fuses (D0 fuses) and DIAZED fuses (D fuses) with super quick characteristic for semiconductor protection. The fuses are used together with fuse bases, fuse screw caps and accessories of the standard fuse system.

SILIZED fuses protect power semiconductors from the effects of short circuits because the super quick disconnect characteristic is far quicker than that of conventional fuses. They protect expensive devices and system components such as solid-state contactors, static relays, converters with fuses in the input and in the DC link, UPS systems and soft starters for motors up to 100 A.

If using fuse bases and fuse screw caps made of molded plastic, always take into account the maximum permissible values of power loss due to the high power dissipation (power loss) of the SILIZED fuses. If using these components, the following maximum permissible power losses apply:

- NEOZED D02: 5.5 W
- DIAZED DII: 4.5 W
- DIAZED DIII: 7.0 W



For this reason, sometimes a thermal permanent load of only 50 % is possible.

The DIAZED screw adapter DII for 25 A is used for the 30 A fuse link.

### Benefits

- SILIZED fuses have an extremely compact design. This means they have a very small footprint - particularly the NEOZED version
- The rugged and well-known DIAZED design complies with IEC 60269-3. It is globally renowned and can be used in many countries.
- A huge range of fuse bases and accessories are available for the NEOZED and DIAZED versions of the SILIZED fuses. This increases the application options in many devices.

### Selection and ordering data

	Size	$I_e$	$U_e$	Breaking $I^2t$ value	Power loss	DT	Order No.	Price per PU	PU	PS*	PG	Weight per PU approx.
	A		V AC/ V DC	A <sup>2</sup> s	W				Unit(s)	Unit(s)		kg
<b>SILIZED fuse links, NEOZED design operational class gR</b>												
	D01	10	400/250	73	6.9	B	<b>5SE1 310</b>		1	10	016	0.006
		16		120	6.2	B	<b>5SE1 316</b>		1	10	016	0.007
	D02	20		190	8.1	B	<b>5SE1 320</b>		1	10	016	0.012
		25		215	8.2	B	<b>5SE1 325</b>		1	10	016	0.012
		35		470	16.7	B	<b>5SE1 335</b>		1	10	016	0.012
		50		1960	12.0	B	<b>5SE1 350</b>		1	10	016	0.013
		63		4230	15.5	B	<b>5SE1 363</b>		1	10	016	0.014

	Size	$I_e$	$U_e$	Breaking $I^2t$ value	Power loss	DT	Order No.	Price per PU	PU	PS*	PG	Weight per PU approx.
	A		V AC/ V DC	A <sup>2</sup> s	W				Unit(s)	Unit(s)		kg
<b>SILIZED fuse links, DIAZED design operational class gR</b>												
	DII	16	500/500	60	12.1	A	<b>5SD4 20</b>		1	5	016	0.028
		20		139	12.3	A	<b>5SD4 30</b>		1	5	016	0.029
		25		205	12.5	A	<b>5SD4 40</b>		1	5	016	0.031
		30		310	13.5	A	<b>5SD4 80</b>		1	5	016	0.031
	DIII	35	539	14.8	A	<b>5SD4 50</b>		1	5	016	0.050	
		50	1250	18.5	A	<b>5SD4 60</b>		1	5	016	0.051	
		63	1890	28	A	<b>5SD4 70</b>		1	5	016	0.054	
	DIV	80	4200	34.3	B	<b>5SD5 10</b>		1	3	016	0.110	
		100	8450	41.5	B	<b>5SD5 20</b>		1	3	016	0.110	

\* You can order this quantity or a multiple thereof.

# BETA Protecting SR60 Busbar Systems

## Distribution board components

### Overview

The use of busbar systems with their versatile rail-adaptable connection, switching and installation devices is an ideal and cost-effective electrotechnical enhancement of modern distribu-

tion boards due to their small footprint, compact design and quick assembly contacts. Mounting is implemented on longitudinal stays. The busbar spacing is 60 mm.

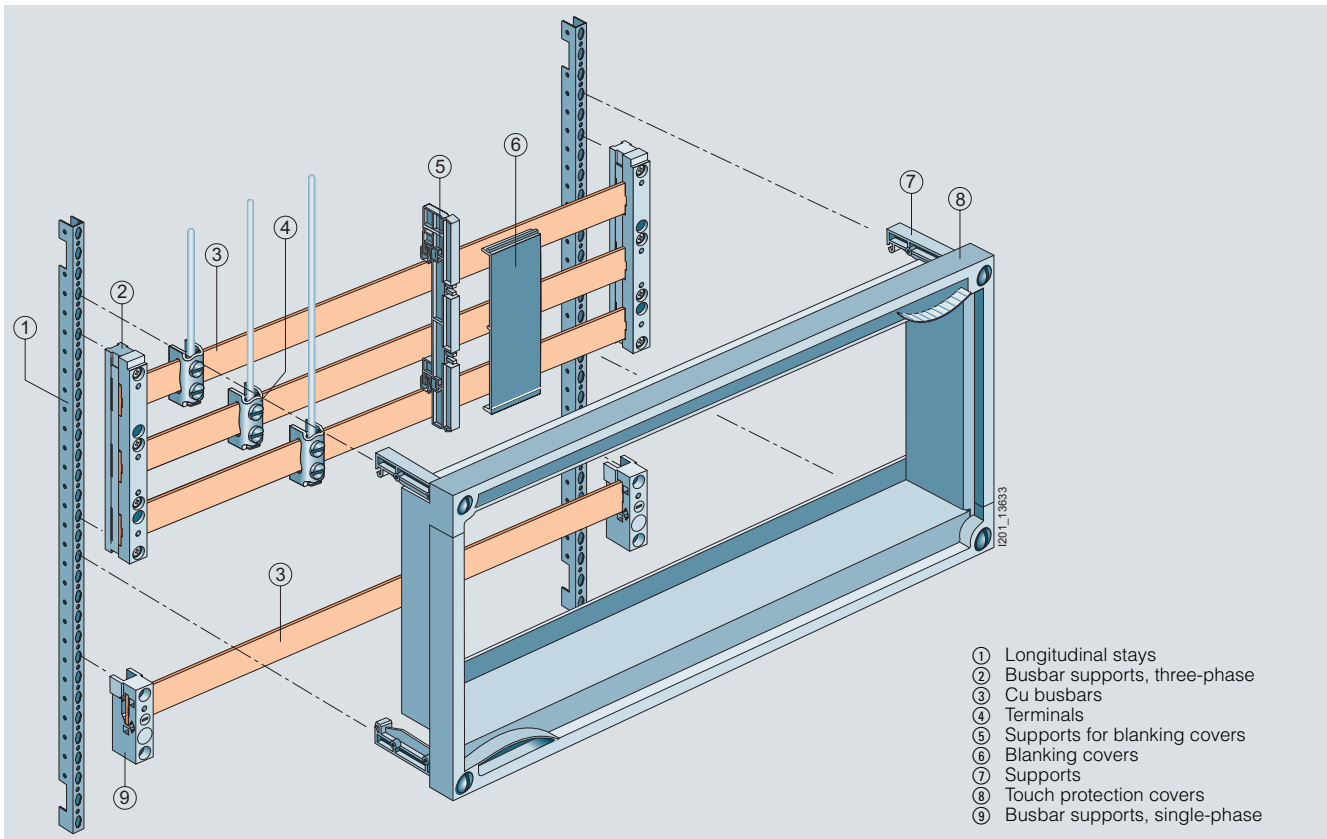





- ① Longitudinal stays
- ② Busbar supports, three-phase
- ③ Cu busbars
- ④ Terminals
- ⑤ Supports for blanking covers
- ⑥ Blanking covers
- ⑦ Supports
- ⑧ Touch protection covers
- ⑨ Busbar supports, single-phase

### Benefits

- Only a few distribution board components are required to ensure the integration of busbars in the distribution board. This saves time and space.
- The touch protection cover is sealable as standard and is quick and easy to attach to the supports thanks to the use of quick-release locking technology.

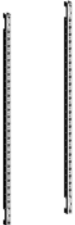



### Selection and ordering data



	Dimensions	DT	Order No.	Price per PU	PU	PS*	PG	Weight per PU approx.	
	mm				Unit(s)	Unit(s)		kg	
	<b>Longitudinal stays</b>								
	For mounting the assembly kits in unequipped distribution boards, two longitudinal stays are required 1 set = 2 stays								
	<b>Height</b>								
	600	A	<b>8GK4 851-4KK00</b>		1 set	1 set	039	1.000	
	750	A	<b>8GK4 851-5KK00</b>		1 set	1 set	039	1.300	
	900	A	<b>8GK4 851-6KK00</b>		1 set	1 set	039	1.500	
	1050	A	<b>8GK4 851-7KK00</b>		1 set	1 set	039	1.800	
	1200	A	<b>8GK4 851-8KK00</b>		1 set	1 set	039	2.080	
	1350	A	<b>8GK4 852-8KK00</b>		1 set	1 set	039	2.340	
	<b>Busbar supports</b>								
	For busbars with a thickness of 5 or 10 mm and a busbar height of 12, 15, 20, 25 or 30 mm, for mounting on longitudinal stays, with fixing screws three-phase		A	<b>8GK9 711-0KK03</b>		1	1	039	1.100
	<b>N/PE busbar supports</b>								
	For flat copper profiles For 5/10 mm busbars		A	<b>5SH3 540</b>		1	1	016	0.059
	<b>Cu busbars</b>								
	<b>Cu cross-section</b>	<b>Length</b>							
	12 × 5 mm, current intensity 250 A	250	A	<b>8GK9 731-0KK10</b>		1	5	039	0.100
		500	A	<b>8GK9 731-0KK20</b>		1	5	039	0.330
		750	A	<b>8GK9 731-0KK30</b>		1	5	039	0.500
		1000	A	<b>8GK9 731-0KK40</b>		1	5	039	0.660
		1250	A	<b>8GK9 731-0KK50</b>		1	5	039	0.830
	20 × 5 mm, current intensity 320 A	250	A	<b>8GK9 733-0KK10</b>		1	5	039	0.290
		500	A	<b>8GK9 733-0KK20</b>		1	5	039	0.570
		750	A	<b>8GK9 733-0KK30</b>		1	5	039	0.850
		1000	A	<b>8GK9 733-0KK40</b>		1	5	039	1.120
		1250	A	<b>8GK9 733-0KK50</b>		1	5	039	1.470
	30 × 5 mm, current intensity 450 A	250	A	<b>8GK9 735-0KK10</b>		1	5	039	0.400
		500	A	<b>8GK9 735-0KK20</b>		1	5	039	0.750
		750	A	<b>8GK9 735-0KK30</b>		1	5	039	1.460
		1000	A	<b>8GK9 735-0KK40</b>		1	5	039	2.170
		1250	A	<b>8GK9 735-0KK50</b>		1	5	039	2.880
	30 × 10 mm, current intensity 630 A	250	A	<b>8GK9 736-0KK10</b>		1	5	039	0.750
		500	A	<b>8GK9 736-0KK20</b>		1	5	039	1.720
		750	A	<b>8GK9 736-0KK30</b>		1	5	039	2.600
1000		A	<b>8GK9 736-0KK40</b>		1	5	039	3.400	
1250		A	<b>8GK9 736-0KK50</b>		1	5	039	4.600	
	<b>Cover profiles for busbars</b>								
	Busbar thickness 5 mm								
	Width 12 mm	1000	A	<b>8US19 22-2CA00</b>		1	10	143	0.200
	Width 15, 20, 25, 30 mm	1000	A	<b>8US19 22-2AA00</b>		1	10	143	0.156
	Busbar thickness 10 mm								
Width 12, 15, 20, 25, 30 mm	1000	A	<b>8US19 22-2BA00</b>		1	10	143	0.105	

\* You can order this quantity or a multiple thereof.

# BETA Protecting SR60 Busbar Systems





## Distribution board components

	Conductor cross-section mm <sup>2</sup>	DT	Order No.	Price per PU	PU Unit(s)	PS* Unit(s)	PG	Weight per PU approx. kg
	<b>Infeed connection module, three-phase</b> For 5/10 mm busbars with cover With screwless terminals, 200 mm long, 20 mm wide							
	1.5 ... 16	A	<b>5SH3 538</b>		1	5	016	0.181
	With screw terminals 200 mm long, 54 mm wide							
	6 ... 50	A	<b>8US19 21-1BA00</b>		1	1	143	0.397
	35 ... 120	A	<b>8US19 21-1AA00</b>		1	1	143	0.607
	(pictured without a cover, but supplied complete with cover) 150 ... 300							
		C	<b>5SH3 535</b>		1	1	016	1.657

Dimensions	Conductor cross-section mm <sup>2</sup>	Tightening torque Nm	DT	Order No.	Price per PU	PU Unit(s)	PS* Unit(s)	PG	Weight per PU approx. kg
<b>Terminals for circular conductors</b>									
 8US19 21-2AA00	Busbar thickness 5 mm								
	1.5 ... 16		▶	<b>8US19 21-2AA00</b>		100	100	143	0.100
	4 ... 35		▶	<b>8US19 21-2AB00</b>		100	50	143	4.600
	16 ... 70		▶	<b>8US19 21-2AD00</b>		1	50	143	0.072
	16 ... 120		▶	<b>8US19 21-2AC00</b>		1	50	143	0.107
	Busbar thickness 10 mm								
	1.5 ... 16		▶	<b>8US19 21-2BA00</b>		1	100	143	0.020
	4 ... 35		▶	<b>8US19 21-2BB00</b>		1	50	143	0.040
	16 ... 70		▶	<b>8US19 21-2BD00</b>		1	50	143	0.070
	16 ... 120		▶	<b>8US19 21-2BC00</b>		1	50	143	0.100
<b>Terminals for one busbar</b>									
	Busbar thickness 5 mm								
	Width 12 mm								
	1.5 ... 6	1.4	A	<b>8JH4 102</b>		1	10	046	0.010
	16 ... 35	3.0	A	<b>8JH4 104</b>		1	10	046	0.030
	16 ... 70	6.0	A	<b>8JH4 105</b>		1	10	046	0.030
	16 ... 95	10.0	A	<b>8JH4 106</b>		1	10	046	0.070
	25 ... 120	10.0	A	<b>8JK3 061</b>		1	10	046	0.090

\* You can order this quantity or a multiple thereof.

## Distribution board components

	Dimensions	Conductor cross-section	Tightening torque	DT	Order No.	Price per PU	PU	PS*	PG	Weight per PU approx.
		mm <sup>2</sup>	Nm				Unit(s)	Unit(s)		kg
	<b>Extension terminals</b>									
	For busbars 12 mm × 5 mm (busbar not included in scope of supply) (1 set = 2 units)		6.0	A	<b>8JK3 201</b>		1 set	10 sets	046	0.100
	<b>Terminals for circular conductors</b>									
	20 mm × 5 mm to 30 mm × 10 mm		150 ... 240	A	<b>8US19 41-2BB00</b>		1	6	143	0.307
	<b>Connection modules</b>									
	For 32 mm cover level with box terminal 6 ... 70 mm <sup>2</sup>			A	<b>3NP1 933-1BC00</b>		1	1	143	0.145
	Dimensions (H × W)			DT	Order No.	Price per PU	PU	PS*	PG	Weight per PU approx.
	mm × mm						Unit(s)	Unit(s)		kg
	<b>Assembly kits</b>									
	Comprising touch protection cover and 4 supports									
	<b>Cutout width</b>									
	For three-phase busbar systems									
	216 mm	300 × 250		A	<b>8GK4 801-2KK13</b>		1	1	039	0.500
	466 mm	300 × 500		A	<b>8GK4 801-2KK23</b>		1	1	039	0.700
	716 mm	300 × 750		A	<b>8GK4 801-2KK33</b>		1	1	039	0.900
	216 mm	450 × 250		A	<b>8GK4 801-3KK13</b>		1	1	039	0.650
	466 mm	450 × 500		A	<b>8GK4 801-3KK23</b>		1	1	039	0.900
	716 mm	450 × 750		A	<b>8GK4 801-3KK33</b>		1	1	039	1.150
	<b>Support for blanking cover</b>									
	For blanking cover mounting on busbar (2 units required for each section of blanking cover)			B	<b>5SH3 536</b>		1	4/160	016	0.040
	<b>Blanking cover</b>									
	Mounting on 5SH3 536 support for blanking covers									
	Length	Height		A	<b>5SH3 537</b>		1	2	016	0.075
	1000 mm	202 mm								

### More information

#### Number of built-in components that can be mounted

Height	Width	Cut-out width	D02/63 A 5SH5 241	D02/63 A 5SH5 242	D02/63 A 5SH5 243	D11/25 A 5SH2 042	D11/63 A 5SH2 242	5SG7 230 bus- mounting switch disconnectors D02
mm	mm	mm	(27 mm wide)	(36 mm wide)	(54 mm wide)	(42 mm wide)	(57 mm wide)	(26.8 mm wide)
300	250	216	8	6	4	5	3	8
	500	466	17	12	8	11	8	17
	750	716	26	19	13	17	12	26
450	250	216	8	6	4	5	3	8
	500	466	17	12	8	11	8	17
	750	715	26	19	13	17	12	26

More information about the SR60 distribution board components of the busbar system can be found in Catalog ET B1 · 2010.

The current issue of the catalog can be downloaded from [www.siemens.com/e-installation-catalogs](http://www.siemens.com/e-installation-catalogs).

\* You can order this quantity or a multiple thereof.

# BETA Protecting SR60 Busbar Systems

## Built-in components

### Overview

Rail-adaptable built-in components, such as NEOZED and DIAZED bus-mounting bases, adapters for modular installation devices, LV HRC fuse switch disconnectors and NEOZED bus-mounting fuse switch disconnectors are made of glass-fiber reinforced, thermoplastic polyester. The material ensures required mechanical, chemical and electrical properties.

Efficient power distribution up to 630 A.

There are many ways for users to mount the SR60 busbar system:

#### 1. Mounting in the distribution board

The busbar supports are mounted on longitudinal stays. Once the built-in components have been mounted and connected, the touch protection cover (front cover) protects against accidental contact with live parts.

#### 2. Mounting in control cabinets

The demand for comprehensive touch protection has generated new solutions: Built-in components, such as bus-mounting fuse bases, have integrated rear reach-through guard, thus enabling the configuration of cost-effective overall solutions.

The two previously available optional solutions can now be replaced with new technology: the touch protection over base and the respective edges, or touch protection by means of partitions.

Overall, increased efficiency and cost savings for the plant manufacturer.

The fuse holders for cylindrical fuses, size 10 × 38 and for American fuses, Class CC, can be used in the international plant engineering industry. In addition, Siemens offers a wide range of UL-approved components for the design of switchgear assemblies in accordance with UL 508 A.

For further information, see chapter BETA devices approved to UL standard in Catalog LV 16 · 2009.



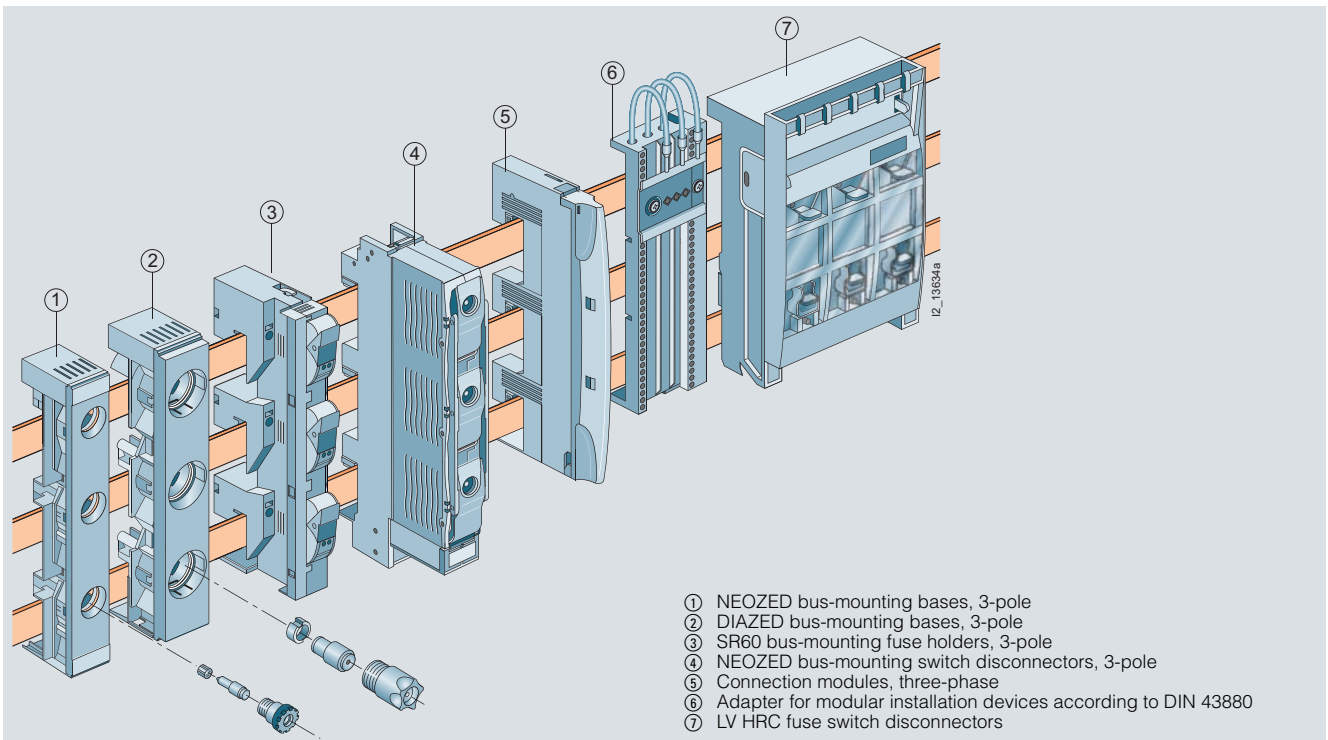



Fuse holders are available with a connection module 16 mm<sup>2</sup> and screwless terminals; this offers users maximum safety and comfort.



### Benefits

- The direct contact of the rail-adaptable switching and installation devices on the Cu busbars reduces distribution panels and mounting times, and
- The transfer resistance of the connections are drastically reduced, when compared to conventional installation. This prevents unnecessary temperature rises.
- New touch-protected built-in components ensure comprehensive touch protection without the previously required partitions
- International implementation due to UL-approved components
- Enhanced effectiveness and increased safety due to screwless terminals.

## Selection and ordering data













	Size	Rated current	Rated voltage	MW	DT	Order No.	Price per PU	PU	PS*	PG	Weight per PU approx.
	A	V						Unit(s)	Unit(s)		kg
	<b>NEOZED SR60 bus-mounting bases with touch protection, 3P</b> For 5/10 mm busbars										
	27 mm wide										
	D02	63	400	1.5	B	<b>5SG6 206</b>		1	4	016	0.175
	36 mm wide										
	D02	63	400	2	B	<b>5SG6 207</b>		1	4	016	0.188
	<b>NEOZED SR60 bus-mounting bases, 3P, standard version</b> For 5/10 mm busbars										
	D02	63	400	1.5	A	<b>5SG6 202</b>		1	4/104	016	0.141
	<b>NEOZED SR60 covers for standard version</b>										
	D02	Extra wide, with clearance for wiring		1.5	A	<b>5SH5 241</b>		1	4/200	016	0.026
	D02			2	B	<b>5SH5 242</b>		1	4/140	016	0.031
	With double width for more clearance for wiring										
	D02			3	C	<b>5SH5 243</b>		1	4/120	016	0.040
	<b>DIAZED SR60 bus-mounting bases with touch protection, 3P</b> For 5/10 mm busbars										
	For use of DIAZED SR60 adapter rings										
	DII	25	500	2.3	B	<b>5SF6 018</b>		1	4	016	0.301
	DIII	63	500 V AC/DC (acc. to DIN VDE 0636-3 also 690 V AC/600 V DC)	3.2	B	<b>5SF6 218</b>		1	4	016	0.402
	For use of DIAZED screw adapters										
	DII	25	500	2.3	B	<b>5SF6 020</b>		1	4	016	0.291
	DIII	63	500 V AC/DC (acc. to DIN VDE 0636-3 also 690 V AC/600 V DC)	3.2	B	<b>5SF6 220</b>		1	4	016	0.392

For NEOZED screw caps, adapter sleeves and fuse links, see Catalog ET B1 · 2010, Chapter, "Low-voltage fuse systems, NEOZED fuse systems".

You can download the up-to-date catalog from [www.siemens.com/e-installation-catalogs](http://www.siemens.com/e-installation-catalogs).

# BETA Protecting SR60 Busbar Systems

## Built-in components



	Size	Rated current	Rated voltage	MW	DT	Order No.	Price per PU	PU	PS*	PG	Weight per PU approx.
	A	V						Unit(s)	Unit(s)		kg
	<b>DIAZED SR60 bus-mounting bases, 3P, standard version</b> For 5/10 mm busbars										
	For use of DIAZED screw adapter rings										
	DII	25	500	2.3	B	<b>5SF6 014</b>		1	2/52	016	0.230
	DIII	63	500 V AC/DC (acc. to DIN VDE 0636-3 also 690 V AC/600 V DC)	3.2	B	<b>5SF6 214</b>		1	2/52	016	0.318
	For use of DIAZED screw adapters										
	DII	25	500	2.3	B	<b>5SF6 015</b>		1	2/52	016	0.222
DIII	63	500 V AC/DC (acc. to DIN VDE 0636-3 also 690 V AC/600 V DC)	3.2	B	<b>5SF6 215</b>		1	2/52	016	0.310	
	<b>DIAZED SR60 covers for standard version</b>										
	DII			2.3	B	<b>5SH2 042</b>		1	2/120	016	0.050
	DIII			3.2	B	<b>5SH2 242</b>		1	2/120	016	0.061
	<b>DIAZED SR60 adapter rings</b> Only for DIAZED SR60 bus-mounting bases										
	DII	2			C	<b>5SH3 071</b>		1	10/1500	016	0.005
		4			C	<b>5SH3 072</b>		1	10/1500	016	0.005
		6			C	<b>5SH3 073</b>		1	10/3000	016	0.005
		10			C	<b>5SH3 074</b>		1	10/4000	016	0.005
		16			C	<b>5SH3 075</b>		1	10/5000	016	0.005
		20			C	<b>5SH3 076</b>		1	10/3000	016	0.004
	DIII	2			C	<b>5SH3 078</b>		1	10	016	0.008
		4			C	<b>5SH3 080</b>		1	10	016	0.008
		6			C	<b>5SH3 081</b>		1	10	016	0.008
		10			C	<b>5SH3 082</b>		1	10	016	0.008
		16			C	<b>5SH3 083</b>		1	10	016	0.008
		20			C	<b>5SH3 084</b>		1	10	016	0.006
		25			C	<b>5SH3 085</b>		1	10/1000	016	0.007
		35			C	<b>5SH3 086</b>		1	10/3500	016	0.006
		50			C	<b>5SH3 087</b>		1	10/600	016	0.005
		<b>SR60 bus-mounting fuse holders, 3P</b> For 5/10 mm busbars with screwless terminals									
For cylindrical fuses 10 x 38 mm  											
--		30	690	1.5	A	<b>3NW7 431</b>		1	1	018	0.185
For UL-listed fuses Class CC  											
--	30	600	1.5	A	<b>3NW7 431-0HG</b>		1	1	018	0.186	
For UL-listed fuses Class CC   with LED signal detector											
--	30	600	1.5	A	<b>3NW7 432-0HG</b>		1	1	018	0.188	
	<b>NEOZED SR60 bus-mounting switch disconnectors, 3P</b> For 5/10 mm busbars										
	D02	63*	400	1.5	A	<b>5SG7 230</b>		1	1/30	016	0.700
	*For loads > 35 A, use 5SH5 526 lateral modules										
	<b>SR60 bus-mounting disconnectors, 3P, for 10 x 38 mm cylindrical fuses</b> For 5/10 mm busbars										
	--	32	690	1.5	A	<b>3NW7 430</b>		1	1/40	018	0.700

For DIAZED screw caps, screw adapters and fuse links, see Catalog ET B1 · 2010, Chapter, "Low-voltage fuse systems, DIAZED fuse systems".

You can download the up-to-date catalog from [www.siemens.com/e-installation-catalogs](http://www.siemens.com/e-installation-catalogs).



\* You can order this quantity or a multiple thereof.

## Built-in components

Size	Rated current A	Rated voltage V	MW	DT	Order No.	Price per PU	PU Unit(s)	PS* Unit(s)	PG	Weight per PU approx. kg	
<b>Auxiliary switches for signaling the switching state of the NEOZED bus-mounting switch disconnectors and disconnectors</b>											
			1 W	0.5	C	<b>5SH5 525</b>		1	1/50	016	0.007
<b>Lateral modules</b> For better heat dissipation from 35 A with NEOZED bus-mounting switch disconnectors											
				0.5	C	<b>5SH5 526</b>		1	5/50	016	0.060
<b>Reducers</b> For NEOZED fuse links D01 In the SR60 bus-mounting switch disconnector											
					C	<b>5SH5 527</b>		1	10/100	016	0.003
<b>SR60 LV HRC bus-mounting fuse bases, 3P, size 00</b> For 5/10 mm busbars With cover, connections at top Terminals up to 70 mm <sup>2</sup> With saddle-type terminals											
			690		A	<b>3NH4 052</b>		1	4	014	0.641

For DIAZED screw caps, screw adapters and fuse links, see [Catalog ET B1 · 2010, Chapter, "Low-voltage fuse systems, DIAZED fuse systems"](#).

You can download the up-to-date catalog from [www.siemens.com/e-installation-catalogs](http://www.siemens.com/e-installation-catalogs).

Number of mounting rails (TH 35)	Rated current A	Conductor cross-section mm <sup>2</sup>	Adapters L x W mm x mm	U <sub>n</sub> V	DT	Order No.	Price per PU	PU Unit(s)	PS* Unit(s)	PG	Weight per PU approx. kg	
<b>Busbar adapters with terminals at top</b>												
	1	25	4	182 x 45	690	A	<b>8US12 50-5RM07</b>		1	1	143	0.174
<b>Busbar adapters with connecting cables at top</b>												
	1	25	4	182 x 45	690	▶	<b>8US12 51-5DM07</b>		1	1	143	0.183
	1	56	10	182 x 55	690	▶	<b>8US12 61-5FM08</b>		1	1	143	0.263
<b>Busbar adapters with Cage Clamp terminals</b>												
	1	12.5	2.5	182 x 45	690	▶	<b>8US12 51-5CM47</b>		1	1	143	0.190
<b>Device holders for lateral mounting on busbar adapters of the same length</b>												
	1	--	--	182 x 45	--	▶	<b>8US12 50-5AM00</b>		1	1	143	0.158
<b>Connecting wedges (2 units needed for mounting)</b>												
	--	--	--	--	--	▶	<b>8US19 98-1AA00</b>		100	100	143	0.100
<b>Lateral modules for extending busbar adapters and device holders of the same length</b>												
	--	--	--	182 x 13.5	--	A	<b>8US19 98-2BM00</b>		1	4	143	0.036

\* You can order this quantity or a multiple thereof.

# BETA Protecting SR60 Busbar Systems

## Mounting components

### Overview

The mounting components enable an enclosed design on a mounting plate.

The base, the holders for the edges, the edges, the supports for blanking covers with blanking cover and the end covers form a complete enclosure with degree of protection IP20.

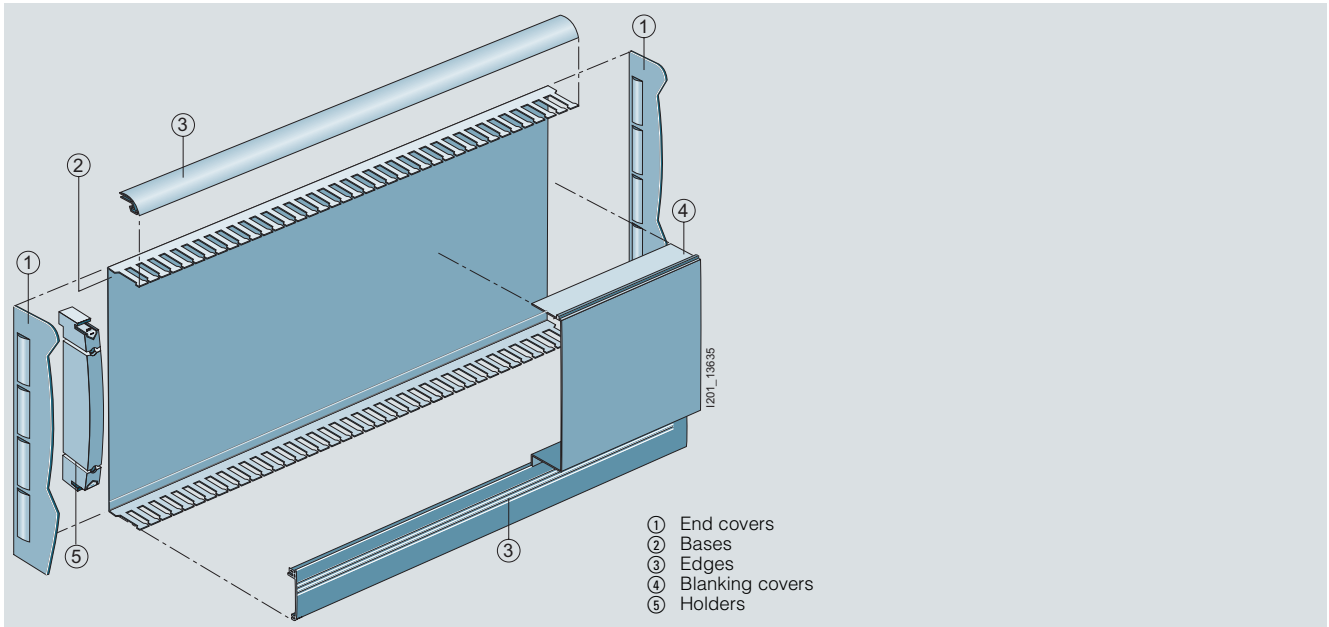









### Benefits

- The mounting components enable a closed design for the SR60 busbar system in any switchgear assembly.
- The touch protection rating to IP20 means that operation is safe, even for non-specialists.



### Selection and ordering data

	Length	DT	Order No.	Price per PU	PU	PS*	PG	Weight per PU approx.
	mm				Unit(s)	Unit(s)		kg
<b>Bases</b>								
	Height							
	230 mm, for 3 busbars 290 mm, for 4 busbars	1100	B C	<b>5SH3 526</b> <b>5SH3 527</b>	1 1	1 2	016 016	1.100 1.300
<b>Blanking covers</b>								
	Mounting on 5SH3 536 support for blanking covers, height 202 mm	1000	A	<b>5SH3 537</b>	1	2	016	0.075
<b>Edges</b>								
	17 × 36 mm, for 3 busbars 77 × 36 mm, for 4 busbars	1100	B C	<b>5SH3 528</b> <b>5SH3 530</b>	1 1	2 2	016 016	0.311 0.583
	<b>Partitions</b>							
	For additional touch protection on systems without bases, slotted 17 × 86 mm	1100	C	<b>5SH3 531</b>	1	2	016	0.365
<b>End covers</b>								
<b>For covering free busbar ends</b>								
	L1-L3, for 8US19 23-2AA01 or 8US19 23-3AA01		A	<b>8US19 22-1AC00</b>	1	10	143	0.020
	L1-L3 + PE/N, 4P, for 8US19 23-4AA00 (1 pack = 2 units, (1× right, 1× left))		A	<b>8US19 22-1AB00</b>	1	1	143	0.055
	For 5SH3 532 holder Height 230 mm (3P)		B	<b>5SH3 533</b>	1	4	016	0.038
	Height 290 mm (4P or 3P + wiring duct), (1 pack = 2 units (1× right, 1× left))		C	<b>5SH3 534</b>	1	4/40	016	0.048
	8US19 22-1AC00 5SH3 534							
<b>Holder</b>								
	For 5SH3 528, 5SH3 530 and 5SH3 531 edges and partitions		B	<b>5SH3 532</b>	1	2	016	0.106
<b>Support for blanking cover</b>								
	For mounting blanking cover on busbar (2 units required for each section of blanking cover)		B	<b>5SH3 536</b>	1	4/160	016	0.040
<b>Busbar supports for SR60 busbar systems</b>								
	For busbars with a thickness of 5 or 10 mm and a busbar height of 12, 15, 20, 25 or 30 mm							
	L1-L3, 3P, with outer mounting		A	<b>8US19 23-2AA01</b>	1	10	143	0.200
	L1-L3, 3P, with inner mounting		A	<b>8US19 23-3AA01</b>	1	10	143	0.200
L1-L3 + PE/N, 4P, with inner mounting		A	<b>8US19 23-4AA00</b>	1	10	143	0.269	

\* You can order this quantity or a multiple thereof.

# BETA Protecting Overvoltage Protection Devices

## Lightning arresters, type 1

### Overview

Type 1 lightning arresters protect low-voltage systems against overvoltages and high surge currents that can be triggered by direct or indirect lightning strikes.

The protection level is lowered to 1.5 kV by the lightning arrester.

The lightning arresters are enclosed and suitable for mounting in the precounter sector.



All spark gaps are triggered. For this reason, decoupling reactors are no longer required for the installation of overvoltage protection devices.

The lightning arresters are tested using wave-shaped lightning impulses, 25 ... 100 kA with waveform 10/350 µs.

### Benefits

- The rated arrester voltage is a uniform 350 V AC. This increases safety in systems with extended voltage overshoots.
- All lightning arresters are fitted with a mechanical fault indication that does not require an extra power supply. This means they can be installed in the precounter sector, where electrical plants can be protected particularly effectively.
- The protective modules are plug-in versions. No dismantling of electrical wires required when replacing the protective modules. When taking insulation measurements, the protective modules are simply removed in order to disconnect from the power supply.
- All lightning arresters have a remote signaling contact, which signals if the device fails.

### Selection and ordering data

Version	Discharge capacity kA	MW	DT	Order No.	Price per PU	PU Unit(s)	PS* Unit(s)	PG	Weight per PU approx. kg
 <b>Lightning arresters</b> 1P For single-conductor systems with remote signaling	25	2	A	<b>5SD7 411-1</b>		1	1	008	0.424
 2P For TN-S and TT systems with remote signaling	100	4	B	<b>5SD7 412-1</b>		1	1	008	0.732
 3P For TN-C systems with remote signaling	75	6	A	<b>5SD7 413-1</b>		1	1	008	0.909
 4P For TN-S and TT systems with remote signaling	100	8	A	<b>5SD7 414-1</b>		1	1	008	1.310

\* You can order this quantity or a multiple thereof.

# BETA Protecting Overvoltage Protection Devices

## Combination surge arresters, type 1 and type 2

### Overview

Type 1 and type 2 combination surge arresters protect low-voltage systems against the overvoltages and high currents that can be triggered by direct lightning strikes. They are tested by wave-shaped lightning impulses, 25 ... 100 kA with waveform 10/350  $\mu$ s.

The protection level is lowered to 1.5 kV by the combination surge arresters.





A thermal isolating arrester disconnecter offers a high degree of protection against overload.

All spark gaps are triggered. For this reason, decoupling reactors are no longer required for the installation of overvoltage protection devices.

### Benefits

- The rated arrester voltage is a uniform 350 V AC. This increases safety in systems with extended voltage overshoots.
- All combination surge arresters are fitted with a mechanical fault indication that does not require an extra power supply.
- The protective modules are plug-in versions. No dismantling of electrical wires required when replacing the protective modules. When taking insulation measurements, the protective modules are simply removed, in order to ensure disconnection from the power supply.
- The same type 2 overvoltage protective modules are used as for the slim version of the surge arresters (5SD7 42.). This simplifies stock keeping.
- All combination surge arresters have a remote signaling contact, which signals if the device fails.

### Selection and ordering data

Version	Discharge capacity kA	MW	DT	Order No.	Price per PU	PU Unit(s)	PS* Unit(s)	PG	Weight per PU approx. kg
<b>Combination surge arresters</b>									
 1P For single-conductor systems with remote signaling	25	2	A	<b>5SD7 441-1</b>		1	1	008	0.356
 2P For TN-S and TT systems with remote signaling	100	4	B	<b>5SD7 442-1</b>		1	1	008	0.770
 3P For TN-C systems with remote signaling	75	6	A	<b>5SD7 443-1</b>		1	1	008	1.040
 4P For TN-S and TT systems with remote signaling	100	8	A	<b>5SD7 444-1</b>		1	1	008	1.430

\* You can order this quantity or a multiple thereof.

# BETA Protecting Overvoltage Protection Devices

## Surge arresters, type 2

### Overview

Surge arresters type 2 are used after lightning arresters type 1 in main distribution boards or sub-distribution boards. They protect low-voltage systems against transient overvoltages.

The type 2 surge arrester lowers the protection level to 1.4 to 1.5 kV. A remote signaling contact indicates whether a protective module has been disconnected from the network by the thermal arrester disconnecter or whether it is just not plugged in.

All spark gaps are triggered. For this reason, decoupling reactors are no longer required for the installation of overvoltage protection devices.

To ensure fault-free operation of photovoltaic systems, it is essential to have standardized protection against lightning and overvoltages. SPDs (5SD7 483-.) for the DC side protect the photovoltaic generator and the inverter against overvoltages.

The SPDs 5SD7 473- . and 5SD7 485- . are available specially for the protection of IT systems.





### Benefits

- The rated arrester voltage is a uniform 350 V AC. This increases safety in systems with extended voltage overshoots.
- All type 2 surge arresters are fitted with a mechanical fault indication that does not require an extra power supply
- A thermal isolating arrester installed in each device offers a high degree of protection. In the event of overload, the surge arrester is disconnected from the mains - the plant continues running.
- The protective modules are plug-in versions. No dismantling of electrical wires required when replacing the protective modules. When taking insulation measurements, the protective modules are simply removed in order to disconnect from the power supply.
- All surge arresters are available with a remote signaling contact, which signals if the device fails.

# BETA Protecting Overvoltage Protection Devices

## Surge arresters, type 2



### Selection and ordering data



Version	Max. continuous voltage $U_C$	Dis-charge surge current $I_n/I_{max}$	MW	DT	Order No.	Price per PU	PU	PS*	PG	Weight per PU approx.
	V	kA					Unit(s)	Unit(s)		kg
<b>Surge arresters, standard design</b>										
• 1P, plug-in										
	- Without remote signaling	350 AC	20/40	1	A	<b>5SD7 461-0</b>	1	1	008	0.130
	- With remote signaling	350 AC	20/40	1	A	<b>5SD7 461-1</b>	1	1	008	0.134
• N/PE, 1P, plug-in										
	- Without remote signaling	260 AC	20/40	1	A	<b>5SD7 481-0</b>	1	1	008	0.131
	- With remote signaling									
• 3P, plug-in, 3+0 circuit for TN-C systems										
	- Without remote signaling	350 AC	20/40	3	A	<b>5SD7 463-0</b>	1	1	008	0.393
	- With remote signaling	350 AC	20/40	3	B	<b>5SD7 463-1</b>	1	1	008	0.403
• 3P, plug-in, 3+0 circuit for IT systems										
	- Without remote signaling	580 AC	15/30	3	A	<b>5SD7 473-0</b>	1	1	008	0.384
	- With remote signaling	580 AC	15/30	3	A	<b>5SD7 473-1</b>	1	1	008	0.371
• 3P, plug-in in order to protect the DC part of the photovoltaic systems up to DC 1000 V acc. to IEC 60364-7-712										
	- Without remote signaling	1000 DC	15/30	3	A	<b>5SD7 483-0</b>	1	1	008	0.344
	- With remote signaling	1000 DC	15/30	3	A	<b>5SD7 483-1</b>	1	1/44	008	0.352

\* You can order this quantity or a multiple thereof.

# BETA Protecting Overvoltage Protection Devices

## Surge arresters, type 2

Version	Max. continuous voltage $U_C$	Discharge surge current $I_n/I_{max}$	MW	DT	Order No.	Price per PU	PU	PS*	PG	Weight per PU approx.
	V	kA					Unit(s)	Unit(s)		kg
 <ul style="list-style-type: none"> <li>• 4P, plug-in, 3+1 circuit for TN-S and TT systems</li> <li>- Without remote signaling</li> <li>- With remote signaling</li> </ul>	350 AC	20/40	4	A	<b>5SD7 464-0</b>		1	1	008	0.433
	350 AC	20/40	4	A	<b>5SD7 464-1</b>		1	1	008	0.443
 <ul style="list-style-type: none"> <li>• 4P, plug-in, 4+0 circuit for IT systems with N conductor incorporated in the cable</li> <li>- Without remote signaling</li> <li>- With remote signaling</li> </ul>	440 AC	20/40	4	A	<b>5SD7 485-0</b>		1	1/44	008	0.445
	440 AC	20/40	4	A	<b>5SD7 485-1</b>		1	1	008	0.455

Version	Discharge surge current $I_n/I_{max}$	Width	DT	Order No.	Price per PU	PU	PS*	PG	Weight per PU approx.	
	kA	mm (MW)				Unit(s)	Unit(s)		kg	
<b>Surge arresters, narrow design</b>										
 <ul style="list-style-type: none"> <li>• 2P</li> <li>For TN-S and TT systems</li> <li>- Without remote signaling</li> <li>- With remote signaling</li> </ul>	20/40	24 (1 1/3)	A	<b>5SD7 422-0</b>		1	1	008	0.220	
	20/40	24 (1 1/3)	B	<b>5SD7 422-1</b>		1	1	008	0.227	
 <ul style="list-style-type: none"> <li>• 3P</li> <li>For TN-C systems</li> <li>- Without remote signaling</li> <li>- With remote signaling</li> </ul>	20/40	36 (2)	A	<b>5SD7 423-0</b>		1	1	008	0.320	
	20/40	36 (2)	B	<b>5SD7 423-1</b>		1	1	008	0.330	
 <ul style="list-style-type: none"> <li>• 4P</li> <li>For TN-S and TT systems</li> <li>- Without remote signaling</li> <li>- With remote signaling</li> </ul>	20/40	48 (2 2/3)	A	<b>5SD7 424-0</b>		1	1	008	0.408	
	20/40	48 (2 2/3)	A	<b>5SD7 424-1</b>		1	1	008	0.416	

\* You can order this quantity or a multiple thereof.

# BETA Protecting Overvoltage Protection Devices

## Surge arresters, type 3

### Overview

Type 3 surge arresters are installed downstream of type 2 surge arresters in sub-distribution boards close to the loads in single or multiphase systems and further limit the overvoltage in order to protect the connected loads.

In the voltage variants 24, 60, 120 and 240 V it is possible to use the surge arresters type 3 in AC and DC networks.

### Benefits

- The protective modules are plug-in versions. No mounting work required when replacing the protective modules
- All type 3 surge arresters are fitted with a mechanical fault indication that does not require an extra power supply
- Remote signaling is performed by an optocoupler with an open collector output in case of failure.

### Selection and ordering data

Version	Rated voltage $U_N$	MW	DT	Order No.	Price per PU	PU	PS*	PG	Weight per PU approx.
	V AC/V DC					Unit(s)	Unit(s)		kg
<b>Surge arresters, plug-in</b>									
• 2P									
With remote signaling	24	1	A	<b>5SD7 432-4</b>		1	1	008	0.027
	60	1	B	<b>5SD7 432-3</b>		1	1	008	0.026
	120	1	B	<b>5SD7 432-2</b>		1	1	008	0.081
	230	1	A	<b>5SD7 432-1</b>		1	1	008	0.071
• 4P									
With remote signaling	230/400	2	A	<b>5SD7 434-1</b>		1	1	008	0.056











\* You can order this quantity or a multiple thereof.

# BETA Protecting Overvoltage Protection Devices

## Accessories for surge arresters

### Selection and ordering data

	Version	DT	Order No.	Price per PU	PU Unit(s)	PS* Unit(s)	PG	Weight per PU approx. kg
	<b>Male connectors for lightning arresters, type 1, and combination surge arresters, type 1 and type 2</b> <ul style="list-style-type: none"> <li>Lightning arresters L/N <math>I_{fi}</math> 50 kA<sub>rms</sub> for 5SD7 41. lightning arresters</li> <li>Lightning arresters N/PE for 5SD7 41. lightning arresters and 5SD7 44. combination surge arresters.</li> </ul>	B	<b>5SD7 418-1</b>		1	1	008	0.240
		B	<b>5SD7 418-0</b>		1	1	008	0.240
	<b>Male connectors for lightning arresters, type 1, and combination surge arresters, type 1 and type 2</b> <ul style="list-style-type: none"> <li>Lightning arresters L/N <math>I_{fi}</math> 50 kA<sub>rms</sub></li> <li>Lightning arresters N/PE for 5SD7 41. lightning arresters and 5SD7 44. combination surge arresters.</li> </ul>	B	<b>5SD7 448-1</b>		1	1	008	0.129
		B	<b>5SD7 418-0</b>		1	1	008	0.240
	<b>Male connectors for surge arresters, type 2, and combination surge arresters, type 1 and type 2</b> <ul style="list-style-type: none"> <li>Surge arresters L/N for 5SD7 42. surge arresters and 5SD7 44. combination surge arresters.</li> <li>Lightning arresters N/PE for 5SD7 41. lightning arresters and 5SD7 44. combination surge arresters.</li> </ul>	B	<b>5SD7 428-1</b>		1	1	008	0.052
		B	<b>5SD7 428-0</b>		1	1	008	0.049
	<b>Male connector for 5SD7 46. combination surge arresters, type 2</b> <ul style="list-style-type: none"> <li>Surge arresters L/N</li> <li>Surge arresters N/PE</li> </ul>	B	<b>5SD7 468-1</b>		1	1	008	0.051
		B	<b>5SD7 488-0</b>		1	1	008	0.040
	<b>Male connector for 5SD7 485. combination surge arresters, type 2</b> <ul style="list-style-type: none"> <li>Surge arresters for IT systems</li> </ul>	A	<b>5SD7 488-1</b>		1	1	008	0.053
	<b>Male connector for 5SD7 473-., 5SD7 483-. combination surge arresters, type 2</b> <ul style="list-style-type: none"> <li>Surge arresters for photovoltaic systems and IT systems</li> </ul>	A	<b>5SD7 498-1</b>		1	1	008	0.065
	<b>Male connector for 5SD7 432-. combination surge arresters, type 3</b> <ul style="list-style-type: none"> <li>Rated voltage <math>U_N = 230</math> V</li> <li>Rated voltage <math>U_N = 120</math> V</li> <li>Rated voltage <math>U_N = 60</math> V</li> <li>Rated voltage <math>U_N = 24</math> V</li> </ul>	B	<b>5SD7 437-1</b>		1	1	008	0.028
		B	<b>5SD7 437-2</b>		1	1	008	0.027
		B	<b>5SD7 437-3</b>		1	1	008	0.026
		B	<b>5SD7 437-4</b>		1	1	008	0.027
	<b>Male connector for 5SD7 434-1 combination surge arresters, type 3</b>	B	<b>5SD7 438-1</b>		1	1	008	0.162

\* You can order this quantity or a multiple thereof.



# BETA Protecting Overvoltage Protection Devices

Surge arresters for  
measuring and control technology

## Overview

The new surge arresters for measuring and control technology are overvoltage protection modules, which comprise one basic element and one male connector, i. e. two components. Their application area is the protection of signal circuits.

The cable shields of basic elements can be either directly or indirectly grounded.

The mounting width of the new surge arresters is 1 MW.

Through the number of integrated paths, it is possible to protect up to four signal cores or two twin-wires against overvoltages.



## Benefits

- The two-component design offers users maximum maintenance convenience. The basic element is always a fixed integral part of the installation. No laborious interventions, e. g. in the case of repair work
- The benefits:
  - Two-component design, comprising one male connector and one basic element
  - Interruption-free and impedance neutral plugging in and pulling out of the male connector
  - Reverse polarity protection through mechanical encoding
  - Surge current carrying capable contacting to standard mounting rail thanks to snap-on technique – no further laborious wiring of the reference potential.
- The arrangement of suppressor diodes between signal cores achieves a fine protection in connection with a fast response. The low capacitive coupling of the suppressor diodes to the signal cores enables high data transmission rates
- The use of gas-filled surge arresters ensures a high discharge capacity.

# BETA Protecting Overvoltage Protection Devices

Surge arresters for  
measuring and control technology

## Selection and ordering data

Version	MW	DT	Order No.	Price per PU	PU Unit(s)	PS* Unit(s)	PG	Weight per PU approx. kg	
	<b>Basic element</b>								
		1	B	<b>5SD7 512-1</b>		1	1	008	0.052
	<ul style="list-style-type: none"> <li>For male connectors with protection circuit for a 2-wire ungrounded signal circuit</li> <li>Jumper between terminals 3/4 (GND) and 9/10</li> <li>For 5SD7 520-1 and 5SD7 530-3 male connectors</li> </ul>								
		1	B	<b>5SD7 522-1</b>		1	1	008	0.056
	<ul style="list-style-type: none"> <li>For male connectors with protection circuit for a 2-wire ungrounded signal circuit</li> <li>Jumper between terminals 3/4 (GND) and 9/10</li> <li>For 5SD7 522-1 and 5SD7 550-4 male connectors</li> </ul>								
		1	B	<b>5SD7 522-0</b>		1	1	008	0.057
	<ul style="list-style-type: none"> <li>For male connectors with protection circuit for a 2-wire ungrounded signal circuit</li> <li>Gas arrester between terminals 3/4 (GND) and 9/10</li> <li>For 5SD7 522-1 and 5SD7 550-4 male connectors</li> </ul>								
		1	B	<b>5SD7 541-1</b>		1	1	008	0.056
	<ul style="list-style-type: none"> <li>For male connectors with protection circuit for four conductors single-sided grounded signal circuit</li> <li>Jumper between terminals 3/4 (GND) and 9/10</li> <li>For 5SD7 541-7 male connectors</li> </ul>								
		1	B	<b>5SD7 500-0</b>		1	1	008	0.050
<ul style="list-style-type: none"> <li>Jumper between terminals 3/4 (GND) and 9/10</li> <li>For 5SD7 502-0 male connectors</li> </ul>									
	<b>Male connector - PROFIBUS</b>								
		1	B	<b>5SD7 530-3</b>		1	1	008	0.020
	<ul style="list-style-type: none"> <li>Protection for 2 signal cores with shared reference potential</li> <li>For 5SD7 512-1 basic element</li> </ul>								
	<b>Male connector for analog telecommunication interfaces</b>								
		1	B	<b>5SD7 520-1</b>		1	1	008	0.020
	<ul style="list-style-type: none"> <li>Protection for 2-wire Telecom cable (<math>U_{k0}</math> or T-DSL)</li> <li>For 5SD7 512-1 basic element</li> </ul>								
	<b>Male connector, 24 V AC</b>								
		1	B	<b>5SD7 522-7</b>		1	1	008	0.024
<ul style="list-style-type: none"> <li>Protection for 2-wire ungrounded signal circuit.</li> <li>Fine protection element between the respective wires</li> <li>For 5SD7 522-0 and 5SD7 522-1 basic elements</li> </ul>									
<b>Male connector, 12 V DC</b>									
	1	B	<b>5SD7 550-4</b>		1	1	008	0.026	
<ul style="list-style-type: none"> <li>Protection for fieldbus systems and signal circuits in 3 or 4-wire method</li> <li>For 5SD7 522-0 and 5SD7 522-1 basic elements</li> </ul>									
<b>Male connector, 24 V DC</b>									
	1	B	<b>5SD7 541-7</b>		1	1	008	0.026	
<ul style="list-style-type: none"> <li>Protection for 4 signal cores with shared reference potential</li> <li>For 5SD7 541-1 basic element</li> </ul>									
<b>Male connector, 2-wire</b>									
	1	B	<b>5SD7 502-0</b>		1	1	008	0.020	
<ul style="list-style-type: none"> <li>Coarse protection for 2 single-sided signal leads</li> <li>For 5SD7 500-0 basic element</li> </ul>									

\* You can order this quantity or a multiple thereof.

## Overview

The socket outlets for mounting in distribution boards to DIN 43880 and on standard mounting rails to DIN 60715 have since become standard in modern switchgear assemblies/distribution boards. They are used for tasks such as the connection of plug-in communication devices in communication distribution boards, in switchgear assemblies for maintenance purposes or in private plants for the occasional use of devices with heavy starting and separate fusing.

The socket outlet range complies with a number of different standards and is available according to the standards of the following countries: VDE for Germany, CEE7 for Belgium/France, CEI for Italy and UL for USA.





In distribution boards with 55 mm mounting depth the socket outlet can only be used without the hinged lid. The lids can be retrofitted on all devices. To make installation easier, the touch-protected terminals L, N and PE are located on the side of the socket outlet.

In system components where equipment is still live, even after the main control switch has been disconnected, this must be indicated according to DIN VDE 0105-1 and IEC/EN 60204-1/ DIN VDE 0113-1. Yellow socket outlets are used for these applications.

## Benefits

- Complete program according to VDE, UL, CEI and CEE for worldwide application.
- By pulling on the hinges, the hinged lid stays open at more than 180°. This facilitates manual insertion of plugs.

## Selection and ordering data



	$U_e$	$I_e$	Conductor cross-section	MW	DT	Order No.	Price per PU	PU	PS*	PG	Weight per PU approx.
	V AC	A	mm <sup>2</sup>					Unit(s)	Unit(s)		kg
	<b>SCHUKO</b> -socket outlets acc. to DIN VDE 0620-1										
	• Without hinged lid										
	230	16	6	2.5	▶	<b>5TE6 800</b>		1	1	027	0.089
	<b>SCHUKO</b> -socket outlets acc. to DIN VDE 0620-1										
	• With hinged lid										
	230	16	6	2.5	▶	<b>5TE6 801</b>		1	1	027	0.094
	<b>SCHUKO</b> -socket outlets acc. to DIN VDE 0620-1										
	• Without hinged lid, yellow RAL 1018										
	230	16	6	2.5	▶	<b>5TE6 810</b>		1	1	027	0.089
	<b>Socket outlets acc. to CEI 23-50</b>										
	• With hinged lid										
	230	16	6	2.5	▶	<b>5TE6 802</b>		1	1	027	0.094

\* You can order this quantity or a multiple thereof.

# BETA Switching

## Socket Outlets

### 5TE6 8 socket outlets

	$U_e$	$I_e$	Conductor cross-section	MW	DT	Order No.	Price per PU	PU	PS*	PG	Weight per PU approx.
	V AC	A	mm <sup>2</sup>					Unit(s)	Unit(s)		kg
 <p><b>Socket outlets according to CEE 7, Standard sheet V</b></p> <ul style="list-style-type: none"> <li>Without hinged lid, with grounding pin</li> </ul>	230	16	6	2.5	▶	<b>5TE6 803</b>		1	1	027	0.090
	<p><b>Socket outlets according to UL 498</b></p> <ul style="list-style-type: none"> <li>Without hinged lid</li> </ul>										
	125	15	6	2.5	▶	<b>5TE6 804</b>		1	1	027	0.088
	<p><b>Hinged lids for 5TE6 socket outlets</b></p>										
				2.5	B	<b>5TE9 120</b>		1	1	027	0.020

#### More information

More information about socket outlets can be found in Catalog ET B1 · 2010.  
The current issue of the catalog can be downloaded from [www.siemens.com/e-installation-catalogs](http://www.siemens.com/e-installation-catalogs)

\* You can order this quantity or a multiple thereof.

# BETA Measuring Three-Phase Measuring Devices

7KT1 30 multimeters

## Overview

Multimeters are mainly used in power distribution boards for in-feeds into buildings and plants. They replace the more common analog voltmeters and ammeters with measuring point changeover, as well as measuring devices for power outputs and power factor p.f.



The standard measured quantity to be indicated in the 5 display fields of the multimeter can be tailored to customer requirements. Versions for direct connection 63 A or for transformers /5 A with adjustable transformer primary current from 5 to 5000 A support a wide range of applications.

The green 7-segment displays for the measured values and the orange indicators of the units of measurement directly alongside the measured values make for easy reading.

## Benefits

- Clear display of all necessary measured values
- All measured values can be read from a distance
- Customized setting of the measured quantities for the standard display
- Wide range of application thanks to flexible adaptation to measuring current transformers
- Detection of connection errors during start-up saves considerable time when trying to locate faults
- Large, 11 mm high, green 7-segment displays for measured values makes for easy reading
- Indication of units of measurement directly alongside the related measured values provide a clear overview.

## Selection and ordering data

	$U_e$	$I_e$	$U_c$	MW	DT	Order No.	Price per PU	PU	PS*	PG	Weight per PU approx.
	V AC	A AC	V AC					Unit(s)	Unit(s)		kg
<b>Multimeters</b>											
<b>For the display of 23 electrical values, of which 5 values can be continuously displayed.</b>											
<b>Standard rail mounting</b>											
	For direct connection					<b>7KT1 300</b>		1	1	027	0.400
	3 × 230/400	63	230	6	B						
	For transformer connection 5 ... 5000 A, adjustable in 5 A increments, secondary current 5 A					<b>7KT1 301</b>		1	1	027	0.380
	3 × 230/400	Trans-former /5	230	6	B						
<b>Front mounting</b>											
	For transformer connection 5 ... 5000 A, adjustable in 5 A increments, secondary current 5 A, mounting dimensions 96 mm × 96 mm					<b>7KT1 302</b>		1	1	027	0.378
	3 × 230/400	Trans-former /5	230	--	B						

\* You can order this quantity or a multiple thereof.

# BETA Measuring Three-Phase Measuring Devices

## 7KT1 30 multimeters

### More information

#### Voltage measurement

The multimeter measures the delta voltages L1 against L2; L2 against L3 and L3 against L1 or the star voltages L1, L2, L3 against N.

#### $\Sigma L$ symbol for the three-phase system

This indicates that all physical units shown under this symbol are always 3 phase.

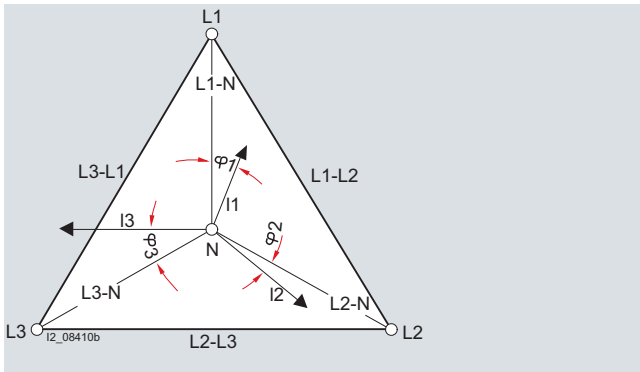

#### Readout data

You can continuously display 5 measured quantities from the following 23 options.

No.	Measured value	Display	Unit	Assignment
1	Active power	D1	W	L1
2	Voltage	D1	V	L1
3	Current	D1	A	L1
4	Apparent power	D1	VA	L1
5	P.f.	D1	P.f.	L1
6	Voltage	D1	V	L1 – L2
7	Active power	D2	W	L2
8	Voltage	D2	V	L2
9	Current	D2	A	L2
10	Apparent power	D2	VA	L2
11	P.f.	D2	P.f.	L2
12	Voltage	D2	V	L2 – L3
13	Active power	D3	W	L3
14	Voltage	D3	V	L3
15	Current	D3	A	L3
16	Apparent power	D3	VA	L3
17	P.f.	D3	P.f.	L3
18	Voltage	D3	V	L3 – L1
19	Active power	D1, D2, D3, D5	W	$\Sigma L$
20	Apparent power	D1, D2, D3, D5	VA	$\Sigma L$
21	reactive power	D5	var	$\Sigma L$
22	Frequency	D4	Hz	$\Sigma L$
23	P.f.	D1, D2, D3, D4	P.f.	$\Sigma L$

2 set values are also indicated:

24	Transformer setting	D5	CT/A	/5
25	Transformer setting		CT/A	5 ... 5000

#### Matrix selection

Conventional measuring instruments display voltages, currents, powers, etc. in a rigid sequence on several "screens". These multimeters allow users to define their own standard for measured quantities per display field, so that they can be implemented far more universally and flexibly.

A special feature is the analysis of the different loads on the phases. Phase displacement and unsymmetrical or unbalanced loads can cause partial overloads. These multimeters offer a range of different options for combining and assessing measured values.

The display fields are selected using rotary switches and the desired indications confirmed with OK. By making the horizontal selection e. g. W, V, A or p.f., and the vertical selection, e. g. L1, L1 – L2 or  $\Sigma L$ , users can then define the desired measured quantities for this display field.

The vertical data on the display can be assigned to any measured value in the horizontal data. The letters M(ega) and k(ilo) are automatically assigned according to measuring range, i. e. measured value, e. g. kW or MW. Capacitive loads are automatically indicated by a capacitor, inductive loads by a coil.

The following diagram shows an example of what your matrix selection might look like.

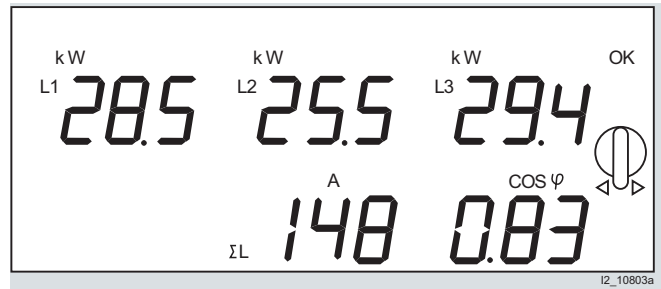

More information about multimeters can be found in Catalog ET B1 · 2010.

The current issue of the catalog can be downloaded from [www.siemens.com/e-installation-catalogs](http://www.siemens.com/e-installation-catalogs).

# BETA Measuring Three-Phase Measuring Devices

## 7KT1 31, 7KT1 34, 7KT1 35 multicontractors

### Overview

Multicontractors are mainly used in power distribution boards for in-feeds into buildings and plants. They replace the more common analog voltmeters and ammeters with measuring point changeover, as well as measuring devices for power outputs and power factor p.f.

The standard measured quantity to be indicated in the 6 display fields of the multicontractor can be tailored to customer requirements. The measured values of all measured quantities can also be displayed quickly and easily over the operator buttons. Versions for direct connection 63 A or for transformers /5 A with adjustable transformer primary current from 5 to 5000 A support a wide range of applications.

The green 7-segment displays for the measured values and the orange indicators of the units of measurement directly alongside the measured values make for easy reading.

### Benefits

- Clear display of all necessary measured values
- All measured values can be read from a distance
- Customized setting of the measured quantities for the standard display Fast display of all measured quantities over operator buttons
- Wide range of application thanks to flexible adaptation to measuring current transformers
- Detection of incorrect connections during installation
- Communication with LAN, Modbus or PROFIBUS DP enables integration in an energy management system
- Software package for data transmission over LAN and visualization of measured data with Microsoft EXCEL enables implementation of customized solutions.

### Selection and ordering data

$U_e$	$I_e$	$U_c$	MW	DT	Order No.	Price per PU	PU	PS*	PG	Weight per PU approx.
V AC	A AC	V AC					Unit(s)	Unit(s)		kg
<b>Multicontractors</b>										
For the display of 35 electrical values, of which 5 or 6 values can be continuously displayed. For three-phase, 3/4 conductor connection, with S0 interface										
<b>Without communication interface</b>										
<b>Standard rail mounting</b>										
For direct connection										
	3 × 230/400	63	230	6	B	<b>7KT1 310</b>	1	1	027	0.420
For transformer connection 5 ... 5000 A, adjustable in 5 A increments, secondary current 5 A										
	3 × 230/400	Trans-former /5	230	6	B	<b>7KT1 311</b>	1	1	027	0.410
<b>Front mounting</b>										
For transformer connection 5 ... 5000 A, adjustable in 5 A increments, secondary current 5 A, mounting dimensions 96 mm × 96 mm										
	3 × 230/400	Trans-former /5	230	--	B	<b>7KT1 312</b>	1	1	027	0.410
<b>With RS485 interface and RTU Modbus protocol or for connection to LAN networks over 7KT1 390 LAN coupler</b>										
<b>Standard rail mounting</b>										
For direct connection										
	3 × 230/400	63	230	6	B	<b>7KT1 340</b>	1	1	027	0.470
For transformer connection 5 ... 5000 A, adjustable in 5 A increments, secondary current 5 A										
	3 × 230/400	Trans-former /5	230	6	B	<b>7KT1 341</b>	1	1	027	0.423
<b>Front mounting</b>										
For transformer connection 5 ... 5000 A, adjustable in 5 A increments, secondary current 5 A, mounting dimensions 96 mm × 96 mm										
	3 × 230/400	Trans-former /5	230	--	B	<b>7KT1 342</b>	1	1	027	0.397



7KT1 310



7KT1 312

\* You can order this quantity or a multiple thereof.

# BETA Measuring Three-Phase Measuring Devices

## 7KT1 31, 7KT1 34, 7KT1 35 multimeters

$U_e$	$I_e$	$U_c$	MW	DT	Order No.	Price per PU	PU	PS*	PG	Weight per PU approx.
V AC	A AC	V AC					Unit(s)	Unit(s)		kg
<b>With PROFIBUS DP V0 interface</b>										
<b>Standard rail mounting</b>										
For direct connection										
3 × 230/400	63	230	6	B	<b>7KT1 350</b>		1	1	027	0.415
For transformer connection 5 ... 5000 A, adjustable in 5 A increments, secondary current 5 A										
3 × 230/400	Trans- former /5	230	6	B	<b>7KT1 351</b>		1	1	027	0.415
<b>Front mounting</b>										
For transformer connection 5 ... 5000 A, adjustable in 5 A increments, secondary current 5 A, mounting dimensions 96 mm × 96 mm										
3 × 230/400	Trans- former /5	230	--	B	<b>7KT1 352</b>		1	1	027	0.460

### More information

#### Voltage measurement

Depending on the selected connection type, the multimeter measures the delta voltages L1 against L2; L2 against L3 and L3 against L1 or the star voltages L1, L2, L3 against N.

#### ∑L symbol for the three-phase system

This indicates that all physical units shown under this symbol are always 3 phase.

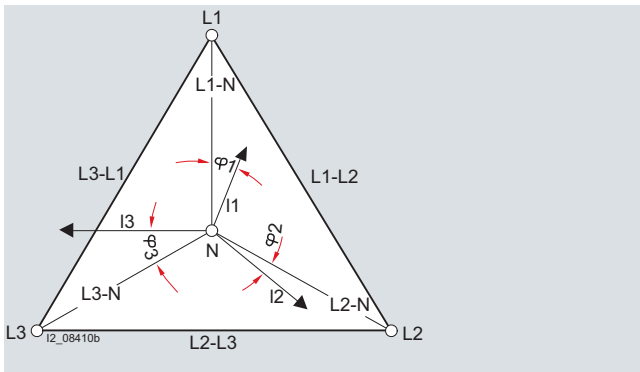

More information about multimeters can be found in Catalog ET B1 · 2010.

The current issue of the catalog can be downloaded from [www.siemens.com/e-installation-catalogs](http://www.siemens.com/e-installation-catalogs).

#### Readout data

You can continuously display 6 measured quantities from the following 35 options:

No.	Measured value	Display	Unit	Assignment
1	Active power	D1	W	L1
2	Voltage	D1	V	L1
3	Current	D1	A	L1
4	Apparent power	D1	VA	L1
5	P.f.	D1	P.f.	L1
6	Voltage	D1	V	L1 – L2
7	Active power	D2	W	L2
8	Voltage	D2	V	L2
9	Current	D2	A	L2
10	Apparent power	D2	VA	L2
11	P.f.	D2	P.f.	L2
12	Voltage	D2	V	L2 – L3
13	Active power	D3	W	L3
14	Voltage	D3	V	L3
15	Current	D3	A	L3
16	Apparent power	D3	VA	L3
17	P.f.	D3	P.f.	L3
18	Voltage	D3	V	L3 – L1
19	Temperatures	D6	°C	–
20	Current, N conductor	D6	A	∑L
21	Active power	D4	W	∑L
22	reactive power	D5	var	∑L
23	Apparent power	D5	var	∑L
24	Frequency	D6	Hz	∑L
25	P.f.	D1, D2, D3, D6	P.f.	∑L
26	Active energy tariff 1	D4	Wh	∑L →
27	Active energy tariff 2	D4	Wh	∑L →
28	Active energy tariff 1	D4	Wh	∑L ←
29	Active energy tariff 2	D4	Wh	∑L ←
30	Reactive energy tariff 1	D5	varh	∑L, ind.
31	Reactive energy tariff 2	D5	varh	∑L, ind.
32	Reactive energy tariff 1	D5	varh	∑L, cap.
33	Reactive energy tariff 2	D5	varh	∑L, cap.
34	Apparent energy tariff 1	D5	VAh	∑L
35	Apparent energy tariff 2	D5	VAh	∑L
2 set values are also indicated:				
36	Transformer setting	D4	CT/A	/5
37	Transformer setting	D5	CT/A	5 ... 5000

All the measured values are transmitted via LAN.

\* You can order this quantity or a multiple thereof.



# BETA Measuring Three-Phase Measuring Devices

## 7KT1 39 LAN couplers

### Overview

A LAN coupler supports the worldwide data recall of up to 10 multiconverters and E-counters over a LAN link to the Internet.

The LAN coupler is used in conjunction with multiconverters and E-counters. Up to 10 devices can be linked with a LAN coupler. In turn, the LAN coupler is connected to a LAN.

Data communication between the LAN coupler and the PC takes place using the TCP/IP protocol.

The supplied software can be used to call up the measured data over LAN coupler and transfer it to a PC. The measured data are continuously stored as a text file with time and date stamp. This gives users great flexibility in designing their own solutions (e. g. the data can be prepared using MS Excel).

### Benefits

- Integration of measuring devices in industrial or office communication
- Display of measured data using the standard software MS Excel
- Use of existing local networks (LAN) for transmitting the measured data
- TCP/IP data protocol enables a wide range of applications
- Limit value signals with time information for all measured values increases your plant's safety
- Open software structure enables the implementation of customized solutions for measured data indication and analysis
- Worldwide communication of the measured values via LAN
- One LAN coupler for 10 devices

### Selection and ordering data

	U <sub>c</sub>	MW	DT	Order No.	Price per PU	PU	PS*	PG	Weight per PU approx.
	V AC					Unit(s)	Unit(s)		kg
 <p><b>LAN couplers</b> For connection of up to 10 devices over RS485 Software tools included for:</p> <ul style="list-style-type: none"> <li>• Installation and commissioning</li> <li>• Data transmission and storage</li> <li>• MS Excel macro for visualization of measured data</li> </ul>	230	4	B	<b>7KT1 390</b>		1	1	027	0.232

### More information

#### Connection of the LAN coupler to a LAN

Each station in a LAN must be assigned its own IP address. On delivery, or after a reset, the LAN coupler has a standard IP address. The new IP address must be set in the LAN coupler during start-up. To do this, the LAN coupler must be directly connected to a PC using a so-called "cross-over" cable. This is a network cable in which the transmit and receive wires are cross-connected. This creates a small LAN with 2 stations, PC and LAN coupler can communicate with each other directly. The supplied LAN coupler configuration tool must be installed on the PC. This direct connection can then be used to set a new IP address in the LAN coupler, as well as other network parameters, such as subnet mask and default gateway. The LAN coupler must then be connected to the target system as communication is subsequently only possible with the new settings.

#### Connection of measuring devices to the LAN coupler

E-counters and multiconverters are connected to the LAN couplers over their communication interface. The network is an RS 485 network in which devices are connected over a shielded 2-wire cable. When using Modbus, the device address and transmission rate must be set in the multiconverters. This is not necessary if using the multiconverters and E-counters over the LAN coupler, as the LAN coupler automatically detects and identifies any connected E-counters and multiconverters. You can now use the LAN coupler configuration tool (over the LAN network) to tell the LAN coupler from which device you want to retrieve the measured data.

The LAN coupler carries out a so-called "polling" during runtime. This cyclically retrieves the most recently gathered measured data from the measuring devices and buffers them in the LAN coupler. This can then be called up at any time over the LAN.

\* You can order this quantity or a multiple thereof.

# BETA Measuring Three-Phase Measuring Devices

## 7KT1 39 LAN couplers

### Data transmission from LAN coupler to PC

This data transmission is PC-controlled. A software tool runs in the background on the PC and uses the network to cyclically retrieve any measured data from all available LAN couplers and save it to the hard disk.

### Software tool

- The supplied software tool has the following functions:
- Background transmission of measurement data from multi-counters and E-counters and a number of LAN couplers
  - Full display of device measured data through a macro based on MS Excel
  - Adjustable limit value signals for measured quantities
  - Violations of limit values are signaled with time stamp.

You will find further information on Modbus operation on the Internet at: [www.siemens.com/beta](http://www.siemens.com/beta)

### Display of measured data on the PC

A Visual Basic macro for MS Excel is supplied with the LAN coupler for the display of measured data on a PC. Among other things, this software tool lets you display all 35 measured data of a 7KT1 34 multimeter on a single panel. You can then select the various measuring devices you want to display from a small list box. The software also lets you set alarm limits for up to 10 measured quantities of a multimeter.

If a measured value exceeds or falls below the specified limits, the relevant indication is output, complete with time stamp from the PC clock.

Messwert	Anzeige	Einheit	Zuordnung	Wert	Stoher	Alarmgrenzen	Verzögerung	Alarm	Wert
7	Wirkleistung	1	W	L1	156430				
8	Spannung	1	V	L1	225				
9	Strom	1	A	L1	845				
10	Scheinleistung	1	VA	L1	187648				
11	cos φ	1	cosφ	L1	0,96				
12	Spannung	1	V	L1,3	405				
13	Wirkleistung	2	W	L2	164423				
14	Spannung	2	V	L2	225				
15	Strom	2	A	L2	798				
16	Scheinleistung	2	VA	L2	169924				
17	cos φ	2	cosφ	L2	11,00				
18	Spannung	2	V	L2,3	13487				
19	Wirkleistung	3	W	L3	45				
20	Spannung	3	V	L3	1987				
21	Strom	3	A	L3	65				
22	Scheinleistung	3	VA	L3	219				
23	cos φ	3	cosφ	L3	47,00				
24	Spannung	3	V	L3,1	438				
25	Wirkleistung	4	W	ZL	2221				
26	Scheinleistung	4	VA	ZL	11				
27	Blindleistung	4	VAR	ZL	3714				
28	Frequenz	5	Hz	ZL	50				
29	cos φ	1,2,3,5	cosφ	ZL	1781,00				

Display of measured data of a multimeter

### Simultaneous display of measured data on more than one PC

The software supplied with the LAN coupler supports display of measured data on any number of PCs connected to the network over a client-server architecture.

A PC acts as the server, similar to an Intranet or Internet server. This PC runs the software components that retrieve the measurement data from the LAN coupler and save it to hard disk. The MS Excel macro can be used to visualize the measured data on both the server PC and the clients.

Other client PCs can access the data pool of the server PC to visualize the measured data.

### Open software architecture

The architecture of the software tool is open and can be customized to suit user requirements. The MS Excel macros are freely accessible and can also be customized by the user.

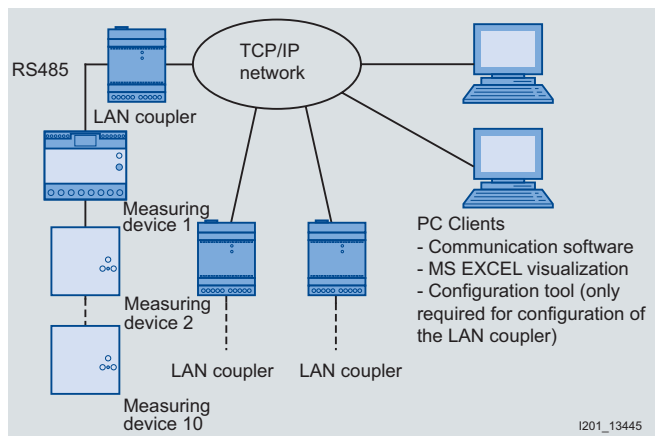

Block diagram of a system

# BETA Measuring Three-Phase Measuring Devices

7KT1 5 E-counters

## Overview

The E-counters (power meters) are used to record the amount of electrical energy exported or imported. Siemens compact E-counters are designed as modular devices for alternating current and can be mounted on standard mounting rails. They comply with the counter standard EN 50470-1 and -3 and come with an LCD.

The three-phase counters are available for direct connection up to 80 A and also in versions with transformer connection (.../5 A to 10000/5 A).

The E-counters store both active energy and reactive energy and they all comply with accuracy class 1 (for active energy).

All E-counters have a pulse output (S0) and are designed for 2 tariff measurements. The calibrated versions are in accordance with the new Measuring Instruments Directive 2004/22/EC (MID).

At the same time the E-counters have an integrated optical interface (IrDA) for connecting communication modules. Integration of the E-counters, e. g. in energy management systems, is thus possible.

For single-phase E-counters see page 19/141.

## Benefits

- Compliant with the new counter standard EN 50470-1 and -3
- Easy-to-read LCD
- Versions calibrated in accordance with the new Measuring Instruments Directive 2004/22/EC (MID) can be used for invoicing purposes
- Exact recording thanks to accuracy class 1 (for active energy)



- Direct connection up to 80 A, transformer current connection .../5 A



- Sealable terminal covers

## Selection and ordering data

	$U_e$	$I_e$	$U_c$	MW	DT	Order No.	Price per PU	PU	PS*	PG	Weight per PU approx.
	V AC	A AC	V AC					Unit(s)	Unit(s)		kg
 <b>Digital three-phase E-counters</b> For direct connection, double rate For direct connection, double rate, calibrated version For transformer connection, double rate	230	80	230	4	B	<b>7KT1 543</b>		1	1	027	0.386
	230	80	230	4	B	<b>7KT1 545</b>		1	1	027	0.386
	230	Trans-	230	4	B	<b>7KT1 540</b>		1	1	027	0.281
		former /5									

## More information

More information about E-counters can be found in Catalog ET B1 · 2010.

The current issue of the catalog can be downloaded from [www.siemens.com/e-installation-catalogs](http://www.siemens.com/e-installation-catalogs).

\* You can order this quantity or a multiple thereof.

# BETA Measuring Three-Phase Measuring Devices

7KT1 2 current transformers  
7KT9 0 measuring selector switches

## Overview

### 7KT1 2 current transformers

This three-phase current transformer can be used in distribution boards according to DIN 43880. The measuring leads are routed vertically through the standard mounting rail. This type of current transformer is suitable for incoming or outgoing feeders in connection with the installation of a 5TE8 switch or a 5TE1 disconnecter, as the primary connecting leads do not have to be interrupted.

The current transformer is designed for cables of up to 13 mm in diameter, e. g. H07V-R with 50 mm<sup>2</sup> conductor cross-section.

## Benefits

- The current transformer has accuracy class 1 in accordance with EN 60044-1. This value is better than most measuring devices in this area of application.
- The versions designed for a transformer ratio of 60/5 A, 100/5 A and 150/5 A enable an even broader range of applications.

## Selection and ordering data

	$U_e$	$I_e$	$I_{sec}$	MW	DT	Order No.	Price per PU	PU	PS*	PG	Weight per PU approx.
	V AC	A AC	A AC					Unit(s)	Unit(s)		kg
	<b>Current transformers</b>										
	720	3 × 60 3 × 100 3 × 150	5	6	B	<b>7KT1 200</b>		1	1	027	0.460
					B	<b>7KT1 201</b>		1	1	027	0.460
					B	<b>7KT1 202</b>		1	1	027	0.465

## Overview

### 7KT9 0 measuring selector switches



Measuring selector switches are used as CO contacts of the phases for voltages and currents in three-phase systems for voltmeters and ammeters.

The design of these switches is adapted to match the modular installation devices. They support use in compliance with EN 60947-3.

## Benefits

- The devices have a rated insulation voltage of 660 V. This permits use in many systems.

## Selection and ordering data

	$U_e$	$I_e$	$U_c$	MW	DT	Order No.	Price per PU	PU	PS*	PG	Weight per PU approx.
	V AC	A AC	V AC					Unit(s)	Unit(s)		kg
	<b>Voltmeter selector switches</b>										
	400	12	6	3	A	<b>7KT9 010</b>		1	1/48	027	0.110
	<b>Ammeter selector switches for operation with current transformer</b>										
	400	12	6	3	A	<b>7KT9 011</b>		1	1	027	0.110

# BETA Measuring Single-Phase Measuring Devices

## 7KT1 53, 7KT1 14 E-counters

### Overview

The E-counters (power meters) are used to record the amount of electrical energy exported or imported. Siemens compact E-counters are designed as modular devices for alternating current and can be mounted on standard mounting rails. They comply with the counter standard EN 50470-1 and -3 and come with an LCD.

The single-phase counters are available for direct connection up to 80 A. They store both active energy and reactive energy and they all comply with accuracy class 1 (for active energy).

All E-counters have a pulse output (S0) and are designed for 1-tariff or 2-tariff measurements depending on the version. The calibrated versions are in accordance with the new Measuring Instruments Directive 2004/22/EC (MID).

At the same time the E-counters have an integrated optical interface (IrDA) for connecting communication modules. Integration of the E-counters, e. g. in energy management systems, is thus possible.

For three-phase E-counters see page 19/139.

### Benefits

#### Digital 7KT1 53. E-counters

- Compliant with the new counter standard EN 50470-1 and -3
- Easy-to-read LCD
- Versions calibrated in accordance with the new Measuring Instruments Directive 2004/22/EC (MID) can be used for invoicing purposes
- Exact recording thanks to accuracy class 1 (for active energy)
- Sealable terminal covers





- Direct connection up to 80 A

#### 7KT1 140 E-counters for active energy

- The drum-type register with digit size 4 mm × 1.2 mm enables easy reading
- The short-circuit proof pulse output protects the device if it is assembled incorrectly.

### Selection and ordering data

	$U_e$	$I_e$	$U_c$	MW	DT	Order No.	Price per PU	PE	PS*/P. unit	PG	Weight per PU approx.
	V AC	AC A	V AC					Unit(s)	Unit(s)		kg
	<b>Digital single-phase E-counters</b>										
	• For direct connection, single rate										
					4	B	<b>7KT1 530</b>		1	1	027
• For direct connection, double rate											
				4	B	<b>7KT1 531</b>		1	1	027	0.164
• For direct connection, double rate, calibrated version											
		80		4	B	<b>7KT1 533</b>		1	1	027	0.164
	<b>E-counters for active energy</b>										
	With 7-digit drum-type register 4 mm × 1.2 mm with S0 interface, for single-phase operation										
Direct connection, single rate											
	230	80	230	2	B	<b>7KT1 140</b>		1	1	027	0.400

### More information

More information about E-counters can be found in Catalog ET B1 · 2010. The current issue of the catalog can be downloaded from [www.siemens.com/e-installation-catalogs](http://www.siemens.com/e-installation-catalogs)

\* You can order this quantity or a multiple thereof.

# BETA Measuring Single-Phase Measuring Devices

7KT1 11, 7KT1 12 digital measuring devices  
7KT1 0 analog measuring devices

## Overview

### 7KT1 11, 7KT1 12 digital measuring devices



These devices for measuring voltages and currents can be used for monitoring incoming and outgoing currents or device currents in electric plants. They are suitable for direct connection in a single-phase system or with measuring transducers in three-phase systems.

The measuring ranges of the ammeter are set at the device with a coding switch.

## Benefits

- The ammeters have 14 measuring ranges from 0 ... 20 A to 0 ... 999 A, which can be set using a coding switch. This ensures universal application.

## Selection and ordering data

	$U_e$	$I_e$	$U_c$	MW	DT	Order No.	Price per PU	PE	PS*/P. unit	PG	Weight per PU approx.
	V AC	AC A	V AC					Unit(s)	Unit(s)		kg
	<b>Digital voltmeters</b>										
	230	600			2 B	<b>7KT1 110</b>		1	1	027	0.190
	<b>Digital ammeters for direct and current transformer connection</b>										
	230		0 ... 20 transformers/5		2 B	<b>7KT1 120</b>		1	1	027	0.200

## More information

More information about digital measuring devices can be found in Catalog ET B1 · 2010.

The current issue of the catalog can be downloaded from [www.siemens.com/e-installation-catalogs](http://www.siemens.com/e-installation-catalogs)

## Overview

### 7KT1 0 analog measuring devices

These devices for measuring voltages and currents can be used for monitoring incoming and outgoing currents or device currents in electric plants. They are suitable for direct connection in a single-phase system or with measuring transducers in three-phase systems.

## Benefits

- The 7KT1 020 ammeter can be equipped with changeable scales for primary currents of 60, 150 or 400 A AC, depending on the transformer ratio of the installed current transformer. The changeable scales are included in the scope of delivery. This ensures universal application.
- Permanent overload up to 20 % does not damage the device. This means safety for your plant.

## Selection and ordering data

	$U_{meas}$	$I_{meas}$	MW	DT	Order No.	Price per PU	PE	PS*/P. unit	PG	Weight per PU approx.
	V AC	AC A					Unit(s)	Unit(s)		kg
	<b>Analog voltmeters</b>									
	500			4 B	<b>7KT1 000</b>		1	1	027	0.105
	<b>Analog ammeters for direct connection</b>									
		25		4 B	<b>7KT1 010</b>		1	1	027	0.110
		40		B	<b>7KT1 011</b>		1	1	027	0.125
		60		B	<b>7KT1 012</b>		1	1	027	0.135
	<b>Analog ammeters for current transformer connection with 3 different interchangeable scales</b>									
	0 ... 60 A, 0 ... 150 A and 0 ... 400 A	0 ... 60/5 0 ... 150/5 0 ... 400/5		4 B	<b>7KT1 020</b>		1	1	027	0.105

\* You can order this quantity or a multiple thereof.

# BETA Measuring Single-Phase Measuring Devices

## 7KT5 8 time and pulse counters

### Overview

Time and pulse counters are used for the reliable monitoring of production and service times, which enables the exact planning and monitoring of production sequences, maintenance cycles and warranty times.





As well as the proven electromechanical time and pulse counters for mounting in distribution boards, we also supply digital time and pulse counters.

The fields of application for both counter types are very diverse, such as the recording of operating hours of machines, systems or building management systems, as well as pulse counting for general volume flow counting, registration of starting frequencies, starting cycles or production quantities in systems and machines.

### Benefits

- Time and pulse counters help to plan maintenance intervals and ensure high plant availability.
- Versions without zero position and with electric or manual zero position for all applications.
- Flexible application of the digital counters for control supply voltages of 12 to 150 V DC and 24 to 240 V AC in a single device.

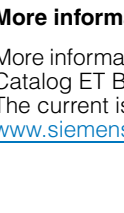
### Selection and ordering data

	$U_c$	Fre- quency	MW	DT	Order No.	Price per PU	PE	PS*/ P. unit	PG	Weight per PU approx.	
	V	Hz					Unit(s)	Unit(s)		kg	
	<b>Time counters</b>										
	Mechanical counting mechanism, display 00000.00 h without resetting										
	12 ... 24	--	2	A	<b>7KT5 801</b>		1	1	027	0.095	
	24 AC	50		A	<b>7KT5 802</b>		1	1	027	0.095	
	115 AC			B	<b>7KT5 803</b>		1	1	027	0.095	
	230 AC			A	<b>7KT5 804</b>		1	1	027	0.095	
115 AC	60		B	<b>7KT5 806</b>		1	1	027	0.095		
230 AC			B	<b>7KT5 807</b>		1	1	027	0.095		
	<b>Pulse counters</b>										
	Mechanical counting mechanism, display 0000000 _ _ _ without zero position										
	12 ... 24	--	2	B	<b>7KT5 811</b>		1	1	027	0.095	
	24 AC	50/60		B	<b>7KT5 812</b>		1	1	027	0.095	
230 AC			B	<b>7KT5 814</b>		1	1	027	0.095		
	<b>Electronic time counters</b>										
	LCD 000000.0 h without zero position										
	12 ... 150 DC,	--	2	B	<b>7KT5 821</b>		1	1	027	0.080	
	24 ... 240	50/60									
	with electrical resetting										
	12 ... 150 DC,	--		B	<b>7KT5 822</b>		1	1	027	0.080	
24 ... 240	50/60										
with electrical and mechanical resetting											
12 ... 150 DC,	--		B	<b>7KT5 823</b>		1	1	027	0.080		
24 ... 240	50/60										
	<b>Electronic pulse counters</b>										
	LCD display 0000000 _ _ _ with electrical and mechanical resetting										
12 ... 150 DC,	--	2	B	<b>7KT5 833</b>		1	1	027	0.080		
24 ... 240	50/60										

### More information

More information about time and pulse counters can be found in Catalog ET B1 · 2010.

The current issue of the catalog can be downloaded from [www.siemens.com/e-installation-catalogs](http://www.siemens.com/e-installation-catalogs)

# BETA Measuring Single-Phase Measuring Devices

## 7KT5 5, 7KT5 6 time counters for front mounting

### Overview



Time and pulse counters for control cabinets, control and mechanical engineering are used, e. g. in boilers, machine tools or compressors. The pulse counters count the starting frequencies. This supports planning for preventative maintenance.

In-time and regular maintenance is the best protection against unexpected shutdowns.

### Benefits

- Time and pulse counters help to plan maintenance intervals and ensure high plant availability.

### Selection and ordering data

	$U_c$	Fre- quency	MW	DT	Order No.	Price per PU	PE	PS*/ P. unit	PG	Weight per PU approx.		
	V	Hz					Unit(s)	Unit(s)		kg		
	<b>Time counters</b>											
	Mechanical counting mechanism, display 00000.00 h, for front-panel mounting, front frame 48 mm x 48 mm											
	10 ... 80	–		A	<b>7KT5 500</b>		1	1	027	0.045		
	24 AC	50		A	<b>7KT5 505</b>		1	1	027	0.045		
	115 AC			A	<b>7KT5 501</b>		1	1	027	0.045		
	230 AC			A	<b>7KT5 502</b>		1	1	027	0.045		
	115 AC	60		A	<b>7KT5 503</b>		1	1	027	0.045		
	230 AC			A	<b>7KT5 504</b>		1	1	027	0.045		
		For front-panel mounting, front frame 72 mm x 72 mm with narrow frame according to DIN 43700										
		10 ... 50	–	2	B	<b>7KT5 600</b>		1	1	027	0.120	
115 AC		50		B	<b>7KT5 601</b>		1	1	027	0.120		
230 AC				A	<b>7KT5 602</b>		1	1	027	0.120		
115 AC		60		B	<b>7KT5 603</b>		1	1	027	0.120		
230 AC				B	<b>7KT5 604</b>		1	1	027	0.120		
<b>Covers for 7KT5 5 time counters</b>												
55 mm x 55 mm				B	<b>7KT9 020</b>		1	1	027	0.015		
<b>Sealing rings for 7KT9 020 covers</b>												
IP43 installation in switchboards with smooth surfaces (1 set = 5 units)				C	<b>7KT9 000</b>		1 set	1 set	027	0.020		
<b>Terminal covers for 7KT5 6 time counters</b>												
Degree of protection IP20 with connected conductors				B	<b>7KT9 021</b>		1	1	027	0.010		