

CÔNG TY CỔ PHẦN CÔNG NGHỆ HỢP LONG

Variable speed drives Altivar 312

For 3-phase motors from 0.18 to 15 kW

Catalogue

May 2011



Schneider
Electric

Hotline: 1900.6536 - Website: HOPLONGTECH.COM

- Brochure page 2
- Catalogue page 11



INDUSTRIAL AUTOMATION

Altivar 312 range

Designed for robustness and compatibility with the control system architectures of your machines

User-friendly + Open
Compatible + Economical

Enhanced communication:

- CANopen Daisy Chain, DeviceNet, Profibus DP

Simplified user interface:

- Setup via mobile phone (Bluetooth®)
- Intuitive navigation
- Local control on the front panel

Numerous application-specific functions

Auto-tuning for maximum performance

Integrated EMC filter

Rugged for use in all environments

Increased performance for industrial machines



INDUSTRIAL AUTOMATION

- Materials handling and packaging
- Packing
- Textile machines
- Special machines
- Pumps and fans



Up to 30 % more performance

compared to the market average



INDUSTRIAL AUTOMATION

Des fonctionnalités singulières à chaque type de machine



Materials handling

- +/- speed
- Brake sequence
- Motor switching
- Management of limit switches
- Switching frequency up to 16 kHz
- Current limitation
- Linear ramps, S, U or customised
- Second ramp



Packaging and packing

- Brake sequence
- Output contactor control
- Accessible DC bus



Special machines

- Current limitation
- Catch on the fly
- Controlled stop on loss of line supply
- Derated operation



Textile machines

- 16 preset speeds
- +/-10V bipolar input reference
- PI regulator



Pumps, ventilation

- PI regulator and reference, automatic/manual
- Automatic restart
- Stop modes in the event of a fault
- Limitation of low speed operating time
- Detection of current, torque and thermal state thresholds of drive and motor

Other options

- Protection of machine by locking parameters
- Multiple assignment of logic inputs
- Saving a set of parameters
- Management of external faults
- Display of parameters: current, power, torque, speed, frequency, etc.



50 application-specific functions listed in the catalogue

Simplicity to boost the performance of your machines

Local control on the front panel

Ergonomically designed button for simple navigation

Run/Stop commands on the device

Snap-lock seal

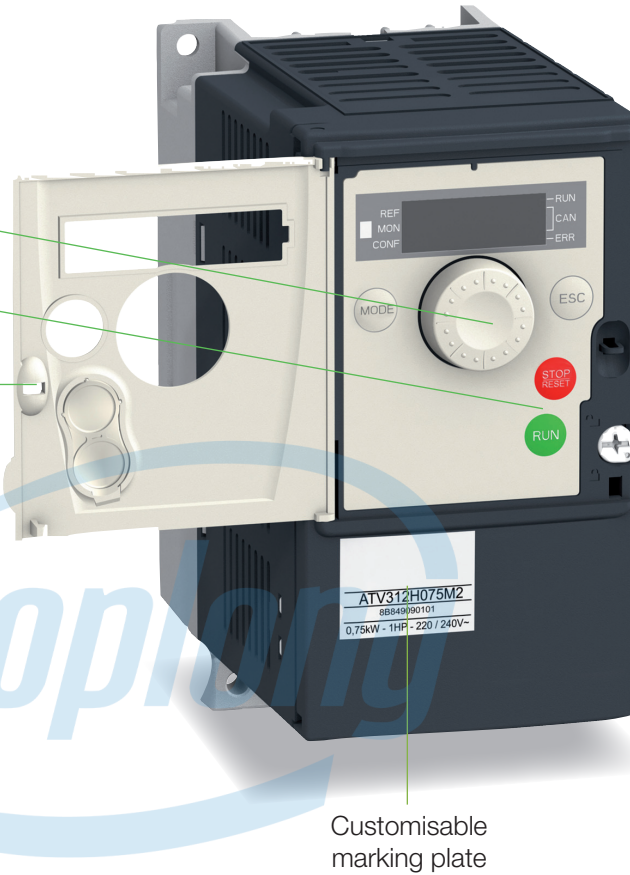

Customisable marking plate



Universal communication tools and networks for your control system architectures via the RJ45 port.

Increased productivity

- Reduced design and installation costs thanks to the SoMove software workshop
- Auto-tuning saves setup time and optimises performance
- Full mechanical and software compatibility with the Altivar 31 in event of replacement
- The compact size means smaller enclosures (integrated EMC filter and side-by-side mounting without derating)

Remote HMI terminals



- Same as Altivar 61 and 71
- Plain text in your language



- Same as Altivar 12
- LED display

Communication with your control system architectures

One connection, one software tool to programme the PLC and configure the drives

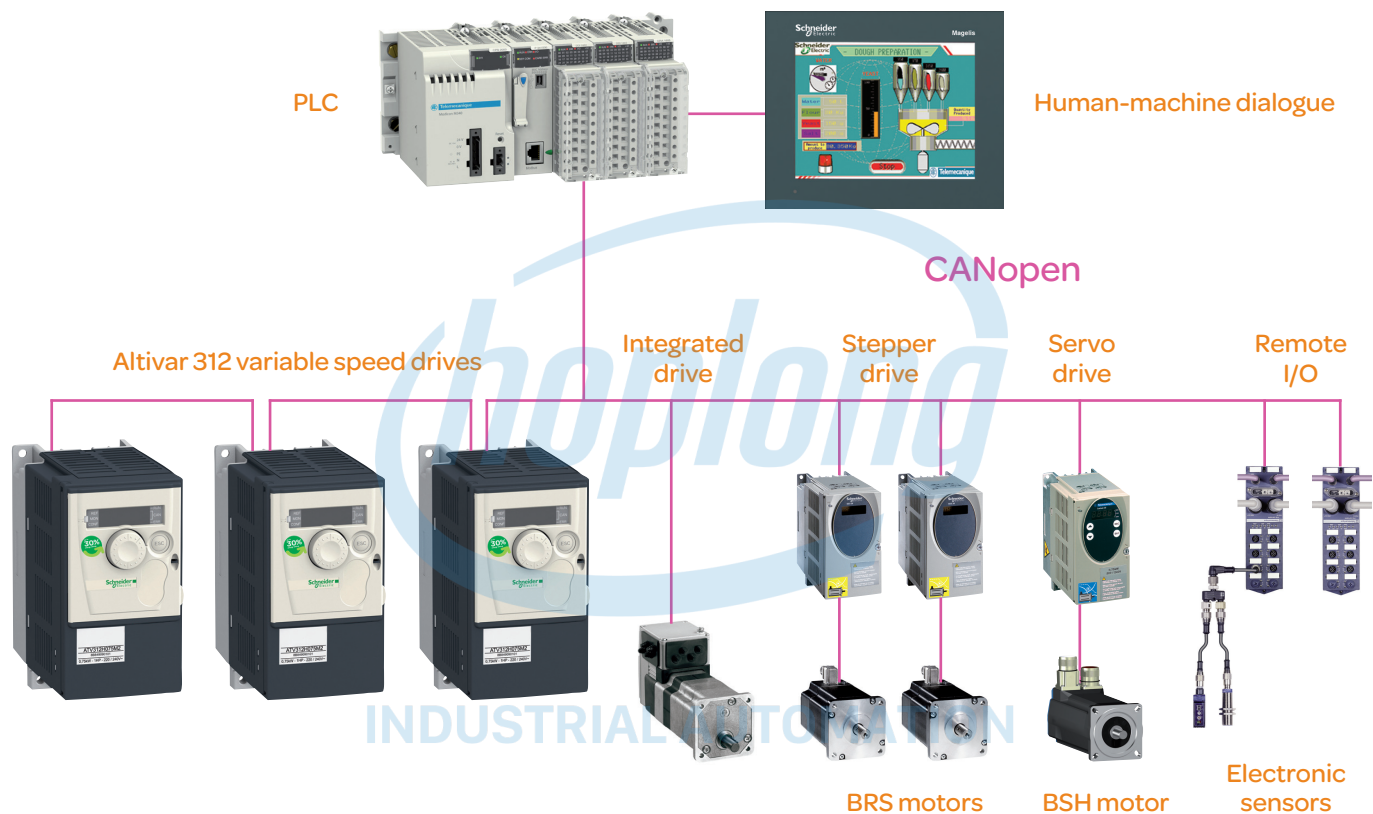

Altivar 312 integrates transparently into your architectures and communicates with all control system products:

- Modbus and CANopen are integrated as standard
- Option cards: CANopen Daisy Chain, DeviceNet, Profibus DP
- Gateways for Ethernet/Modbus and Fipio/Modbus



A global range with universal product references:

Altivar 312 accompanies your machines wherever they travel in the world.

User-friendliness expressed through dialogue

A common platform

Duplicate the configuration using the many common tools available for Altivar and Lexium series 2: Simple Loader, Multi-Loader, graphic interface, SoMove software workshop, Bluetooth interface and mobile phone software.

Preparation of files

The SoMove software workshop enables the design office to prepare the files for drive configuration. 2 methods for loading the configuration:

- Direct from PC to drive using a USB/RJ45 cable
- Without a PC, via an SD memory card using Multi-Loader

Equipment testing

The SoMove software workshop serves as a dynamic debugging tool for your machine. The oscilloscope function is extremely useful when making adjustments.

Multi-Loader configuration tool

The configurations of several drives are stored on a standard SD memory card. Simply load it directly into your PC or insert into the Multi-Loader, which can be used as a card reader.

Simple Loader duplication tool

Copy the settings from a configured drive and duplicate on all your machines.

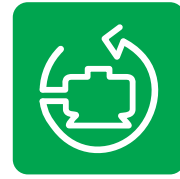

SoMove
Software workshop



Save Time

when setting up the device: using Multi-Loader, you can select and transfer the required file in a matter of seconds.



Use your mobile to configure your Altivar 312

Efficiency

with an all-in-one solution

- Download and transfer configurations
- Drive adjustment and maintenance
- Send and receive configuration files locally or remotely in a matter of seconds

Safety

and confidentiality

- Monitor and adjust your machine from a secure location
- Bypass all the usual physical and security constraints to access your machines via the Bluetooth wireless connection. You don't even need to open the enclosure!
- Save changes or reinstall saved configurations whenever you want

Simplicity

and comfort

- Work in comfort using Bluetooth wireless communication. Take advantage of the user-friendly SoMove Mobile™ dialogue functions
- You know which menu you are in at any time
- Share configuration files via MMS or email



INDUSTRIAL AUTOMATION



Altivar Innovation

Remote configuration to update settings by mobile or PC via Bluetooth.

A wide range of products meeting safety and international standards

A robust legacy

- All the advantages of Altivar 31
- Excellent resistance to harsh environments (50°)
- Coated cards as standard (IEC 60721-3-3 Classes 3C2 and 3S2)
- Excellent resistance to power supply and motor interference

Large voltage range

- Single-phase 200 to 240 V with an integrated C2 EMC filter and optional C1 filter
- Three-phase 200 to 240 V
- Three-phase 380 to 500 V with integrated C2 EMC filter
- Three-phase 525 to 600 V

Compliance with specific requirements

- Integrated Class 2 EMC filter for radiated and conducted emissions
- Local control integrated in the drive (programmable)
- Positive and negative logic
- DIN rail mounting
- UL Type 1 kit

Standards and certifications

EC/EN 61800-5-1, IEC/EN 61800-3 (environments 1 and 2, C1 to C3), CE, UL, CSA, C-Tick, NOM, GOST

INDUSTRIAL AUTOMATION



Variable speed drives Altivar 312

- **Selection guide** page 12
- **Presentation** page 18
- **Altivar 312 variable speed drives**
 - **Characteristics** page 20
 - **References** page 26
- **Options**
 - **Communication buses and networks** page 28
 - **Dialogue tools** page 34
 - **Configuration tools** page 35
 - **Braking resistors** page 40
 - **Line chokes** page 42
 - **Additional EMC input filters** page 44
 - **Output filters and motor chokes** page 46
- **SoMove setup software** page 36
- **Dimensions** page 48
- **Schemes** page 54
- **Mounting and installation recommendations** page 56
- **Motors starters** page 58
- **Functions** page 60

INDUSTRIAL AUTOMATION

Selection guide CÔNG TY CỔ PHẦN CÔNG NGHỆ HOPLONG

IP 20 or IP 21 variable speed drives for asynchronous and synchronous motors

Type of machine		Simple machines		Pumps and fans (building (HVAC)) (1)
				
Power range for 50...60 Hz (kW) line supply		0.18...4	0.18...15	0.75...75
Single-phase 100...120 V (kW)		0.18...0.75	–	–
Single-phase 200...240 V (kW)		0.18...2.2	0.18...2.2	–
Three-phase 200...230 V (kW)		–	–	–
Three-phase 200...240 V (kW)		0.18...4	0.18...15	0.75...30
Three-phase 380...480 V (kW)		–	–	0.75...75
Three-phase 380...500 V (kW)		–	0.37...15	–
Three-phase 500...600 V (kW)		–	–	–
Three-phase 525...600 V (kW)		–	0.75...15	–
Three-phase 500...690 V (kW)		–	–	–
Degree of protection		IP 20	IP 21	
Type of cooling		Heatsink		
Drive	Output frequency	0.1...400 Hz	0.1...500 Hz	0.5...200 Hz
	Type of control	Asynchronous motor	Standard (voltage/frequency) Performance (sensorless flux vector control) Pump/fan (Kn ² quadratic ratio)	Standard (voltage/frequency) Performance (sensorless flux vector control) Energy saving ratio
		Synchronous motor	–	–
	Transient overtorque	150...170% of the nominal motor torque	170...200% of the nominal motor torque	120% of the nominal motor torque
Functions				
Number of functions		40	50	50
Number of preset speeds		8	16	7
Number of I/O	Analog inputs	1	3	2
	Logic inputs	4	6	3
	Analog outputs	1	1	1
	Logic outputs	1	–	–
	Relay outputs	1	2	2
Communication		Integrated	Modbus and CANopen	Modbus, METASYS N2, APOGEE FLN, BACnet
	Available as an option	–	CANopen Daisy Chain, DeviceNet, PROFIBUS DP, Modbus TCP, Fipio	LonWorks
Cards (available as an option)		–	–	–
Dialogue tools		IP 54 or IP 65 remote terminal	IP 54 or IP 65 remote terminal IP 54 remote graphic display terminal	IP 54 or IP 65 remote graphic display terminal
Configuration tools	Setup software	SoMove		PCSoft for ATV 212
	Configuration tools	Simple Loader, Multi-Loader		Multi-Loader
Standards and certifications		IEC 61800-5-1 IEC 61800-3 (environments 1 and 2, categories C1 to C3, cat. C1 with option for ATV 212)	CE, UL, CSA, DNV, C-Tick, NOM, GOST	EN 55011: Group 1, class A and class B with option card. CE, UL, CSA, C-Tick, NOM
References		ATV 12	ATV 312	ATV 212
Catalogues		"Altivar 12 variable speed drives"	Page 26	"Altivar 212 variable speed drives"

(1) Heating, Ventilation and Air Conditioning



More technical information on www.schneider-electric.com

Hotline: 1900.6536 Website: HOPLONGTECH.COM

Pumps and fans (industrial)



Complex machines



0.37...800

–
0.37...5.5
–
0.75...90
0.75...630
–
2.2...7.5
–
2.2...800

IP 20

Heatsink or water-cooled system

0.1...500 Hz for the entire range
0.1...599 Hz up to 37 kW at 200...240 V ~ and 380...480 V ~
Sensorless flux vector control
Voltage/frequency ratio (2 or 5 points)
Energy saving ratio

Vector control without speed feedback
120% of the nominal motor torque for 60 seconds

> 100

8

2...4

6...20

1...3

0...8

2...4

Modbus and CANopen

Modbus TCP Daisy Chain, Modbus/Uni-Telway, EtherNet/IP, DeviceNet, PROFIBUS DP V0 and V1, INTERBUS, CC-Link, LONWORKS, METASYS N2, APOGEE FLN, BACnet

I/O extension cards, "Controller Inside" programmable card, multi-pump cards, encoder interface cards

IP 54 or IP 65 remote graphic display terminal

SoMove

Simple Loader, Multi-Loader

IEC 61800-5-1

IEC 61800-3 (environments 1 and 2, categories C1 to C3), IEC 61000-4-2/4-3/4-4/4-5/4-6/4-11

CE, UL, CSA, DNV, C-Tick, NOM, GOST

ATV 61

"Altivar 61 variable speed drives"

0.37...630

–
0.37...5.5
–
0.37...75
0.75...500
–
1.5...7.5
–
1.5...630

Heatsink, base plate or water-cooled system

0.1...500 Hz for the entire range
0.1...599 Hz up to 37 kW at 200...240 V ~ and 380...480 V ~
Flux vector control with or without sensor
Voltage/frequency ratio (2 or 5 points)
ENA System

Vector control with or without speed feedback
220% of the nominal motor torque for 2 seconds
170% for 60 seconds

> 150

16

2...4

6...20

1...3

0...8

2...4

Modbus TCP Daisy Chain, Modbus/Uni-Telway, EtherNet/IP, DeviceNet, PROFIBUS DP V0 and V1, INTERBUS, CC-Link

Interface cards for incremental, resolver, SinCos, SinCos Hiperface®, EnDat® or SSI encoders, I/O extension cards, Controller Inside programmable card

ATV 71

"Altivar 71 variable speed drives"



More technical information on www.schneider-electric.com

Hotline: 1900.6536 - Website: HOPLONGTECH.COM



Selection guide CÔNG TY CỔ PHẦN CÔNG NGHỆ HOPLONG IP 54 or IP 55 variable speed drives for asynchronous and synchronous motors

Type of machine		Simple machines	Pumps and fans (building (HVAC)) (1)
			
Power range for 50...60 Hz (kW) line supply		0.18...15	0.75...75
Single-phase 200...240 V (kW)		0.18...2.2	–
Three-phase 380...480 V (kW)		–	0.75...75
Three-phase 380...500 V (kW)		0.37...15	–
Degree of protection		IP 55	IP 55
Variants		Enclosure user-definable up to 4 kW: Vario switch disconnecter, LEDs, selector switch, potentiometer	–
Drive	Output frequency	0.1...500 Hz	0.1...200 Hz
	Type of control	Asynchronous motor	Sensorless flux vector control Voltage/frequency ratio (2 points) Energy saving ratio
		Synchronous motor	–
	Transient overtorque	170...200% of the nominal motor torque	120% of the nominal motor torque for 60 seconds
Functions			
Number of functions		50	50
Number of preset speeds		16	7
Number of I/O	Analog inputs	3	2
	Logic inputs	6	3
	Analog outputs	1	1
	Logic outputs	–	–
	Relay outputs	2	2
Communication			
Integrated		Modbus and CANopen	Modbus, METASYS N2, APOGEE FLN, BACnet
Available as an option		Modbus TCP, Fipio, PROFIBUS DP, DeviceNet	LonWorks
Cards (available as an option)		–	–
Dialogue tools		IP 65 remote terminal	IP 54 or IP 65 remote graphic display terminal
Configuration tools	Setup software	SoMove	PCSoft for ATV 212 drive
	Configuration tool	Simple Loader	Multi-Loader
Standards and certifications		IEC 61800-5-1, IEC 61800-3 (environments 1 and 2, categories C1 to C3) CE, UL, CSA, C-Tick, GOST	
References		ATV 31C	ATV 212W
Catalogues		"Altivar 31C variable speed drives"	"Altivar 212 variable speed drives"

(1) Heating, Ventilation and Air Conditioning



More technical information on www.schneider-electric.com

Hotline: 1900.6536 Website: HOPLONGTECH.COM

Pumps and fans (industrial)



0.75...90

0.75...90

IP 54

Equipped with a Vario switch disconnecter

0.1...599 Hz from 0.75 to 45 kW
0.1...500 Hz from 55...90 kW

Sensorless flux vector control
Voltage/frequency ratio (2 or 5 points)
Energy saving ratio

Vector control without speed feedback
110% of the nominal motor torque for 60 seconds

>100

8

2...4

6...20

1...3

0...8

2...4

Modbus and CANopen

Modbus TCP Daisy Chain, Modbus/Uni-Telway, EtherNet/IP, DeviceNet, PROFIBUS DP V0 and V1, INTERBUS, CC-Link, LONWORKS, METASYS N2, APOGEE FLN, BACnet

I/O extension cards, "Controller Inside" programmable card, multi-pump cards, encoder interface cards

IP 54 or IP 65 remote graphic display terminal

SoMove

Simple Loader, Multi-Loader

IEC 61800-5-1, IEC 61800-3 (environments 1 and 2, categories C1 to C3), IEC 61000-4-2/4-3/4-4/4-5/4-6/4-11
CE, UL, CSA, DNV, C-Tick, NOM, GOST

ATV 61W

ATV 61E5

"Altivar 61 variable speed drives"

Complex machines



0.75...75

0.75...75

Equipped with a Vario switch disconnecter

0.1...599 Hz from 0.75 to 37 kW
0.1...500 Hz from 45 to 75 kW

Sensorless flux vector control
Voltage/frequency ratio (2 or 5 points)
ENA System

Vector control with or without speed feedback
220% of the nominal motor torque for 2 seconds
170% for 60 seconds

>150

16

2...4

6...20

1...3

0...8

2...4

Modbus TCP Daisy Chain, Modbus/Uni-Telway, EtherNet/IP, DeviceNet, PROFIBUS DP V0 and V1, INTERBUS, CC-Link

Interface cards for incremental, resolver, SinCos, SinCos Hiperface®, EnDat® or SSI encoders, I/O extension cards, Controller Inside programmable card

ATV 71W

ATV 71E5

"Altivar 71 variable speed drives"



More technical information on www.schneider-electric.com

Hotline: 1900.6536 - Website: HOPLONGTECH.COM



Variable speed drives

Altivar 61 Plus and Altivar 71 Plus

Integrated solutions

Type of machine

Pumps and fans (industrial)



Power range for 50...60 Hz (kW) line supply

Three-phase 380...415 V
Three-phase 500 V
Three-phase 690 V

90...630	90...800	630...2400
90...630	90...630	630...1400
—	90...630	630...1800
—	110...800	800...2400

Main characteristics

With enhanced protection	With enhanced protection and integrated cooling circuit
--------------------------	---

Variants

Ready to use	Standard offer Modular with integrated options User-definable on request
--------------	--

Drive	Output frequency	0.1...500 Hz
	Type of control	Asynchronous motor
		Synchronous motor
	Transient overtorque	120% of the nominal motor torque for 60 seconds

Sensorless flux vector control Voltage/frequency ratio 2 or 5 points Energy saving ratio
Flux vector control without speed feedback

Communication	Embedded	Modbus and CANopen
	As an option	Modbus TCP, Modbus/Uni-Telway, EtherNet/IP, DeviceNet, PROFIBUS DP V0 and V1, InterBus, CC-Link, LonWorks, METASYS N2, APOGEE FLN, BACnet

Cards (available as an option)

"Controller Inside" programmable card Multi-pump cards

Degree of protection

IP 54 with separate air flows, ATV 61ES5	IP 23 compact version, ATV 61EXC2 IP 54 compact version, ATV 61EXC5 IP 54 with separate air flows, ATV 61EXS5	With integrated air-cooled circuit: IP 23: ATV 61EXA2 IP 54: ATV 61EXA5 With external water-cooled system: IP 55, on request
---	--	---

References

ATV 61 Plus

Catalogues

"Altivar 61 variable speed drives"



More technical information on www.schneider-electric.com

Complex machines (industrial and infrastructure)



90...500	90...630	500...2000
90...500	90...500	500...1300
–	90...500	500...1500
–	110...630	630...2000
With enhanced protection		With enhanced protection and integrated cooling circuit
Ready to use	Standard offer Modular with integrated options User-definable on request	
0.1...500 Hz		
Flux vector control with or without sensor Voltage/frequency ratio (2 or 5 points) ENA System		
Vector control with or without speed feedback		
220% of the nominal motor torque for 2 seconds 170% of the nominal motor torque for 60 seconds		
Modbus and CANopen		
Modbus TCP, Modbus/Uni-Telway, EtherNet/IP, DeviceNet, PROFIBUS DP V0 and V1, InterBus, CC-Link		
"Controller Inside" programmable card		
IP 54 with separate air flows, ATV 71ES5	IP 23 compact version, ATV 71EXC2 IP 54 compact version, ATV 71EXC5 IP 54 with separate air flows, ATV 71EXS5	IP 23, with integrated air-cooled circuit, ATV 71EXA2 IP 54, with integrated air-cooled circuit, ATV 71EXA5 IP 55, with external water-cooled system (on request)

ATV 71 Plus

"Altivar 71 variable speed drives"



More technical information on www.schneider-electric.com

Hotline: 1900.6536 - Website: HOPLONGTECH.COM





Application: packaging



Application: material handling

Presentation

The Altivar 312 drive is a frequency inverter for 200...600 V three-phase asynchronous motors from 0.18 to 15 kW. The Altivar 312 drive is robust, compact and easy to install. Its integrated functions are particularly suitable for the requirements of applications involving simple industrial machines. By taking account of constraints on product setup and use right from the design stage, we are able to offer a reliable, cost-effective solution to manufacturers of simple machines and installers. With its various communication cards that are available as options, the Altivar 312 drive integrates perfectly in the main control system architectures.

Examples of solutions provided:

- Numerous options for loading, editing and saving drive configurations using various tools, such as the SoMove setup software, the SoMove Mobile software for mobile phones, remote display terminals and the Simple Loader and Multi-Loader configuration tools.
- Adaptation to industrial communication buses and networks by simply replacing the drive control I/O card with one of the communication cards
- User interface identical to the Altivar 12 range of variable speed drives, making setup easy and enabling those using it to adapt quickly.

Applications

The Altivar 312 drive incorporates functions that are suitable for the most common applications, including:

- Material handling (small conveyors, hoists, etc.)
- Packing and packaging machines (small bagging machines, labelling machines, etc.)
- Special machines (mixers, kneaders, textile machines, etc.)
- Pumps, compressors, fans

Functions

The Altivar 312 drive has six logic inputs, three analog inputs, one logic/analog output and two relay outputs. The main functions available are as follows:

- Motor and drive protection
- Linear, S, U or customized acceleration and deceleration ramps
- Local control of the speed reference using the navigation button
- +/- speed
- 16 preset speeds
- PI regulator and references
- 2-wire/3-wire control
- Brake sequence
- Automatic catching a spinning load with speed detection and automatic restart
- Fault configuration and stop type configuration
- Saving the configuration in the drive

Several functions can be assigned to one logic input.

An optimized offer

The Altivar 312 range of variable speed drives covers motor power ratings from 0.18 kW to 15 kW with four types of power supply:

- 200 V...240 V single-phase, 0.18 kW to 2.2 kW (ATV 312H...M2)
- 200 V...240 V three-phase, 0.18 kW to 15 kW (ATV 312H...M3)
- 380 V...500 V three-phase, 0.37 kW to 15 kW (ATV 312H...N4)
- 525 V...600 V three-phase, 0.75 kW to 15 kW (ATV 312H...S6)

Several drives can be mounted side by side to save space.

The Altivar 312 drive integrates the Modbus and CANopen communication protocols as standard. The protocols can be accessed via the RJ45 connector on the underside of the drive.

In addition to the Modbus and CANopen protocols that can be accessed as standard, the Altivar 312 drive can be connected to the main industrial communication buses and networks by replacing the drive's control I/O card with one of the communication cards that are available as options: CANopen Daisy chain, DeviceNet and PROFIBUS DP. The Modbus TCP network and the Fipio bus are also accessible via dedicated gateways.

See page 28.



ATV 312H037M3

ATV 312HD15N4

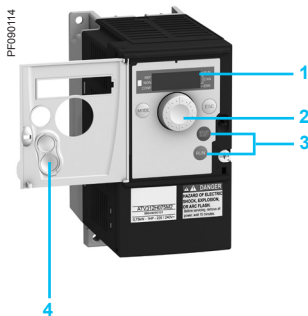

ATV 312H075M2
front panel door open

An optimized offer (continued)

The entire range complies with international standards IEC 61800-5-1, IEC 61800-2 and IEC 61800-3, and UL, CSA, C-Tick, NOM and GOST certifications. It has been developed to meet the requirements of environmental directives (RoHS) and those of the European Directives to obtain the CE mark.

EMC electromagnetic compatibility

The incorporation of EMC filters in **ATV 312H●●●M2** and **ATV 312H●●●N4** drives and compliance with EMC requirements simplify installation and provide a very economical means of ensuring devices meet the criteria to receive the CE mark. This filter can be disconnected via a jumper or a moveable wire with tag. The **ATV 312H●●●M3** and **ATV 312H●●●S6** drives are designed without an EMC filter.

Filters are available as an option and can be installed by the customer to reduce the emission levels of **ATV 312H●●●M2**, **ATV 312H●●●M3** and **ATV 312H●●●N4** drives. See page 44.

External accessories and options

External accessories and options can be used with Altivar 312 drives:

- UL Type 1 conformity kits, plates for direct mounting on 35 mm U-rails, etc.
- Braking resistors, line chokes, additional EMC input filters, output filters, etc.

Dialogue and configuration tools

Human-Machine interface

The 4-digit display **1** displays drive states, faults and parameter values. The navigation button **2** is used to move around the menus, modify values and change the motor speed in local mode. The RUN and STOP/RESET keys **3** are used to control motor starting and stopping in local mode. These two keys can be made accessible on the front panel by removing the cover **4** from the door.

HMI terminals

The Altivar 312 drive can be connected to a remote display terminal or a remote graphic display terminal, which are available as options. The remote display terminal can be mounted on an enclosure door with IP 54 or IP 65 degree of protection. It provides access to the same functions as the Human-Machine interface. The remote graphic display terminal, with its "full text" display in the user's language, provides a user-friendly interface for configuration, debugging or maintenance. See page 34.

SoMove setup software

The SoMove setup software is used to configure, adjust and debug the Altivar 312 drive with the Oscilloscope function, and also for maintenance of this drive, like all other Schneider Electric drives and starters. It can be used with a direct connection or a Bluetooth® wireless connection. See page 35.

SoMove Mobile software for mobile phones

The SoMove Mobile software is used to edit the drive parameters from a mobile phone via a Bluetooth® wireless connection. It can also be used to save configurations. These configurations can be imported or exported from a PC via a Bluetooth® wireless connection. See page 35.

Simple Loader and Multi-Loader tools

The Simple Loader tool enables one powered-up drive's configuration to be duplicated on another powered-up drive. The Multi-Loader tool enables configurations to be copied from a PC or a powered-up drive and duplicated on another powered-up drive. See page 35.



Remote display terminal with cover closed



Remote display terminal with cover open: RUN, FWD/REV and STOP/RESET keys accessible



Remote graphic display terminal



Multi-Loader configuration tool

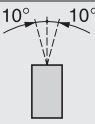

Simple Loader configuration tool

Environmental characteristics			
Conformity to standards			Altivar 312 drives have been developed to conform to the strictest international standards and the recommendations relating to electrical industrial control devices (IEC), in particular: IEC 61800-5-1 (low voltage), IEC 61800-3 (EMC immunity and conducted and radiated EMC emissions).
EMC immunity			IEC 61800-3, Environments 1 and 2 (EMC requirement and specific test methods) IEC 61000-4-2 level 3 (electrostatic discharge immunity test) IEC 61000-4-3 level 3 (radio-frequency radiated electromagnetic field immunity test) IEC 61000-4-4 level 4 (electrical fast transient/burst immunity test) IEC 61000-4-5 level 3 (surge immunity test)
Conducted and radiated EMC emissions for drives	ATV 312H●●●●●		IEC 61800-3, Environments: 2 (industrial power supply) and 1 (public power supply), restricted distribution
	ATV 312H018M2...HU15M2 ATV 312H037N4...HU40N4		IEC 61800-3 category C2 With additional EMC filter (1): ■ IEC 61800-3 category C1
	ATV 312HU22M2, ATV 312HU55N4...HD15N4		IEC 61800-3 category C3 With additional EMC filter (1): ■ IEC 61800-3 category C2 ■ IEC 61800-3 category C1
	ATV 312H018M3...HD15M3		With additional EMC filter (1): ■ IEC 61800-3 category C2
CE marking			The drives are marked CE in accordance with the European low voltage (2006/95/EC) and EMC (2004/108/EC) directives
Product certification			UL, CSA, NOM, GOST, C-Tick and DNV
Degree of protection			IP 31 and IP 41 on upper part and IP 21 on connection terminals
Vibration resistance	Drive not mounted on rail		Conforming to IEC 60068-2-6: 1.5 mm peak to peak from 3 to 13 Hz, 1 gn from 13 to 150 Hz
Shock resistance			15 gn for 11 ms conforming to IEC 60068-2-27
Maximum ambient pollution Definition of insulation			Degree 2 conforming to IEC 61800-5-1
Environmental conditions Use			IEC 60721-3-3 classes 3C2 and 3S2
Relative humidity		%	5...95 non condensing, no dripping water, conforming to IEC 60068-2-3
Ambient air temperature around the device	Operation	°C	- 10...+ 50 without derating - 10...+ 60 with derating removing the protective cover on top of the drive (see derating curves, page 56)
	Storage	°C	- 25...+ 70
Maximum operating altitude	ATV 312H●●●●●	m	1000 without derating
	ATV 312H●●●M2	m	Up to 2000 for single-phase supplies and corner grounded distribution networks, derating the current by 1% for each additional 100 m
	ATV 312H●●●M3 ATV 312H●●●N4 ATV 312H●●●S6	m	Up to 3000 metres for three-phase supplies, derating the current by 1% for each additional 100 m
Operating position Maximum permanent angle in relation to the normal vertical mounting position			

(1) See table on page 45 to check the permitted cable lengths.

Drive characteristics																		
Output frequency range		Hz	0...500															
Switching frequency		kHz	Nominal switching frequency: 4 kHz without derating in continuous operation. Adjustable during operation from 2...16 kHz Above 4 kHz, derate the nominal drive current. The nominal motor current should not exceed this value. See derating curves on page 56															
Speed range			1...50															
Transient overtorque			170...200% of nominal motor torque (typical value)															
Braking torque	With braking resistor	ATV 312H●●●●●	100% of nominal motor torque continuously and up to 150% for 60 s															
	Without braking resistor	ATV 312H018M2 ATV 312H037M2...H075M2 ATV 312H018M3...H075M3 ATV 312H037N4...H075N4 ATV 312H075S6 ATV 312HU11M2, HU15M2 ATV 312HU11M3, HU15M3 ATV 312HU11N4, HU15N4 ATV 312HU15S6 ATV 312HU22M2 ATV 312HU22M3...HD15M3 ATV 312HU22N4...HD15N4 ATV 312HU22S6...HD15S6	150% of nominal motor torque (typical value) 100% of nominal motor torque (typical value) 50% of nominal motor torque (typical value) 30% of nominal motor torque (typical value)															
Maximum transient current			150% of the nominal drive current for 60 seconds (typical value)															
Motor control profiles			<ul style="list-style-type: none"> ■ Standard ratio (voltage/frequency) ■ Performance ratio (sensorless flux vector control) ■ Pump/fan ratio (Kn² quadratic ratio) ■ Energy saving ratio (specifically for ventilation) 															
Frequency loop gains			Factory-set with speed loop stability and gain Possible options for machines with high resistive torque or high inertia, or for machines with fast cycles															
Slip compensation			Automatic whatever the load. Can be inhibited or adjusted															
Electrical power characteristics																		
Power supply	Voltage	V	200 - 15% ... 240 + 10% single-phase for ATV 312●●●●M2 200 - 15% ... 240 + 10% three-phase for ATV 312●●●●M3 380 - 15% ... 500 + 10% three-phase for ATV 312●●●●N4 525 - 15% ... 600 + 10% three-phase for ATV 312●●●●S6															
	Frequency	Hz	50...60 + 5%															
Prospective short-circuit current I _{sc}	ATV 312●●●●M2	A	≤ 1000 (I _{sc} at the connection point) for single-phase power supply															
	ATV 312H018M3...HU40M3 ATV 312H037N4...HU40N4 ATV 312H075S6...HU40S6	A	≤ 5000 (I _{sc} at the connection point) for three-phase power supply															
	ATV 312HU55M3...HD15M3 ATV 312HU55N4...HD15N4 ATV 312HU55S6...HD15S6	A	≤ 22000 (I _{sc} at the connection point) for three-phase power supply															
Drive supply voltage and output voltage			<table border="1" style="width: 100%; border-collapse: collapse;"> <thead> <tr> <th></th> <th>Drive supply voltage</th> <th>Drive output voltage for motor</th> </tr> </thead> <tbody> <tr> <td>ATV 312H●●●M2</td> <td>V 200...240 single-phase</td> <td>200...240 three-phase</td> </tr> <tr> <td>ATV 312H●●●M3</td> <td>V 200...240 three-phase</td> <td>200...240 three-phase</td> </tr> <tr> <td>ATV 312H●●●N4</td> <td>V 380...500 three-phase</td> <td>380...500 three-phase</td> </tr> <tr> <td>ATV 312H●●●S6</td> <td>V 525...600 three-phase</td> <td>525...600 three-phase</td> </tr> </tbody> </table>		Drive supply voltage	Drive output voltage for motor	ATV 312H●●●M2	V 200...240 single-phase	200...240 three-phase	ATV 312H●●●M3	V 200...240 three-phase	200...240 three-phase	ATV 312H●●●N4	V 380...500 three-phase	380...500 three-phase	ATV 312H●●●S6	V 525...600 three-phase	525...600 three-phase
	Drive supply voltage	Drive output voltage for motor																
ATV 312H●●●M2	V 200...240 single-phase	200...240 three-phase																
ATV 312H●●●M3	V 200...240 three-phase	200...240 three-phase																
ATV 312H●●●N4	V 380...500 three-phase	380...500 three-phase																
ATV 312H●●●S6	V 525...600 three-phase	525...600 three-phase																
Connection characteristics (drive terminals for line supply, motor output, DC bus and braking resistor)																		
Drive terminals			L1, L2, L3, U, V, W, PC/–, PA/+, PB															
Maximum wire size and tightening torque	ATV 312H018M2...H075M2 ATV 312H018M3...HU15M3		2.5 mm ² (AWG 14) 0.8 Nm															
	ATV 312HU11M2...HU22M2 ATV 312HU22M3...HU40M3 ATV 312H037N4...HU40N4 ATV 312H075S6...HU40S6		5 mm ² (AWG 10) 1.2 Nm															
	ATV 312HU55M3, HU75M3 ATV 312HU55N4, HU75N4 ATV 312HU55S6, HU75S6		16 mm ² (AWG 6) 2.5 Nm															
	ATV 312HD11M3, HD15M3 ATV 312HD11N4, HD15N4 ATV 312HD11S6, HD15S6		25 mm ² (AWG 3) 4.5 Nm															
Electrical isolation			Electrical isolation between power and control (inputs, outputs, power supplies)															

Electrical control characteristics		
Available internal supplies		Protected against short-circuits and overloads: <ul style="list-style-type: none"> ■ One 10 V $\overline{\text{---}}$ (0/+ 8%) supply for the reference potentiometer (2.2 to 10 kΩ), maximum current 10 mA ■ One 24 V $\overline{\text{---}}$ supply (min. 19 V, max. 30 V) for the control logic inputs, maximum current 100 mA
Analog inputs		Sampling time < 8 ms Resolution: 10 bits Accuracy: \pm 4.3% Linearity: \pm 0.2% of the maximum scale value Use: <ul style="list-style-type: none"> ■ 100 m maximum with shielded cable ■ 25 m maximum with unshielded cable
	AI1	One 0...10 V $\overline{\text{---}}$ analog voltage input, impedance 30 k Ω , maximum safe voltage 30 V
	AI2	One \pm 10 V bipolar voltage analog input, impedance 30 k Ω , maximum safe voltage 30 V
	AI3	One X-Y mA analog current input, X and Y programmable from 0 to 20 mA, with impedance 250 Ω
Analog voltage outputs or analog current outputs configurable as logic outputs		2 analog outputs: <ul style="list-style-type: none"> ■ 1 analog voltage output (AOV) ■ 1 analog current output (AOC) configurable as a logic output. These 2 analog outputs cannot be used at the same time
	AOV	0...10 V $\overline{\text{---}}$ analog voltage output, min. load impedance 470 Ω 8-bit resolution, accuracy \pm 1%, linearity \pm 0.2% of the maximum scale value
	AOC	0...20 mA analog current output, max. load impedance 800 Ω 8-bit resolution, accuracy \pm 1%, linearity \pm 0.2% The AOC analog output can be configured as a 24 V logic output, max. 20 mA, min. load impedance 1.2 k Ω Refresh time < 8 ms
Relay outputs	R1A, R1B, R1C	1 relay logic output, one N/C contact and one N/O contact with common point Minimum switching capacity: 10 mA for 5 V $\overline{\text{---}}$ Maximum switching capacity: <ul style="list-style-type: none"> ■ On resistive load ($\cos \varphi = 1$ and L/R = 0 ms): 5 A for 250 V \sim or 30 V $\overline{\text{---}}$ ■ On inductive load ($\cos \varphi = 0.4$ and L/R = 7 ms): 2 A for 250 V \sim or 30 V $\overline{\text{---}}$ Sampling time < 8 ms Switching: 100,000 operations
	R2A, R2B	1 relay logic output, one N/C contact, contact open on fault. Minimum switching capacity: 10 mA for 5 V $\overline{\text{---}}$ Maximum switching capacity: <ul style="list-style-type: none"> ■ On resistive load ($\cos \varphi = 1$ and L/R = 0 ms): 5 A for 250 V \sim or 30 V $\overline{\text{---}}$ ■ On inductive load ($\cos \varphi = 0.4$ and L/R = 7 ms): 2 A for 250 V \sim or 30 V $\overline{\text{---}}$ Sampling time < 8 ms Switching: 100,000 operations
LI logic inputs	LI1...LI6	6 programmable logic inputs, compatible with PLC level 1, standard IEC/EN 61131-2 Impedance 3.5 k Ω 24 V $\overline{\text{---}}$ internal or 24 V $\overline{\text{---}}$ external power supply (min. 19 V, max. 30 V) Max. current: 100 mA Sampling time < 4 ms Multiple assignment makes it possible to configure several functions on one input (example: LI1 assigned to forward and preset speed 2, LI3 assigned to reverse and preset speed 3)
	Positive logic (Source)	State 0 if < 5 V or logic input not wired State 1 if > 11 V
	Negative logic (Sink)	State 0 if > 19 V or logic input not wired State 1 if < 13 V
	CLI position	Connection to PLC output (see diagram on page 54)
Maximum I/O wire size and tightening torque		2.5 mm ² (AWG 14) 0.6 Nm

Electrical control characteristics (continued)			
Acceleration and deceleration ramps			Ramp profiles: ■ Linear, can be adjusted separately from 0.1 to 999.9 s ■ S, U or customized Automatic adaptation of deceleration ramp time if braking capacities exceeded, possible inhibition of this adaptation (use of a braking resistor)
Braking to a standstill			By DC injection: ■ By a command on a logic input (LI1 to LI6) ■ Automatically as soon as the estimated output frequency drops to < 0.5 Hz, period adjustable from 0 to 30 s or continuous, current adjustable from 0 to 1.2 In
Main drive protection and safety features			Thermal protection against overheating Protection against short-circuits between motor phases Input phase loss protection, for three-phase supply Protection against motor phase breaks Overcurrent protection between motor output phases and earth Line supply overvoltage and undervoltage safety features
Motor protection (see page 73)			Thermal protection integrated in the drive by continuous calculation of the I ² t
Dielectric strength	Between earth and power terminals	ATV 312H●●●M2	2040 V ---
		ATV 312H●●●M3	
		ATV 312H●●●N4	
	Between control and power terminals	ATV 312H●●●M2	2410 V ---
		ATV 312H●●●M3	
		ATV 312H●●●N4	
	ATV 312H●●●S6	2550 V ---	
	ATV 312H●●●M2	2880 V ~	
	ATV 312H●●●M3	3400 V ~	
	ATV 312H●●●N4	3600 V ~	
	ATV 312H●●●S6		
Signalling			Display coded by one 4-digit display (messages, values) and 5 status LEDs (current mode, CANopen bus)
Frequency resolution	Display units	Hz	0.1
	Analog inputs	Hz	Resolution = ((high speed - low speed)/1024) Min. value = 0.1
Time constant on a change of reference		ms	5

Communication port characteristics

Available protocols		Modbus and CANopen protocols integrated in the drive. Both these protocols can be accessed via a single RJ45 connector on the underside of the drive.
Modbus protocol		
Structure	Connector	RJ45
	Physical interface	RS 485
	Transmission mode	RTU
	Transmission speed	Configurable via the Human-Machine interface, remote display terminals or SoMove setup software: 4800, 9600 or 19200 bps
	Number of subscribers	31
Services	Address	1 to 247, configurable via the Human-Machine interface, remote display terminals or SoMove setup software
	Functional profiles	CiA 402
	Messaging	Read Holding Registers (03) Write Single Register (06) Write Multiple Registers (16) Read Device Identification (43)
	Communication monitoring	Configurable
CANopen protocol		
Structure	Connector	RJ45
	Network management	Slave
	Transmission speed	Configurable via the Human-Machine interface, remote display terminals or SoMove setup software: 10, 20, 50, 125, 250, 500 kbps or 1 Mbps
	Number of subscribers	127
	Address (Node ID)	1 to 127, configurable via the Human-Machine interface, remote display terminals or SoMove setup software
Services	Number of PDOs (Process Data Objects)	2 PDOs: ■ PDO 1: cannot be configured ■ PDO 6: can be configured
	PDO modes	PDO 1: asynchronous PDO 6: asynchronous, Sync, cyclic asynchronous
	Number of SDOs (Service Data Objects)	1 receive SDO and 1 transmit SDO
	Functional profiles	CiA 402
	Communication monitoring	Node guarding and Heartbeat, Boot-up messages, Emergency messages, Sync and NMT
Diagnostics	Using LEDs	On Human-Machine interface
Description file		An eds file is available on our website www.schneider-electric.com or the "Description of the Motion & Drives offer" DVD-ROM

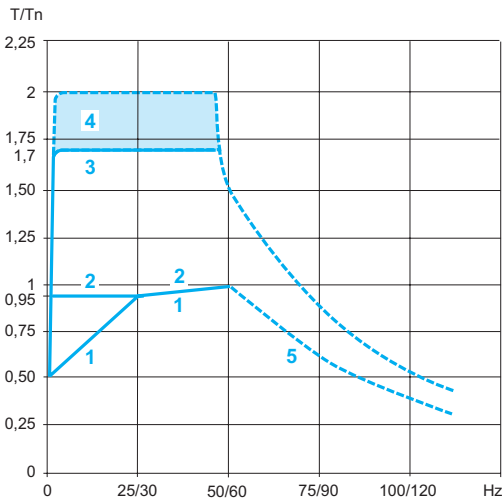

Torque characteristics (typical curves)

The curves opposite define the available continuous torque and transient overtorque for both force-cooled and self-cooled motors. The only difference is in the ability of the motor to provide a high continuous torque at less than half the nominal speed.

- 1 Self-cooled motor: continuous useful torque (1)
- 2 Force-cooled motor: continuous useful torque
- 3 Transient overtorque for 60 s
- 4 Transient overtorque for 2 s
- 5 Torque in overspeed at constant power (2)

Special uses

Use with a motor with a different power rating to that of the drive

The device can power any motor which has a lower rating than that for which the drive was designed. For motor ratings slightly higher than that of the drive, check that the current taken does not exceed the continuous output current of the drive.

Testing on a low power motor or without a motor

In a testing or maintenance environment the drive can be checked without having to switch to a motor with the same rating as the drive (particularly useful in the case of high power drives). This use requires deactivation of motor phase loss detection.

Use of motors in parallel

The drive rating must be greater than or equal to the sum of the currents and powers of the motors to be controlled.

In this case, it is necessary to provide external thermal protection for each motor using probes or thermal overload relays.

If three or more motors are connected in parallel, it is advisable to install a motor choke between the drive and the motors.

See page 46.

Motor switching at the drive output

Switching can be carried out with the drive locked or unlocked. In the case of switching on-the-fly (drive unlocked), the motor is controlled and accelerated until it reaches the reference speed smoothly following the acceleration ramp.

This use requires configuration of automatic catching a spinning load ("catch on the fly") and activation of the function which manages the presence of an output contactor.

Note: Depending on the drive rating, downstream ferrite suppressors may be required between the drive and the output contactor (see page 46).

Typical applications: loss of safety circuit at drive output, bypass function, switching of motors connected in parallel.

Recommendations for use: synchronize control of the output contactor with that of a freewheel stop request from the drive on a logic input.

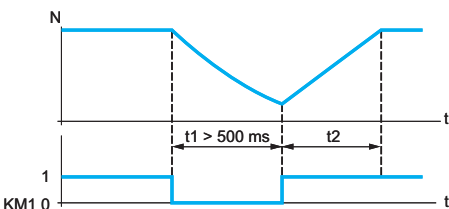
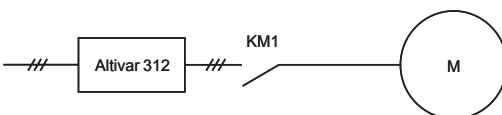

KM1: contactor

t1: KM1 opening time (motor freewheeling)

t2: acceleration with ramp

N: speed

Example of loss of output contactor

(1) For power ratings ≤ 250 W, less derating is required (20% instead of 50% at very low frequencies).

(2) The nominal motor frequency and the maximum output frequency can be adjusted from 40 to 500 Hz. The mechanical overspeed characteristics of the selected motor must be checked with the manufacturer.



ATV 312H075M2



ATV 312HU15N4



ATV 312HU30N4



ATV 312HU75N4

Drives (frequency range from 0.5 to 500 Hz)

Motor		Line supply				Altivar 312			Reference	Weight	
Power indicated on rating plate (1)	kW	HP	Max. line current (2), (3)		Apparent power	Max. prospective line Isc (4)	Max. continuous output current (In) (1)	Max. transient current for 60 s	Power dissipated at maximum output current (In) (1)	Reference	kg
			at U1	at U2							
			A	A	kVA	kA	A	A	W		
Single-phase supply voltage: 200...240 V 50/60 Hz, with integrated EMC filter (3) (5) (6)											
0.18	0.25	3.0	2.5	0.6	1	1.5	2.3	24	ATV 312H018M2	1.500	
0.37	0.5	5.3	4.4	1	1	3.3	5	41	ATV 312H037M2	1.500	
0.55	0.75	6.8	5.8	1.4	1	3.7	5.6	46	ATV 312H055M2	1.500	
0.75	1	8.9	7.5	1.8	1	4.8	7.2	60	ATV 312H075M2	1.500	
1.1	1.5	12.1	10.2	2.4	1	6.9	10.4	74	ATV 312HU11M2	1.800	
1.5	2	15.8	13.3	3.2	1	8	12	90	ATV 312HU15M2	1.800	
2.2	3	21.9	18.4	4.4	1	11	16.5	123	ATV 312HU22M2	3.100	
Three-phase supply voltage: 200...240 V 50/60 Hz, without EMC filter (3) (7)											
0.18	0.25	2.1	1.9	0.7	5	1.5	2.3	23	ATV 312H018M3	1.300	
0.37	0.5	3.8	3.3	1.3	5	3.3	5	38	ATV 312H037M3	1.300	
0.55	0.75	4.9	4.2	1.7	5	3.7	5.6	43	ATV 312H055M3	1.300	
0.75	1	6.4	5.6	2.2	5	4.8	7.2	55	ATV 312H075M3	1.300	
1.1	1.5	8.5	7.4	3	5	6.9	10.4	71	ATV 312HU11M3	1.700	
1.5	2	11.1	9.6	3.8	5	8	12	86	ATV 312HU15M3	1.700	
2.2	3	14.9	13	5.2	5	11	16.5	114	ATV 312HU22M3	1.700	
3	–	19.1	16.6	6.6	5	13.7	20.6	146	ATV 312HU30M3	2.900	
4	5	24.2	21.1	8.4	5	17.5	26.3	180	ATV 312HU40M3	2.900	
5.5	7.5	36.8	32	12.8	22	27.5	41.3	292	ATV 312HU55M3	6.400	
7.5	10	46.8	40.9	16.2	22	33	49.5	388	ATV 312HU75M3	6.400	
11	15	63.5	55.6	22	22	54	81	477	ATV 312HD11M3	10.500	
15	20	82.1	71.9	28.5	22	66	99	628	ATV 312HD15M3	10.500	
Three-phase supply voltage: 380...500 V 50/60 Hz, with integrated EMC filter (3) (5) (6)											
0.37	0.5	2.2	1.7	1.5	5	1.5	2.3	32	ATV 312H037N4	1.800	
0.55	0.75	2.8	2.2	1.8	5	1.9	2.9	37	ATV 312H055N4	1.800	
0.75	1	3.6	2.7	2.4	5	2.3	3.5	41	ATV 312H075N4	1.800	
1.1	1.5	4.9	3.7	3.2	5	3	4.5	48	ATV 312HU11N4	1.800	
1.5	2	6.4	4.8	4.2	5	4.1	6.2	61	ATV 312HU15N4	1.800	
2.2	3	8.9	6.7	5.9	5	5.5	8.3	79	ATV 312HU22N4	3.100	
3	–	10.9	8.3	7.1	5	7.1	10.7	125	ATV 312HU30N4	3.100	
4	5	13.9	10.6	9.2	5	9.5	14.3	150	ATV 312HU40N4	3.100	
5.5	7.5	21.9	16.5	15	22	14.3	21.5	232	ATV 312HU55N4	6.500	
7.5	10	27.7	21	18	22	17	25.5	269	ATV 312HU75N4	6.500	
11	15	37.2	28.4	25	22	27.7	41.6	397	ATV 312HD11N4	11.000	
15	20	48.2	36.8	32	22	33	49.5	492	ATV 312HD15N4	11.000	
Three-phase supply voltage: 525...600 V 50/60 Hz, without EMC filter (3) (8)											
0.75	1	2.8	2.4	2.5	5	1.7	2.6	36	ATV 312H075S6	1.700	
1.5	2	4.8	4.2	4.4	5	2.7	4.1	48	ATV 312HU15S6	1.700	
2.2	3	6.4	5.6	5.8	5	3.9	5.9	62	ATV 312HU22S6	2.900	
4	5	10.7	9.3	9.7	5	6.1	9.2	94	ATV 312HU40S6	2.900	
5.5	7.5	16.2	14.1	15	22	9	13.5	133	ATV 312HU55S6	6.200	
7.5	10	21.3	18.5	19	22	11	16.5	165	ATV 312HU75S6	6.200	
11	15	27.8	24.4	25	22	17	25.5	257	ATV 312HD11S6	10.000	
15	20	36.4	31.8	33	22	22	33	335	ATV 312HD15S6	10.000	

(1) These values are given for a nominal switching frequency of 4 kHz, for use in continuous operation.

The switching frequency is adjustable from 2 to 16 kHz. Above 4 kHz, derate the nominal drive current. The nominal motor current should not exceed this value. See derating curves on page 56.

(2) Typical value for a 4-pole motor and a maximum switching frequency of 4 kHz, with no line choke for max. prospective line Isc (4).

(3) Nominal supply voltage, min. U1, max. U2: 200 (U1)...240 V (U2), 380 (U1)...500 V (U2), 525 (U1)...600 V (U2).

(4) If line Isc is greater than the values in the table, add line chokes (see page 43).

(5) Drives supplied with category C2 or C3 integrated EMC filter. This filter can be disconnected.

(6) If a communication card is used, it takes the place of the control I/O card. To reduce installation costs, the drive can be ordered without a control I/O card. To do this, simply add a B at the end of the reference. For example: ATV 312H075N4 becomes ATV 312H075N4B. The communication card must be ordered separately (see page 28).

(7) EMC filter available as an option (see page 45).

(8) Mandatory line choke to be ordered separately (see page 43).

Variable speed drives

Altivar 312

Accessories, documentation, replacement parts



VW3 A9 804

Accessories				
Description	For drives	Sold in lots of	Reference	Weight kg
Plates for mounting on \perp rail, width 35 mm	ATV 312H018M2...H075M2	–	VW3 A9 804	0.290
	ATV 312H018M3...H075M3	–		
	ATV 312HU11M2, HU15M2	–	VW3 A9 805	0.385
	ATV 312HU11M3...HU22M3	–		
	ATV 312H037N4...HU15N4 ATV 312H075S6, HU15S6	–		
UL Type 1 conformity kits Mechanical device for fixing to the lower part of the drive. For direct connection of cables to the drive via tubes or cable glands	ATV 312H018M2...H075M2	–	VW3 A31812	0.400
	ATV 312H018M3...H075M3	–	VW3 A31811	0.400
	ATV 312HU11M3, HU15M3	–	VW3 A31813	0.400
	ATV 312HU11M2, HU15M2	–	VW3 A31814	0.500
	ATV 312HU22M3	–		
	ATV 312H037N4...HU15N4	–		
	ATV 312H075S6, HU15S6	–		
	ATV 312HU22M2	–	VW3 A31815	0.500
	ATV 312HU30M3, HU40M3	–		
	ATV 312HU22N4...HU40N4	–		
ATV 312HU22S6, HU40S6	–			
	ATV 312HU55M3, HU75M3	–	VW3 A31816	0.900
	ATV 312HU55N4, HU75N4	–		
	ATV 312HU55S6, HU75S6	–		
	ATV 312HD11M3, HD15M3	–	VW3 A31817	1.200
	ATV 312HD11N4, HD15N4	–		
	ATV 312HD11S6, HD15S6	–		
Shielding connection clamps Attachment and earthing of the cable shielding Pack of 25 clamps including: ■ 20 clamps for Ø 4.8 mm cable ■ 5 clamps for Ø 7.9 mm cable	ATV 312H●●●●●	25	TM200 RSRCEMC	–

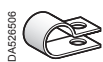

TM200 RSRCEMC

Documentation		
Description	Reference	Weight kg
"Description of the Motion & Drives offer" DVD-ROM Comprises (1): ■ Technical documentation (programming manuals, installation manuals, quick reference guides) ■ SoMove lite setup software ■ Catalogues ■ Brochures	VW3 A8 200	0.100

Replacement parts			
Description	For drives	Reference	Weight kg
ATV 312 control I/O card	ATV 312H●●●●●	VW3 A312 01	0.200
Fans	ATV 312HU11M2, HU15M2	VZ3 V3 101	0.200
	ATV 312HU11M3, HU22M3		
	ATV 312H037N4, HU15N4		
	ATV 312H075S6, HU15S6		
	ATV 312HU22M2	VZ3 V3 102	0.200
	ATV 312HU30M3, HU40M3		
	ATV 312HU22N4, HU40N4		
	ATV 312HU22S6, HU40S6		
	ATV 312HU55M3, HU75M3	VZ3 V3 103	0.200
	ATV 312HU55N4, HU75N4		
ATV 312HU55S6, HU75S6			
	ATV 312HD11M3, HD15M3	VZ3 V3 104	0.300
	ATV 312HD11N4, HD15N4		
	ATV 312HD11S6, HD15S6		



VZ3 V3 101

(1) The contents of this DVD-ROM are also available on our website www.schneider-electric.com.

Variable speed drives

Altivar 312

Communication buses and networks

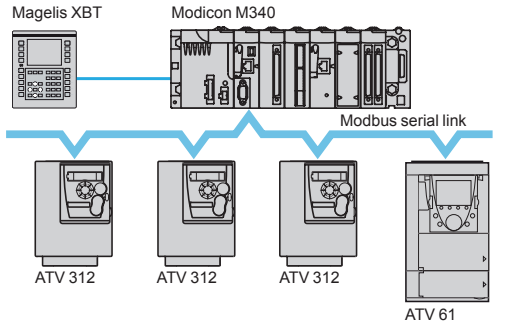

Example of configuration on Modbus serial link

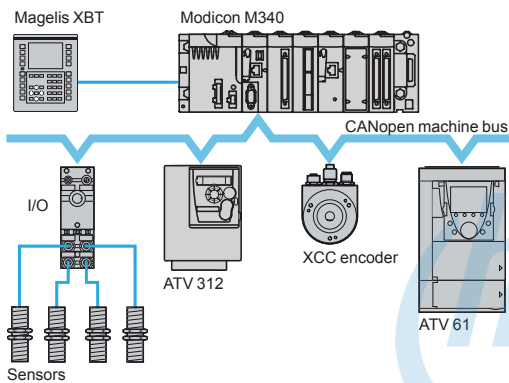

Example of configuration on CANopen machine bus

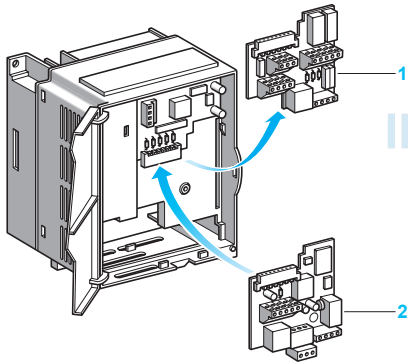

Example of installation of a communication card (1)

Presentation

The Altivar 312 drive is designed to meet the configuration requirements found in the main industrial communication installations.

It includes the Modbus and CANopen communication protocols as standard. It can also be connected to other industrial communication buses and networks using one of the communication cards or modules that are available as options.

Standard configuration

The Altivar 312 drive is equipped with a control I/O card **1** which integrates:

- I/O terminals, comprising:
 - Six logic inputs: LI1 to LI6
 - Three analog inputs: AI1 to AI3
 - Two analog outputs: AOV and AOC (2)
 - Two relay outputs: R1 and R2
- A Modbus/CANopen communication port, that is accessed on an RJ45 connector

The Modbus/CANopen communication port is specifically for controlling the drive via a PLC or another type of controller.

It is also used for connecting dialogue and configuration tools:

- Remote display terminal
- Remote graphic display terminal
- SoMove setup software
- SoMove Mobile software for mobile phones
- Simple Loader and Multi-Loader configuration tools

Communication cards for industrial applications

Several communication cards for industrial applications **2** are available as options. These cards are used in place of the drive's control I/O card **1** (1)

The following communication cards are available:

- CANopen Daisy chain card (optimized solution for daisy chain connection to CANopen machine bus, see page 32)
- DeviceNet card
- PROFIBUS DP card

Communication modules

The Altivar 312 drive can be connected to other communication buses and networks via modules that are available as options:

- Modbus TCP network via the Ethernet/Modbus bridge
- Fipio bus via the Fipio/Modbus gateway

(1) To reduce installation costs when replacing the control I/O card **1** with a communication card **2**, ATV 312H●●M2 and ATV 312H●●N4 drives can be ordered without a control I/O card. See page 26.

(2) These two outputs cannot be used at the same time.

Functions

All the functions of the Altivar 312 drive can be accessed via the communication buses and networks:

- Control
- Monitoring
- Adjustment
- Configuration

The speed control and reference may come from different control sources:

- Logic input or analog I/O terminals
- Communication bus or network
- Remote display terminal

The advanced functions of the Altivar 312 drive can be used to manage switching of these control sources according to the requirements of the application.

The assignment of the communication periodic I/O data can be selected using the network configuration software.

The Altivar 312 drive is controlled using the CiA 402 native profile.

Communication is monitored according to criteria specific to each protocol.

Regardless of protocol type, the reaction of the drive to a communication fault can be configured as follows:

- Freewheel stop, stop on ramp, fast stop or braked stop
- Maintain the last command received
- Fallback position at a predefined speed
- Ignore the fault

Characteristics of the CANopen Daisy chain card VW3 A312 08 (1)

Structure	Connector	4 connectors: <ul style="list-style-type: none"> ■ 1 removable screw terminal block: <ul style="list-style-type: none"> □ 3 logic inputs: L11 to L13 □ 2 analog inputs: AI2 and AI3 □ 1 relay output: R2 ■ 2 RJ45 connectors for daisy-chain connection to the CANopen machine bus ■ 1 RJ45 connector for connection to the Modbus serial link
------------------	-----------	---

(1) The other characteristics of the CANopen Daisy chain card are identical to those of the drive's CANopen protocol. See page 24.

Characteristics of the DeviceNet card VW3 A312 09

Structure	Connector	3 connectors: <ul style="list-style-type: none"> ■ 1 removable screw terminal block: <ul style="list-style-type: none"> □ 3 logic inputs: L11 to L13 □ 2 analog inputs: AI2 and AI3 □ 1 relay output: R2. ■ 1 five-way screw connector, 5.08 pitch, for connection to the DeviceNet network ■ 1 RJ45 connector for connection to the Modbus serial link
	Transmission speed	125 kbps, 250 kbps or 500 kbps, configurable using switches on the card
	Address	1 to 63, configurable using switches on the card
Services	Periodic variables	ODVA AC drive type profile 20, 21, 70 and 71 ATV 312 native profile (CiA 402) 100 and 101
	Exchange mode	Inputs: by polling, change of state, periodic Outputs: by polling
	Auto Device Replacement	No
	Communication monitoring	Can be inhibited Time out can be set via the DeviceNet network configurator
Diagnostics	Using LEDs	One two-tone LED on the card: "MNS" (status)
Description file		An eds file is available on our website www.schneider-electric.com or on the "Description of the Motion & Drives offer" DVD-ROM

Characteristics of the PROFIBUS DP card VW3 A312 07

Structure	Connector	3 connectors: <ul style="list-style-type: none"> ■ 1 removable screw terminal block: □ 3 logic inputs: LI1 to LI3 □ 2 analog inputs: AI2 and AI3 □ 1 relay output: R2. ■ 1 screw terminal block for connection to the PROFIBUS DP bus ■ 1 RJ45 connector for connection to the Modbus serial link
	Transmission speed	9600 bps, 19.2 kbps, 93.75 kbps, 187.5 kbps, 500 kbps, 1.5 Mbps, 3 Mbps, 6 Mbps or 12 Mbps
	Address	1 to 126, configurable using switches on the card
Services	Periodic variables	Input: 4 PKW and 2 PZD Output: 4 PKW and 2 PZD
	Messaging	Via PKW periodic variables
	Functional profile	IEC 61800-7 (CiA 402)
Diagnostics	Using LEDs	2 LEDs on the card: "ST" (status) and "DX" (data exchange)
Description file		A gsd file is available on our website www.schneider-electric.com or on the "Description of the Motion & Drives offer" DVD-ROM

Communication card references (1)

Designation	References	Weight kg
CANopen Daisy chain communication card for daisy chaining (see page 32)	VW3 A312 08	0.200
DeviceNet communication card	VW3 A312 09	0.200
PROFIBUS DP communication card	VW3 A312 07	0.200

(1) To reduce installation costs when replacing the control I/O card with a communication card, ATV 312H●●●M2 and ATV 312H●●●N4 drives can be ordered without a control I/O card. See page 26.

INDUSTRIAL AUTOMATION

Variable speed drives

Altivar 312

Communication buses and networks

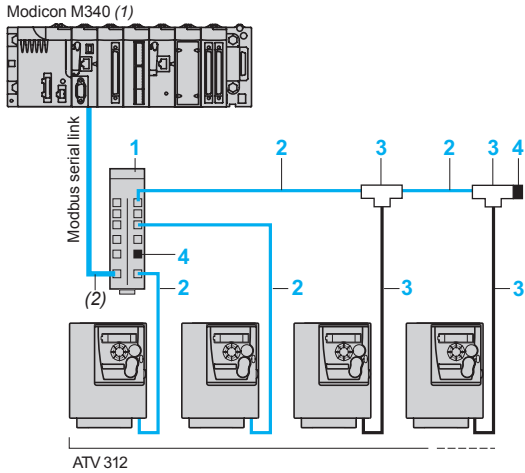

Example of Modbus serial link architecture, connections via splitter boxes and RJ45 connectors

Modbus serial link

Accessories for connection via splitter boxes and RJ45 connectors

Description	Item no.	Length m	Unit reference	Weight kg	
Modbus splitter box 10 RJ45 connectors and 1 screw terminal block	1	–	LU9 GC3	0.500	
Cables for Modbus serial link equipped with 2 RJ45 connectors	2	0.3	VW3 A8 306 R03	0.025	
	1	–	VW3 A8 306 R10	0.060	
	3	–	VW3 A8 306 R30	0.130	
Modbus T-connectors (with integrated cable)	3	0.3	VW3 A8 306 TF03	–	
	1	–	VW3 A8 306 TF10	–	
Modbus line terminators for RJ45 connector (3) (4)	R = 120 Ω	4	–	VW3 A8 306 RC	0.200
	C = 1 nf	4	–	VW3 A8 306 R	0.200

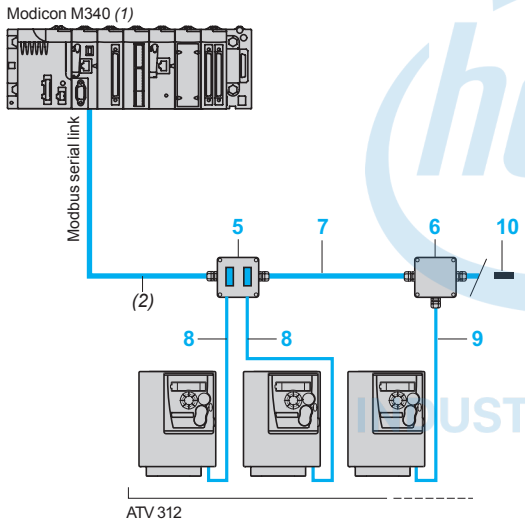

Example of Modbus serial link architecture, connections via tap junctions

Accessories for connection via tap junctions

Description	Item no.	Length m	Unit reference	Weight kg	
Modbus subscriber socket Two 15-way female SUB-D connectors and 2 screw terminal blocks, RC line terminator To be connected using cable VW3 A8 306	5	–	TSX SCA 62	0.570	
Modbus junction box 3 screw terminal blocks, RC line terminator To be connected using cable VW3 A8 306 D30	6	–	TSX SCA 50	0.520	
RS 485 double shielded twisted pair Modbus cables Supplied without connector	7	100	TSX CSA 100	–	
	200	–	TSX CSA 200	–	
	500	–	TSX CSA 500	–	
Modbus drop cable 1 RJ45 connector and 1 x 15-way male SUB-D connector for TSX SCA 62	8	3	VW3 A8 306	0.150	
Modbus drop cable 1 RJ45 connector and one stripped end	9	3	VW3 A8 306 D30	0.150	
Modbus line terminators for screw terminal block (3) (4)	R = 120 Ω	10	–	VW3 A8 306 DRC	0.200
	R = 150 Ω	10	–	VW3 A8 306 DR	0.200



TSX SCA 62



TSX SCA 50

(1) Please refer to the "M340 Automation platform" catalogue.

(2) Cable dependent on the type of controller or PLC.

(3) Depends on the bus architecture. Please refer to the "Soft starters and variable speed drives" catalogue.

(4) Sold in lots of 2.

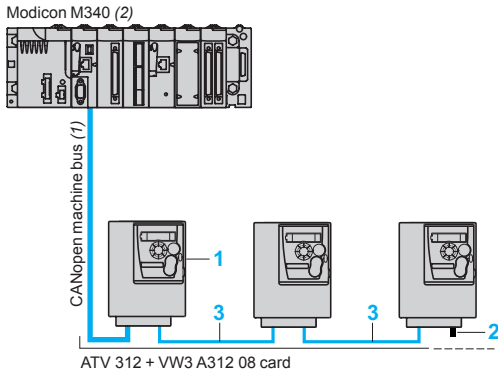

Optimized solution for daisy chain connection to the CANopen machine bus

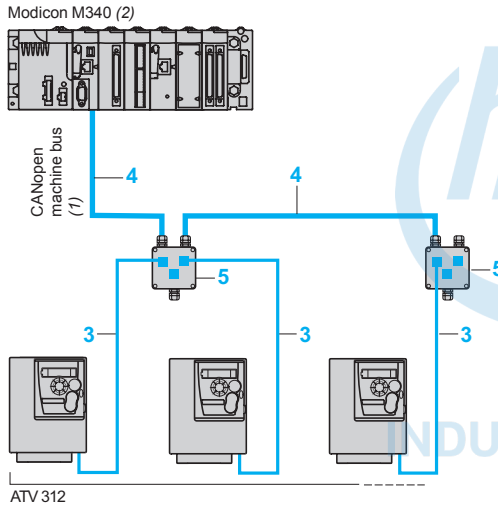

Conventional solution for connection to the CANopen machine bus



TCS CAR013M120

CANopen machine bus

Connection with CANopen Daisy chain communication card
(optimized solution for daisy chain connection to the CANopen machine bus)

Description	Item no.	Length m	Reference	Weight kg
CANopen Daisy chain communication card	1		VW3 A312 08	0.200
CANopen line terminator for RJ45 connector (4)	2	–	TCS CAR013M120	–
CANopen cables fitted with 2 RJ45 connectors	3	0.3	VW3 CAN CARR03	0.050
		1	VW3 CAN CARR1	0.500

Other connection accessories and cables (1)

Description	Item no.	Length m	Unit reference	Weight kg
CANopen cable Standard cable, C€ marking Low smoke emission, halogen-free Flame retardant (IEC 60332-1)	4	50	TSX CAN CA50	4.930
		100	TSX CAN CA100	8.800
		300	TSX CAN CA300	24.560
CANopen cable Standard cable, UL certification, C€ marking Flame retardant (IEC 60332-2)	4	50	TSX CAN CB50	3.580
		100	TSX CAN CB100	7.840
		300	TSX CAN CB300	21.870
CANopen cable Cable for harsh environments (3) or mobile installations, C€ marking Low smoke emission, halogen-free Flame retardant (IEC 60332-1)	4	50	TSX CAN CD50	3.510
		100	TSX CAN CD100	7.770
		300	TSX CAN CD300	21.700

IP20 CANopen junction boxes equipped with: ■ 2 screw terminal blocks for trunk cable tap link ■ 2 RJ45 connectors for connecting drives ■ 1 RJ45 connector for connecting a PC	5	–	VW3 CAN TAP2	0.250
---	----------	---	---------------------	-------

Daisy chain tap equipped with: ■ 2 spring terminals for daisy chain connection of the CANopen bus ■ 1 cable equipped with an RJ45 connector for connecting the drive	–	0.6	TCS CTN026M16M	–
--	---	-----	-----------------------	---

Daisy chain tap equipped with: ■ 2 RJ45 connectors for daisy chain connection of the CANopen bus ■ 1 cable equipped with an RJ45 connector for connecting the drive	–	0.3	TCS CTN023F13M03	–
---	---	-----	-------------------------	---

CANopen line terminator for screw terminal connector (4)	–	–	TCS CAR01NM120	–
--	---	---	-----------------------	---

(1) For other connection accessories, please refer to the "Machine & installations with industrial communication" catalogue.

(2) Please refer to the "M340 Automation platform" catalogue.

(3) Standard environment:

- No particular environmental constraints
- Operating temperature between + 5°C and + 60°C
- Fixed installation

Harsh environment:

- Resistance to hydrocarbons, industrial oils, detergents, solder splashes
- Relative humidity up to 100%
- Saline atmosphere
- Operating temperature between - 10°C and + 70°C
- Significant temperature variations

(4) Sold in lots of 2.

Variable speed drives

Altivar 312

Communication buses and networks



TSX ETG 100



LUF P1

Other communication buses and networks

Description	Cables to be connected	Reference	Weight kg
Ethernet gateway/router (1) Modbus Class B10 For connection to the Modbus TCP network	VW3 A8 306 D30 (2)	TSX ETG 100	–
Fipio/Modbus gateway (3) For connection to the Fipio bus	VW3 A8 306 R●● (2)	LUF P1	0.240

(1) Please refer to the "Machine & installations with industrial communication" catalogue.

(2) See page 31.

(3) Please refer to the "TeSys U starter-controllers" catalogue.



INDUSTRIAL AUTOMATION



Remote display terminal with cover open



Remote display terminal with cover closed

Remote display terminal (1)

This terminal is used to locate the human-machine interface of the Altivar 312 drive remotely on the door of an enclosure with IP 54 or IP 65 protection.

It is used to:

- Control, adjust and configure the drive remotely
- Display the drive status and faults remotely

Its maximum operating temperature is 50°C.

Description

- 1 4-digit display
- 2 Navigation ▲, ▼ and selection ENT, ESC keys
- 3 Motor local control keys:
 - RUN: starts the motor
 - FWD/REV: reverses the direction of rotation of the motor
 - STOP/RESET: stops the motor/resets drive faults
- 4 Operating mode selection key MODE.
- 5 Cover for optional access to the motor local control keys.

References

Description	Degree of protection	Length m	Reference	Weight kg
Remote display terminals A remote cable must be provided, VW3 A1 104R●●	IP 54	–	VW3 A1 006	0.250
	IP 65	–	VW3 A1 007	0.275
Remote cables equipped with 2 RJ45 connectors		1	VW3 A1 104R10	0.050
		3	VW3 A1 104R30	0.150

Remote graphic display terminal (2)

This graphic display terminal, common to all the variable speed drive ranges, provides a user-friendly interface for configuration, debugging and maintenance. Its main functions are as follows:

- The graphic screen displays 8 lines of 24 characters of plain text
- The navigation button provides quick and easy access to the drop-down menus
- It is supplied with six languages installed as standard (Chinese, English, French, German, Italian and Spanish). The available languages can be modified using the Multi-Loader configuration tool (VW3 A8 121).

The maximum operating temperature of the terminal is 60°C and it has IP 54 protection.

Description

- 1 Graphic display:
 - 8 lines of 24 characters, 240 x 160 pixels, large digit display
- 2 Function keys (not operational on the Altivar 312)
- 3 **Navigation button:** rotate ±: goes to the next/previous line, increases/decreases the value - press: saves the current value (ENT).
ESC key: aborts a value, a parameter or a menu to return to the previous selection.
- 4 Motor local control keys:
 - RUN: starts the motor
 - STOP/RESET: stops the motor/resets drive faults
 - FWD/REV: reverses the motor direction of rotation
- 5 Remote graphic display terminal
- 6 Remote cable
- 7 Female/female RJ45 adaptor

References

Description	Item no.	Length m	Reference	Weight kg
Remote graphic display terminal A remote cable, VW3 A1 104R●●, and an RJ45 adaptor, VW3 A1 105, must be provided	5	–	VW3 A1 101	–
Remote cables equipped with 2 RJ45 connectors	6	1	VW3 A1 104R10	0.050
		3	VW3 A1 104R30	0.150
		5	VW3 A1 104R50	0.250
		10	VW3 A1 104R100	0.500
Female/female RJ45 adaptor	7	–	VW3 A1 105	0.010



Graphic display terminal + female/female RJ45 adaptor + remote cable

(1) If an Altivar 31 drive is replaced by an Altivar 312 drive, the remote display terminal VW3 A1 101 can be used. Please consult the quick reference guide for this terminal, which is available on our website www.schneider-electric.com.

(2) The software version of the graphic display terminal must be ≥ V1.1.IE19. It can be updated using the Multi-Loader configuration tool (VW3 A8 121). See page 35.



Configuration with SoMove Mobile software for mobile phones

SoMove setup software

SoMove setup software for PC is used to prepare drive configuration files. The PC can be connected to the drive:

- Directly, using the USB/RJ45 cable (TCSM CNAM 3M002P)
- Using a Bluetooth® wireless connection, via the Modbus Bluetooth® adaptor (VW3 A8 114)

See page 36.

SoMove Mobile software for mobile phones (1)

SoMove Mobile software can be used to edit drive configurations on a mobile phone. The configurations can be saved, imported from a PC, exported to a PC or a drive equipped with the Modbus-Bluetooth® adaptor (VW3 A8 114).

The SoMove Mobile software and drive configuration files can be downloaded from our website www.schneider-electric.com.

References

Description	Reference	Weight kg
SoMove Mobile software for mobile phones (1) Can be downloaded from our website www.schneider-electric.com .	-	-
Modbus-Bluetooth® adaptor Comprises: - 1 Bluetooth® adaptor (range 10 m, class 2) with RJ45 connector - 1 x 0.1 m cable with 2 x RJ45 connectors - (2)	VW3 A8 114	0.155

Simple Loader and Multi-Loader configuration tools

The Simple Loader tool enables one powered-up drive's configuration to be duplicated on another powered-up drive. It is connected to the drive's RJ45 communication port.

The Multi-Loader tool enables several configurations to be copied from a PC or a powered-up drive and loaded on another powered-up drive.

It is connected to:

- A PC via a USB port
- The drive's RJ45 communication port

References

Description	Reference	Weight kg
Simple Loader configuration tool Supplied with a connection cable equipped with 2 RJ45 connectors.	VW3 A8 120	-
Multi-Loader configuration tool Supplied with: - 1 cable equipped with 2 RJ45 connectors - 1 cable equipped with one type A USB connector and one mini B USB connector - 1 x 2 GB SD memory card - 1 x female/female RJ 45 adaptor - 4 AA/LR6 1.5 V batteries	VW3 A8 121	-

(1) SoMove Mobile software requires a mobile phone with minimum features, please consult our website www.schneider-electric.com

(2) It also includes other elements for connecting compatible Schneider Electric devices.



Configuration with Simple Loader configuration tool connected to the ATV 312



Configuration with Multi-Loader configuration tool connected to the ATV 312

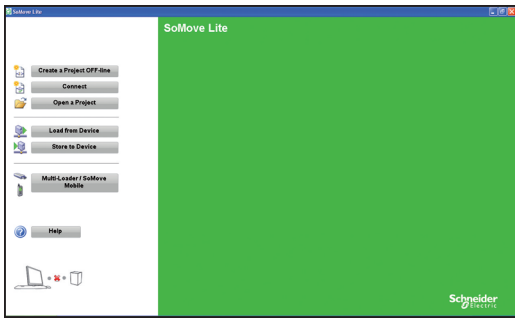

SoMove start page

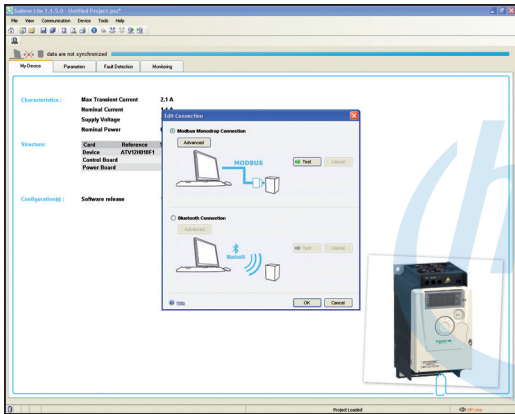

Example of connecting SoMove software to an ATV 12 drive

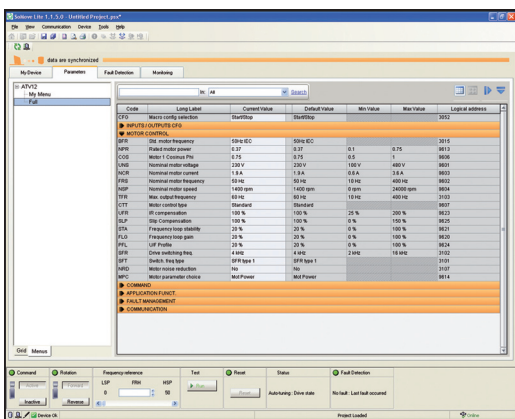

SoMove control panel

Presentation

SoMove is user-friendly setup software for PCs, for setting up the following Schneider Electric motor control devices:

- ATV 12, ATV 312, ATV 31, ATV 32, ATV 61 and ATV 71 variable speed drives
- ATS 22 starters
- TeSys U starter-controllers
- TeSys T motor management system
- Lexium 32 servo drives

SoMove software incorporates various functions for the device setup phases, such as:

- Configuration preparation
- Start-up
- Maintenance

To facilitate setup and maintenance, SoMove software can use a direct USB/RJ45 cable link or a Bluetooth® wireless link.

SoMove software is also compatible with the Multi-Loader configuration tool and SoMove Mobile software for mobile phones.

These tools can save a significant amount of time when loading, duplicating or editing configurations on a device.

SoMove software and all the DTMs (Device Type Managers) associated with the devices can be downloaded from our website www.schneider-electric.com.

Functions

Configuration preparation in disconnected mode

SoMove software has a genuine disconnected mode which provides access to all the device parameters. This mode can be used to generate the device configuration. The configuration can be saved, printed and exported to office automation software.

SoMove software also checks the consistency of the parameters, validating the configurations created in disconnected mode.

A large number of functions are available in disconnected mode, in particular:

- The device configuration software wizard
- The configuration comparison function
- Saving, copying, printing and creating configuration files for export to Multi-Loader, SoMove Mobile or Microsoft Excel® and sending configurations by e-mail.

Setup

When the PC is connected to the device, SoMove software can be used for:

- Transferring the configuration that has been generated onto the device
- Adjustment and monitoring. This includes such functions as:
 - The oscilloscope
 - Displaying communication parameters
- Easy control via the control panel user interface
- Saving the final configuration

Maintenance

In order to simplify maintenance operations, SoMove software can be used to:

- Compare the configuration of a device currently being used with a configuration saved on the PC
- Transfer a configuration to a device
- Compare oscilloscope curves
- Save oscilloscope curves and faults

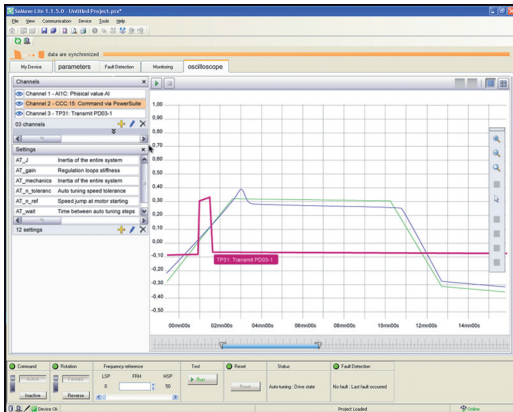

SoMove oscilloscope function

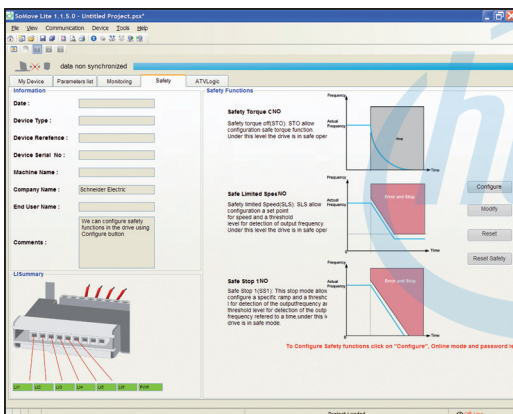

SoMove Safety function

Functions (continued)

User interface

SoMove software provides fast, direct access to all information on the device via five tabs:

- **My Device:** Displays all the information on the device (type, reference, software versions, option cards, etc.)
- **Parameters:** Displays all the device adjustment parameters, shown in a table or in the form of diagrams
- **Faults:** Displays a list of the faults that may be encountered with the device, the fault log and any current faults or alarms
- **Monitoring:** Provides a realtime display of the device status, its I/O and all the monitoring parameters. It is possible to create your own control panel by selecting your parameters and how they are to be represented.
- **Oscilloscope:** Provides a high-speed oscilloscope (recording traces in the device) or low-speed oscilloscope (recording traces in the software for devices that do not have an integrated oscilloscope)

SoMove's user interface automatically adapts to the specific configured device by offering additional tabs:

- **Safety:** For configuring the Safety functions on ATV 32 variable speed drives and Lexium 32 servo drives. It can also be used to:
 - Display the I/O
 - Compile and print a report
 - **ATVLogic:** For accessing the ATV 32 drive's programmable function blocks. It can also be used to:
 - Develop a program and transfer it to the drive
 - Display and debug the program already on the drive
 - **Auto-tuning:** For accessing the servo control settings for the three different operating modes of the Lexium 32 servo drive's auto-tuning function:
 - Automatic mode for quick setup, designed for simple applications
 - Semi-automatic mode for quick setup, with the option of optimizing the servo drive/servo motor combination (access to the mechanical and dynamic behaviour parameters)
 - Expert mode for optimizing the adjustment parameters, designed for complex applications

Connections

Modbus serial link

The PC running SoMove software can be connected directly via the RJ45 connector on the device and the USB port on the PC using the USB/RJ45 cable.

See the product references on page 38.

Bluetooth® wireless link

SoMove software can communicate via Bluetooth® wireless link with any Bluetooth® enabled device.

If the device is not Bluetooth® enabled, use the Modbus-Bluetooth® adaptor. This adaptor is connected to the terminal port or the Modbus network port on the device. It has a 10 m range (class 2).

If the PC is not Bluetooth® enabled, use the USB-Bluetooth® adaptor.

See the product references on page 38.



SoMove setup software

PF080632

VW3 A8 114:
Bluetooth® adaptor

References

Description	Reference	Weight kg
SoMove lite setup software Comprising: <ul style="list-style-type: none"> ■ SoMove setup software for PC in English, French, German, Italian, Spanish and Chinese ■ DTMs (Device Type Managers) and technical documentation for variable speed drives, starters and servo motors 	(1)	–
USB/RJ45 cable Used to connect a PC to the device. This cable is 2.5 m long, and has a USB connector (PC end) and an RJ45 connector (device end).	TCSM CNAM 3M002P	–
Modbus-Bluetooth® adaptor Used to enable any non-Bluetooth® device to communicate via Bluetooth® wireless link (2). Comprising: <ul style="list-style-type: none"> ■ 1 Bluetooth® adaptor (range 10 m, class 2) with an RJ45 connector ■ For SoMove: 1 x 0.1 m cable with 2 x RJ45 connectors ■ For TwidoSuite: 1 x 0.1 m cable with 1 RJ45 connector and 1 mini DIN connector 	VW3 A8 114	0.155
USB-Bluetooth® adaptor for PC Used to enable any non-Bluetooth® PC to communicate via Bluetooth® wireless link (3). It connects to a USB port on the PC. Range 10 m (class 2)	VW3 A8 115	0.290

(1) Available on our website "www.schneider-electric.com"

(2) Required for the following devices:

- ATV 12, ATV 312, ATV 31, ATV 61 and ATV 71 drives
- ATS 22 starters
- TeSys U starter-controllers
- TeSys T motor management system
- Lexium 32 servo drives

(3) Check the manufacturer's specification.

INDUSTRIAL AUTOMATION

Compatibility of SoMove software with specific devices

Device	Range	Version of software on the device
Variable speed drive	ATV 12, ATV 312, ATV 32	≥ 1.0
	ATV 31	≥ 1.1
	ATV 61, ATV 71	≥ 1.6
Starter	ATS 22	≥ 1.0
Starter-controller	TeSys U	≥ 1.0
Motor management system	TeSys T	≥ 1.0
Servo drive	Lexium 32	≥ 1.0

Environments

SoMove operates in the following PC environments and configurations:

- Microsoft Windows® 7 Professional (1)
- Microsoft Windows® XP Professional SP3
- Microsoft Windows® Vista Business SP2
- Pentium IV (or equivalent), 1 GHz, hard disk with 1 GB available space, 1 GB of RAM (minimum configuration)

(1) Please contact our Customer Care Centre.

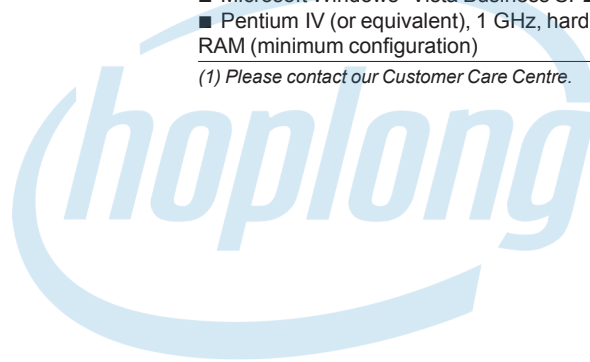

INDUSTRIAL AUTOMATION

Presentation

The resistor enables the Altivar 312 drive to operate while braking to a standstill or during slowdown braking, by dissipating the braking energy.
 Two types of resistor are available:

- Enclosed model (IP 20 casing) designed to comply with the EMC standard and protected by a temperature-controlled switch or thermal overload relay. This model enables maximum transient braking torque. The resistors are designed to be mounted on the outside of the enclosure, but should not inhibit natural cooling. Air inlets and outlets must not be obstructed in any way. The air must be free of dust, corrosive gas and condensation.
- Non-protected model (IP 00) for lower power ratings only.

Applications

Machines with high inertia, driving loads and machines with fast cycles.

General characteristics

Type of braking resistor			VW3 A7 723 to VW3 A7 725	VW3 A7 701 to VW3 A7 705
Ambient air temperature around the device	Operation	°C	40	0...+ 50
	Storage	°C	- 25...+ 70	
Degree of protection of the casing			IP 00	IP 20
Thermal protection			None	Via temperature-controlled switch or via the drive
Temperature controlled switch (1)	Tripping temperature	°C	–	120
	Max. voltage - max. current		–	250 V ~ - 1 A
	Min. voltage - min. current		–	24 V ~ - 0.1 A
	Maximum switch resistance	mΩ	–	60
Operating factor for the dynamic brake transistors			The average power that can be dissipated at 40°C from the resistor into the casing is determined for a load factor during braking that corresponds to most common applications. The dynamic brake transistor is sized so that it can tolerate: - The nominal motor power continuously - 150% of the nominal motor power for 60 s	

(1) The switch must be connected in the sequence (use for signalling or in line contactor control).

Load factor and determining the nominal power

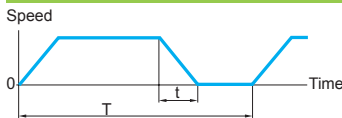

Load factor: $\frac{t}{T}$
 t: braking time in s
 T: cycle time in s

Chart 1

Graph of the average power as a function of the braking torque for a load factor

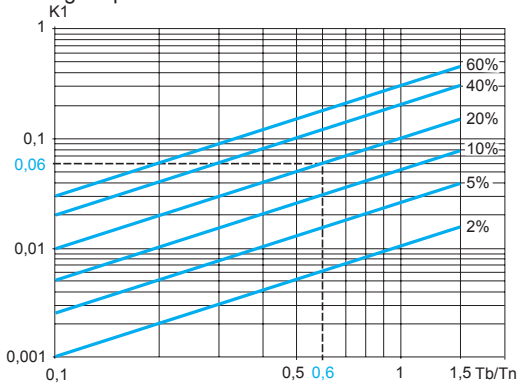

Example:
 Motor power Pm = 4 kW
 Motor efficiency h = 0.85
 Braking torque Tb = 0.6 Tn
 Braking time t = 10 s
 Cycle time T = 50 s
 Load factor fm = $\frac{t}{T}$ = 20%

Use chart 1 to determine coefficient K1 corresponding to a braking torque of 0.6 Tn and a load factor of 20%:
K1 = 0.06

The average power that can be dissipated at 40°C from the resistor into the casing is determined for a load factor during braking that corresponds to most common applications. This load factor is defined in the table above.
 For a specific application (example: handling), the nominal power of the resistor must be redefined incorporating the new load factor.

Chart 2

Permissible resistor overload as a function of time (characteristic curve)

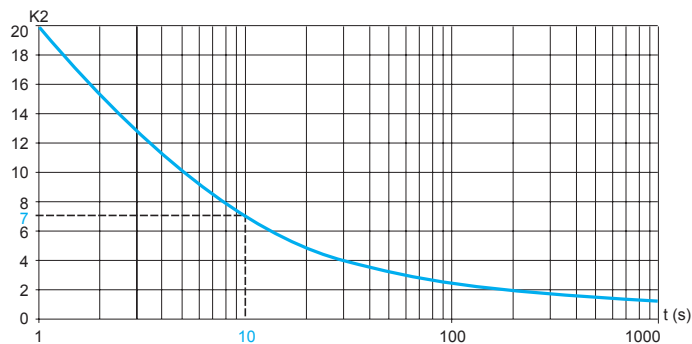

Use chart 2 to determine coefficient K2 corresponding to a braking time of 10 seconds.
K2 = 7

The nominal power of the resistor (Pn) must be greater than:

$$P_n = P_m \times K_1 \times \eta \left(1 + \frac{1}{K_2 \times f_m}\right) = 4.10^3 \times 0.06 \times 0.8 \left(1 + \frac{1}{7 \times 0.2}\right) = 350 \text{ W}$$

Variable speed drives

Altivar 312

Option: braking resistors



VW3 A7 723

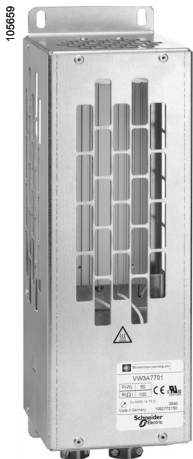

VW3 A7 701

For drives	Minimum resistor value (1) Ω	Ohmic value Ω	Average power available at		Reference	Weight kg
			40°C (2) W	50°C W		
Non-protected braking resistors						
ATV 312H018M2...H075M2	40	100	32	28	VW3 A7 723	0.600
ATV 312HU11M2, HU15M2	27					
ATV 312H018M3...H075M3	40					
ATV 312HU11M3, HU15M3	27					
ATV 312H037N4...H075N4	80					
ATV 312HU11N4...HU22N4	54					
ATV 312H075S6	96					
ATV 312HU15S6, HU22S6	64					
ATV 312HU30N4	55	100	40	35	VW3 A7 725	0.850
ATV 312HU40N4	36					
ATV 312HU40S6	44					
ATV 312HU22M2, ATV 312HU22M3	25	68	32	28	VW3 A7 724	0.600
ATV 312HU30M3	16					
Protected braking resistors						
ATV 312H018M2...H075M2	40	100	58	50	VW3 A7 701	2.000
ATV 312HU11M2, HU15M2	27					
ATV 312H018M3...H075M3	40					
ATV 312HU11M3, HU15M3	27					
ATV 312H037N4...H075N4	80					
ATV 312HU11N4...HU22N4	54					
ATV 312HU22M2, ATV 312HU22M3	25	60	115	100	VW3 A7 702	2.400
ATV 312HU30M3	16					
ATV 312HU30N4	55	100	58	50	VW3 A7 701	2.000
ATV 312HU40N4	36					
ATV 312HU55N4	29	60	115	100	VW3 A7 702	2.400
ATV 312HU75N4	19					
ATV 312HU55S6	34					
ATV 312HU75S6	23					
ATV 312HU40M3	16	28	231	200	VW3 A7 703	3.500
ATV 312HD11N4, HD15N4	20					
ATV 312HD11S6, HD15S6	24					
ATV 312HU55M3, HU75M3	8	15	1154	1000	VW3 A7 704	11.000
ATV 312HD11M3, HD15M3	5	10 (3)	1154	1000	VW3 A7 705	11.000

(1) Depends on the drive rating.

(2) Power that can be dissipated by the resistor at the maximum temperature of 115°C, corresponding to a maximum temperature rise of 75°C in a 40°C environment.

(3) Ohmic value obtained as a function of the connection described in the resistor operating instructions.

Presentation

Line chokes provide improved protection against overvoltages on the line supply and reduce harmonic distortion of the current produced by the drive.

The recommended chokes limit the line current. They have been developed in line with standard IEC 61800-5-1 (VDE 0160 level 1 high-energy overvoltages on the line supply).

The inductance values are defined for a voltage drop between 3% and 5% of the nominal line voltage. Values higher than this will cause loss of torque.

The use of line chokes is recommended in particular for ATV 312H●●●M2, ATV 312H●●●M3 and ATV 312H●●●N4 drives under the following circumstances:

- Line supply with significant disturbance from other equipment (interference, overvoltages)
- Line supply with voltage imbalance between phases > 1.8% of nominal voltage
- Drive supplied by a line with very low impedance (in the vicinity of a power transformer 10 times more powerful than the drive rating)
- Installation of a large number of frequency inverters on the same line
- Reduction of overloads on the cos φ correction capacitors, if the installation includes a power factor correction unit

The use of line chokes is mandatory for ATV 312H●●●S6 drives.

The prospective short-circuit current at the drive connection point must not exceed the maximum value indicated in the reference tables. The use of chokes allows connection to the following line supplies:

- Max. Isc 22 kA for 200/240 V
- Max. Isc 65 kA for 380/500 V and 525/600V

Characteristics

Type of line choke		VZ1 L004 M010	VZ1 L007 UM50	VZ1 L018 UM20	VW3 A4 551	VW3 A4 552	VW3 A4 553	VW3 A4 554	VW3 A4 555
Conformity to standards		IEC 61800-5-1 (VDE 0160 level 1 high-energy overvoltages on the line supply)							
Voltage drop		Between 3% and 5% of the nominal line voltage. Values higher than this will cause loss of torque.							
Degree of protection	Choke	IP 00							
	Terminals	IP 20						IP 10	
Inductance value	mH	10	5	2	10	4	2	1	0.5
Nominal current	A	4	7	18	4	10	16	30	60
Losses	W	17	20	30	45	65	75	90	80

Variable speed drives

Altivar 312

Option: line chokes

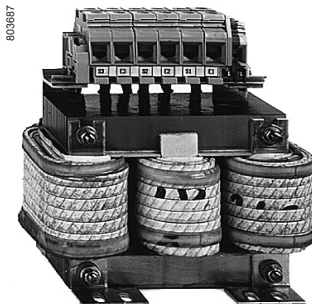

VW3A4 55

Line chokes						
Altivar 312					Choke	
	Line current without choke		Line current with choke		Reference	Weight
	U min. (1)	U max. (1)	U min. (1)	U max. (1)		
	A	A	A	A	kg	
Single-phase supply voltage: 200...240 V 50/60 Hz						
ATV 312H018M2	3.0	2.5	2.1	1.8	VZ1 L004M010	0.630
ATV 312H037M2	5.3	4.4	3.9	3.3		
ATV 312H055M2	6.8	5.8	5.2	4.3	VZ1 L007UM50	0.880
ATV 312H075M2	8.9	7.5	7.0	5.9		
ATV 312HU11M2	12.1	10.2	10.2	8.6	VZ1 L018UM20	1.990
ATV 312HU15M2	15.8	13.3	13.4	11.4		
ATV 312HU22M2	21.9	18.4	19.2	16.1		
Three-phase supply voltage: 200...240 V 50/60 Hz						
ATV 312H018M3	2.1	1.9	1	0.9	VW3 A4 551	1.500
ATV 312H037M3	3.8	3.3	1.9	1.6		
ATV 312H055M3	4.9	4.2	2.5	2.2		
ATV 312H075M3	6.4	5.6	3.3	2.9		
ATV 312HU11M3	8.5	7.4	4.8	4.2	VW3 A4 552	3.000
ATV 312HU15M3	11.1	9.6	6.4	5.6		
ATV 312HU22M3	14.9	13	9.2	8	VW3 A4 553	3.500
ATV 312HU30M3	19.1	16.6	12.3	10.7		
ATV 312HU40M3	24.2	21.1	16.1	14	VW3 A4 554	6.000
ATV 312HU55M3	36.8	32	21.7	19		
ATV 312HU75M3	46.8	40.9	29	25.2		
ATV 312HD11M3	63.5	55.6	41.6	36.5	VW3 A4 555	11.000
ATV 312HD15M3	82.1	71.9	55.7	48.6		
Three-phase supply voltage: 380...500 V 50/60 Hz						
ATV 312H037N4	2.2	1.7	1.1	0.9	VW3 A4 551	1.500
ATV 312H055N4	2.8	2.2	1.4	1.2		
ATV 312H075N4	3.6	2.7	1.8	1.5		
ATV 312HU11N4	4.9	3.7	2.6	2		
ATV 312HU15N4	6.4	4.8	3.4	2.6		
ATV 312HU22N4	8.9	6.7	5	4.1	VW3 A4 552	3.000
ATV 312HU30N4	10.9	8.3	6.5	5.2		
ATV 312HU40N4	13.9	10.6	8.5	6.6		
ATV 312HU55N4	21.9	16.5	11.7	9.3	VW3 A4 553	3.500
ATV 312HU75N4	27.7	21	15.4	12.1		
ATV 312HD11N4	37.2	28.4	22.5	18.1	VW3 A4 554	6.000
ATV 312HD15N4	48.2	36.8	29.6	23.3		
Three-phase supply voltage: 525...600 V 50/60 Hz						
ATV 312H075S6 (2)	-	-	1.4	1.4	VW3 A4 551	1.500
ATV 312HU15S6 (2)	-	-	2.4	2.3		
ATV 312HU22S6 (2)	-	-	3.8	3.6		
ATV 312HU40S6 (2)	-	-	6	5.8	VW3 A4 552	3.000
ATV 312HU55S6 (2)	-	-	7.8	7.5		
ATV 312HU75S6 (2)	-	-	11	10.7	VW3 A4 553	3.500
ATV 312HD11S6 (2)	-	-	15	14.4		
ATV 312HD15S6 (2)	-	-	21.1	20.6	VW3 A4 554	6.000

(1) Nominal supply voltage:

For drives	Nominal voltage	
	U min.	U max.
ATV 312H●●●M2 ATV 312H●●●M3	200	240
ATV 312H●●●N4 ATV 312H●●●S6	380	500
	525	600

(2) Line choke mandatory for ATV 312H●●●S6 drives.

Altivar 312

Integrated EMC filters and optional additional EMC filters

Presentation

Integrated filters

Altivar 312 drives, apart from ATV 312H●●●M3 and ATV312H●●●S6, have integrated radio interference input filters to comply with the EMC standard for variable speed electrical power drive "products" IEC 61800-3, categories C2 or C3, and to comply with the European EMC (electromagnetic compatibility) directive.

Additional EMC input filters

Additional EMC input filters (1) enable drives to meet more stringent requirements: they are designed to reduce conducted emissions on the line supply below the limits of standard IEC 61800-3 category C1 or C2 (see page 45).

These additional EMC filters can be mounted beside or under the drive. They act as a support for the drives and are attached to them via tapped holes.

Use according to the type of line supply

Additional EMC filters can only be used on TN (neutral connection) and TT (neutral to earth) type systems.

Standard IEC 61800-3, appendix D2.1, states that on IT systems (isolated or impedance earthed neutral), filters can cause permanent insulation monitors to operate in a random manner.

The effectiveness of additional filters on this type of system depends on the type of impedance between neutral and earth, and therefore cannot be predicted.

If a machine has to be installed on an IT system, one solution is to insert an isolation transformer and connect the machine locally on a TN or TT system.

Characteristics

Conformity to standards			EN 133200
Degree of protection			IP 21 and IP 41 on upper part
Maximum relative humidity			95% non-condensing, no dripping water conforming to IEC 60068-2-3
Ambient air temperature around the device	Operation	°C	- 10...+ 60
	Storage	°C	- 25...+ 70
Maximum operating altitude	Without derating	m	1000 (above this, derate the current by 1% for every additional 100 m)
Vibration resistance	Conforming to IEC 60068-2-6		1.5 mm peak to peak from 3 to 13 Hz 1 gn peak from 13 to 150 Hz
Shock resistance	Conforming to IEC 60068-2-27		15 gn for 11 ms
Maximum nominal voltage	50/60 Hz single-phase	V	240 + 10%
	50/60 Hz three-phase	V	240 + 10% 500 + 10%

(1) Not available for ATV 312H●●●S6 drives

Variable speed drives

Altivar 312

Option: additional EMC input filters

106586

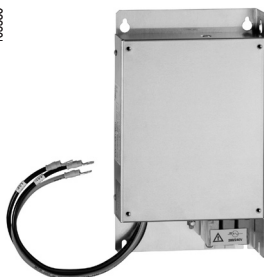

VW3 A31405

Additional EMC input filters

For drives	Filter						Weight
Reference	Maximum length of shielded cable (1)	In (2)	II (3)	Losses (4)	Reference	Weight	
	IEC 61800-3 (5)						
	Category C2	Category C1	A	mA	W	kg	
	m	m					
Single-phase supply voltage: 200...240 V 50/60 Hz							
ATV 312H018M2 ATV 312H037M2 ATV 312H055M2 ATV 312H075M2	50	20	9	100	3.7	VW3 A31401	0.600
ATV 312HU11M2 ATV 312HU15M2	50	20	16	150	6.9	VW3 A31403	0.775
ATV 312HU22M2	50	20	22	80	7.5	VW3 A31405	1.130
Three-phase supply voltage: 200...240 V 50/60 Hz							
ATV 312H018M3 ATV 312H037M3 ATV 312H055M3 ATV 312H075M3	5	–	7	7	2.6	VW3 A31402	0.650
ATV 312HU11M3 ATV 312HU15M3 ATV 312HU22M3	5	–	15	15	9.9	VW3 A31404	1.000
ATV 312HU30M3 ATV 312HU40M3	5	–	25	35	15.8	VW3 A31406	1.650
ATV 312HU55M3 ATV 312HU75M3	5	–	47	45	19.3	VW3 A31407	3.150
ATV 312HD11M3 ATV 312HD15M3	5	–	83	15	35.2	VW3 A31408	5.300
Three-phase supply voltage: 380...500 V 50/60 Hz							
ATV 312H037N4 ATV 312H055N4 ATV 312H075N4 ATV 312HU11N4 ATV 312HU15N4	50	20	15	15	9.9	VW3 A31404	1.000
ATV 312HU22N4 ATV 312HU30N4 ATV 312HU40N4	50	20	25	35	15.8	VW3 A31406	1.650
ATV 312HU55N4 ATV 312HU75N4	50	20	47	45	19.3	VW3 A31407	3.150
ATV 312HD11N4 ATV 312HD15N4	50	20	49	45	27.4	VW3 A31409	4.750

(1) The filter selection tables give the maximum lengths for shielded cables connecting motors to drives for a switching frequency of 2 to 16 kHz. These maximum lengths are given as examples only, as they vary depending on the stray capacitance of the motors and the cables used. If motors are connected in parallel, the sum of the cable lengths must be taken into account.

(2) In: nominal filter current.

(3) II: maximum earth leakage current at 50 Hz.

(4) Via heat dissipation, at the nominal filter current (In).

(5) Standard IEC 61800-3: EMC immunity and conducted and radiated EMC emissions:

- Category C1: public power supply (residential)

- Category C2: industrial power supply

Variable speed drives

Altivar 312

Options: output filters, motor chokes and ferrite suppressors

Presentation

Output filters and motor chokes can be inserted between the Altivar 312 drive and the motor to:

- Limit the dv/dt at the motor terminals (500 to 1500 V/μs), for cables longer than 50 m
- Filter interference caused by opening a contactor placed between the filter and the motor
- Reduce the motor earth leakage current

The output filter range comprises LR filter cells.

Ferrite suppressors are necessary on ATV 312H●●●M2 and ATV 312H018M3...HU22M3 drives when an output contactor is used.

LR filter cell

This cell comprises 3 high-frequency chokes and 3 resistors.

The LR filter cell is particularly suitable for:

- Reducing the dv/dt at the motor terminals
- Using long motor cables (see characteristics table page 47)

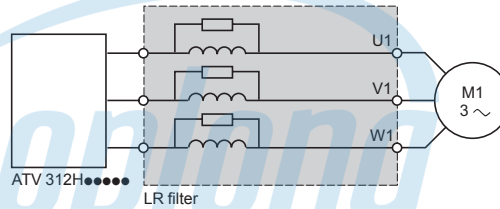

Motor choke

The motor choke is particularly suitable for:

- Reducing overvoltages at the motor terminals (see length of motor cable in characteristics table page 47)
- Minimizing the current wave, thus reducing motor noise

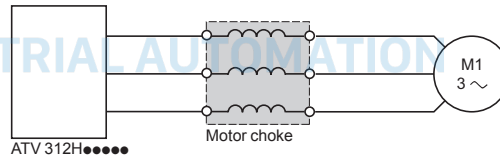

Ferrite suppressors for downstream contactor opening

Ferrite suppressors for downstream contactor opening are inserted on the motor cable between ATV 312H●●●M2 or ATV 312H018M3...HU22M3 drives and the output contactor.

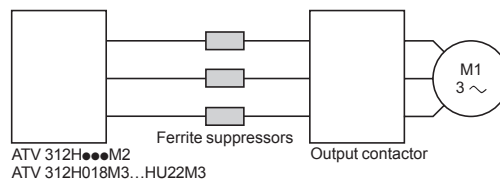

Characteristics (1)

		LR filter cells (2)	Motor chokes	
		VW3 A5845●	VW3 A4 552...A4 555	VW3 A4 556
Drive switching frequency	kHz	0.5...4	4	
Length of motor cable	Shielded cables	m	≤ 100	
	Unshielded cables	m	≤ 200	
Degree of protection		IP 20	IP 20	IP 00

References

LR filter cells					
Designation	For drives	Losses	Nominal current	Reference	Weight
		W	A		
LR filter cells	ATV 312H018M2...HU15M2 ATV 312H018M3...HU15M3 ATV 312H037N4...HU40N4 ATV 312H075S6...HU55S6	150	10	VW3 A58451	7.400
	ATV 312HU22M2 ATV 312HU22M3, HU30M3 ATV 312HU55N4 ATV 312HU75S6	180	16	VW3 A58452	7.400
	ATV 312HU40M3...HU75M3 ATV 312HU75N4...HD15N4 ATV 312HD11S6, HD15S6	220	33	VW3 A58453	12.500
Motor chokes					
Designation	For drives	Losses	Nominal current	Reference	Weight
		W	A		
Motor chokes	ATV 312HU22N4...HU40N4 ATV 312HU40S6, HU55S6	65	10	VW3 A4 552	3.000
	ATV 312HU22M2 ATV 312HU22M3, HU30M3 ATV 312HU55N4 ATV 312HU75S6	75	16	VW3 A4 553	3.500
	ATV 312HU40M3...HU75M3 ATV 312HU75N4, HD11N4 ATV 312HD11S6, HD15S6	90	30	VW3 A4 554	6.000
	ATV 312HD15N4	80	60	VW3 A4 555	11.000
	ATV 312HD11M3, HD15M3	–	100	VW3 A4 556	16.000
	Ferrite suppressors for downstream contactor opening				
Designation	For drives	Sold in lots of		Unit reference	Weight
					kg
Ferrite suppressors for downstream contactor opening	ATV 312H018M2	3		VW3 A31451	0.300
	ATV 312H037M2 ATV 312H018M3, H037M3	3		VW3 A31452	0.200
	ATV 312H055M2...HU22M2 ATV 312H055M3...HU22M3	3		VW3 A31453	0.100

(1) Filter performance is ensured if the cable lengths between the motor and the drive, given in the above table, are not exceeded. For an application with several motors connected in parallel, the cable length must include all cabling. If a cable longer than that recommended is used, the filters may overheat.

(2) For other LR filter configurations, please consult your Customer Care Centre.

Drives

ATV 312H018M2...H075M2, ATV 312H018M3...H075M3

EMC mounting plate (supplied with the drive)

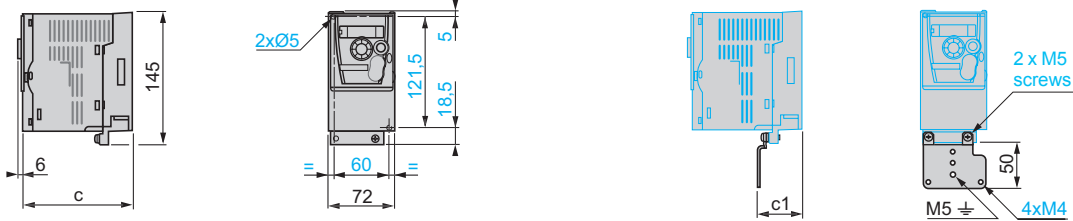

ATV 312	c	c1
H018M2, H037M2	132	61.5
H055M2, H075M2	142	61.5
H018M3, H037M3	122	51.5
H055M3, H075M3	132	51.5

ATV 312HU11M2...HU22M2, ATV 312HU11M3...HU40M3, ATV 312H037N4...HU40N4, ATV 312H075S6...HU40S6

EMC mounting plate (supplied with the drive)

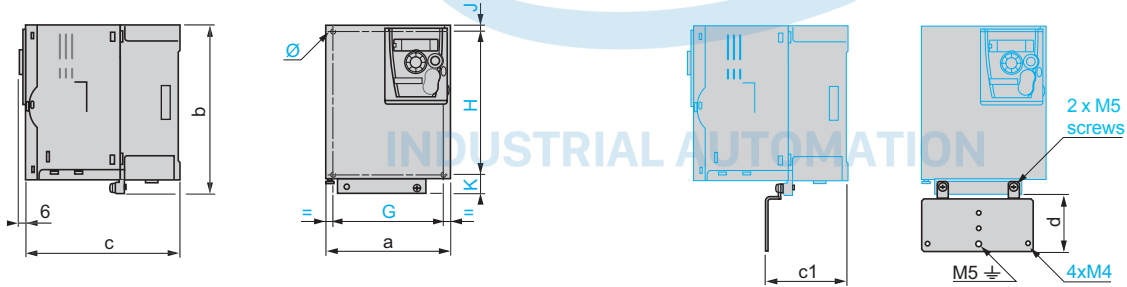

ATV 312	a	b	c	c1	d	G	H	J	K	Ø
HU11M3, HU15M3	105	143	132	67.3	49	93	121.5	5	16.5	2xØ5
HU11M2, HU15M2	107	143	152	67.3	49	93	121.5	5	16.5	2xØ5
HU22M3										
H037N4...HU15N4										
H075S6, HU15S6										
HU22M2	142	184	152	88.8	48	126	157	6.5	20.5	4xØ5
HU30M3, HU40M3										
HU22N4...HU40N4										
HU22S6, HU40S6										

Drives (continued)

ATV 312HU55M3, HU75M3, ATV 312HU55N4, HU75N4, ATV 312HU55S6, HU75S6

EMC mounting plate (supplied with the drive)

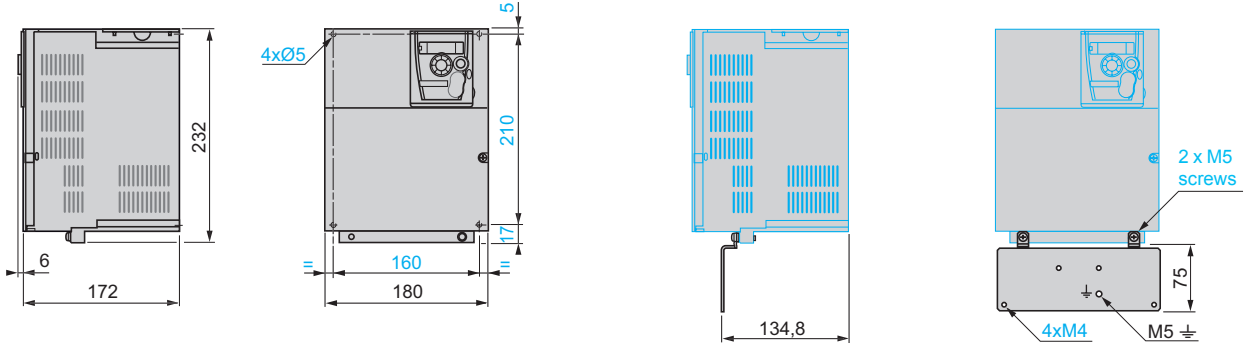

ATV 312HD11M3, HD15M3, ATV 312HD11N4, HD15N4, ATV 312HD11S6, HD15S6

EMC mounting plate (supplied with the drive)

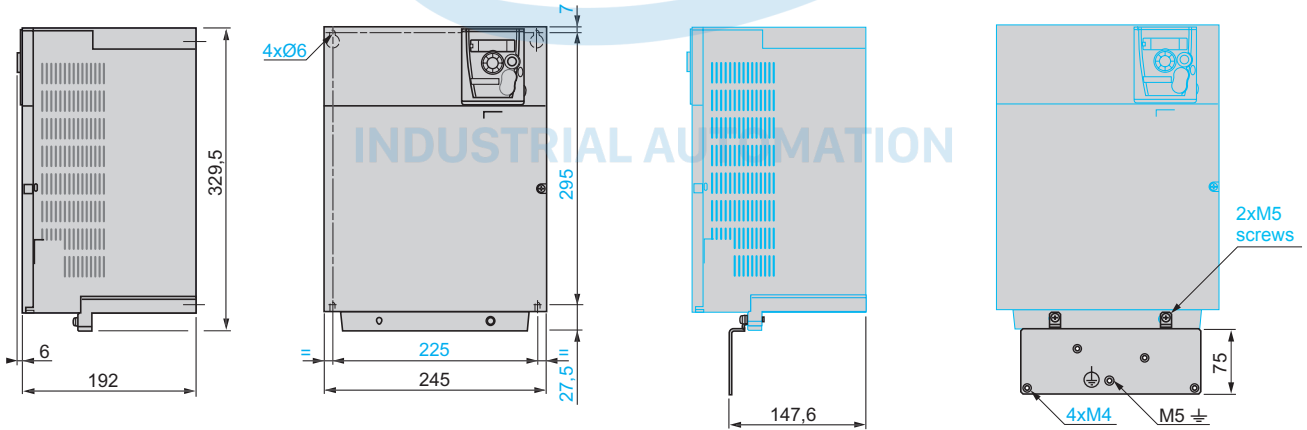

Altivar 312
Accessories and remote display terminal

Accessories

Plates for mounting on  rail

VW3 A9 804

VW3 A9 805

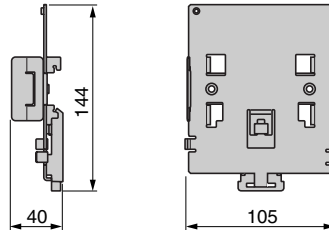
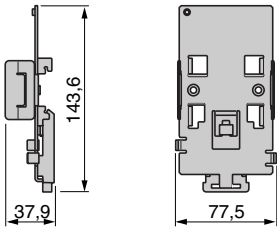

UL Type 1 conformity kits

VW3 A31 811...817

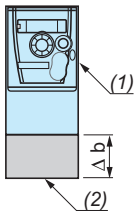

VW3	Δ b
A31 811...A31 815	68
A31 816	96
A31 817	99

- (1) Drive
- (2) VW3 A31 81● kit

Options

IP 54 remote display terminal

VW3 A1 006

IP 65 remote display terminal

VW3 A1 007

Cut-outs and drill holes

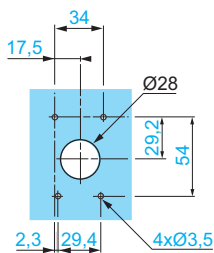
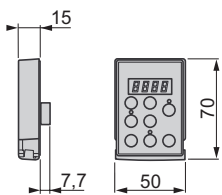

Cut-outs and drill holes

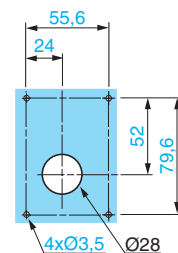
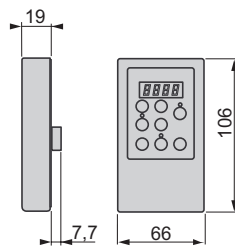

Altivar 312
Braking resistors

Options (continued)

Non-protected braking resistors

VW3 A7 723, 724

2-wire output, length 0.5 m

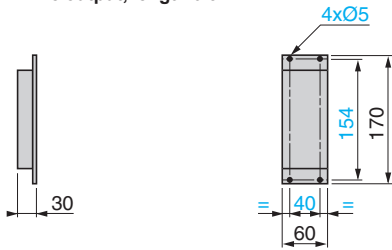

VW3 A7 725

2-wire output, length 0.5 m

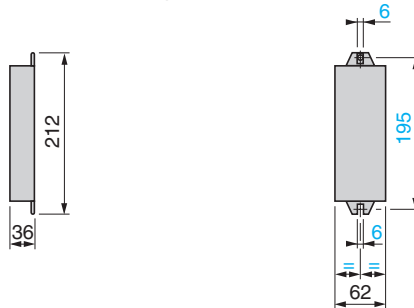

Protected braking resistors

VW3 A7 701...703

Installation recommendations

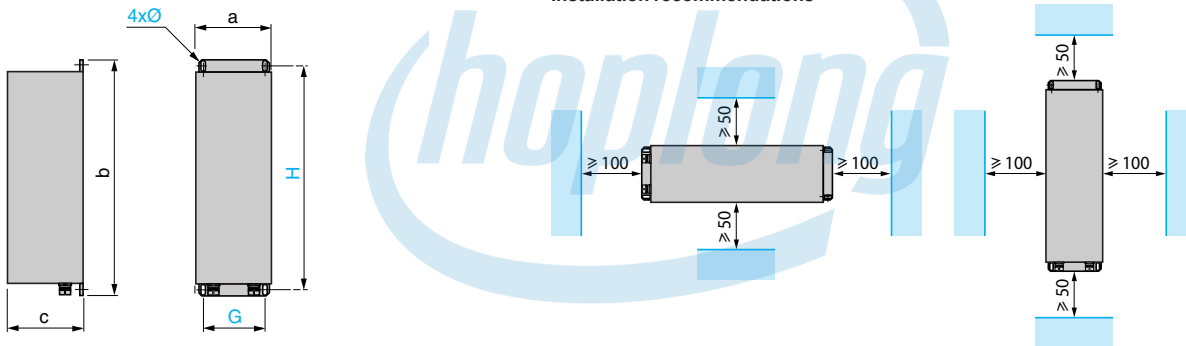

VW3	a	b	c	G	H	Ø
A7 701	95	295	95	70	275	6 x 12
A7 702	95	395	95	70	375	6 x 12
A7 703	140	395	120	120	375	6 x 12

VW3 A7 704, 705

Installation recommendations

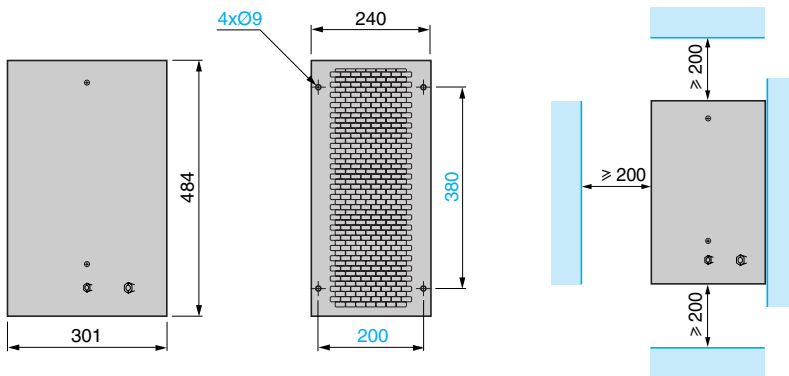

Options (continued)

Line chokes

VZ1 L004M010, L007UM50, L018UM20

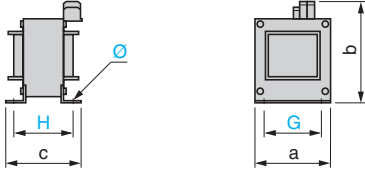

VZ1	a	b	c	G	H	Ø
L004M010	60	100	80	50	44	4 x 9
L007UM50	60	100	95	50	60	4 x 9
L018UM20	85	120	105	70	70	5 x 11

Line chokes and motor chokes

VW3 A4 551...555

VW3 A4 556

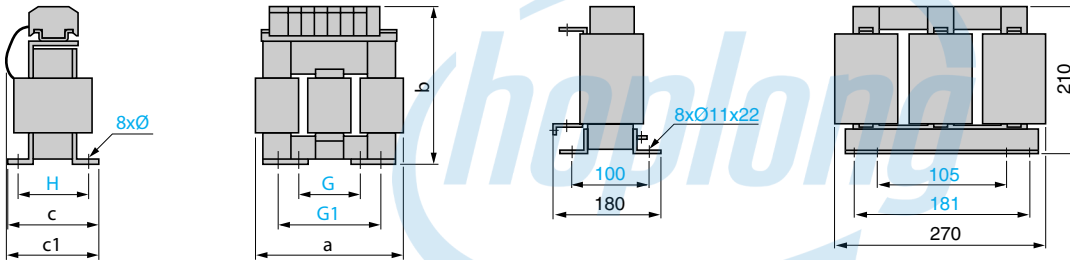

VW3	a	b	c	c1	G	G1	H	Ø
A4 551	100	135	55	60	40	60	42	6 x 9
A4 552, 553	130	155	85	90	60	80.5	62	6 x 12
A4 554	155	170	115	135	75	107	90	6 x 12
A4 555	180	210	125	165	85	122	105	6 x 12

Additional EMC input filters

Mounting the filter under the drive

Mounting the filter next to the drive

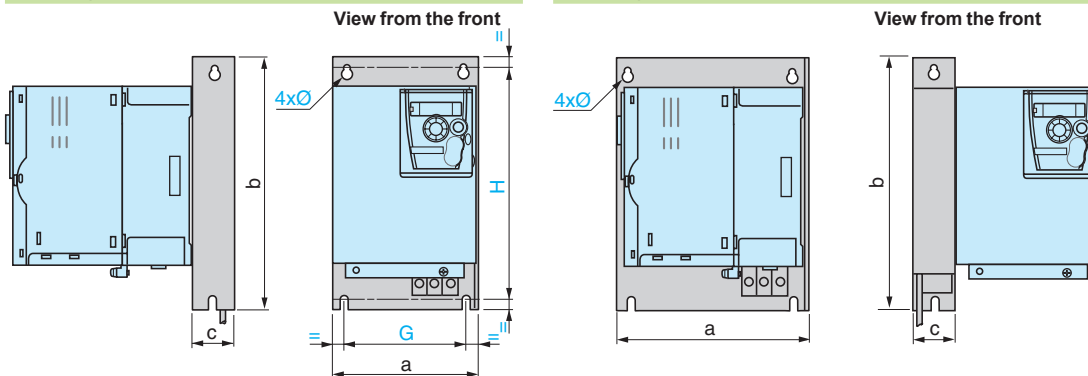

VW3	a	b	c	G	H	Ø
A31401, 402	72	195	37	52	180	4.5
A31403	107	195	35	85	180	4.5
A31404	107	195	42	85	180	4.5
A31405	140	235	35	120	215	4.5
A31406	140	235	50	120	215	4.5
A31407	180	305	60	140	285	5.5
A31408	245	395	80	205	375	5.5
A31409	245	395	60	205	375	5.5

Options (continued)

LR filter cells

VW3 A58451...453

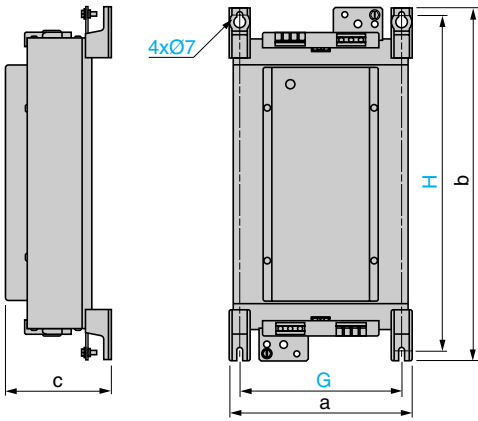

VW3	a	b	c	G	H
A58451	169.5	340	123	150	315
A58452					
A58453	239	467.5	139.5	212	444

Ferrite suppressors for downstream contactor opening

VW3 A31451...453

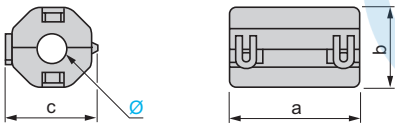

VW3	a	b	c	Ø
A31451	33.5	33	33	13
A31452	33	21.5	22.5	9
A31453	30	19	19	6

ATV 312H●●●M2

Single-phase power supply

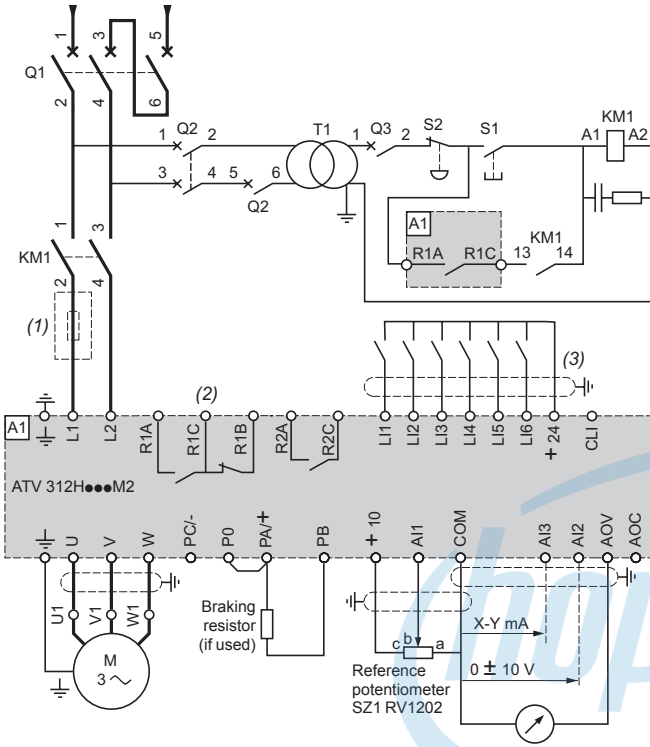

ATV 312H●●●M3, ATV 312H●●●N4, ATV 312H●●●S6

Three-phase power supply

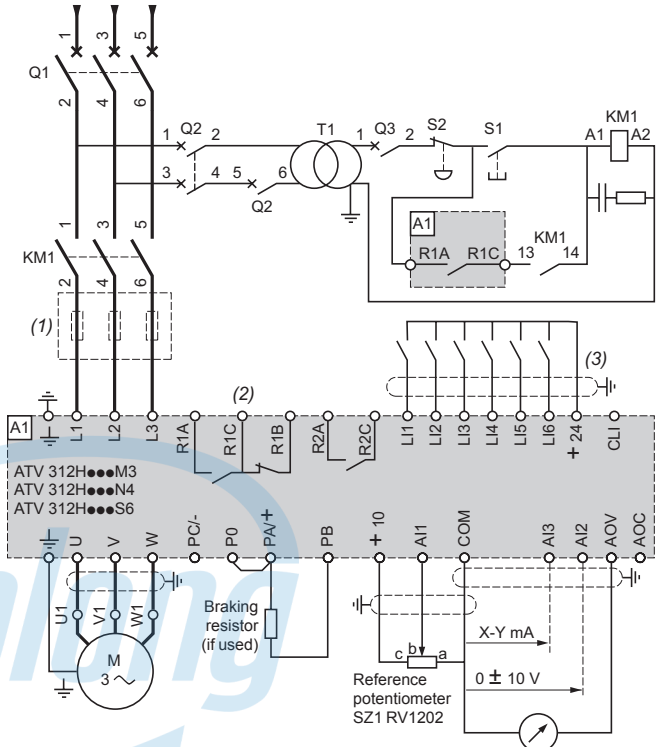

- (1) Line choke (single-phase or three-phase).
- (2) Fault relay contacts. Used for remote signalling of the drive status.
- (3) Connection of the common for the logic inputs depends on the position of the switch (see schemes below).

Note: All terminals are located at the bottom of the drive.
Install interference suppressors on all inductive circuits near the drive or connected on the same circuit, such as relays, contactors, solenoid valves, fluorescent lighting, etc.

Compatible components (for a complete list of references, please refer to the "Motor starter solutions - Control and protection components" catalogue).

Item no.	Designation
KM1	Line contactor LC1 ●●● + suppressor module LA4 DA2U (see page 58)
Q1	GV2 L magnetic circuit-breaker or Compact NS circuit-breaker (see page 58)
Q2	GV2 L magnetic circuit-breaker rated at twice the nominal primary current of T1
Q3	GB2 CB05 thermal magnetic circuit breaker
S1, S2	XB4 B or XB5 A pushbuttons
T1	100 VA transformer 220 V secondary

Examples of recommended schemes

Logic input switches

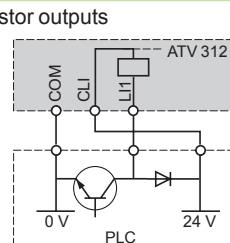
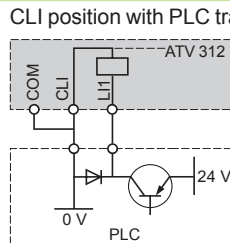
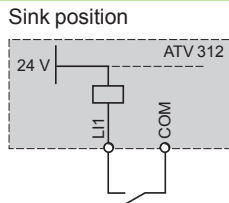
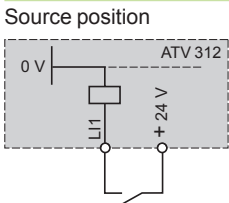

AOC output

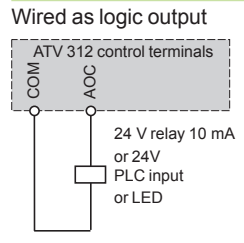

2-wire control

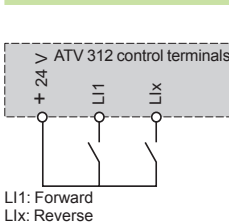

3-wire control

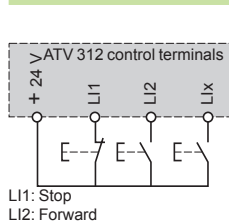

Voltage analog inputs

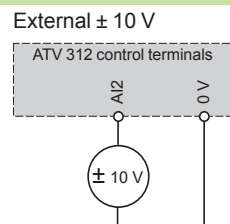
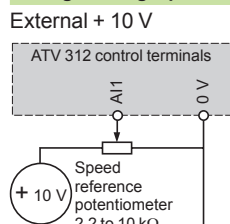

Current analog input

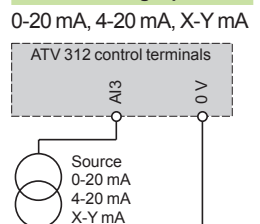

Additional EMC input filters VW3 A31 40●

Single-phase power supply

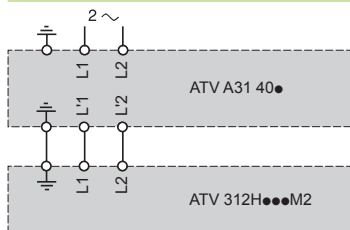

Three-phase power supply

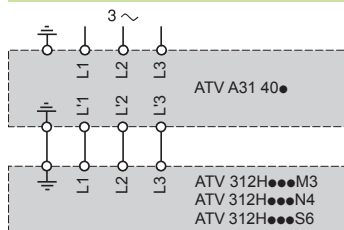

Connections ensuring conformity to EMC standards

Principle

- Earths between the drive, motor and cable shielding must have “high-frequency” equipotentiality.
- Use shielded cables with the shielding connected to earth throughout 360° at both ends for the motor cable, the braking resistor cable and the control-signal cables. Metal conduit or ducting can be used for part of the shielding length provided that there is no break in the continuity of the earth connection.
- Ensure maximum separation between the power supply cable and the motor cable.

Installation diagram

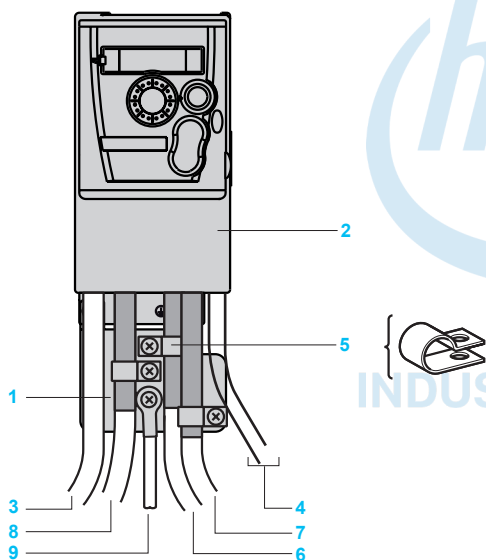

- 1 Steel plate to be mounted on the drive (earthed casing)
- 2 Altivar 312 drive
- 3 Unshielded power supply wires or cable
- 4 Unshielded wires or cable for the output of the fault relay contacts
- 5 Attach and earth the shielding of cables 6, 7 and 8 as close as possible to the drive:
 - Strip the cable to expose the shielding
 - Attach the cable to the plate 1, attaching the clamp on the stripped part of the shielding.
 The shielding must be clamped tightly enough to the metal sheet to ensure good contact.
- For cables 6, 7 and 8, the shielding must be connected to earth at both ends. The shielding must be continuous, and if intermediate terminals are used, they must be placed in EMC shielded metal boxes.
- 6 Shielded cable for connecting the motor
- 7 Shielded cable for connecting the control-signal wiring. For applications requiring several conductors, use cables with a small cross-section (0.5 mm²).
- 8 Shielded cable for connecting the braking resistor
- 9 PE cable (green-yellow)

Note: The HF equipotential earth connection between the drive, motor and cable shielding does not remove the need to connect the PE conductors (green-yellow) to the appropriate terminals on each device. If using an additional EMC input filter, it must be mounted under the drive and connected directly to the line supply via an unshielded cable. Link 3 on the drive is then via the filter output cable.

Operation on an IT system (isolated or impedance earthed neutral)

Use a permanent insulation monitor compatible with non-linear loads, such as the Schneider Electric XM200 (please consult our website www.schneider-electric.com or contact your Customer Care Center).

ATV 312H●●M2 and ATV 312H●●N4 drives have integrated EMC filters. For use on an IT system, these filters can be disconnected by removing their earth connection:

- For ATV 312H018M2...HU22M2 and H037N4...HU40N4 drives, remove a jumper to disconnect the filter.
- For ATV 312HU55N4...HD15N4 drives, move the wire with the cable tag to disconnect the filter.

Installation recommendations

Depending on the conditions in which the drive is to be used, its installation will require certain precautions and the use of appropriate accessories.

Install the unit vertically, at $\pm 10^\circ$:

- Do not place it close to heating elements
- Leave sufficient free space to ensure that the air required for cooling purposes can circulate from the bottom to the top of the unit



Mounting types

■ **Type A mounting**

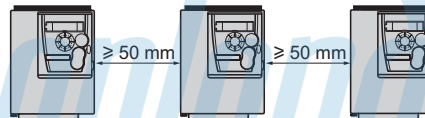

■ **Type B mounting**

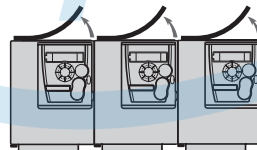

■ **Type C mounting**

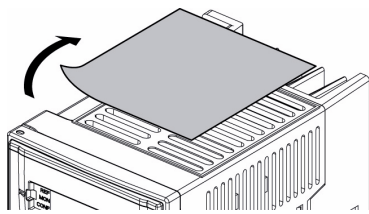
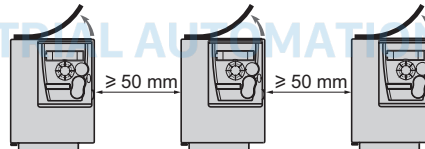

Removing the protective cover

Removing the protective cover from the top of the drive (as shown opposite) changes the degree of protection to IP 20.

Derating curves for the nominal drive current (I_n) as a function of temperature, switching frequency and mounting type.

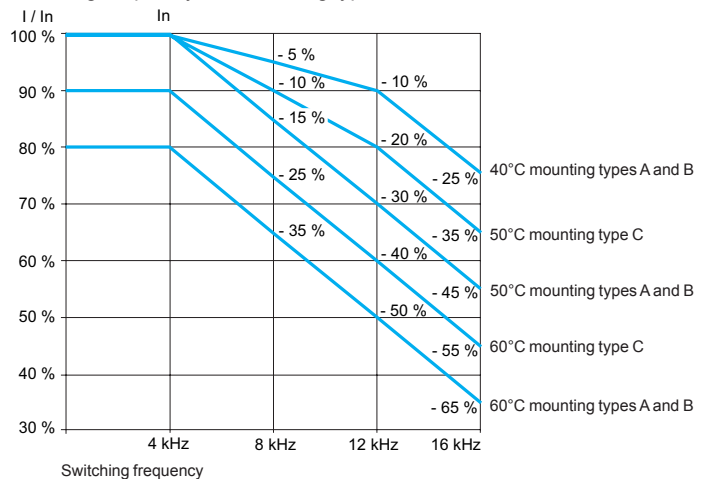

For intermediate temperatures (for example, 55°C), interpolate between 2 curves.

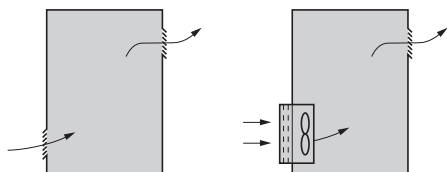

Specific recommendations for mounting in an enclosure

Follow the mounting recommendations on the opposite page.

To ensure proper air circulation in the drive:

- Install ventilation grilles
- Ensure that there is sufficient ventilation. If there is not, install a forced ventilation unit with a filter. The openings and/or fans must provide a flow rate at least equal to that of the drive fans (see below).
- Use special filters with IP 54 protection
- Remove the protective cover from the top of the drive

Fan flow rate depending on the drive rating

ATV 312	Flow rate m ³ /min
H018M2...H055M2 H018M3...H055M3 H037N4...HU11N4 H075S6, HU15S6	0.3
H075M2...HU15M2 H075M3...HU15M3 HU15N4, HU22N4 HU22S6, HU40S6	0.55
HU22M2 HU22M3...HU40M3 HU30N4, HU40N4 HU55S6, HU75S6	1.55
HU55M3 HU55N4, HU75N4 HD11S6	1.7
HU75M3, HD11M3 HD11N4, HD15N4 HD15S6	2.8
HD15M3	3.6

Metal dust and damp proof wall-mounted or floor-standing enclosure (IP 54 degree of protection)

The drive must be mounted in a dust and damp proof enclosure in certain environmental conditions: dust, corrosive gases, high humidity with risk of condensation and dripping water, splashing liquid, etc.

This enables the drive to be used in an enclosure where the maximum internal temperature can reach 50°C.

Calculating the dimensions of the enclosure

Maximum thermal resistance Rth (°C/W)

$$R_{th} = \frac{\theta^{\circ} - \theta_e}{P}$$

θ° = maximum temperature inside the enclosure in °C
 θ_e = maximum external temperature in °C
 P = total power dissipated in the enclosure in W

Power dissipated by drive: see page 26.

Add the power dissipated by the other components of the device.

Useful heat exchange area of enclosure S (m²)

(sides + top + front panel if wall-mounted)

$$S = \frac{K}{R_{th}}$$

K = thermal resistance per m² of the enclosure

For metal enclosures:

- K = 0.12 with internal fan
- K = 0.15 without fan

Note: Do not use insulated enclosures, as they have a poor level of conductivity.

Variable speed drives
Altivar 312
Motor starters

Applications

The combinations listed below can be used to assemble a complete motor starter comprising a circuit-breaker, a contactor and an Altivar 312 variable speed drive. The circuit-breaker provides protection against accidental short-circuits, disconnection and, if necessary, isolation. The contactor controls and manages any safety features and isolates the motor on stopping. The Altivar 312 drive is protected electronically against short-circuits between phases and between phase and earth. It therefore ensures continuity of service and thermal protection of the motor.



Motor starters

Standard power rating of 50/60 Hz 4-pole motors (1)		Drive	Circuit-breaker		Contactor (2)
		Reference	Reference	Rating	Add voltage reference to basic reference to obtain full reference (3)
kW	HP			A	
Single-phase supply voltage: 200...240 V					
0.18	0.25	ATV 312H018M2	GV2 L08	4	LC1 D09●●
0.37	0.5	ATV 312H037M2	GV2 L10	6.3	LC1 D09●●
0.55	0.75	ATV 312H055M2	GV2 L14	10	LC1 D09●●
0.75	1	ATV 312H075M2	GV2 L14	10	LC1 D09●●
1.1	1.5	ATV 312HU11M2	GV2 L16	14	LC1 D09●●
1.5	2	ATV 312HU15M2	GV2 L20	18	LC1 D09●●
2.2	3	ATV 312HU22M2	GV2 L22	25	LC1 D09●●
Three-phase supply voltage: 200...240 V					
0.18	0.25	ATV 312H018M3	GV2 L07	2.5	LC1 D09●●
0.37	0.5	ATV 312H037M3	GV2 L08	4	LC1 D09●●
0.55	0.75	ATV 312H055M3	GV2 L10	6.3	LC1 D09●●
0.75	1	ATV 312H075M3	GV2 L14	10	LC1 D09●●
1.1	1.5	ATV 312HU11M3	GV2 L14	10	LC1 D09●●
1.5	2	ATV 312HU15M3	GV2 L16	14	LC1 D09●●
2.2	3	ATV 312HU22M3	GV2 L20	18	LC1 D09●●
3	–	ATV 312HU30M3	GV2 L22	25	LC1 D09●●
4	5	ATV 312HU40M3	GV2 L22	25	LC1 D09●●
5.5	7.5	ATV 312HU55M3	GV3 L40	40	LC1 D32●●
7.5	10	ATV 312HU75M3	GV3 L50	50	LC1 D32●●
11	15	ATV 312HD11M3	GV3 L65	65	LC1 D50●●
15	20	ATV 312HD15M3	NS100HMA	100	LC1 D80●●
Three-phase supply voltage: 380...500 V					
0.37	0.5	ATV 312H037N4	GV2 L07	2.5	LC1 D09●●
0.55	0.75	ATV 312H055N4	GV2 L08	4	LC1 D09●●
0.75	1	ATV 312H075N4	GV2 L08	4	LC1 D09●●
1.1	1.5	ATV 312HU11N4	GV2 L10	6.3	LC1 D09●●
1.5	2	ATV 312HU15N4	GV2 L14	10	LC1 D09●●
2.2	3	ATV 312HU22N4	GV2 L14	10	LC1 D09●●
3	–	ATV 312HU30N4	GV2 L16	14	LC1 D09●●
4	5	ATV 312HU40N4	GV2 L16	14	LC1 D09●●
5.5	7.5	ATV 312HU55N4	GV2 L22	25	LC1 D09●●
7.5	10	ATV 312HU75N4	GV2 L32	32	LC1 D18●●
11	15	ATV 312HD11N4	GV3 L40	40	LC1 D25●●
15	20	ATV 312HD15N4	GV3 L50	50	LC1 D32●●

(1) The values expressed in HP conform to the NEC (National Electrical Code).
 (2) Composition of contactors LC1-D09/D18/D25/D32/D50/D80:
 3 poles + 1 N/O auxiliary contact + 1 N/C auxiliary contact.
 (3) Replace ●● with the control circuit voltage reference indicated in the table below:

AC control circuit	Volts ~						
	24	48	110	220	230	230/240	
LC1-D	50/60 Hz	B7	E7	F7	M7	P7	U7

For other voltages between 24 V and 660 V, or a DC control circuit, please refer to the "Motor starter solutions - Control and protection components" catalogue.

Variable speed drives

Altivar 312
Motor starters

PFES0853



PFES0854



PFES0855



GV3 L40
+
LC1 D25
+
ATV 312HD15S6

Motor starters (continued)

Standard power rating of 50/60 Hz 4-pole motors (1)		Drive	Circuit-breaker		Contactor (2)
		Reference	Reference	Rating	Add voltage reference to basic reference to obtain full reference (3)
kW	HP			A	
Three-phase supply voltage: 525...600 V					
0.75	1	ATV 312H075S6	GV2 L08	4	LC1 D09●●
1.5	2	ATV 312HU15S6	GV2 L10	6.3	LC1 D09●●
2.2	3	ATV 312HU22S6	GV2 L14	10	LC1 D09●●
4	5	ATV 312HU40S6	GV2 L16	14	LC1 D09●●
5.5	7.5	ATV 312HU55S6	GV2 L20	18	LC1 D09●●
7.5	10	ATV 312HU75S6	GV2 L22	25	LC1 D09●●
11	15	ATV 312HD11S6	GV2 L32	32	LC1 D18●●
15	20	ATV 312HD15S6	GV3 L40	40	LC1 D25●●

(1) The values expressed in HP conform to the NEC (National Electrical Code).

(2) Composition of contactors LC1-D09/D18/D25:

3 poles + 1 N/O auxiliary contact + 1 N/C auxiliary contact.

(3) Replace ●● with the control circuit voltage reference indicated in the table below:

AC control circuit

	Volts ~	24	48	110	220	230	230/240
LC1-D	50/60 Hz	B7	E7	F7	M7	P7	U7

For other voltages between 24 V and 660 V, or a DC control circuit, please refer to the "Motor starter solutions - Control and protection components" catalogue.

INDUSTRIAL AUTOMATION

Summary of functions	
Drive factory configuration	
Presentation	page 61
Human-Machine Interface (HMI)	
Description	page 61
Application functions	
Operating speed range	page 62
Acceleration and deceleration ramp times	page 62
Acceleration and deceleration ramp profiles	page 62
Ramp switching	page 63
Automatic adaptation of deceleration ramp	page 63
Voltage/frequency ratio	page 64
Auto-tuning	page 64
Switching frequency, noise reduction	page 64
Skip frequencies	page 65
Speed reference	page 65
Analog inputs	page 65
Preset speeds	page 65
+/- speed	page 66
Save reference	page 66
Jog operation	page 67
Command and reference channels	page 67
Reference switching	page 67
Summing inputs	page 67
PI regulator	page 68
Current limit switching	page 68
Limiting low speed operating time	page 68
Motor switching	page 68
Control mode switching	page 69
2-wire control	page 69
3-wire control	page 69
Forced local mode	page 69
Freewheel stop	page 69
Fast stop	page 69
DC injection stop	page 69
Brake control	page 70
Limit switch management	page 70
Monitoring	page 70
Fault management	page 71
Fault reset	page 71
General reset (disables all faults)	page 71
Controlled stop on loss of line supply	page 71
Stop mode in the event of a fault	page 71
Automatic catching of a spinning load with speed detection ("catch on the fly")	page 72
Automatic restart	page 72
Derated operation in the event of an undervoltage	page 72
Fault relay, unlocking	page 72
Resetting operating time to zero	page 72
Motor thermal protection	page 73
Drive thermal protection	page 73
R1, R2 relay configuration	page 73
AOC/AOV analog outputs	page 74
Saving and retrieving the configuration	page 74
Function compatibility table	
Presentation	page 75

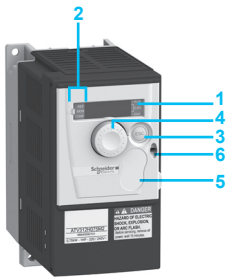

ATV 312H075M2 with front panel door closed, with cover 5: STOP/RESET and RUN keys not accessible

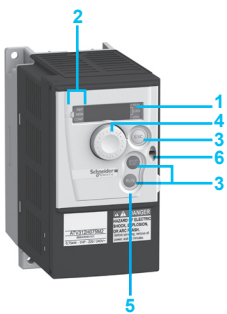

ATV 312H075M2 with front panel door closed, without cover 5: STOP/RESET and RUN keys accessible

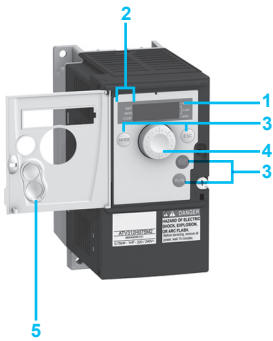

ATV 312H075M2 with front panel door open

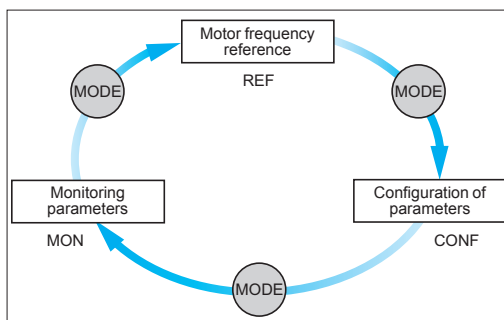

3 operating modes: REF, MON and CONF

Drive factory configuration

The Altivar 312 drive is configured to allow a quick start-up for most applications. Factory configuration:

- Nominal motor frequency: 50 Hz
- Motor voltage: 230 V (ATV 312H●●●M2, ATV 312H●●●M3), 400 V (ATV 312H●●●N4) or 600 V (ATV 312H●●●S6)
- Linear ramp times: 3 seconds
- Low speed (LSP): 0 Hz/High speed (HSP): 50 Hz
- Normal stop mode on deceleration ramp
- Stop mode in the event of a fault: freewheel
- Motor thermal current = nominal drive current
- Standstill injection braking current = 0.7 x nominal drive current, for 0.5 seconds
- Constant torque operation with sensorless flux vector control
- Logic inputs:
 - 2 directions of operation (LI1, LI2), 2-wire control
 - 4 preset speeds (LI3, LI4): LSP (low speed), 10 Hz, 15 Hz, 20 Hz
- Analog inputs:
 - AI1 speed reference (0 +10 V)
 - AI2 (0 ± 10 V) summing of AI1
 - AI3 (4-20 mA) not configured
- Relay R1: fault relay
- Relay R2: not assigned
- Analog output AOC: 0-20 mA, image of the motor frequency
- Automatic adaptation of the deceleration ramp in the event of overbraking
- Switching frequency 4 kHz, random frequency

Human-Machine Interface (HMI)

Description

- 1 Display:
 - 4-digit display
 - Display of numeric values and codes
 - Indication of the unit of the displayed value
- 2 Display of the drive status:
 - **REF**: Reference mode. This mode is used to display the motor frequency reference of the active reference channel (terminals, local mode, remote display terminal or Modbus serial link). In local mode, the reference can be modified using the navigation button 4, if the function is configured.
 - **MON**: Monitoring mode. This mode is used to display the monitoring parameters when the drive is running.
 - **CONF**: Configuration mode. This mode is used to configure the drive parameters. These parameters can be modified using the SoMove setup software.
- 3 Use of the keys:
 - **MODE** is used to access one of the following modes:
 - Reference mode REF
 - Monitoring mode MON
 - Configuration mode CONF
 - Note**: This key cannot be accessed if the front panel door is closed.
 - **ESC**: Aborts a value, a parameter or a menu to return to the previous selections
 - **STOP/RESET**: Local motor stop command, clears drive faults (key active in factory configuration)
 - **RUN**: Local motor run command, if its activation is programmed
- 4 Use of the navigation button:
 - Rotate: Increases or decreases the value, or goes to the next value
 - Press: Saves the current value or selects the value
 - The button can be used as a potentiometer in local mode
- 5 Cover that can be removed for access to the RUN and STOP/RESET keys.
- 6 It is possible to lock the front panel door with a lead seal.

Application functions

■ **Operating speed range**

This function is used to determine the 2 frequency limits which define the speed range permitted by the machine under actual operating conditions for all applications with or without overspeed.

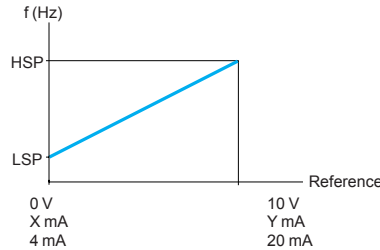

LSP: low speed, from 0 to HSP, factory setting 0
HSP: high speed, from LSP to f max., factory setting 50 Hz
X: configurable between 0 and 20 mA, factory setting 4 mA
Y: configurable between 4 and 20 mA, factory setting 20 mA

■ **Acceleration and deceleration ramp times**

This function is used to define acceleration and deceleration ramp times according to the application and the machine dynamics.

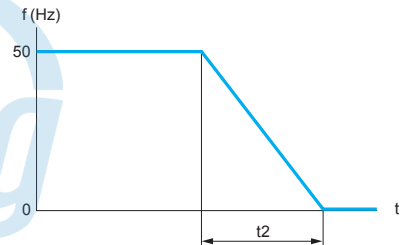
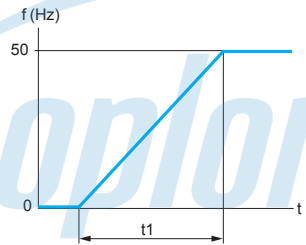

Linear acceleration ramp

Linear deceleration ramp

t1: acceleration time
t2: deceleration time

t1 and t2 can be set independently between 0.1 and 999.9 s, factory setting: 3 s

■ **Acceleration and deceleration ramp profiles**

These enable a gradual change in the output frequency starting from a speed reference, following a linear profile or a preset profile.

□ **S ramps**

For applications such as material handling, packaging and passenger transport, the use of S ramps takes up mechanical backlash, eliminates jolts, and limits "non-following" of speed during rapid transient operation of high-inertia machines.

□ **U ramps**

U ramps are specifically for pumping applications, for example an installation with centrifugal pump and non-return valve. They provide better control of closing of the non-return valve.

Selecting linear, S, U or customized profiles assigns both the acceleration and deceleration ramps.

S ramps

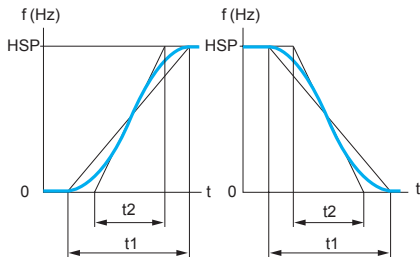

HSP: high speed
t1: ramp time set
t2 = 0.6 x t1
The rounding coefficient is fixed.

U ramps

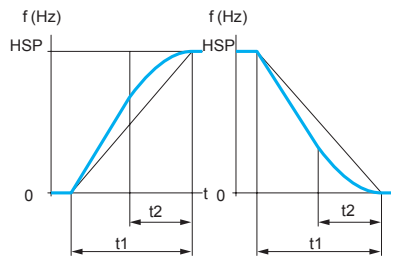

HSP: high speed
t1: ramp time set
t2 = 0.5 x t1
The rounding coefficient is fixed.

Customized ramps

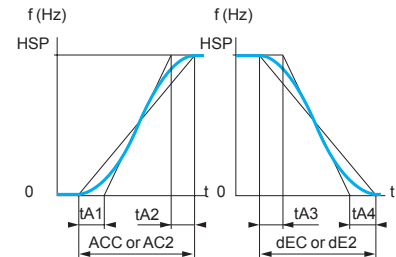

HSP: high speed
tA1: adjustable between 0 and 100% (of ACC or AC2)
tA2: can be set between 0 and (100% - tA1) (of ACC or AC2)
tA3: can be set between 0 and 100% (of dEC or dE2)
tA4: can be set between 0 and (100% - tA3) (of dEC or dE2)
ACC: acceleration ramp 1 time
AC2: acceleration ramp 2 time
dEC: deceleration ramp 1 time
dE2: deceleration ramp 2 time

■ Ramp switching

This function is used to switch two acceleration and deceleration ramp times, which can be adjusted separately.

Ramp switching can be enabled by:

- A logic input
- A frequency threshold
- A combination of logic input and frequency threshold

This function is suitable for:

- Material handling with smooth starting and approach
- Machines with fast steady state speed correction

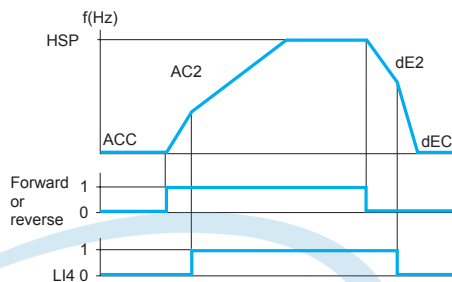

Acceleration 1 (ACC) and deceleration 1 (dEC):
 - Adjustment 0.1 to 999.9 s
 - Factory setting 3 s
 Acceleration 2 (AC2) and deceleration 2 (dE2):
 - Adjustment 0.1 to 999.9 s
 - Factory setting 5 s
 HSP: high speed

Example of switching using logic input LI4

■ Automatic adaptation of deceleration ramp

This function is used to automatically adapt the deceleration ramp if the initial setting is too low for the inertia of the load. It avoids the drive locking in the event of an **overbraking** fault.

The function is suitable for all applications which do require precise stopping and do not use braking resistors.

Automatic adaptation must be cancelled if the machine has position control with stopping on a ramp and a braking resistor installed. It is automatically disabled if the brake sequence is configured.

Variable speed drives Altivar 312

■ **Voltage/frequency ratio**

□ Motor and power supply characteristics

This function is used to determine the limit values for the voltage/frequency ratio according to the characteristics of the line supply, motor and application.

The following values should be set for constant or variable torque applications with or without overspeed:

- The base frequency corresponding to the line supply
- The nominal motor frequency (in Hz) given on the motor rating plate
- The nominal motor voltage (in V) given on the motor rating plate
- The maximum output frequency of the drive (in Hz)

□ Type of voltage/frequency ratio

This is used to adapt the voltage/frequency ratio to the application in order to optimize performance for the following applications:

- Constant torque applications (machines with average loads operating at low speed) with motors connected in parallel or special motors (e.g. resistive cage motor): ratio **L**
- Variable torque applications (pumps, fans): ratio **P**
- Machines with heavy loads operating at low speed, machines with fast cycles, with (sensorless) flux vector control: ratio **n**
- Energy saving, for machines with slow torque and speed variations: ratio **nLd**.

The voltage is automatically reduced to minimum according to the necessary torque.

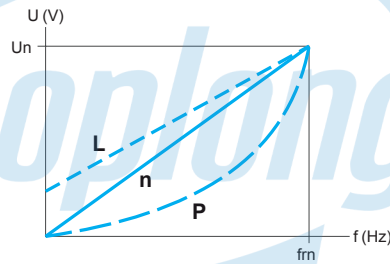

Un: nominal motor voltage
fm: nominal motor frequency

■ **Auto-tuning**

Auto-tuning can be performed:

- Voluntarily by the operator using dialogue tools via local control or the serial link
- Each time the drive is switched on
- On each run command
- By enabling a logic input

Auto-tuning is used to optimize application performance.

■ **Switching frequency, noise reduction**

Adjusting the switching frequency setting reduces the noise generated by the motor. The switching frequency is modulated randomly in order to avoid resonance. This function can be disabled if it causes instability.

High frequency switching of the intermediate DC voltage can be used to supply the motor with a current wave that has little harmonic distortion. The switching frequency can be adjusted during operation to reduce the noise generated by the motor.

Value: 2 to 16 kHz. Factory setting 4 kHz

For all applications which require low motor noise.

Variable speed drives Altivar 312

■ Skip frequencies

This function suppresses one or two critical speeds that may cause mechanical resonance.

It is possible to prohibit prolonged operation of the motor on 1 or 2 frequency bands (± 1 Hz), around an adjustable frequency on the speed range.

This function is suitable for lightweight machines, bulk product conveyors with an unbalanced motor, fans and centrifugal pumps.

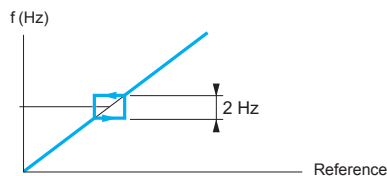

Motor speed change depending on the skip frequency reference

■ Speed reference

The speed reference can come from different sources, depending on the drive configuration:

- References provided by 3 analog inputs
 - The navigation button reference
 - The +/- speed function via logic input, using the keypad or remote display terminal keys
 - The remote display terminal reference
 - Speed references provided by the communication bus or networks
- These sources are managed by programming the reference functions and channels.

■ Analog inputs

There are 3 analog inputs:

- 2 voltage inputs:
 - 0-10 V (AI1)
 - ± 10 V (AI2)
- 1 current input:
 - X-Y mA (AI3), where X is configurable between 0 and 20 mA, and Y is configurable between 4 and 20 mA

■ Preset speeds

This function is used to switch preset speed references.

Choose between 2, 4, 8 or 16 preset speeds.

Enabled by means of 1, 2, 3 or 4 logic inputs.

The preset speeds are adjustable in increments of 0.1 Hz from 0 Hz to 500 Hz.

This function is suitable for material handling and machines with several operating speeds.

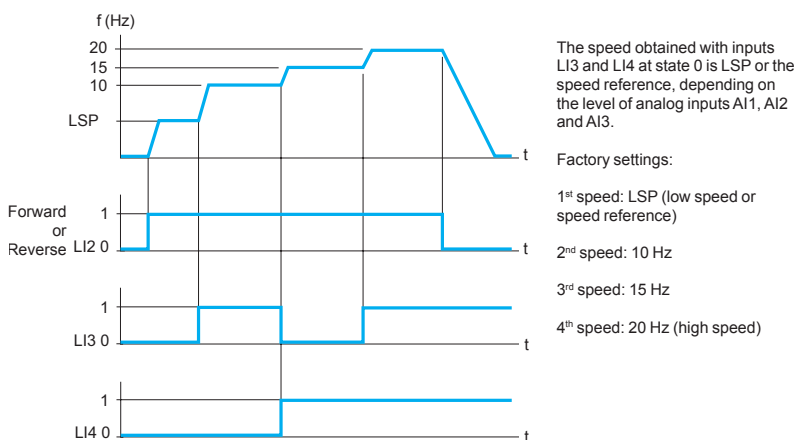

The speed obtained with inputs L13 and L14 at state 0 is LSP or the speed reference, depending on the level of analog inputs AI1, AI2 and AI3.

Factory settings:

- 1st speed: LSP (low speed or speed reference)
- 2nd speed: 10 Hz
- 3rd speed: 15 Hz
- 4th speed: 20 Hz (high speed)

Example of operation with 4 preset speeds and 2 logic inputs

■ +/- speed

This function is used to increase or decrease a speed reference by means of 1 or 2 logic inputs, with or without the last reference being saved (motorized potentiometer function).

This function is suitable for centralized control of a machine with several sections operating in one direction or for control by a pendant control station of a material handling crane with two operating directions.

Two types of operation are available:

- Use of single-action buttons: two logic inputs are required in addition to the operating direction(s).

The input assigned to the + speed command increases the speed, the input assigned to the - speed command decreases the speed.

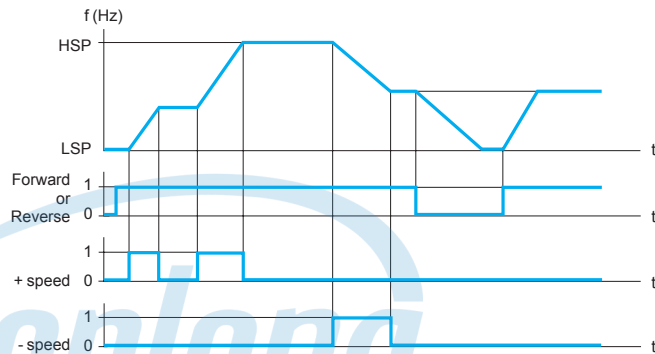

Example of +/- speed with 2 logic inputs, single-action buttons and reference saving

- Use of double-action buttons (only one logic input assigned to + speed is necessary).

Logic inputs:

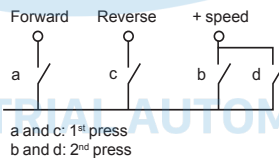

	Released (- speed)	1 st press (speed maintained)	2 nd press (+ speed)
Forward button	-	a	a and b
Reverse button	-	c	c and d

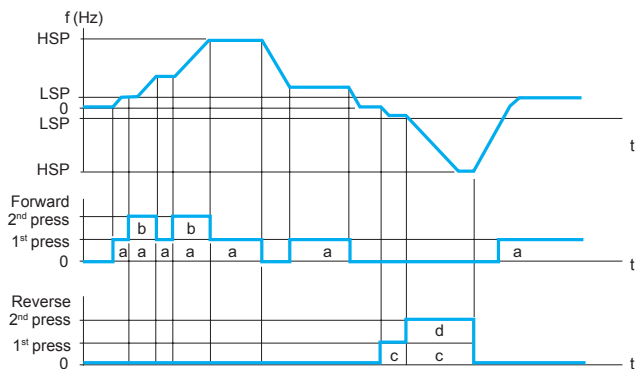

LSP: low speed; HSP: high speed

Example with double-action buttons and 1 logic input

Note: This type of +/- speed control is incompatible with 3-wire control.

■ Save reference

This function is associated with +/- speed control.

It enables the last speed reference prior to the loss of the run command or line supply to be read and saved. The saved reference is applied to the next run command.

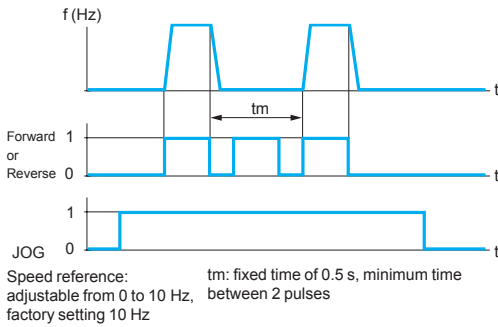

Example of jog operation

■ Jog operation

This function is used for pulse operation with minimum ramp times (0.1 s), a limited speed reference and minimum time between 2 pulses. It is enabled by 1 logic input and pulses given by the operating direction command.

This function is suitable for machines with product insertion in manual mode (e.g. gradual movement of the mechanism during maintenance operations).

■ Command and reference channels

There are several command and reference channels, which can be independent. Commands (forward, reverse, etc.) and speed references can be given via the following channels:

- Terminals (logic inputs and analog I/O)
- Local mode (STOP/RESET and RUN keys and navigation button)
- Remote display terminal
- Serial link:
 - Remote display terminal
 - Modbus control word
 - CANopen control word

The command channels and speed reference channels can be separate. E.g. speed reference issued by CANopen and command issued by the remote display terminal.

Note: The STOP/RESET keys on the Human-Machine interface keypad and the remote display terminal can retain their priority. The Summing inputs and PI regulator functions only apply to one reference channel.

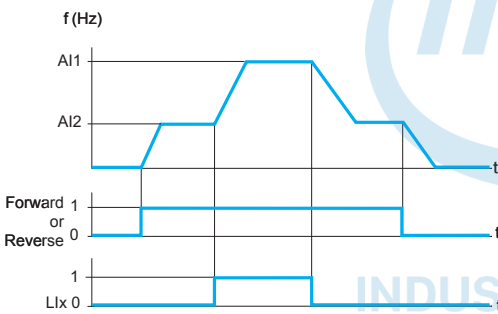

Example of reference switching

■ Reference switching

Switching between 2 speed references can be enabled via:

- A logic input
 - A bit in a Modbus or CANopen control word
- Reference 1 is active if the logic input (or control word bit) is at 0. Reference 2 is active if the logic input (or control word bit) is at 1. The reference can be switched with the motor running.

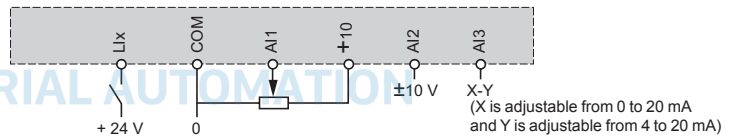

Connection diagram for reference switching

■ Summing inputs

This function is used to add together 2 to 3 speed references from different sources. The references to be added together are selected from all the possible types of speed reference.

- E.g.
- Reference 1 from AI1
 - Reference 2 from AI2
 - Reference 3 from AIP

Drive speed reference = reference 1 + reference 2 + reference 3.

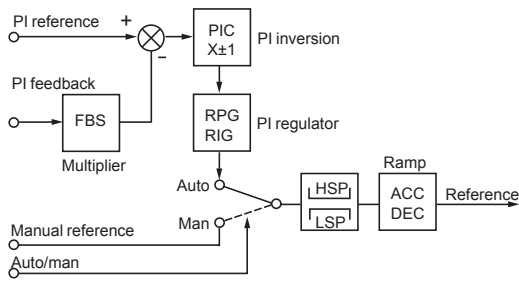

ACC: Acceleration
 DEC: Deceleration
 FBS: PI feedback multiplication coefficient
 HSP: High speed
 PIC: Reversal of the direction of correction of the PI regulator
 LSP: Low speed
 RIG: PI regulator integral gain
 RPG: PI regulator proportional gain

PI feedback

■ **PI regulator**

This function is used for simple control of a flow rate or a pressure with a sensor supplying a feedback signal adapted to the drive. It is suitable for pumping and ventilation applications.

□ **PI reference:**

- Internal regulator reference, adjustable from 0 to 100
- Regulation reference selected from all the possible types of regulation reference
- Preset PI references
- **2 or 4 preset PI references** adjustable from 0 to 100, require the use of 1 or 2 logic inputs respectively

□ **Manual reference**

- Speed reference selected from all the possible types of speed reference

□ **PI feedback:**

- Analog input AI1, AI2 or AI3

□ **Auto/Man:**

- Logic input LI for switching operation to speed reference (Man) or PI regulation (Auto)

During operation in automatic mode, the process feedback can be adapted to correct inverse PI, adjust the proportional and integral gain, or apply a ramp (time = ACC - DEC) for establishing the PI action on starting and stopping. The motor speed is limited to between LSP and HSP.

Note: The PI function is incompatible with the Preset speeds and JOG functions. The PI reference can also be transmitted on line via the Modbus RS 485 serial link or via the CANopen bus.

■ **Current limit switching**

A second current limit can be configured between 0.25 and 1.5 times the nominal drive current.

This function limits the torque and the temperature rise of the motor.

Switching between the two current limits can be enabled via:

- A logic input
- A bit in a Modbus or CANopen control word

■ **Limiting low speed operating time**

The motor is stopped automatically after a period of operation at low speed (LSP) with a zero reference and a run command present.

This time can be set between 0.1 and 999.9 seconds (0 corresponds to an unlimited time). Factory setting: 0 s. The motor restarts automatically on the ramp when the reference reappears or if the run command is interrupted and then re-established.

This function is suitable for automatic stopping/starting of pressure-regulated pumps.

■ **Motor switching**

This function allows two motors with different powers to be supplied alternately by the same drive. Switching must take place with the drive stopped and locked, using an appropriate sequence at the drive output.

The function can be used to adapt the motor parameters. The following parameters are switched automatically:

- Nominal motor voltage
- Nominal motor frequency
- Nominal motor current
- Nominal motor speed
- Motor cosine Phi (power factor)
- Selection of the type of voltage/frequency ratio for motor 2
- IR compensation, motor 2
- Motor frequency loop gain
- Motor stability
- Motor slip compensation

Motor thermal protection is disabled by this function.

Motor switching can be enabled by:

- A logic input
- A bit in a Modbus or CANopen control word

With hoisting applications, this function enables a single drive to be used for vertical and horizontal movements.

■ **Control mode switching**

Switching the command channel provides a choice of 2 control modes. Switching is enabled by:

- A logic input
- A bit in a Modbus or CANopen control word

■ **2-wire control**

This function is used to control the direction of operation by means of a stay-put contact. It is enabled by means of 1 or 2 logic inputs (one or two directions of operation).

This function is suitable for all non-reversing and reversing applications.

Three operating modes are possible:

- Detection of the state of the logic inputs
- Detection of a change of state of the logic inputs
- Detection of the state of the logic inputs with forward operation having priority over reverse

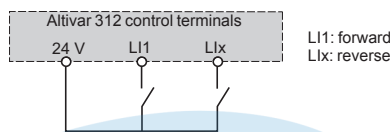

Wiring diagram for 2-wire control

■ **3-wire control**

This function is used to control the operating direction and stopping by means of pulsed contacts.

It is enabled by means of 2 or 3 logic inputs (1 or 2 directions of operation).

It is suitable for all non-reversing and reversing applications.

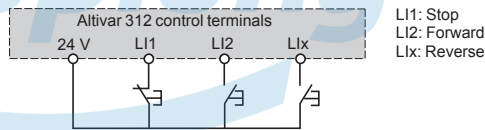

Wiring diagram for 3-wire control

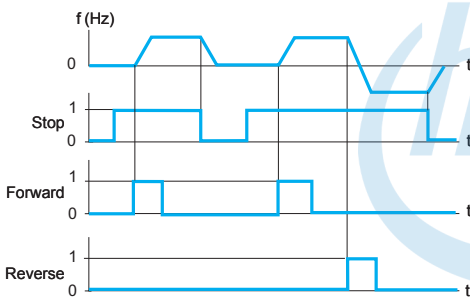

Example of 3-wire control operation

■ **Forced local mode**

Forced local mode imposes control via the terminals or display terminal and disables all other control modes.

The following references and commands are available for forced local mode:

- References AI1, or AI2, or AI3 and command via logic inputs
- Reference and command via RUN and STOP/RESET keys and the navigation button
- Reference and command via the remote display terminal

The changeover to forced local mode is enabled by a logic input.

■ **Freewheel stop**

This stops the motor by resistive torque if the motor power supply is cut.

A freewheel stop is achieved by:

- Configuring a normal stop command as a freewheel stop (on disappearance of a run command or appearance of a stop command)
- Enabling a logic input

■ **Fast stop**

This is used to achieve a braked stop with a deceleration ramp time (divided by 2 to 10) that is acceptable for the drive/motor unit without locking on an overbraking fault. It is used for conveyors with electrical emergency stop braking.

A fast stop is achieved by:

- Configuring a normal stop as a fast stop (on disappearance of a run command or appearance of a stop command)
- By enabling a logic input

■ **DC injection stop**

This function is used for low speed braking of high-inertia fans, or for maintaining torque when stopping fans located in an airflow.

A DC injection stop is achieved by:

- Configuring a normal stop as a DC injection stop (on disappearance of a run command or appearance of a stop command)
- Enabling a logic input

The DC value and the standstill braking time are adjustable.

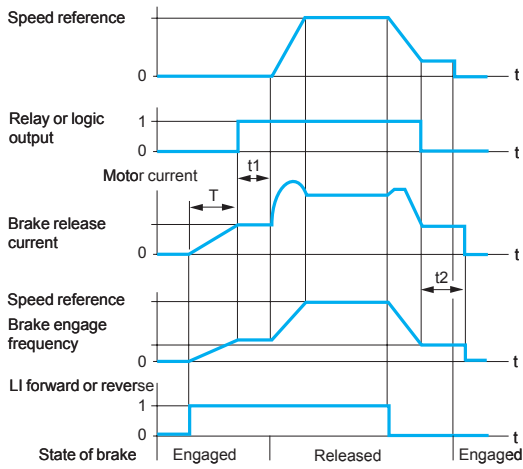

Accessible settings:
 t1: brake release time delay
 t2: brake engage time delay

Brake control

■ **Brake control**

This function is used to manage control of an electromagnetic brake in synchronization with starting and stopping the motor to avoid jolts and speed errors. The brake control sequence is managed by the drive. Adjustable values for releasing the brake: current threshold and time delay. Adjustable values for engaging the brake: frequency threshold and time delay. Enabled by: relay logic output R2 or logic output AOC assigned to brake control. This function is suitable for material handling applications with movements equipped with electromagnetic brakes (hoisting) and machines requiring holding brake control (unbalanced machines).

□ **Principle:**

- Vertical hoisting movement: Maintains motor torque in an upward direction when the brake is being released and engaged, in order to hold the load and start smoothly as soon as the brake is released.
 - Horizontal hoisting movement: Synchronizes brake release with the build-up of torque during starting and brake engage at zero speed on stopping, to prevent jolting. The recommended brake control settings for vertical hoisting applications are as follows (for horizontal hoisting applications, set the current threshold to zero):
 - Brake release current: Set the brake release current to the nominal current indicated on the motor. If, during testing, the torque is insufficient, increase the brake release current (the maximum value is imposed by the drive).
 - Acceleration time: For hoisting applications it is advisable to set the acceleration ramps to more than 0.5 seconds. Ensure that the drive does not change to current limiting. The same recommendation applies for deceleration.
- Note: For a hoisting movement, a braking resistor should be used. Ensure that the selected settings and configurations will not result in dropping or loss of control of the load being lifted.
- Brake release time delay t1: Adjust according to the type of brake. It is the time required for the mechanical brake to release.
 - Brake engage frequency: Set to twice the nominal slip, then adjust according to the result.
 - Brake engage time delay t2: Adjust according to the type of brake. It is the time required for the mechanical brake to engage.

INDUSTRIAL AUTOMATION

■ **Limit switch management**

This function is used to manage the operation of one or two limit switches (with 1 or 2 operating directions). Each limit (forward, reverse) is associated with a logic input. The type of stop that occurs on detection of a limit is configurable as normal, freewheel or fast stop. Following a stop, the motor is permitted to restart in the opposite direction only.

■ **Monitoring**

The following data can be displayed:

- Frequency reference
- Internal PI reference
- Frequency reference (absolute value)
- Output frequency applied to the motor (value signed in two's complement)
- Output frequency in customer units
- Current in the motor
- Motor power: 100% = nominal power
- Line voltage
- Motor thermal state:
 - 100%: nominal thermal state, 118%: motor overload threshold
- Drive thermal state:
 - 100%: nominal thermal state, 118%: drive overload threshold
- Motor torque: 100% = nominal torque
- Last detected fault
- Operating time
- Auto-tuning status
- Configuration and state of logic inputs
- Configuration of analog inputs

■ **Fault management**

There are various operating modes in the event of resettable faults:

- Freewheel stop
- The drive switches to the fallback speed
- The drive maintains the speed at which it was operating when the fault occurred, until the fault disappears
- Stop on ramp
- Fast stop

The following resettable faults are detected:

- Drive overheating
- Motor overheating
- CANopen bus fault
- Modbus serial link failure
- External faults
- Loss of 4-20 mA signal

■ **Fault reset**

This function is used to clear the last fault by means of a logic input.

The restart conditions after a reset are the same as those for a normal power-up. Resets the following faults: overvoltage, overspeed, external fault, drive overheating, output phase loss, DC bus overvoltage, loss of 4-20 mA reference, load slipping, motor overload if the thermal state is less than 100%, serial link fault.

Line supply undervoltage and input phase loss faults are reset automatically when the line supply is restored.

This function is suitable for applications where the drives are difficult to access, for example on moving parts or in material handling systems.

■ **General reset (disables all faults)**

This function disables all faults, including thermal protection (forced operation), and can result in irreparable damage to the drive.

This invalidates the warranty.

This function is suitable for applications where restarting may be crucial (conveyor in an oven, smoke extraction system, machines with solidifying products that need to be removed).

The function is enabled by a logic input.

Fault monitoring is active if the logic input is at state 1.

All faults are reset on a change of state \uparrow of the logic input.

■ **Controlled stop on loss of line supply**

This function is used to control motor stopping on a loss of line supply.

It is suitable for material handling, machines with high inertia, continuous product processing machines.

Possible types of stop:

- Locking of the drive and freewheel stop
- Stop which uses the mechanical inertia to maintain the drive power supply as long as possible
- Stop on ramp
- Fast stop (depends on the inertia and the braking ability of the drive)

■ **Stop mode in the event of a fault**

The type of stop that occurs on detection of a fault is configurable as normal, freewheel or fast for the following faults:

- External fault (detection enabled by a logic input or a bit in a Modbus or CANopen control word)
- Motor phase loss fault

If an output contactor is being used between the drive and the motor, the motor phase loss fault should be disabled.

Variable speed drives Altivar 312

■ Automatic catching of a spinning load with speed detection (“catch on the fly”)

This function is used to restart the motor smoothly after one of the following events, provided the run command is still present:

- Loss of line supply or power off
- Fault reset or automatic restart
- Freewheel stop

On disappearance of the event, the rms speed of the motor is detected in order to restart on a ramp from this speed and return to the reference speed. Speed detection can take up to 1 s depending on the initial deviation.

This function is automatically disabled if the brake sequence is configured.

It is suitable for machines for which the motor speed loss is negligible during the loss of line supply (such as machines with high inertia, fans and pumps driven by a residual flow, etc.).

■ Automatic restart

This function enables the drive to be restarted automatically after it has locked in fault mode, provided the fault has disappeared and the other operating conditions permit a restart.

This restart is performed by a series of automatic attempts separated by increasingly longer waiting periods of 1 s, 5 s, 10 s, then 1 minute for subsequent periods.

The restart procedure can last between 5 minutes and an unlimited time.

If the drive has not restarted after the configured time, it will lock and the procedure is abandoned until it has been powered off and on again.

The faults which permit this type of restart are:

- Line overvoltage
- Motor thermal overload
- Drive thermal overload
- DC bus overvoltage
- Loss of one input phase
- External fault
- Loss of 4-20 mA reference
- CANopen bus fault
- Modbus serial link fault

Line voltage too low. For this fault, the function is always active, even if it is not configured.

For these faults, the relay configured as a fault relay remains activated if the function is configured. The speed reference and direction of operation must be maintained for this function.

This function is suitable for machines or installations which are in continuous operation or are not monitored, and where a restart will not endanger equipment or personnel in any way.

■ Derated operation in the event of an undervoltage

The line voltage monitoring threshold is lowered to 50% of the motor voltage.

In this case, a line choke must be used and the performance of the drive cannot be guaranteed.

■ Fault relay, unlocking

The fault relay is energized when the drive is powered up and is not faulty.

It contains an N/C contact and an N/O contact with common point.

The drive is unlocked after a fault in one of the following ways:

- By powering down until the ON LED goes out, then switching the drive back on
- By assigning a logic input to the External faults function
- By the Automatic restart function, if it has been configured

■ Resetting operating time to zero

The drive operating time can be reset to zero.

Variable speed drives Altivar 312

■ Motor thermal protection

The theoretical temperature rise of the motor is continuously calculated to provide indirect thermal protection.
Thermal protection is adjustable from 0.2 to 1.5 times the nominal drive current.
This function is suitable for all applications with self-cooled motors.

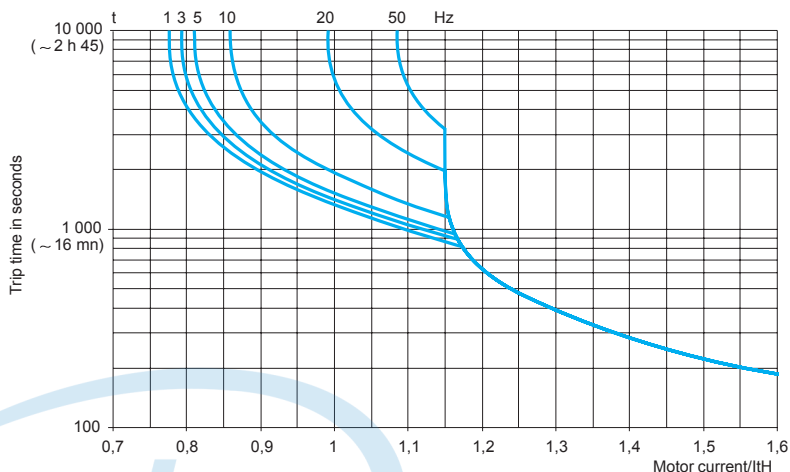

Motor thermal protection curves

■ Drive thermal protection

Thermal protection, by a PTC probe mounted on the heatsink or integrated in the power module, ensures that the drive is protected in the event of poor ventilation or excessive ambient temperatures.
Locks the drive in the event of a fault.

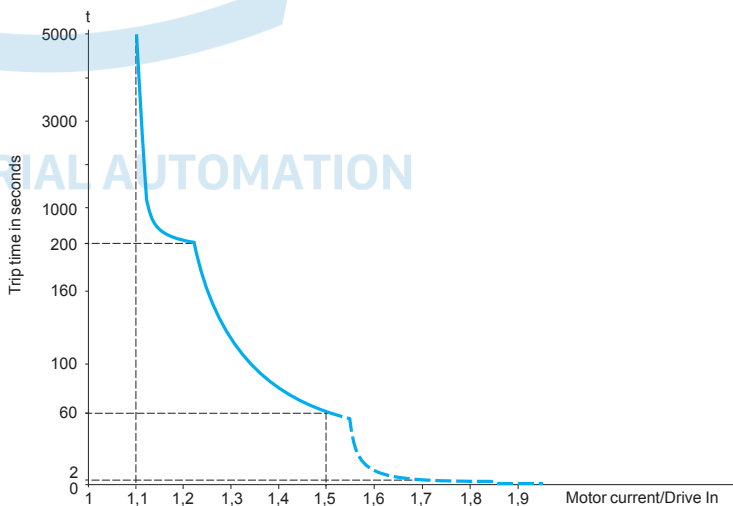

Drive thermal protection curves

■ R1/R2 relay configuration

The following states are signalled when the relay is powered on:

- Drive fault
- Drive running
- Frequency threshold reached
- High speed reached
- Current threshold reached
- Frequency reference reached
- Motor thermal threshold reached
- Brake sequence (R2 only)

■ **AOC/AOV analog outputs**

The same data is available on analog outputs AOC and AOV.

The following assignments are possible:

- Motor current
- Motor frequency
- Motor torque
- Power supplied by the drive
- Drive fault
- Frequency threshold reached
- High speed reached
- Current threshold reached
- Frequency reference reached
- Motor thermal threshold reached
- Brake sequence

Adjusting analog outputs AOC/AOV modifies the characteristics of the current analog output AOC or the voltage analog output AOV.

AOC: can be set as 0-20 mA or 4-20 mA

AOV: can be set as 0-10 V

■ **Saving and retrieving the configuration**

It is possible to save a configuration. This function is used to store a drive configuration in addition to the current configuration.

Retrieving this configuration clears the current configuration.

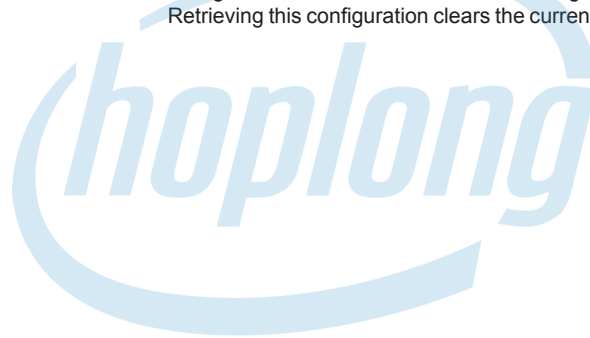

INDUSTRIAL AUTOMATION

Function compatibility table

■ **Configurable I/O**

Functions which are not listed in this table are fully compatible.
 Stop functions have priority over run commands.

The selection of functions is limited by:

- The number of drive I/O
- The incompatibility of certain functions with one another

Functions	Summing inputs	+/- speed	Limit switch management	Preset speeds	PI regulator	Jog operation	Brake sequence	DC injection stop	Fast stop	Freewheel stop
Summing inputs	☐	⊖	⊕	↑	⊖	↑	⊕	⊕	⊕	⊕
+/- speed	⊖	☐	⊕	⊖	⊖	⊖	⊕	⊕	⊕	⊕
Limit switch management	⊕	⊕	☐	⊕	⊖	⊕	⊕	⊕	⊕	⊕
Preset speeds	←	⊖	⊕	☐	⊖	↑	⊕	⊕	⊕	⊕
PI regulator	⊖	⊖	⊖	⊖	☐	⊖	⊖	⊕	⊕	⊕
Jog operation	←	⊖	⊕	←	⊖	⊖	⊖	⊕	⊕	⊕
Brake sequence	⊕	⊕	⊕	⊕	⊖	⊖	☐	⊖	⊕	⊕
DC injection stop	⊕	⊕	⊕	⊕	⊕	⊕	⊖	☐	⊕	↑
Fast stop	⊕	⊕	⊕	⊕	⊕	⊕	⊕	⊕	☐	↑
Freewheel stop	⊕	⊕	⊕	⊕	⊕	⊕	⊕	←	←	☐

⊖ Incompatible functions
 ⊕ Compatible functions
 ☐ Not applicable

Priority functions (functions which cannot be active at the same time)

← The arrow indicates which function has priority
 ↑ Example: the Freewheel stop function has priority over the Fast stop function

CÔNG TY CỔ PHẦN CÔNG NGHỆ HỢP LONG



INDUSTRIAL AUTOMATION

Hotline: 1900.6536 - Website: HOPLONGTECH.COM



INDUSTRIAL AUTOMATION

Schneider Electric Industries SAS

www.schneider-electric.com

Head Office
35, rue Joseph Monier
F-92500 Rueil-Malmaison
France

The information provided in this documentation contains general descriptions and/or technical characteristics of the performance of the products contained herein. This documentation is not intended as a substitute for and is not to be used for determining suitability or reliability of these products for specific user applications. It is the duty of any such user or integrator to perform the appropriate and complete risk analysis, evaluation and testing of the products with respect to the relevant specific application or use thereof. Neither Schneider Electric nor any of its affiliates or subsidiaries shall be responsible or liable for misuse of the information contained herein.

Design: Schneider Electric
Photos: Schneider Electric
Printed by: