

Frame Size 24mm/42mm/60mm/85mm Shaft Type Motor Frame Size 42mm/60mm/85mm Built-in Brake Type Motor

■ Features

- Compact design and light weight with high accuracy, speed and torque
- Suitable for small-sized equipment applications
- Frame size 42mm/60mm/85mm built-in brake of shaft type for compact equipment (AK-B Series)
- Brake force is released (AK-B Series) when applying power on brake wire
- Cost-effective

 Please read "Safety Considerations" in the instruction manual before using.

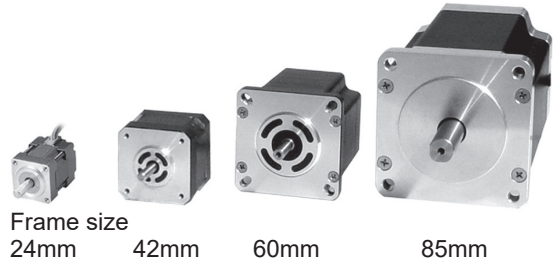

Frame size 24mm 42mm 60mm 85mm

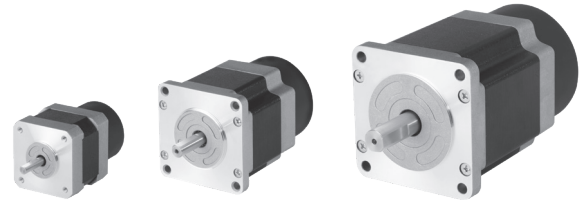

Frame size 42mm Brake built-in type 60mm Brake built-in type 85mm Brake built-in type

■ Dimensions

- ※ These dimensions are for dual shaft models. Single shaft models do not include shafts indicated in the dotted lines.
- ※ For flexible coupling (ERB series) information, refer to 'ERB Series' in 'Rotary encoder'. (frame size 24mm, 48mm, 60mm (shaft type))
- ※ Brake is non-polar and be sure to observe rated excitation voltage (24VDC). (except frame size 24mm)
SW1 ON: brake release / SW1 OFF: brake execute

◎ Frame size 24mm

(unit: mm)

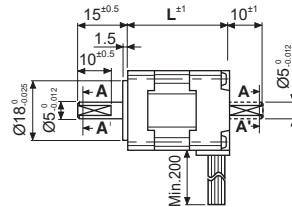
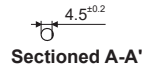
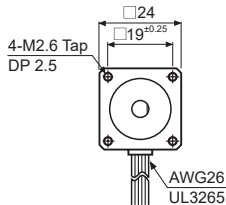

(unit: mm)

Model	L
02K-S523(W)	30.5
04K-S525(W)	46.5

◎ Frame size 42mm

(unit: mm)

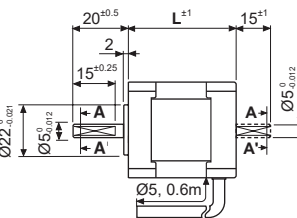
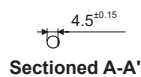
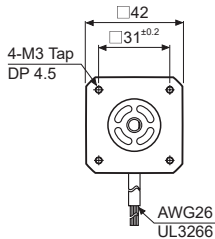

<Standard type>

Model	L
A1K-S543(W)-[B]	33
A2K-[]544(W)-[B]	39
A3K-S545(W)-[B]	47

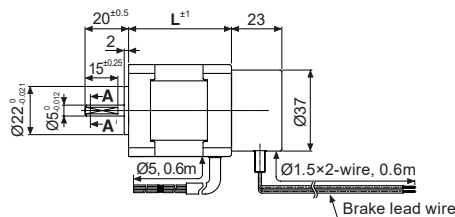
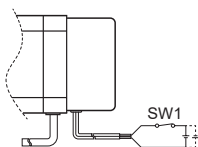

<Built-in brake type>

SENSORS
CONTROLLERS
MOTION DEVICES
SOFTWARE
(Y) Closed Loop Stepper System
(Z) Stepper Motors
(AA) Drivers
(AB) Motion Controllers

AK/AK-B Series

■ Dimensions

◎ Frame size 60mm

(unit: mm)

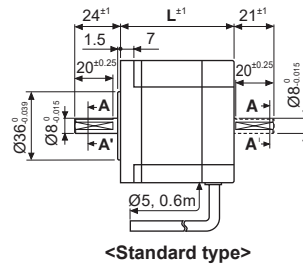
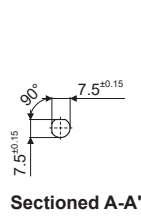
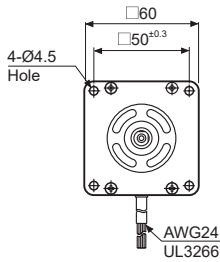

(unit: mm)

Model	L
A4K-□564(W)-□B	48.5
A8K-□566(W)-□B	59.5
A16K-□569(W)-□B	89

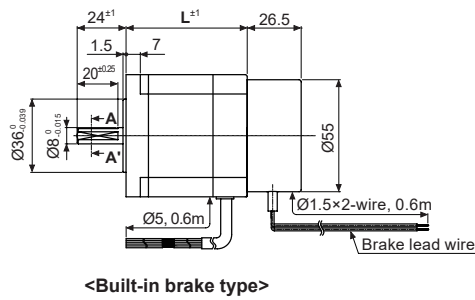
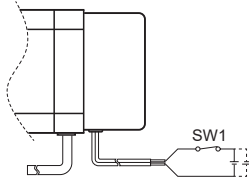

◎ Frame size 85mm

(unit: mm)

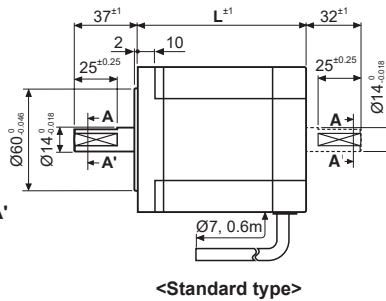
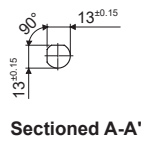
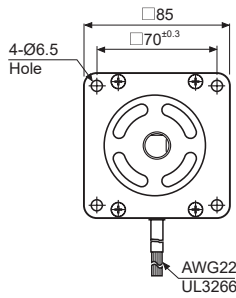

Model	L
A21K-□596(W)-□B	68
A41K-□599(W)-□B	98
A63K-□5913(W)-□B	128

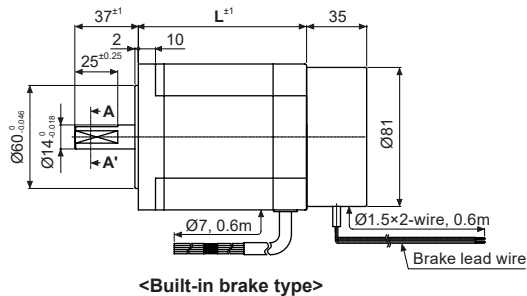
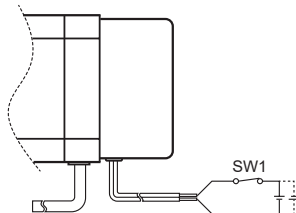

5-Phase Stepper Motor

Characteristic

02K-S523

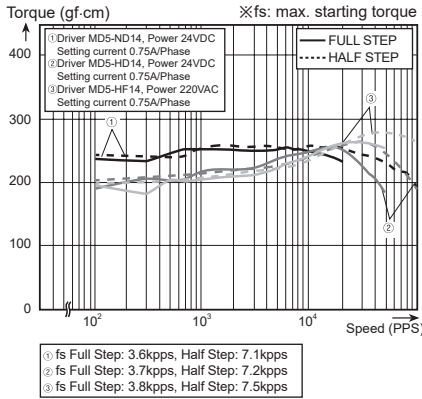

04K-S525

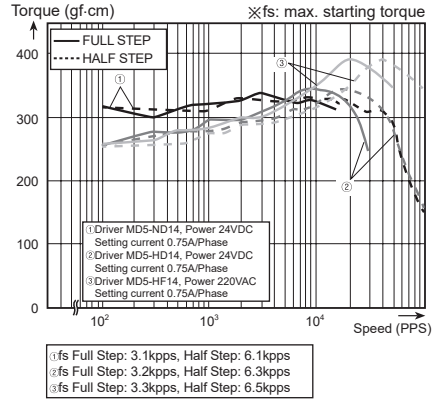

A1K-S543 / A1K-S543-B

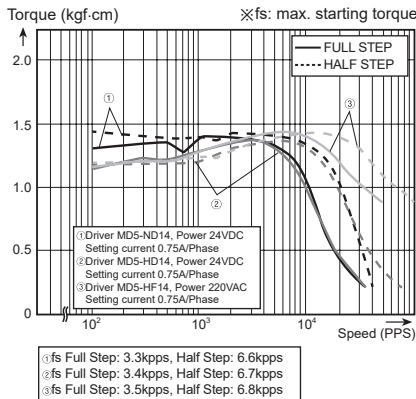

A2K-544 / A2K-544-B

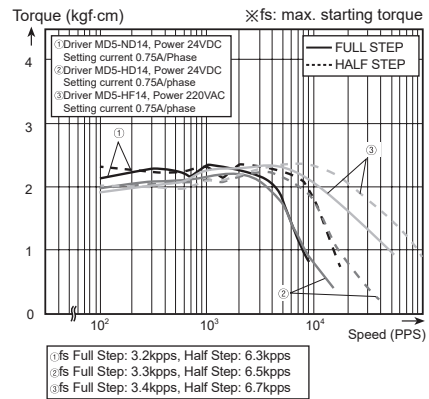

A3K-S545 / A3K-S545-B

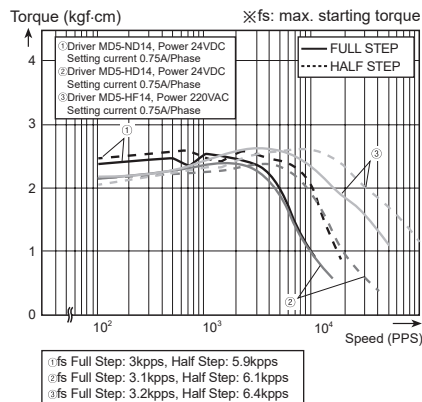

A4K-564 / A4K-M564-B

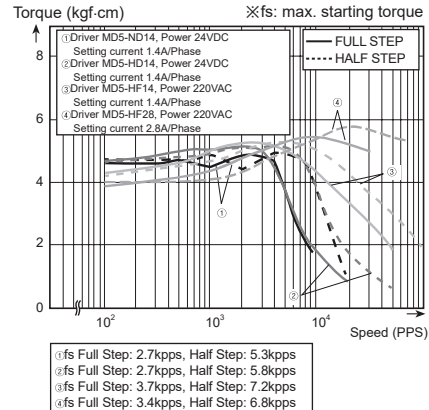

SENSORS
CONTROLLERS
MOTION DEVICES
SOFTWARE
(Y) Closed Loop Stepper System
(Z) Stepper Motors
(AA) Drivers
(AB) Motion Controllers

AK/AK-B Series

■ Characteristic

● A8K-□566 / A8K-M566-B

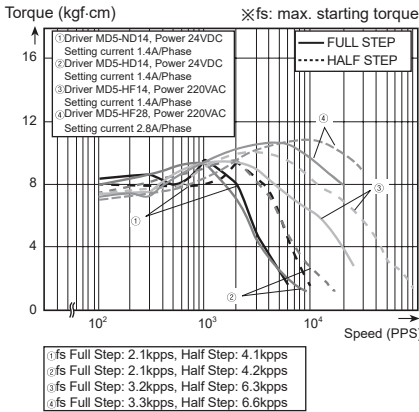

● A16K-□569 / A16K-□569-B

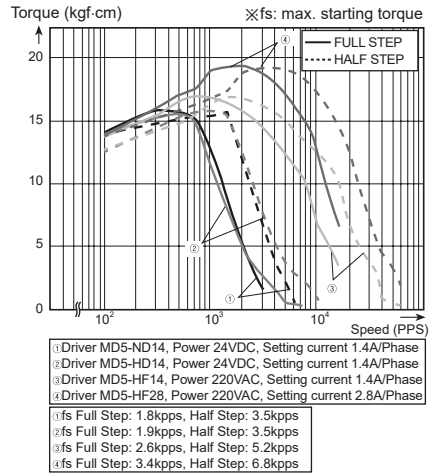

● A21K-□596 / A21K-□596-B

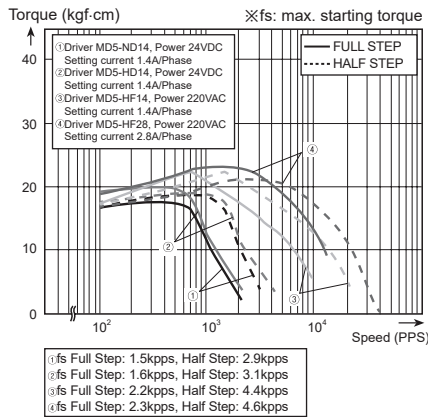

● A41K-□599 / A41K-□599-B

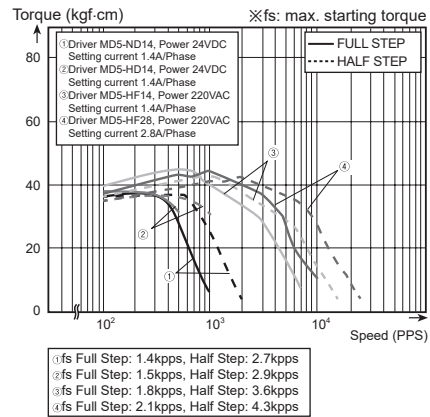

● A63K-□5913 / A63K-□5913-B

