



IEC/EN 60947-2, GB 14048.2, UL1077 (Supplementary Protector TC 3)



CE

The C60H-DC supplementary protectors are used in direct current circuits (Industrial control and automations, transport, renewable energy...). They combine the following functions of circuit protection against short-circuit and overload currents, control and isolation.

### Catalogue numbers

C60H-DC			
Operating voltage (Ue)	12...250 V DC	12...500 V DC	
Rated voltage (Un)	250 V DC	500 V DC	
Number of poles	1P	2P	
Curve	C	C	
Number of modules of 9 mm	2	4	
Diagrams			
Standards	UL1077	IEC 60947-2 EN 60947-2 GB 14048.2	UL1077 IEC 60947-2 EN 60947-2 GB 14048.2
Breaking capacity	5 kA / 250 V DC	20 kA / 110 V DC 10 kA / 220 V DC 6 kA / 250 V DC	5 kA / 500 V DC 20 kA / 220 V DC 10 kA / 440 V DC 6 kA / 500 V DC
Rating (A)*	<b>UL 1077, IEC 60947-2, EN 60947-2, GB 14048.2</b>		
0.5	MGN61500	MGN61520	
1	MGN61501	MGN61521	
2	MGN61502	MGN61522	
3	MGN61503	MGN61523	
4	MGN61504	MGN61524	
5	MGN61505	MGN61525	
6	MGN61506	MGN61526	
10	MGN61508	MGN61528	
13	MGN61509	MGN61529	
15	MGN61510	MGN61530	
16	MGN61511	MGN61531	
20	MGN61512	MGN61532	
25	MGN61513	MGN61533	
30	MGN61514	MGN61534	
32	MGN61515	MGN61535	
40	MGN61517	MGN61537	
Rating (A)*	<b>IEC 60947-2, EN 60947-2, GB 14048.2</b>		
50	MGN61518	MGN61538	
63	MGN61519	MGN61539	

\* At 25°C / 77°F see temperature derating module 92515.

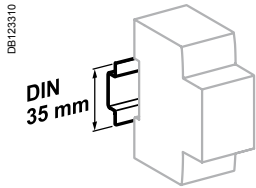

Clip on DIN rail 35 mm.

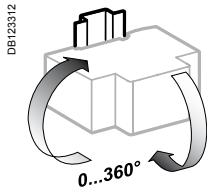

Indifferent position of installation.

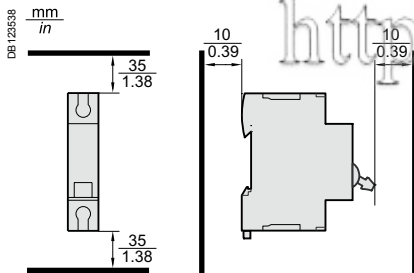
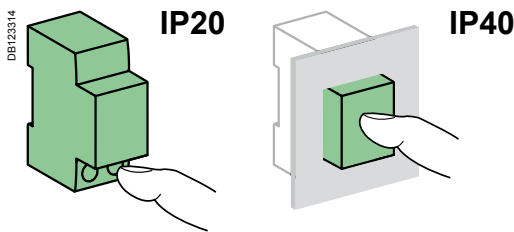

Details of minimum distance between circuit-breaker and earthed metal parts for circuit-breaker intended for use without enclosure.

### Technical data

- Tripping curves: C curve - Overcurrent protection for any type of application.
- Positive break indication - the green strip indicates that all the poles are open and allows work to be carried out on the downstream circuit in complete safety.
- Suitable for isolation as defined in IEC / EN 60947-2.
- Increase in the service life of the product: thanks to fast closure independent of the speed of action on the handle.
- Current limitation in the event of a fault: fast opening of the contacts prevents the loads from being destroyed in the event of a short-circuit.

Main characteristics	
Rated service breaking capacity (Ics)	75 % of the ultimate breaking capacity (Icu)
Power loss	See module 92517
Magnetic tripping (Ii)	8.5 In (± 20 %) (compatible with curve C)
Rated impulse withstand voltage (Uimp) under frame	6 kV
Insulation voltage (Ui)	500 V DC
Endurance (O-C)	
Electrical	3,000 cycles (where L/R=2 ms) 6,000 cycles where the circuit is resistive
Mechanical	20,000 cycles
Additional characteristics	
Pollution degree	3
Utilization category	A (no delay in accordance with IEC/EN 60947-2 standards)
Tropicalization (IEC 60068-2 and GB 14048.2)	Relative humidity: 95 % at 55°C / 131°F
Operating temperature	-25°C to 70°C / -13°F to 158°F
Storage temperature	-40°C to 85°C / -40°F to 185°F



**Failure to match polarity during connection may lead to a fire hazard and/or serious injury.**

- The connection polarity must be observed (marked on the front panel).
- Use only with direct current.
- If two poles are used in series for the American network, use at least a 12 inch / 30 cm cable.

### Weight (g)

Circuit-breaker	
Type	C60H-DC
1P	128 g / 4.51 oz
2P	256 g / 9.03 oz

### Dimensions (mm/in)

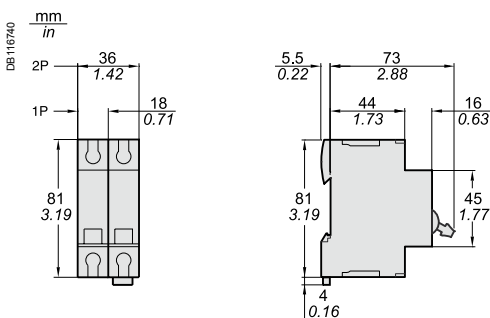



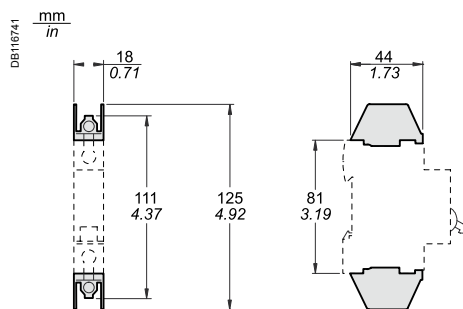



C60H-DC

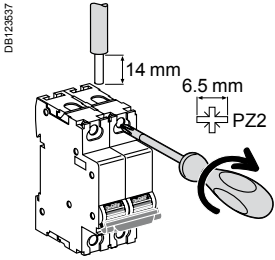

Kit for ring terminals

### Connection



Rating	Tightening torque	Without accessory		With accessories			
		Copper cables		50 mm <sup>2</sup> Al terminal	Screw-on connection for ring terminal	Multi-cables terminal	
		Rigid / Stranded	Flexible or ferrule			Rigid cables	Flexible cables
≤ 25 A	2.5 N.m / 22 lb.in						
> 25 A	3.5 N.m / 31 lb.in	1 to 25 mm <sup>2</sup> #18 - #4 AWG	1 to 16 mm <sup>2</sup> #18 - #6 AWG	50 mm <sup>2</sup> 1 AWG	∅ 5 mm	3 x 16 mm <sup>2</sup> 3 x 6 AWG	3 x 10 mm <sup>2</sup> 3 x 8 AWG
		1 to 35 mm <sup>2</sup> #18 - #2 AWG	1 to 25 mm <sup>2</sup> #18 - #4 AWG	-			

1	Insulated connector	see module 91906
2	Comb busbar	see module 91906
3	Terminal 50 mm <sup>2</sup> Al / Cu	27060
4	Ring tongue terminal screw connection	27053
5	Ring tongue terminal connections kit ∅ 5 mm, (upstream/downstream)	17400
6	Insulated distribution terminal	4 pieces 19091 3 pieces 19096

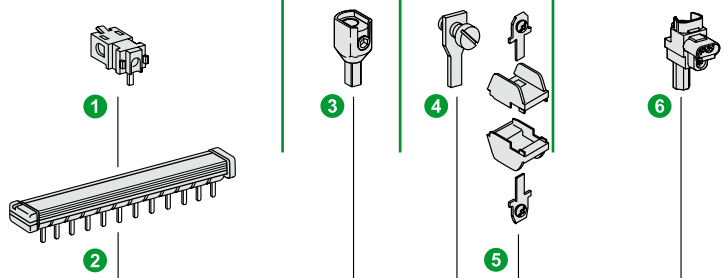

### Mounting accessories

7	Sealable terminal shield	26976
8	Inter-pole barrier	27001
9	Rotary handle	
	Switching sub-assembly	27046
	Disconnectable handle	27047
	Fixed handle	27048
10	Screw shield	26981
11	Padlocking accessory (to be locked in the "open" position)	26970
12	Spacer	27062
13	Dividable mounting plate	26996
14	Marker strip	see module 91900

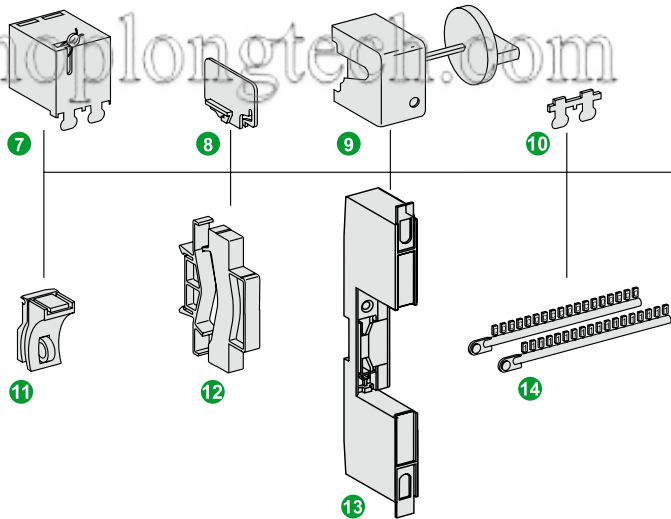

### Electrical auxiliaries

Indication		
15	SD fault indicating switch	see module 90081
16	OF open/closed contact	see module 90081
Tripping		
17	MN undervoltage release	see module 90081
18	MX + OF shunt release	see module 90081

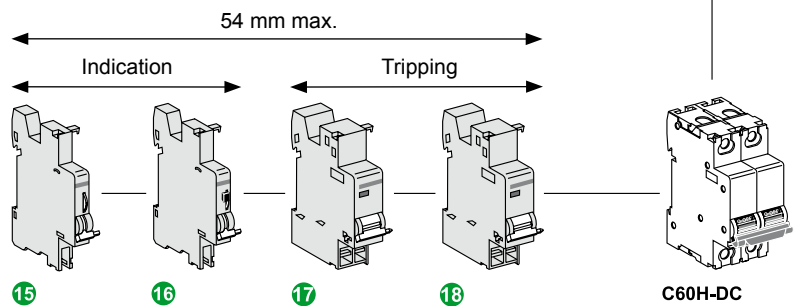

■ The electrical auxiliaries must be installed to the left of the circuit breaker and within a width of 54 mm.  
 ■ If the auxiliary SD contacts are associated with the tripping auxiliaries (MN, MX, etc.), they must be installed to the left of these auxiliaries.

**Poles connected in series**

Network selection			
Type	Earthed		Isolated from earth
Source	Earthed polarity + or -	Earthed central point	Isolated polarities
Protected polarities	1 (1P isolation)	2	2
Diagrams (and type of faults)	<p>DB116851</p> <p><i>Example : negative polarity to the earth</i></p>	<p>DB116852</p>	<p>DB116853</p>

Selection of supplementary protector and pole connection			
24 V ≤ Un ≤ 250 V	Single-pole	Two-pole	Two-pole
Upstream connection	Only if L+ polarity is earthed	<p>DB116735</p>	<p>DB116735</p>
Downstream connection	<p>DB116752</p>	<p>DB116738</p>	<p>DB116738</p>
250 V < Un ≤ 500 V	Two-pole	Two-pole	Two-pole
Upstream connection	<p>DB116736</p>	<p>DB116735</p>	<p>DB116735</p>
Downstream connection	<p>DB116737</p>	<p>DB116738</p>	<p>DB116738</p>

Fault analysis (low earth connection resistance)			
<b>Fault A</b>	<ul style="list-style-type: none"> <li>Isc maximum at U</li> <li>Only protected polarity concerned</li> <li>All the poles of the protected polarity must have a breaking capacity ≥ Isc max. at U</li> </ul>	<ul style="list-style-type: none"> <li>Isc maximum at U/2</li> <li>Only positive polarity concerned</li> <li>All the positive polarity poles must have a breaking capacity ≥ Isc max. at U/2</li> </ul>	<ul style="list-style-type: none"> <li>Not relevant</li> <li>The fault must be indicated by a permanent insulation monitor (PIM) and cleared (IEC/EN 60364)</li> </ul>
<b>Fault B</b>	<ul style="list-style-type: none"> <li>Isc maximum at U</li> <li>If one polarity (in this case positive) is protected: all the poles of this polarity must have a breaking capacity ≥ Isc max. at U</li> <li>If two polarities are protected, to ensure isolation: all the protections of the two polarities must have a breaking capacity ≥ Isc max. at U</li> </ul>	<ul style="list-style-type: none"> <li>Isc maximum at U</li> <li>The 2 polarities are concerned</li> <li>All the poles of the two polarities must have a breaking capacity ≥ Isc max. at U</li> </ul>	<ul style="list-style-type: none"> <li>Isc maximum at U</li> <li>The 2 polarities are concerned</li> <li>All the poles of the two polarities must have a breaking capacity ≥ Isc max. at U</li> </ul>
<b>Fault C</b>		<ul style="list-style-type: none"> <li>As for fault A</li> <li>All the negative polarity poles must have a breaking capacity ≥ Isc max. at U/2</li> </ul>	<ul style="list-style-type: none"> <li>As for fault A with the same requirements</li> </ul>

### Curves

#### Tripping curves

##### C curve as in standard IEC 60947.2

- The operating range of the magnetic release is as follows between  $7 I_n$  and  $10 I_n$ .
- The curves show the cold thermal tripping limits when poles are charged and the electromagnetic tripping limits with 2 charged poles.
- The curves are used without any derating.

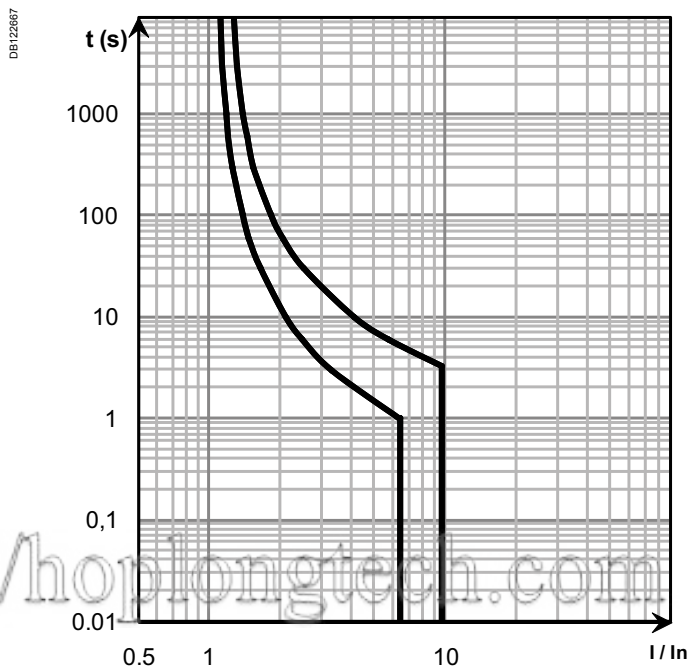

#### Short circuit current limiting

220 V with 1P, 440 V with 2P

250 V with 1P, 500 V with 2P

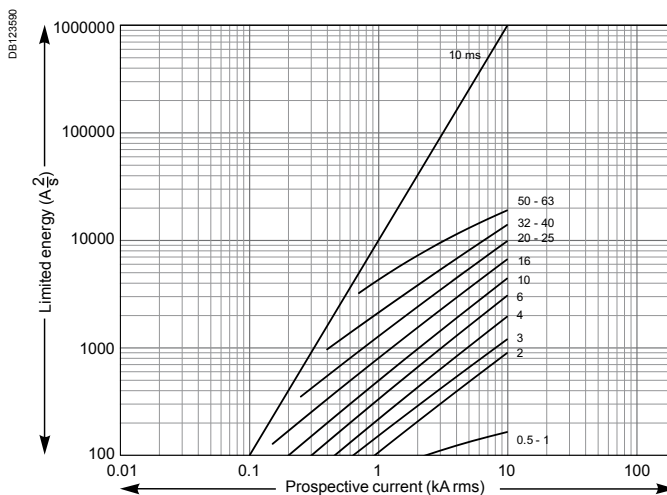
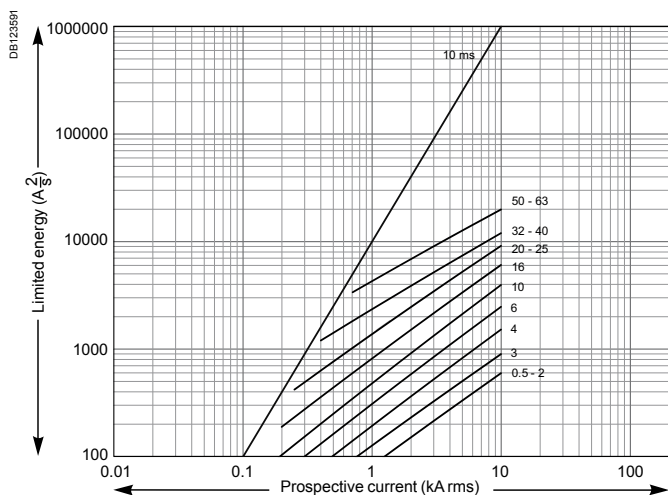

### Curves (cont.)

#### Thermal stress limitation curve

220 V with 1P, 440 V with 2P

250 V with 1P, 500 V with 2P

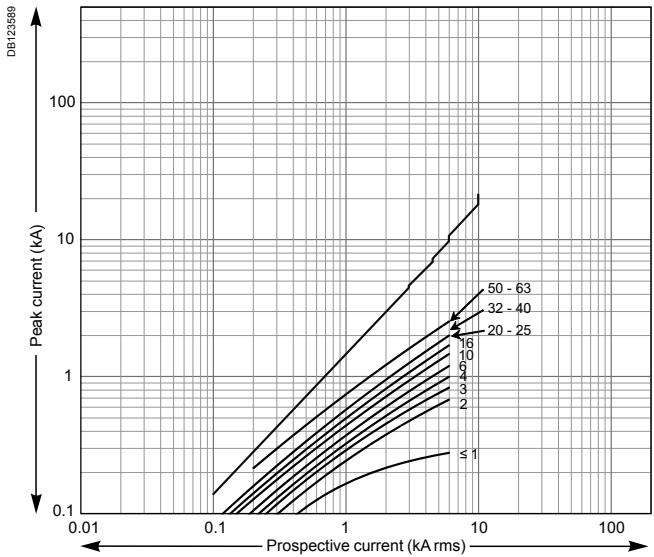
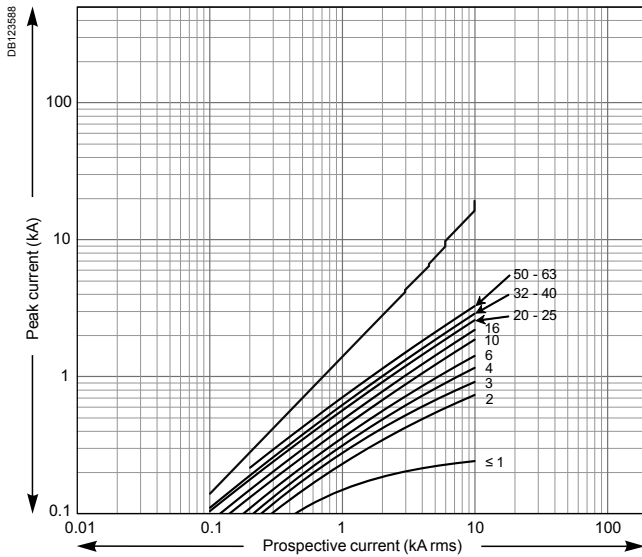

#### Temperature derating (according to UL 1077/ CSA22.2/ UL489A/ UL489/ IEC 60947-2 standards)

The maximum permissible current in a device depends on the ambient temperature in which it is placed. Ambient temperature is the temperature inside the enclosure or switchboard in which the devices have been installed.

The reference temperature is in the coloured column.



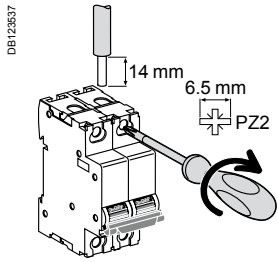

When several simultaneously operating devices are mounted side by side in a small enclosure, the temperature rise inside the enclosure causes a reduction in the current rating. A reduction coefficient of the order of 0.8 must therefore be allocated to the rating (already derated if it depends on the ambient temperature).

Temperature (°C)	-30	-25	-20	-15	-10	-5	0	5	10	15	20	25	30	35	40	45	50	55	60	65	70	
<b>Ratings (A)</b>																						
0.5	0.63	0.62	0.61	0.60	0.59	0.58	0.56	0.55	0.54	0.53	0.51	0.5	0.49	0.47	0.46	0.44	0.43	0.41	0.39	0.38	0.36	
1	1.18	1.17	1.15	1.14	1.12	1.10	1.09	1.07	1.05	1.04	1.02	1	0.98	0.96	0.94	0.92	0.90	0.88	0.86	0.84	0.82	
1.2	1.45	1.43	1.41	1.39	1.37	1.34	1.32	1.30	1.27	1.25	1.22	1.2	1.17	1.15	1.12	1.09	1.07	1.04	1.01	0.98	0.95	
1.5	1.86	1.83	1.80	1.77	1.74	1.71	1.67	1.64	1.61	1.57	1.54	1.5	1.46	1.42	1.39	1.34	1.30	1.26	1.22	1.17	1.12	
2	2.54	2.50	2.45	2.41	2.36	2.31	2.26	2.21	2.16	2.11	2.06	2	1.94	1.88	1.82	1.76	1.70	1.63	1.56	1.48	1.41	
3	3.78	3.71	3.65	3.58	3.51	3.45	3.38	3.30	3.23	3.16	3.08	3	2.92	2.84	2.75	2.66	2.57	2.48	2.38	2.27	2.17	
4	5.08	4.99	4.90	4.81	4.71	4.62	4.52	4.42	4.32	4.22	4.11	4	3.89	3.77	3.65	3.53	3.40	3.27	3.13	2.98	2.83	
5	6.00	5.92	5.83	5.74	5.66	5.57	5.48	5.39	5.29	5.20	5.10	5	4.90	4.80	4.69	4.58	4.47	4.36	4.24	4.12	4.00	
6	7.26	7.15	7.04	6.94	6.83	6.71	6.60	6.48	6.37	6.25	6.12	6	5.87	5.74	5.61	5.47	5.33	5.19	5.04	4.89	4.73	
7	8.76	8.62	8.47	8.32	8.17	8.01	7.85	7.69	7.52	7.35	7.18	7	6.82	6.63	6.44	6.24	6.03	5.82	5.60	5.37	5.13	
8	9.64	9.50	9.36	9.22	9.08	8.93	8.78	8.63	8.48	8.32	8.16	8	7.83	7.67	7.49	7.31	7.13	6.95	6.76	6.56	6.36	
10	12.59	12.38	12.16	11.94	11.71	11.49	11.25	11.01	10.77	10.52	10.26	10	9.73	9.45	9.17	8.87	8.57	8.25	7.92	7.58	7.22	
13	15.49	15.28	15.07	14.85	14.63	14.41	14.19	13.96	13.72	13.49	13.25	13	12.75	12.49	12.23	11.97	11.69	11.41	11.13	10.83	10.53	
15	18.61	18.31	18.01	17.70	17.38	17.06	16.74	16.40	16.07	15.72	15.36	15	14.63	14.25	13.85	13.45	13.03	12.60	12.16	11.69	11.21	
16	19.43	19.14	18.85	18.55	18.25	17.95	17.64	17.32	17.00	16.68	16.34	16	15.65	15.29	14.93	14.56	14.17	13.78	13.37	12.95	12.52	
20	24.06	23.72	23.37	23.02	22.67	22.31	21.94	21.56	21.18	20.80	20.40	20	19.59	19.17	18.74	18.30	17.85	17.39	16.92	16.43	15.93	
25	30.35	29.91	29.45	28.99	28.52	28.05	27.56	27.07	26.57	26.06	25.53	25	24.46	23.90	23.33	22.74	22.14	21.53	20.89	20.24	19.56	
30	37.35	36.74	36.12	35.50	34.86	34.21	33.54	32.86	32.17	31.46	30.74	30	29.24	28.46	27.66	26.83	25.98	25.10	24.19	23.24	22.25	
32	38.45	37.91	37.36	36.80	36.24	35.66	35.08	34.48	33.88	33.27	32.64	32	31.35	30.68	30.00	29.31	28.59	27.86	27.11	26.34	25.54	
35	44.15	43.40	42.63	41.86	41.06	40.25	39.42	38.58	37.72	36.83	35.93	35	34.05	33.06	32.05	31.01	29.93	28.81	27.64	26.42	25.14	
40	48.92	48.17	47.42	46.65	45.87	45.08	44.28	43.45	42.62	41.76	40.89	40	39.09	38.16	37.20	36.22	35.21	34.17	33.10	31.99	30.84	
50	59.93	59.09	58.25	57.39	56.52	55.63	54.74	53.82	52.89	51.95	50.98	50	49.00	47.97	46.93	45.86	44.77	43.64	42.49	41.31	40.09	
60	76.16	74.83	73.48	72.11	70.71	69.28	67.82	66.33	64.81	63.25	61.64	60	58.31	56.57	54.77	52.92	50.99	48.99	46.90	44.72	42.43	
63	78.16	76.91	75.63	74.33	73.01	71.67	70.30	68.90	67.47	66.02	64.53	63	61.44	59.83	58.18	56.49	54.74	52.93	51.06	49.12	47.10	

### Multi-cables connection



### Without accessory

Rating	Tightening torque	2 Copper cables		3 Multi-cables / Different wires	
		Rigid / Stranded	Flexible or ferrule	Flexible / Stranded	Flexible / Stranded / Rigid
		DB123945 	DB123946 	DB118787 	
≤ 25 A	2.5 N.m / 22 lb.in	2 x 1 mm <sup>2</sup> to 2 x 10 mm <sup>2</sup> 2 x 18 AWG - 2 x 8 AWG		3 x 1 mm <sup>2</sup> 3 x 18 AWG	2 x 2.5 mm <sup>2</sup> + 1 x 1.5 mm <sup>2</sup> 2 x 13 AWG + 1 x 15 AWG
> 25 A	3.5 N.m / 31 lb.in	2 x 1 mm <sup>2</sup> to 2 x 16 mm <sup>2</sup> 2 x 18 AWG - 2 x 6 AWG		3 x 4 mm <sup>2</sup> 3 x 6 AWG	2 x 10 mm <sup>2</sup> + 1 x 6 mm <sup>2</sup> 2 x 8 AWG + 1 x 9 AWG

<https://hoplongtech.com>