

ø30 series Switches & Pilot Lights

**Heavy duty switches & pilot lights offer both variety and reliability
Endures harsh environments**

- Degree of protection: IP65
- UL, CSA approved, and EN compliant.

Applicable Standards	Mark	File No. or Organization
UL 508		UL Listing File No. E68961
CSA C22.2 No.14		CSA File No. LR21451
EN60947-5-1		EU Low Voltage Directive
GB14048.5		CCC No. 200501030514658



Specifications and Ratings

Contact Ratings

Pushbuttons Illuminated Pushbuttons Selector Switches Illuminated Selector Switches Selector Pushbuttons	Contact Block	BS/BST (ø30 series)
	Rated Insulation Voltage	600V
	Rated Continuous Current	10A
	Contact Ratings by Utilization Category IEC 60947-5-1	AC-15 (A600) DC-13 (P600)

Characteristics

Contact Ratings by Utilization Category

Operational Voltage			24V	48V	50V	110V	220V	440V
Operational Current	AC 50/60 Hz	AC-12 Control of resistive loads and solid state loads	10A	—	10A	10A	6A	2A
		AC-15 Control of electromagnetic loads (> 72 VA)	10A	—	7A	5A	3A	1A
	DC	DC-12 Control of resistive loads and solid state loads	10A	5A	—	2.2A	1.1A	—
		DC-13 Control of electromagnets	5A	2A	—	1.1A	0.6A	—

Note: The operational current represents the classification by making and breaking currents (IEC 60947-5-1).
Minimum applicable load: 3V AC/DC, 5 mA (applicable range may vary with operating conditions and load types)
For mono-levers and cam switches, see pages 55 and 58.

BS (BST) Contact Block

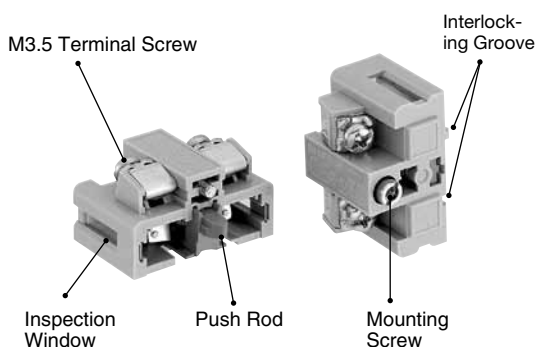

Contact Blocks

Contact		Single-pole Contact Block			
Part No.	BS	BS010E	BS001E	BS010SE	BS001SE
	BST	BST010	BST001	BST010S	BST001S
Push Rod		Green	Red	Black	White

BST contact blocks are used for the following switches and are not interchangeable with BS contact blocks.
(The BS housing is dark gray and the BST housing is light gray.)

- Pushlock turn reset and push turn lock switches
- LED illuminated pushbuttons
- LED/incandescent illuminated selector switches
- All models of diecast zinc housing switches & pilot lights

- Durable nylon 66 housing has a high resistance against alkalis.
- Silver contacts. Gold contact (gold-plated silver) also available.
- Up to four blocks in two layers can be mounted onto each operator.

ø30 Series Switches & Pilot Lights ø30

LED Illuminated Unit Specifications

Unit	Color Code ②	Input	Operating Voltage	LED Lamp		
				Lamp Base	Part No.	Voltage
Pilot Light Illuminated Pushbutton Illuminated Selector Switch	A: amber G: green PW: pure white R: red S: blue W: white Y: yellow	Full Voltage	6V AC/DC	BA9S/13	LSTD-6 ②	6V AC/DC ±10%
			12V AC/DC		LSTD-1 ②	12V AC/DC ±10%
			24V AC/DC		LSTD-2 ②	24V AC/DC ±10%
			6V AC/DC	E12/15	LETD-6 ②	6V AC/DC ±10%
			12V AC/DC		LETD-8 ②	12V AC/DC ±10%
			24V AC/DC		LETD-2 ②	24V AC/DC ±10%
		Transformer	100/110V AC 120V AC 200/220V AC 240V AC 380V AC 400/440V AC (50/60 Hz)	BA9S/13	LSTD-6 ②	6V AC/DC ±10%
				E12/15	LETD-6 ②	
		DC-DC Converter	110V DC	BA9S/13	LSTD-6 ②	6V AC/DC ±10%
				E12/15	LETD-6 ②	

Note: A pure white LED lamp is used for yellow illumination.

Incandescent Illuminated Unit Specifications

Unit	Color Code ②	Input	Operating Voltage	Incandescent Lamp		
				Lamp Base	Part No.	Rating
Pilot Light Illuminated Pushbutton Illuminated Selector Switch	A: amber G: green O: orange R: red S: blue W: white	Full Voltage	6V AC/DC	BA9S/13	LS-6	1W (6.3V)
			12V AC/DC		LS-8	1W (18V)
			24V AC/DC		LS-3	1W (30V)
			6V AC/DC	E12/15	LE-6	2W (6.3V)
			12V AC/DC		LE-8	2W (18V)
			24V AC/DC		LE-3	12W (30V)
		Transformer	100/110V AC 120V AC 200/220V AC 240V AC 380V AC 400/440V AC 480V AC (50/60 Hz)	BA9S/13	LS-6	1W (6.3V)
				E12/15	LE-8	2W (18V)

LED Lamp Ratings (LSTD)

Part No.	LSTD-6②	LSTD-1②	LSTD-2②
Lamp Base	BA9S/13		
Rated Voltage	6V AC/DC	12V AC/DC	24V AC/DC
Voltage Range	6V AC/DC ±10%	12V AC/DC ±10%	24V AC/DC ±10%
Current Draw	AC	8 mA	11 mA
	DC	A, R, W: 7 mA G, PW, S: 5.5 mA	10 mA
Color Code ②	A (amber), G (green), PW (pure white), R (red), S (blue), W (white)		
Lamp Base Color	Same as illumination color		
Voltage Marking	Die stamped on the base		
Life (reference value)	Approx. 50,000 hours (The luminance is reduced to 50% the initial intensity when used on complete DC.)		
Internal Circuit	<p style="text-align: right;"> LED Chip Protection Diode Zener Diode Resistor </p>		

ø30 ø30 series Switches & Pilot Lights

LED Lamp Ratings (LETD)

Part No.	LETD-6②		LETD-8②	LETD-2②
Lamp Base	E12/15			
Rated Voltage	6V AC/DC		12V AC/DC	24V AC/DC
Voltage Range	6V AC/DC ±10%		12V AC/DC ±10%	24V AC/DC ±10%
Current Draw	A, R, W, Y		A, R, W, Y	G, S
	AC	17 mA	8 mA	7 mA
DC	14 mA	5.5 mA	6.5 mA	10 mA
Color Code ②	A (amber), G (green), R (red), S (blue), W (white), Y (yellow)			
Lamp Base Color	Same as illumination color			
Voltage Marking	Die stamped on the base			
Life (reference value)	Approx. 50,000 hours (The luminance is reduced to 50% the initial intensity when used on complete DC.)			
Internal Circuit	A, R, W	Y	A, R, W	Y
	<p style="text-align: center;">G, S</p> <ul style="list-style-type: none"> LED Chip Protection Diode Zener Diode Resistor 			

Incandescent Lamp Ratings (LS)

Part No.	LS-6	LS-8	LS-2	LS-3
Lamp Base	BA9S/13			
Rated Voltage	6V AC/DC	12V AC/DC	18V AC/DC	24V AC/DC
Wattage	1W (6.3V)	1W (18V)	1W (24V)	1W (30V)
Voltage Marking	Die stamped on the base			
Life (reference value)	Approx. 1,000 hours minimum (mean value when used on the rated voltage)			

Incandescent Lamp Ratings (LE)

Part No.	LE-6	LE-8	LE-2	LE-3
Lamp Base	E12/15			
Rated Voltage	6V AC/DC	12V AC/DC	18V AC/DC	24V AC/DC
Wattage	2W (6.3V)	2W (18V)	2W (24V)	2W (30V)
Voltage Marking	Die stamped on the base			
Life (reference value)	Approx. 1,000 hours minimum (mean value when used on the rated voltage)			

ø30 Series Switches & Pilot Lights ø30

Specifications

Operating Temperature	-25 to +50°C (no freezing)	
Storage Temperature	-40 to +80°C (no freezing)	
Operating Humidity	45 to 85% RH (no condensation)	
Contact Resistance	50 mΩ maximum (initial value)	
Insulation Resistance	100 MΩ minimum (500V DC megger)	
Dielectric Strength	Between live and dead metal parts: 2,500V AC, 1 minute (Full voltage and pilot lights: 2,000V AC, 1 minute)	
Vibration Resistance	Operating extremes: 5 to 55 Hz, amplitude 0.5 mm	
Shock Resistance	Damage limits: 1,000 m/s ² Operating extremes: 100 m/s ²	
Mechanical Life (minimum operations)	Pushbuttons Momentary: 5,000,000 Maintained: 500,000 Illuminated pushbuttons Momentary: 2,500,000 Maintained: 500,000 Selector switches: 500,000 Key selector switches: 500,000 Illuminated selector switches: 500,000 Selector pushbuttons: 250,000 Mono-lever switches: 500,000 (Interlocking): 250,000 Pushlock turn reset: 500,000 Mushroom push-pull switch Two contact blocks: 500,000 Four contact blocks: 200,000	
Electrical Life (minimum operations)	Pushbuttons: 500,000 *1 Illuminated pushbuttons: 500,000 *1 Selector switches: 500,000 *2 Key selector switches: 500,000 *2 Illuminated selector switches: 500,000 *2 Selector pushbuttons: 250,000 *2 Mono-lever switches: 500,000 *3 (Interlocking): 250,000 *3 *1 Switching frequency 1,800 operations/h, duty ratio 40% *2 Switching frequency 1,200 operations/h, duty ratio 40% *3 Switching frequency 900 operations/h, duty ratio 40% *4 Switching frequency 900 operations/h for square twin or twin main- tained	

Degree of Protection

Part No.	Unit	NEMA ICS 6-110	IEC 60529
A****	Pushbuttons, pilot lights, illuminated pushbuttons, selector switches, selector pushbuttons, mono-lever switches, and cam switches (ACSNO/ACSSO)	Type 1, 2, 3, 3R, (3S), 4, 5, 12,13	IP65
	Illuminated selector switches, key pushbuttons, key reset pushbuttons, key cam switches, and key selector switches	Type 1, 2, 3, 3R, 5, 12, 13	IP54
U****	Square pushbuttons, square pilot lights, and cam switches (UC)	Type 1, 2	IP40

Note: (3S) of NEMA ICS 6-110 applies to the pilot lights with round lens.

Mounting Hole Layout

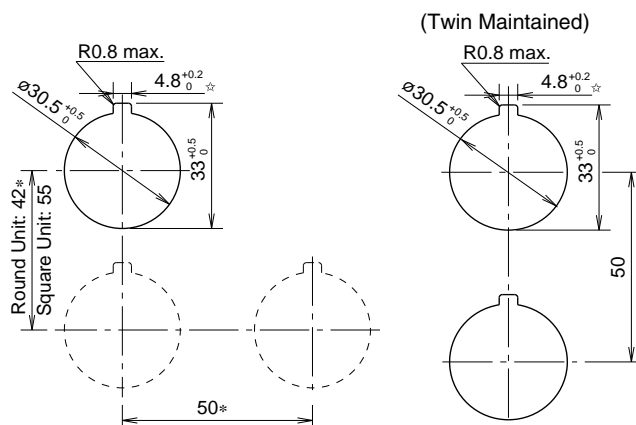

*The minimum mounting centers are applicable to switches with one layer of contact blocks (two contact blocks). When two layers of contact blocks (four contact blocks) are mounted, determine the minimum mounting centers in consideration of convenience for wiring.

- Mushroom with shroud: 50 mm minimum
- Jumbo mushroom: 67 mm minimum
- Jumbo mushroom with shroud: 76 mm minimum
- Square twin: 55 mm minimum
- Selector switch with lever: 50 mm minimum

☆ The 4.8 mm recess is for preventing rotation and is not necessary when the nameplate or anti-rotation ring is not used.

Note: For mounting hole layout of pushbuttons, mono-lever switches, and cam switches, see each section.

ø30 ø30 Series Switches & Pilot Lights (Ordering Information)

Ordering Information

Standard Units

- Specify an operator or lens color code in the Part No.
- Black, green, and red buttons are included with flush push-buttons.
- Terminal covers, nameplates, and accessories are ordered separately.

Terminal Cover

- When a terminal cover is required, order an applicable terminal cover referring to page 67.

The Part No. development charts shown below can be used to specify switches and pilot lights other than those listed on the following pages. Gold-plated silver contacts are also available.

ø30 Series Pushbuttons

ABN2 11 R - MAU

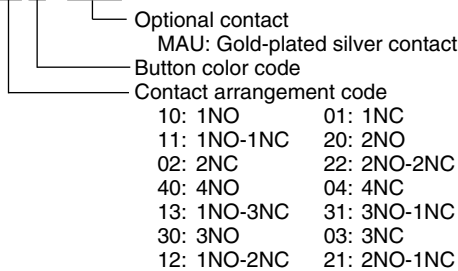

Note:

- Mushroom pull ATN23 can have a maximum of two contact blocks.
- Mushroom push-pull return ATN22 cannot have only NO or only NC contacts.
- No other contact configurations are available for square twin UWQN1 than those specified in this catalog.

ø30 Series Illuminated Pushbuttons

ALFN2 126 13 D N R - MAU

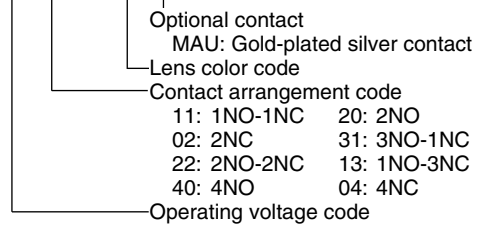

Note:

- Illuminated pushbuttons cannot have an odd number of contact blocks, such as 1NO, 1NC, 3NO, 2NO-1NC, 1NO-2NC, and 3NC.

ø30 Series Pilot Lights

APN1 116 D R

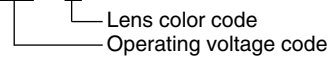

Note:

- LED lamps cannot be used on 480V AC transformers.

ø30 Series Switches & Pilot Lights (Ordering Information) ø30

ø30 Series Selector Switch

ASN 2 L 11 - MAU

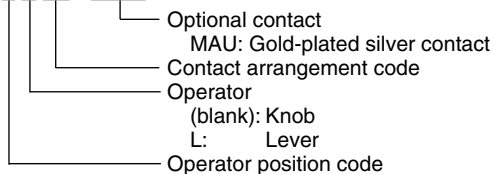

ø30 Series Illuminated Selector Switch

ASLN 2 16 22 D N R - MAU

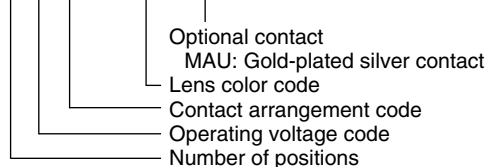

ø30 Series Key Selector Switch

ASN 2 K 11 D - MAU

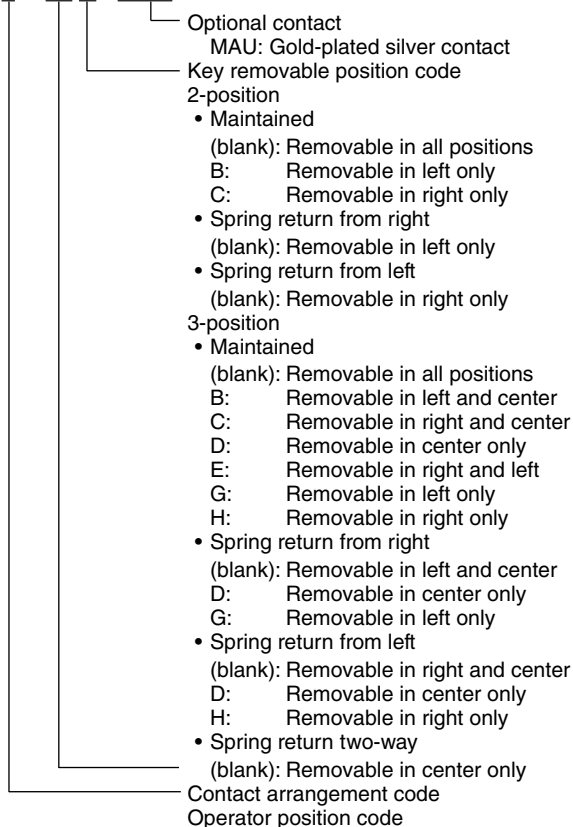













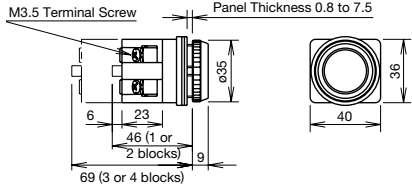

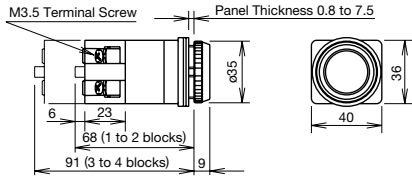

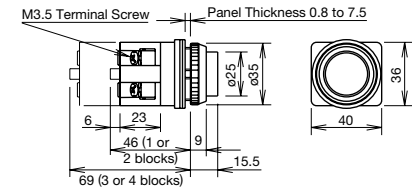
Note:

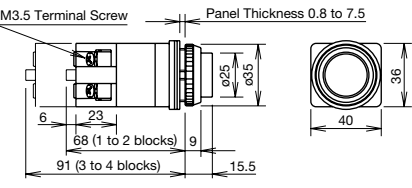
- The key cannot be removed in the return position.

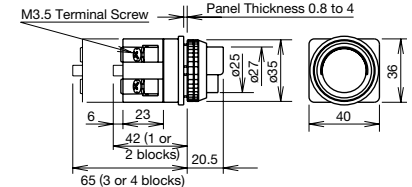
ø30 ø30 Series Pushbuttons

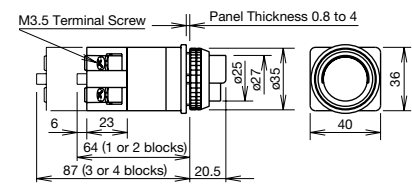
Flush / Extended / Extended w/Half Shroud / Extended w/Full Shroud Pushbuttons

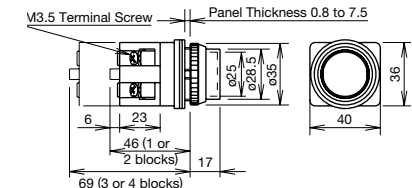
Package Quantity: 1

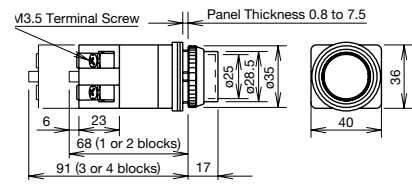









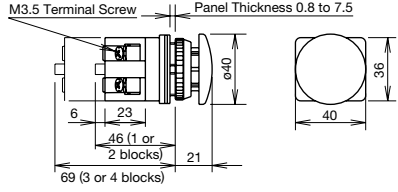

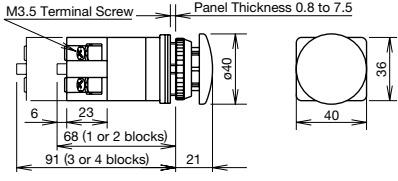

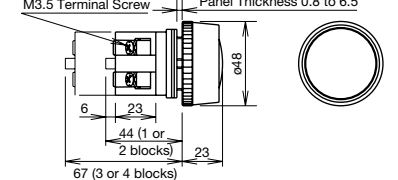
Shape	Operation	Contact	Part No.	① Button Color Code	Dimensions (mm)
Flush ABN1  (nameplate sold separately) 	Momentary	1NO	ABN110 ①	Black (B), green (G), and red (R) buttons are supplied with each unit.	
		1NC	ABN101 ①		
		1NO-1NC	ABN111 ①		
		2NO	ABN120 ①		
		2NC	ABN102 ①		
Flush AON1  (nameplate sold separately) 	Maintained	1NO	AON110 ①	Specify S, W, or Y when a blue, white, or yellow button is required.	
		1NC	AON101 ①		
		1NO-1NC	AON111 ①		
		2NO	AON120 ①		
		2NC	AON102 ①		
Extended ABN2  (nameplate sold separately) 	Momentary	1NO	ABN210 ①		
		1NC	ABN201 ①		
		1NO-1NC	ABN211 ①		
		2NO	ABN220 ①		
		2NC	ABN202 ①		
Extended AON2  (nameplate sold separately) 	Maintained	1NO	AON210 ①		
		1NC	AON201 ①		
		1NO-1NC	AON211 ①		
		2NO	AON220 ①		
		2NC	AON202 ①		
Extended with Half Shroud ABN2G  (nameplate sold separately) 	Momentary	1NO	ABN2G10 ①	Specify a button color code in place of ① in the Part No.	
		1NC	ABN2G01 ①		
		1NO-1NC	ABN2G11 ①		
		2NO	ABN2G20 ①		
		2NC	ABN2G02 ①		
Extended with Half Shroud AON2G  (nameplate sold separately) 	Maintained	1NO	AON2G10 ①	B: black G: green R: red S: blue W: white Y: yellow	
		1NC	AON2G01 ①		
		1NO-1NC	AON2G11 ①		
		2NO	AON2G20 ①		
		2NC	AON2G02 ①		
Extended with Full Shroud ABN2F  (nameplate sold separately) 	Momentary	1NO	ABN2F10 ①		
		1NC	ABN2F01 ①		
		1NO-1NC	ABN2F11 ①		
		2NO	ABN2F20 ①		
		2NC	ABN2F02 ①		
Extended with Full Shroud AON2F  (nameplate sold separately) 	Maintained	1NO	AON2F10 ①		
		1NC	AON2F01 ①		
		1NO-1NC	AON2F11 ①		
		2NO	AON2F20 ①		
		2NC	AON2F02 ①		

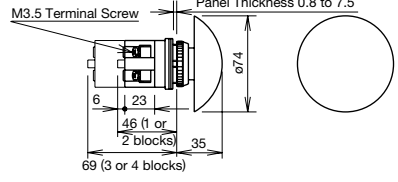
- Round bezel and shroud (metal): Chrome-plated
- Other contact arrangements and gold-plated silver contacts are also available. See page 20.

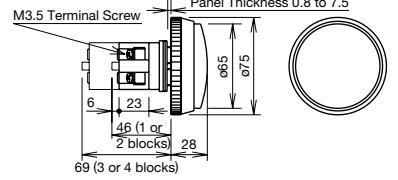
ø30 Series Pushbuttons ø30

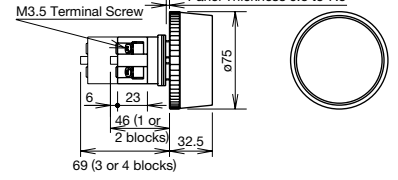
Mushroom / Jumbo Mushroom / Square Flush / Square Extended Pushbuttons

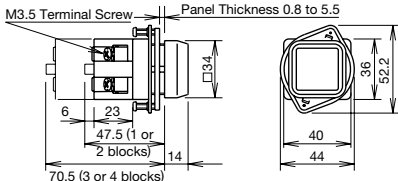
Package Quantity: 1

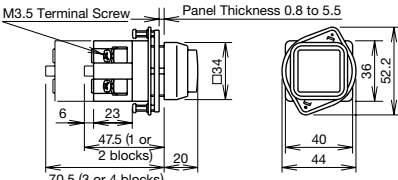









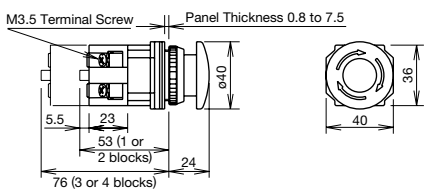

Shape	Operation	Contact	Part No.	① Button Color Code	Dimensions (mm)	
Mushroom ABN3  (nameplate sold separately)	Momentary	1NO	ABN310 ①	B: black G: green R: red S: blue W: white Y: yellow		
		1NC	ABN301 ①			
		1NO-1NC	ABN311 ①			
		2NO	ABN320 ①			
		2NC	ABN302 ①			
		2NO-2NC	ABN322 ①			
Mushroom AON3  (nameplate sold separately)	Maintained	1NO	AON310 ①		B: black G: green R: red S: blue W: white Y: yellow	
		1NC	AON301 ①			
		1NO-1NC	AON311 ①			
		2NO	AON320 ①			
		2NC	AON302 ①			
		2NO-2NC	AON322 ①			
Mushroom with Full Shroud ABN3G  (nameplate sold separately)	Momentary	1NO	ABN3G10 ①	B: black G: green R: red S: blue W: white Y: yellow		
		1NC	ABN3G01 ①			
		1NO-1NC	ABN3G11 ①			
		2NO	ABN3G20 ①			
		2NC	ABN3G02 ①			
		2NO-2NC	ABN3G22 ①			
Palm Mushroom ABN4  (nameplate sold separately)	Momentary	1NO	ABN410 ①		B: black G: green R: red S: blue W: white Y: yellow	
		1NC	ABN401 ①			
		1NO-1NC	ABN411 ①			
		2NO	ABN420 ①			
		2NC	ABN402 ①			
		2NO-2NC	ABN422 ①			
Jumbo Mushroom with Shallow Shroud ABN4G  (nameplate sold separately)	Momentary	1NO	ABN4G10 ①	B: black G: green R: red S: blue W: white Y: yellow		
		1NC	ABN4G01 ①			
		1NO-1NC	ABN4G11 ①			
		2NO	ABN4G20 ①			
		2NC	ABN4G02 ①			
		2NO-2NC	ABN4G22 ①			
Jumbo Mushroom with Deep Shroud ABN4F  (nameplate sold separately)	Momentary	1NO	ABN4F10 ①		B: black G: green R: red S: blue W: white Y: yellow	
		1NC	ABN4F01 ①			
		1NO-1NC	ABN4F11 ①			
		2NO	ABN4F20 ①			
		2NC	ABN4F02 ①			
		2NO-2NC	ABN4F22 ①			
Square Flush UBQN1  (nameplate sold separately)	Momentary	1NO	UBQN110 ①	B: black G: green R: red S: blue W: white Y: yellow		
		1NC	UBQN101 ①			
		1NO-1NC	UBQN111 ①			
		2NO	UBQN120 ①			
		2NC	UBQN102 ①			
		2NO-2NC	UBQN122 ①			
Square Extended UBQN2  (nameplate sold separately)	Momentary	1NO	UBQN210 ①		B: black G: green R: red S: blue W: white Y: yellow	
		1NC	UBQN201 ①			
		1NO-1NC	UBQN211 ①			
		2NO	UBQN220 ①			
		2NC	UBQN202 ①			
		2NO-2NC	UBQN222 ①			

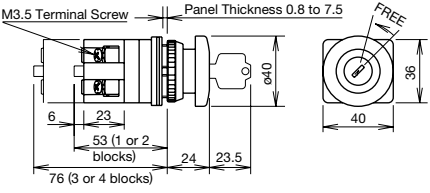
- Specify a button color code in place of ① in the Part No.
- Round/square bezel and shroud (metal): Chrome-plated
- Other contact arrangements and gold-plated silver contacts are also available. See page 20.

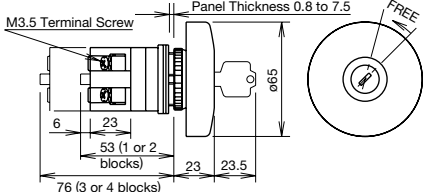
ø30 ø30 series Pushbuttons

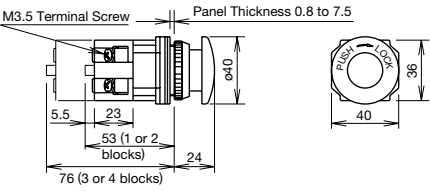
Pushlock Turn Reset / Pushlock Key Reset / Push Turn Lock / Key ON/OFF Lock / Toggle Lever Pushbuttons

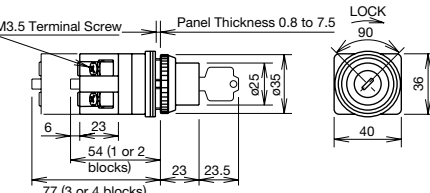
Package Quantity: 1

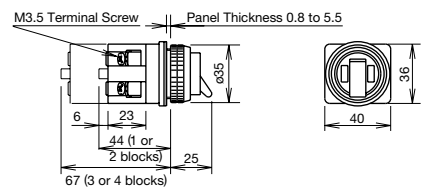





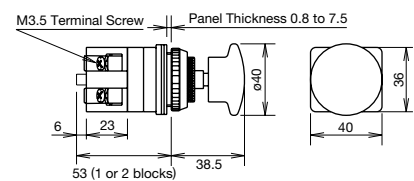

Shape	Contact	Part No.	① Button Color Code	Dimensions (mm)
Mushroom Pushlock Turn Reset AVN3  	1NO	AVN310N①	R: red Y: yellow	
	1NC	AVN301N①		
	1NO-1NC	AVN311N①		
	2NO	AVN320N①		
	2NC	AVN302N①		
Mushroom Pushlock Key Reset ABN3K  	1NO	ABN3K10①	B: black G: green R: red Y: yellow	
	1NC	ABN3K01①		
	1NO-1NC	ABN3K11①		
	2NO	ABN3K20①		
	2NC	ABN3K02①		
Jumbo Mushroom Pushlock Key Reset ABN4K  	1NO	ABN4K10①	B: black G: green R: red	
	1NC	ABN4K01①		
	1NO-1NC	ABN4K11①		
	2NO	ABN4K20①		
	2NC	ABN4K02①		
Pushlock Push Turn Lock AJN3  	1NO	AJN310N①	B: black G: green R: red Y: yellow	
	1NC	AJN301N①		
	1NO-1NC	AJN311N①		
	2NO	AJN320N①		
	2NC	AJN302N①		
Key ON/OFF Lock ABN5  	1NO	ABN510	-	
	1NC	ABN501		
	1NO-1NC	ABN511		
	2NO	ABN520		
	2NC	ABN502		
Toggle Lever ATN4  	1NO	ATN410	Lever: black	
	1NC	ATN401		
	1NO-1NC	ATN411		
	2NO	ATN420		
	2NC	ATN402		
	2NO-2NC	ATN422		

- Specify a button color code in place of ① in the Part No.
 - Round bezel (metal): Chrome-plated
 - Cylinder (metal): Chrome-plated
 - Other contact arrangements and gold-plated silver contacts are also available. See page 20.
 - **Pushlock Turn Reset:** Button is maintained when pressed and is reset when turned clockwise. Red buttons only.
- Note: ø30 pushlock turn reset switches cannot be used as emergency stop switches. When emergency stop switches are required, use XN or HN series emergency stop switches (ISO 13850 and IEC 60947-5-5 compliant).
- **Pushlock Key Reset:** Button is maintained when pressed and is reset with a key. Key is removable from both depressed and reset positions. Two keys are supplied.
- Note: ø30 pushlock key reset switches cannot be used as emergency stop switches. When emergency stop switches are required, use HW series emergency stop switches with a HW9Z-A30 ring adapter (ISO 13850 and IEC 60947-5-5 compliant).
- **Push Turn Lock:** Button is locked when turned clockwise in the depressed position and is reset when turned counterclockwise.
 - **Key ON/OFF Lock:** Button can be locked in both depressed and reset positions.
 - **Toggle Lever:** ON and OFF are indicated on the cap.

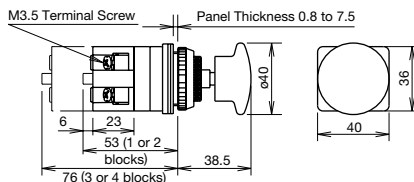
ø30 Series Pushbuttons ø30

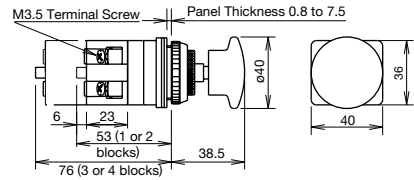
Pull / Push-Pull / Pin Lock Pushbuttons

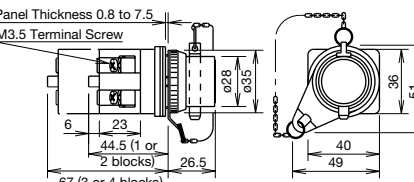
Package Quantity: 1

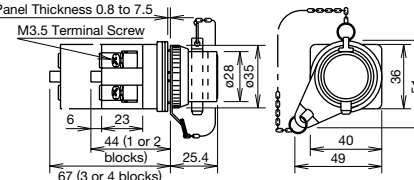
Shape	Contact	Part No.	① Button Color Code	Dimensions (mm)			
Mushroom Pull ATN23  (nameplate sold separately)	1NO	ATN2310 ①	B: black G: green R: red Y: yellow				
	1NO-1NC	ATN2311 ①					
	2NO	ATN2320 ①					
	2NC	ATN2302 ①					
Mushroom Push-Pull ATN21  (nameplate sold separately)	1NO-1NC	ATN2111 ①		B: black G: green R: red Y: yellow			
	2NO	ATN2120 ①					
	2NO-2NC	ATN2122 ①					
Mushroom Push-Pull (Spring Return) ATN22  (nameplate sold separately)	1NO-1NC	ATN2211 ①			B: black G: green R: red Y: yellow		
	2NO-2NC	ATN2222 ①					
Pin Lock ABN8P  (nameplate sold separately)	1NO	ABN8P10				-	
	1NC	ABN8P01					
	1NO-1NC	ABN8P11					
	2NO	ABN8P20					
	2NC	ABN8P02					
Pin Lock (ON Lock) ABN8P**-TK231-1 	1NO	ABN8P10-TK231-1	-				
	1NC	ABN8P01-TK231-1					
	1NO-1NC	ABN8P11-TK231-1					
	2NO	ABN8P20-TK231-1					
	2NC	ABN8P02-TK231-1					
2NO-2NC	ABN8P22-TK231-1						

- Specify a button color code in place of ① in the Part No.
 - Round bezel and shroud (metal): Chrome-plated
 - Square bezel (metal): Chrome-plated
 - Other contact arrangements and gold-plated silver contacts are also available. See page 20.
 - Pull:** Pulling the button operates the contacts. Up to 2 contact blocks (1 layer) can be mounted on pull switches.
 - Push-Pull:** Button is maintained in both depressed and reset positions.
- Note: ø30 push pull switches cannot be used as emergency stop switches. When emergency stop switches are required, use XN series emergency stop switches (ISO 13850 and IEC 60947-5-5 compliant).
- Push-Pull (Spring Return):** Pushing or pulling the button operates the contacts. Button is spring-returned to the center position.
 - Pin Lock:** Button can be locked in either depressed or reset position by inserting the pin. Pad lock with a ø6mm pin can also be used to lock the button.
 - Pin Lock (ON Lock):** Button is locked in the depressed position by inserting the pin. Button cannot be locked in the reset position.

Contact Operation

Pull Switch (Spring Return)

Contact	ATN23	
	Normal	Pull
1NO		
1NC		
1NO-1NC		
2NO		
2NC		

Push-Pull Switch (Maintained)

Contact	ATN21	
	Push	Pull
1NO-1NC		
2NO		
2NC		
2NO-2NC		









Push-Pull (Spring Return)

Contact	ATN22		
	Push	Normal	Pull
1NO-1NC			
2NO-2NC			

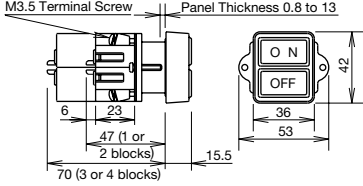
ø30 ø30 series Pushbuttons

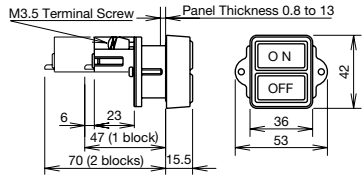
Square Twin / Twin Maintained Pushbuttons

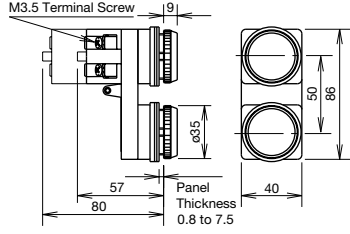
Package Quantity: 1

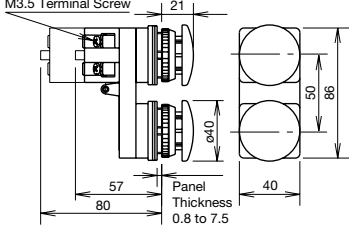

Shape	Contact		Part No.	Button Color	Dimensions (mm)
Square Twin (Momentary) UWQN1  	ON	OFF		ON: Black OFF: Red	
	1NO	1NO	UWQN11010		
	1NO	1NC	UWQN11001		
	2NO	2NC	UWQN12002		
Square Twin (Maintained) UWQN2  	ON	OFF		ON: Black OFF: Red	
	1NO	–	UWQN21000		
	1NC	–	UWQN20100		
	1NO-1NC	–	UWQN21100		
	2NO	–	UWQN22000		
	2NC	–	UWQN20200		
Flush Twin Maintained ABBN11  	Top	Bottom		Black (B), green (G), and red (R) buttons are supplied with each unit.	
	1NO	–	ABBN1110		
	1NC	–	ABBN1101		
	1NO-1NC	–	ABBN1111		
	2NO	–	ABBN1120		
	2NC	–	ABBN1102		
	2NO-2NC	–	ABBN1122		
Mushroom Twin Maintained (Without buttons) ABBN33  	Top	Bottom			
	1NO	–	ABBN3310		
	1NC	–	ABBN3301		
	1NO-1NC	–	ABBN3311		
	2NO	–	ABBN3320		
	2NC	–	ABBN3302		
	2NO-2NC	–	ABBN3322		

- Round bezel (metal): Chrome-plated
 - Other contact arrangements and gold-plated silver contacts are also available. See page 20.
 - **Square Twin (Momentary):** Two independent momentary switches are contained in one unit, each operated by ON or OFF button. With the ø30 adapter removed from the sleeve, the unit can mount in a ø25.5mm mounting hole for the ø25 series.
 - **Square Twin (Maintained):** The contact operates when ON button is pressed and is maintained in the depressed position. The button is reset by pressing the OFF button.
 - **Twin Maintained:** The contact operates when the top button is pressed and is maintained in the depressed position. The button is reset by pressing the bottom button.
- Different combinations of flush, extended HW9Z-A30 buttons, and colors are available (ABN1B-*, ABN2B-*). See page 73.
 Mushroom buttons for the ABBN33 are ordered separately. Specify the color code (ABN3B-*). See page 73.

ø30 Series Pilot Lights ø30

Dome Pilot Lights

Package Quantity: 1

Shape	Lamp	Lamp Receptacle	Part No.	② Lens/LED Color Code	Applicable Lamp
  	Without Lamp	BA9S	APN199 ②	DNA: amber C: clear G: green O: orange R: red S: blue W: white DNY: yellow	See page 75 for lamps.
		E12	APNE199 ②		
	LED	BA9S	APN1 ③ DN ②	A: amber G: green PW: pure white R: red S: blue W: white Y: yellow	LSTD-*②
		E12	APNE1 ③ DN ②		A: amber G: green R: red S: blue W: white Y: yellow
	Incandescent	BA9S	APN1 ③②	C: clear G: green O: orange R: red S: blue W: white	LS-*
		E12	APN1 ③②		LE-*

Operating Voltage Code

Specify an operating voltage code in place of ③ in the Part No.

③ Operating Voltage Code			Input
LED	Incandescent (BA9S)	Incandescent (E12)	
66: 6V AC/DC 11: 12V AC/DC 22: 24V AC/DC	66: 6V AC/DC 88: 12V AC/DC 33: 24V AC/DC		Full Voltage
16: 100/110V AC 126: 120V AC 26: 200/220V AC 246: 240V AC 386: 380V AC 46: 400/440V AC	16: 100/110V AC 126: 120V AC 26: 200/220V AC 246: 240V AC 386: 380V AC 46: 400/440V AC 486: 480V AC	18: 100/110V AC 128: 120V AC 238: 200/220V AC 248: 240V AC 388: 380V AC 48: 400/440V AC 488: 480V AC	Transformer
16D: 110V DC			DC-DC Converter *

- Specify a lens/LED color code in place of ② in the Part No.
- Use a white lens for LED pure white illumination (LSTD).
- Use a pure white LED lamp for yellow illumination.
- * DC-DC converter types are not approved by UL and CSA, and not CE compliant (operating voltage 90 to 140V DC).

Dimensions

Full Voltage

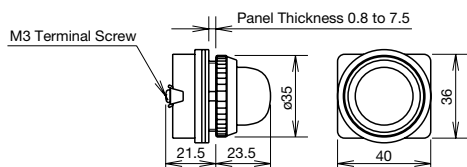

Transformer DC-DC Converter

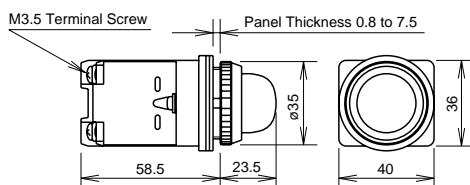







All dimensions in mm.

ø30 ø30 series Pilot Lights

Square / Rectangular (Marking) Pilot Lights

Package Quantity: 1

Shape	Lamp	Lamp Receptacle	Part No.	② Lens/LED Color Code		Applicable Lamp
Square UPQN3B  	Without Lamp	BA9S	UPQN3B99 ②	DA: amber G: green R: red W: white	C: clear O: orange S: blue DY: yellow	See page 75 for lamps.
	LED	BA9S	UPQN3B ③ D ②	A: amber R: red W: white	G: green S: blue Y: yellow	LSTD-*②
	Incandescent	BA9S	UPQN3B ③②	C: clear O: orange S: blue	G: green R: red W: white	LS-*
Rectangular (Marking) UPQN4  	Without Lamp	BA9S	UPQN499 ②	DA: amber O: orange S: blue DY: yellow	G: green R: red W: white	See page 75 for lamps.
	LED	BA9S	UPQN4 ③ D ②	A: amber R: red W: white	G: green S: blue Y: yellow	LSTD-*②
	Incandescent	BA9S	UPQN4 ③②	G: green R: red W: white	O: orange S: blue	LS-*
Rectangular (Marking) UPQNE4 UPQN4  	Without Lamp	E12	UPQNE499 ②	DA: amber O: orange S: blue DY: yellow	G: green R: red W: white	See page 75 for lamps.
	LED	E12	UPQNE4 ③ D ②	A: amber R: red W: white	G: green S: blue Y: yellow	LETD-*②
	Incandescent	E12	UPQN4 ③② (Note)	G: green R: red W: white	O: orange S: blue	LE-*

Operating Voltage Code

Specify an operating voltage code in place of ③ in the Part No.

③ Operating Voltage Code			Input Type
LED	Incandescent (BA9S)	Incandescent (E12)	
66: 6V AC/DC 11: 12V AC/DC 22: 24V AC/DC	66: 6V AC/DC 88: 12V AC/DC 33: 24V AC/DC	66: 6V AC/DC 88: 12V AC/DC 33: 24V AC/DC (Note) When ordering 6V, 12V, 24V AC/DC units, specify "E" before the operating voltage code. UPQN4E③②.	Full Voltage
16: 100/110V AC 126: 120V AC 26: 200/220V AC 246: 240V AC 386: 380V AC 46: 400/440V AC	16: 100/110V AC 126: 120V AC 26: 200/220V AC 246: 240V AC 386: 380V AC 46: 400/440V AC 486: 480V AC	18: 100/110V AC 128: 120V AC 238: 200/220V AC 248: 240V AC 388: 380V AC 48: 400/440V AC 488: 480V AC	Transformer
16D: 110V DC			DC-DC Converter *

- Specify a lens/LED color code in place of ② in the Part No.
- Use a pure white LED lamp for yellow illumination (LSTD)
- On the rectangular marking pilot light, a clear lens and a color marking plate are used for white illumination.
Marking plate: 24 × 30 mm, 2 mm thick
- * DC-DC converter types are not approved by UL and CSA, and not CE compliant (operating voltage 90 to 140V DC).

Dimensions

Square Full Voltage UPQN3B

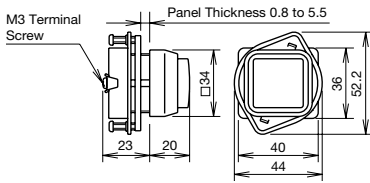

Rectangular Full Voltage UPQN4

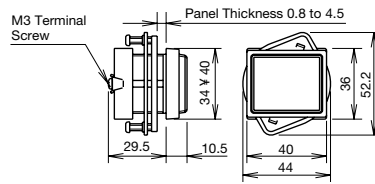

Rectangular Full Voltage UPQNE4

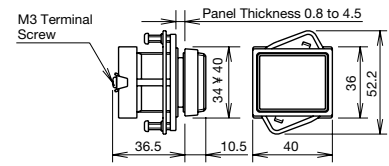

Square Transformer Square DC-DC Converter UPQN3B

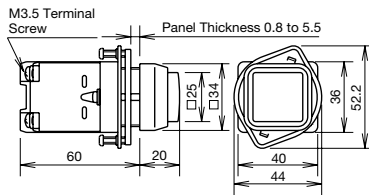

Rectangular Transformer Rectangular DC-DC Converter UPQN4

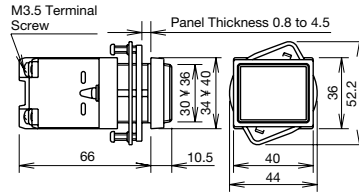

Rectangular Transformer Rectangular DC-DC Converter UPQNE4

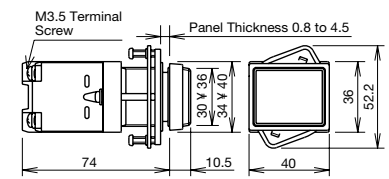

All dimensions in mm.

Reflector

1. The lamp housing of the square LED illuminated pilot lights has a built-in reflector.
2. Make sure that the reflector does not fall off when removing the lens or marking plate.
3. When replacing the LED lamp of UPQNE4 (rectangular), use a lamp holder tool (OR-55).
4. To remove the reflector, insert a flat screwdriver inside the groove of the reflector and lightly push out.

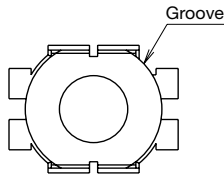

Panel Mounting

1. Tighten the square ring to the operator and position the ring correctly.
2. Lightly tighten the screw to secure the pilot light onto the panel.

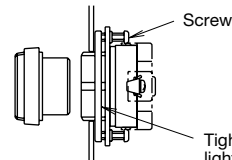



Tighten the screw lightly so that the panel does not bend.

Recommended tightening torque: 0.15 N·m

ø30 ø30 Series Pilot Lights

Incandescent Push-to-Check Pilot Lights (1W)

Package Quantity: 1

Shape	Lamp	Lamp Receptacle	Part No.	② Lens/LED Color Code	Applicable Lamp
Push-to-Check APN1*P  	Without Lamp	BA9S	APN199P ②	C: clear G: green O: orange R: red S: blue W: white	See page 75 for lamps.
	Incandescent	BA9S	APN1 ③ P ②		LS-*

Operating Voltage Code

Specify an operating voltage code in place of ③ in the Part No.

③ Operating Voltage Code	Input
66: 6V AC/DC 88: 12V AC/DC 33: 24V AC/DC	Full voltage
16: 100/110V AC 126: 120V AC 26: 200/220V AC 246: 240V AC 386: 380V AC 46: 400/440V AC 486: 480V AC	Transformer

Circuit Example

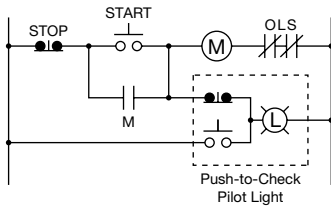

Note: The lamp of the push-to-check pilot light is not connected to the contact terminal. To connect, refer to the diagram on the left.

Dimensions

Push-to-Check
APN1*P

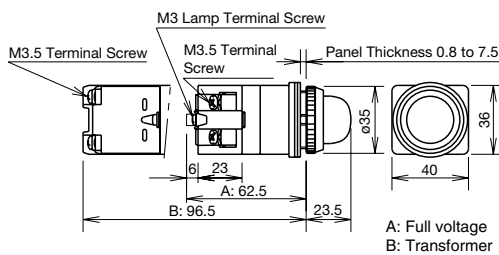

All dimensions in mm.

ø30 Series Illuminated Pushbuttons ø30

LED Round Extended Illuminated Pushbuttons

Package Quantity: 1

Shape	Lamp Receptacle	Operation	Lamp	Contact	Part No.	Applicable Lamp	
Round Extended ALN2 AOLN2 ALNE2 AOLNE2 	BA9S	Momentary	Without Lamp	1NO-1NC	ALN29911DN②	See page 75 for lamps.	
				2NO	ALN29920DN②		
				2NC	ALN29902DN②		
		LED	Without Lamp	1NO-1NC	ALN2③11DN②	LSTD-*②	
				2NO	ALN2③20DN②		
				2NC	ALN2③02DN②		
	E12	Momentary	Without Lamp	Without Lamp	1NO-1NC	AOLN29911DN②	See page 75 for lamps.
					2NO	AOLN29920DN②	
					2NC	AOLN29902DN②	
		LED	Without Lamp	1NO-1NC	ALNE2③11DN②	LETD-*②	
				2NO	ALNE2③20DN②		
				2NC	ALNE2③02DN②		
Maintained	Without Lamp	Without Lamp	Without Lamp	1NO-1NC	AOLNE29911DN②	See page 75 for lamps.	
				2NO	AOLNE29920DN②		
				2NC	AOLNE29902DN②		
LED	Without Lamp	Without Lamp	Without Lamp	1NO-1NC	AOLNE2③11DN②	LETD-*②	
				2NO	AOLNE2③20DN②		
				2NC	AOLNE2③02DN②		

Color Code and Operating Voltage Code

② Lens/LED Color Code	③ Operating Voltage Code	Input
Specify a lens/LED color code in place of ②. A: amber G: green PW: pure white (LSTD only) R: red S: blue W: white Y: yellow A pure white LED lamp is used for yellow illumination.	66: 6V AC/DC 11: 12V AC/DC 22: 24V AC/DC 16: 100/110V AC 126: 120V AC 26: 200/220V AC 246: 240V AC 386: 380V AC 46: 400/440V AC	Full voltage Transformer

Dimensions

ALN2/AOLN2

BA9S/Full Voltage

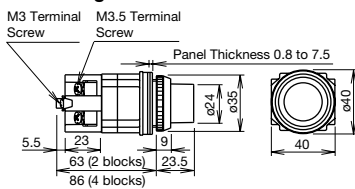

ALN2/AOLN2

BA9S/Transformer

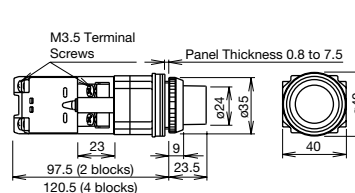

ALNE2/AOLNE2

E12/Full Voltage

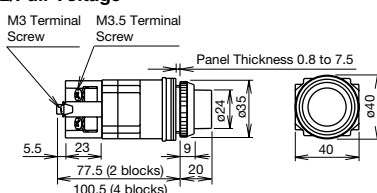

ALNE2/AOLNE2

E12/Transformer

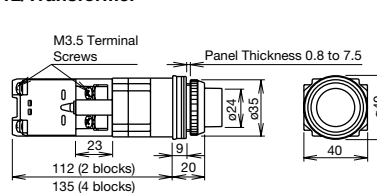

All dimensions in mm.

ø30 ø30 series Illuminated Pushbuttons

Incandescent Round Extended Illuminated Pushbuttons

Package Quantity: 1

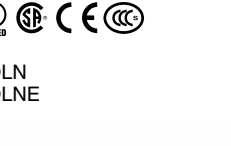
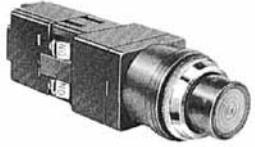
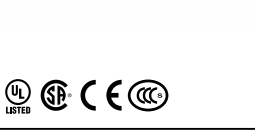
Shape	Lamp Receptacle	Operation	Lamp	Contact	Part No.	Applicable Lamp	
Round Extended ALN ALNE   AOLN AOLNE  	BA9S	Momentary	Without Lamp	1NO-1NC	ALN9911②	See page 75 for lamps.	
				2NO	ALN9920②		
				2NC	ALN9902②		
			Incandescent		1NO-1NC	ALN③11②	LS-*
					2NO	ALN③20②	
					2NC	ALN③02②	
	E12	Momentary	Without Lamp	1NO-1NC	AOLN9911②	See page 75 for lamps.	
				2NO	AOLN9920②		
				2NC	AOLN9902②		
			Incandescent		1NO-1NC	ALN③11②	LE-*
					2NO	ALN③20②	
					2NC	ALN③02②	
E12	Maintained	Without Lamp	1NO-1NC	AOLNE9911②	See page 75 for lamps.		
			2NO	AOLNE9920②			
			2NC	AOLNE9902②			
		Incandescent		1NO-1NC	AOLN③11②	LE-*	
				2NO	AOLN③20②		
				2NC	AOLN③02②		

Color Code and Operating Voltage Code

Specify a code in place of ② or ③ in the Part No.

② Lens Color Code	③ Operating Voltage Code		Input
	Incandescent (BA9S)	Incandescent (E12)	
Specify a lens color code in place of ②. C: clear G: green O: orange R: red S: blue W: white	66: 6V AC/DC 88: 12V AC/DC 33: 24V AC/DC	E66: 6V AC/DC E88: 12V AC/DC E33: 24V AC/DC	Full voltage
	16: 100/110V AC 126: 120V AC 26: 200/220V AC 246: 240V AC 386: 380V AC 46: 400/440V AC 486: 480V AC	18: 100/110V AC 128: 120V AC 238: 200/220V AC 248: 240V AC 388: 380V AC 48: 400/440V AC 488: 480V AC	Transformer

Dimensions

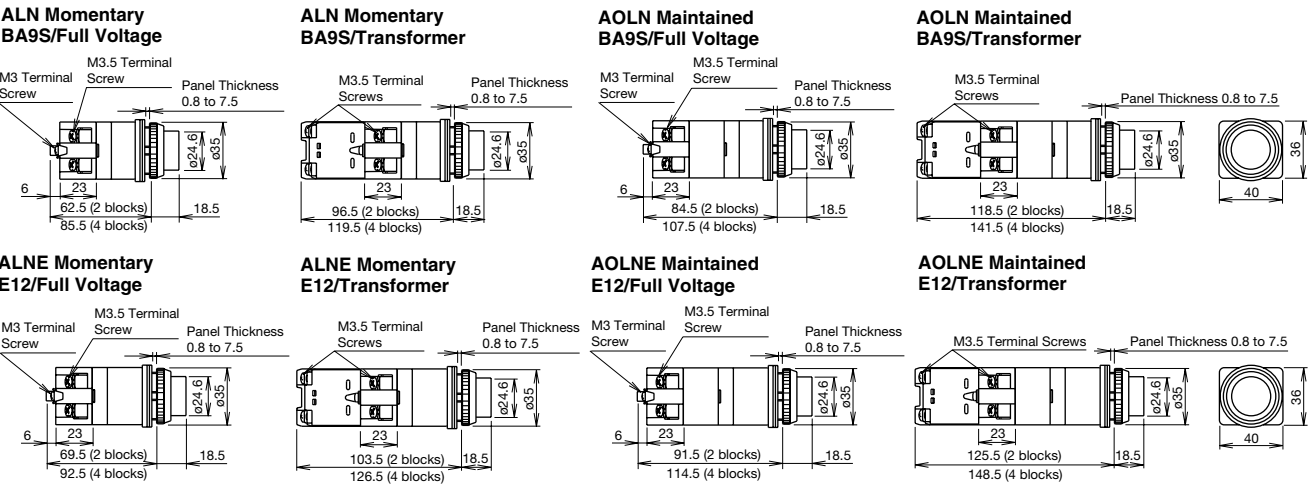

ø30 Series Illuminated Pushbuttons ø30

LED Round Extended with Half Shroud Illuminated Pushbuttons

Package Quantity: 1

Shape	Lamp Receptacle	Operation	Lamp	Contact	Part No.	Applicable Lamp	
	BA9S	Momentary	Without Lamp	1NO-1NC	ALGN29911DN ②	See page 75 for lamps.	
				2NO	ALGN29920DN ②		
				2NC	ALGN29902DN ②		
		LED	Without Lamp	1NO-1NC	ALGN2 ③ 11DN ②	LSTD-*②	
				2NO	ALGN2 ③ 20DN ②		
				2NC	ALGN2 ③ 02DN ②		
	E12	Momentary	Without Lamp	Without Lamp	1NO-1NC	AOLGN29911DN ②	See page 75 for lamps.
					2NO	AOLGN29920DN ②	
					2NC	AOLGN29902DN ②	
		LED	Without Lamp	1NO-1NC	AOLGN2 ③ 11DN ②	LSTD-*②	
				2NO	AOLGN2 ③ 20DN ②		
				2NC	AOLGN2 ③ 02DN ②		
E12	Maintained	Without Lamp	Without Lamp	1NO-1NC	ALGNE29911DN ②	See page 75 for lamps.	
				2NO	ALGNE29920DN ②		
				2NC	ALGNE29902DN ②		
	LED	Without Lamp	1NO-1NC	ALGNE2 ③ 11DN ②	LETD-*②		
			2NO	ALGNE2 ③ 20DN ②			
			2NC	ALGNE2 ③ 02DN ②			
E12	Maintained	Without Lamp	Without Lamp	1NO-1NC	AOLGNE29911DN ②	See page 75 for lamps.	
				2NO	AOLGNE29920DN ②		
				2NC	AOLGNE29902DN ②		
	LED	Without Lamp	1NO-1NC	AOLGNE2 ③ 11DN ②	LETD-*②		
			2NO	AOLGNE2 ③ 20DN ②			
			2NC	AOLGNE2 ③ 02DN ②			



Color Code and Operating Voltage Code

Specify a code in place of ② or ③ in the Part No.

② Lens/LED Color Code	③ Operating Voltage Code	Input
Specify a lens/LED color code in place of ②. A: amber G: green PW: pure white (LSTD only) R: red S: blue W: white Y: yellow Use a pure white LED lamp for yellow illumination	66: 6V AC/DC 11: 12V AC/DC 22: 24V AC/DC 16: 100/110V AC 126: 120V AC 26: 200/220V AC 246: 240V AC 386: 380V AC 46: 400/440V AC	Full voltage Transformer

Dimensions

**ALGN2/AOLGN2
BA9S/Full Voltage**

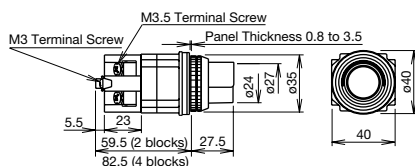

**ALGN2/AOLGN2
BA9S/Transformer**

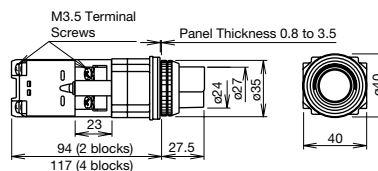

**ALGNE2/AOLGNE2
E12/Full Voltage**

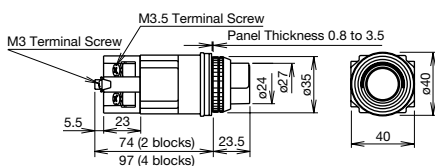

**ALGNE2/AOLGNE2
E12/Transformer**

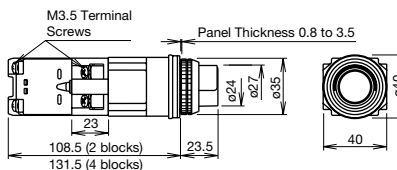



All dimensions in mm.

ø30 ø30 series Illuminated Pushbuttons

Incandescent Round Extended with Half Shroud Illuminated Pushbuttons

Package Quantity: 1

Shape	Lamp Receptacle	Operation	Lamp	Contact	Part No.	Applicable Lamp
Round Extended ALN□G ALNE□G  	BA9S	Momentary	Without Lamp	1NO-1NC	ALN9G911②	See page 75 for lamps.
				2NO	ALN9G920②	
				2NC	ALN9G902②	
			Incandescent	1NO-1NC	ALN③11②	LS-*
				2NO	ALN③20②	
				2NC	ALN③02②	
	E12	Momentary	Without Lamp	1NO-1NC	ALNE9G911②	See page 75 for lamps.
				2NO	ALNE9G920②	
				2NC	ALNE9G902②	
			Incandescent	1NO-1NC	ALN③11②	LE-*
				2NO	ALN③20②	
				2NC	ALN③02②	

Color Code and Operating Voltage Code

Specify a code in place of ② or ③ in the Part No.

② Lens Color Code	③ Operating Voltage Code		Input
	Incandescent (BA9S)	Incandescent (E12)	
Specify a lens color code in place of ②. C: clear G: green O: orange R: red S: blue W: white	6G6: 6V AC/DC 8G8: 12V AC/DC 3G3: 24V AC/DC 1G6: 100/110V AC 12G6: 120V AC 2G6: 200/220V AC 24G6: 240V AC 38G6: 380V AC 4G6: 400/440V AC 48G6: 480V AC	E6G6: 6V AC/DC E8G8: 12V AC/DC E3G3: 24V AC/DC 1G8: 100/110V AC 12G8: 120V AC 2G8: 200/220V AC 24G8: 240V AC 38G8: 380V AC 4G8: 400/440V AC 48G8: 480V AC	Full voltage Transformer

Dimensions

ALN*G Momentary BA9S/Full Voltage

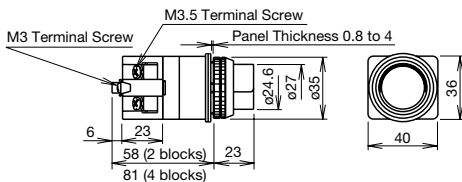

ALN*G Momentary BA9S/Transformer

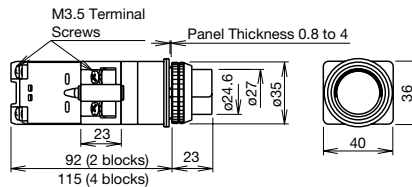

ALNE*G Momentary E16/Full Voltage

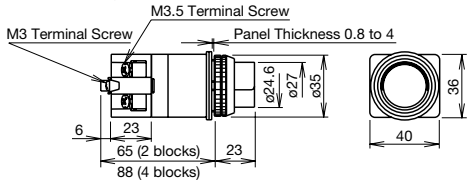

ALNE*G Momentary E16/Transformer

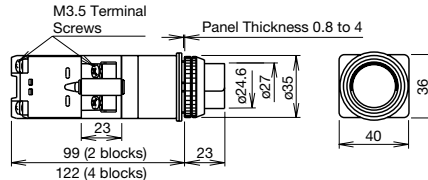

All dimensions in mm.

ø30 Series Illuminated Pushbuttons ø30

LED Round Extended with Full Shroud Illuminated Pushbuttons

Package Quantity: 1

Shape	Lamp Receptacle	Operation	Lamp	Contact	Part No.	Applicable Lamp	
Round Extended ALFN2 AOLFN2 ALFNE2 AOLFNE2 	BA9S	Momentary	Without Lamp	1NO-1NC	ALFN29911DN ②	See page 75 for lamps.	
				2NO	ALFN29920DN ②		
				2NC	ALFN29902DN ②		
			LED	1NO-1NC	ALFN2 ③ 11DN ②		LSTD-*②
				2NO	ALFN2 ③ 20DN ②		
				2NC	ALFN2 ③ 02DN ②		
		Maintained	Without Lamp	1NO-1NC	AOLFN29911DN ②	See page 75 for lamps.	
				2NO	AOLFN29920DN ②		
				2NC	AOLFN29902DN ②		
			LED	1NO-1NC	AOLFN2 ③ 11DN ②		LSTD-*②
				2NO	AOLFN2 ③ 20DN ②		
				2NC	AOLFN2 ③ 02DN ②		
	E12	Momentary	Without Lamp	1NO-1NC	ALFNE29911DN ②	See page 75 for lamps.	
				2NO	ALFNE29920DN ②		
				2NC	ALFNE29902DN ②		
			LED	1NO-1NC	ALFNE2 ③ 11DN ②		LETD-*②
				2NO	ALFNE2 ③ 20DN ②		
				2NC	ALFNE2 ③ 02DN ②		
		Maintained	Without Lamp	1NO-1NC	AOLFNE29911DN ②	See page 75 for lamps.	
				2NO	AOLFNE29920DN ②		
				2NC	AOLFNE29902DN ②		
			LED	1NO-1NC	AOLFNE2 ③ 11DN ②		LETD-*②
				2NO	AOLFNE2 ③ 20DN ②		
				2NC	AOLFNE2 ③ 02DN ②		

Color Code and Operating Voltage Code

Specify a code in place of ② or ③ in the Part No.

② Lens/LED Color Code	③ Operating Voltage Code	Input
LED Specify a lens/LED color code in place of ②. A: amber G: green PW: pure white (LSTD only) R: red S: blue W: white Y: yellow Use a pure white LED lamp for yellow illumination	66: 6V AC/DC 11: 12V AC/DC 22: 24V AC/DC 16: 100/110V AC 126: 120V AC 26: 200/220V AC 246: 240V AC 386: 380V AC 46: 400/440V AC	Full voltage Transformer

Dimensions

**ALFN2/AOLFN2
BA9S/Full Voltage**

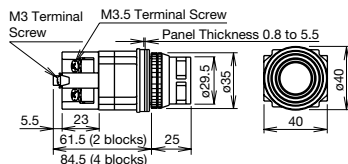

**ALFN2/AOLFN2
BA9S/Transformer**

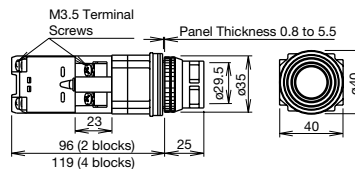

**ALFNE2/AOLFNE2
E12/Full Voltage**

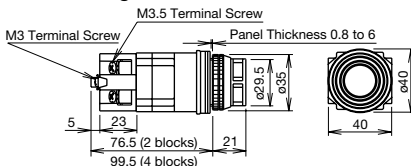

**ALFNE2/AOLFNE2
E12/Transformer**

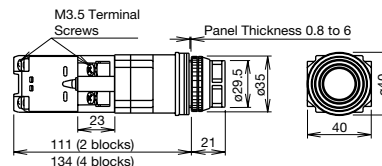





All dimensions in mm.

ø30 ø30 series Illuminated Pushbuttons

Incandescent Round Extended with Full Shroud Illuminated Pushbuttons

Package Quantity: 1

Shape	Lamp Receptacle	Operation	Lamp	Contact	Part No.	Applicable Lamp	
Round Extended ALN□F ALNE□F  AOLN□F AOLNE□F   	BA9S	Momentary	Without Lamp	1NO-1NC	ALN9F911②	See page 75 for lamps.	
				2NO	ALN9F920②		
				2NC	ALN9F902②		
		Incandescent	Without Lamp	1NO-1NC	ALN③11②	LS-*	
				2NO	ALN③20②		
				2NC	ALN③02②		
	E12	Momentary	Without Lamp	Without Lamp	1NO-1NC	AOLN9F911②	See page 75 for lamps.
					2NO	AOLN9F920②	
					2NC	AOLN9F902②	
		Incandescent	Without Lamp	1NO-1NC	ALN③11②	LE-*	
				2NO	ALN③20②		
				2NC	ALN③02②		
Maintained	Without Lamp	Without Lamp	Without Lamp	1NO-1NC	AOLNE9F911②	See page 75 for lamps.	
				2NO	AOLNE9F920②		
				2NC	AOLNE9F902②		
Incandescent	Without Lamp	Without Lamp	Without Lamp	1NO-1NC	AOLN②11②	LE-*	
				2NO	AOLN②20②		
				2NC	AOLN②02②		

Color Code and Operating Voltage Code

Specify a code in place of ② or ③ in the Part No.

② Lens Color Code	③ Operating Voltage Code		Input
	Incandescent (BA9S)	Incandescent (E12)	
Specify a lens color code in place of ②. C: clear G: green O: orange R: red S: blue W: white	6F6: 6V AC/DC 8F8: 12V AC/DC 3F3: 24V AC/DC	E6F6: 6V AC/DC E8F8: 12V AC/DC E3F3: 24V AC/DC	Full voltage
	1F6: 100/110V AC 12F6: 120V AC 2F6: 200/220V AC 24F6: 240V AC 38F6: 380V AC 4F6: 400/440V AC 48F6: 480V AC	1F8: 100/110V AC 12F8: 120V AC 2F8: 200/220V AC 24F8: 240V AC 38F8: 380V AC 4F8: 400/440V AC 48F8: 480V AC	Transformer

Dimensions

ALN*F Momentary BA9S/Full Voltage

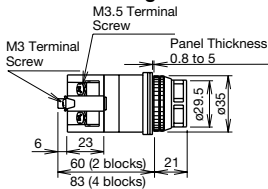

ALN*F Momentary BA9S/Transformer

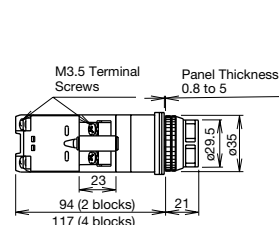

AOLN*F Maintained BA9S/Full Voltage

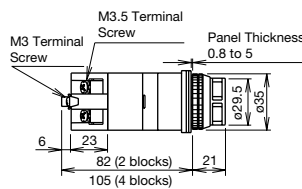

ALON*F Maintained BA9S/Transformer

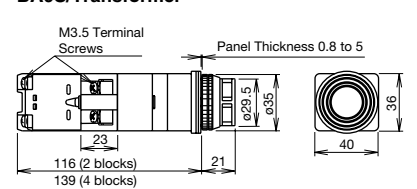

All dimensions in mm.

ALNE*F Momentary E12/Full Voltage

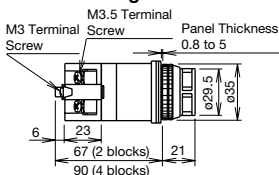

ALN*F Momentary E12/Transformer

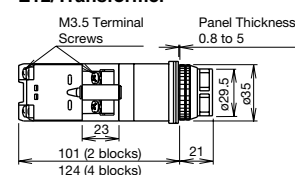

AOLNE*F Maintained E12/Full Voltage

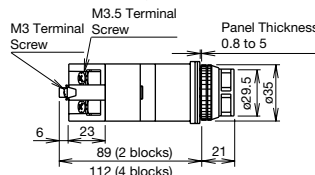

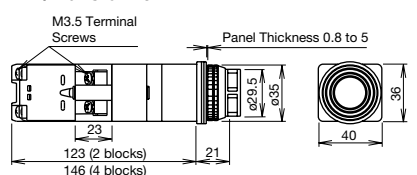

AOLN*F Maintained E12/Transformer



ø30 Series Illuminated Pushbuttons ø30

LED Mushroom (ø40) Illuminated Pushbuttons

Package Quantity: 1

Shape	Lamp Receptacle	Operation	Lamp	Contact	Part No.	Applicable Lamp	
ø40 Mushroom ALN3 AOLN3 ALNE3 AOLNE3  	BA9S	Momentary	Without Lamp	1NO-1NC	ALN39911DN ^②	See page 75 for lamps.	
				2NO	ALN39920DN ^②		
				2NC	ALN39902DN ^②		
		LED		1NO-1NC	ALN3 ^③ 11DN ^②	LSTD-* ^②	
				2NO	ALN3 ^③ 20DN ^②		
				2NC	ALN3 ^③ 02DN ^②		
	E12	Momentary	Without Lamp		1NO-1NC	AOLN39911DN ^②	See page 75 for lamps.
					2NO	AOLN39920DN ^②	
					2NC	AOLN39902DN ^②	
		LED		1NO-1NC	AOLN3 ^③ 11DN ^②	LSTD-* ^②	
				2NO	AOLN3 ^③ 20DN ^②		
				2NC	AOLN3 ^③ 02DN ^②		
E12	Maintained	Without Lamp		1NO-1NC	AOLNE39911DN ^②	See page 75 for lamps.	
				2NO	AOLNE39920DN ^②		
				2NC	AOLNE39902DN ^②		
	LED		1NO-1NC	AOLNE3 ^③ 11DN ^②	LETD-* ^②		
			2NO	AOLNE3 ^③ 20DN ^②			
			2NC	AOLNE3 ^③ 02DN ^②			

Color Code and Operating Voltage Code

Specify a code in place of ② or ③ in the Part No.

② Lens/LED Color Code	③ Operating Voltage Code	Input
Specify a lens/LED color code in place of ②. A: amber G: green R: red S: blue W: white Y: yellow Use a pure white LED lamp for yellow illumination (LSTD only)	66: 6V AC/DC 11: 12V AC/DC 22: 24V AC/DC 16: 100/110V AC 126: 120V AC 26: 200/220V AC 246: 240V AC 386: 380V AC 46: 400/440V AC	Full voltage Transformer

Dimensions

ALN3/AOLN3
BA9S/Full Voltage

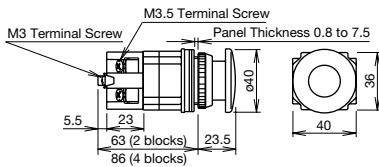

ALN3/AOLN3
BA9S/Transformer

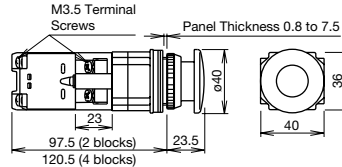

ALNE3/AOLNE3
E12/Full Voltage

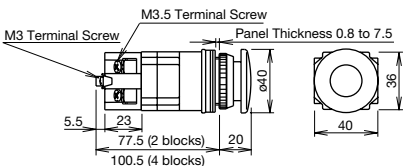

ALNE3/AOLNE3
E12/Transformer

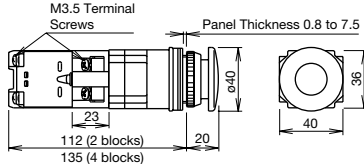

















All dimensions in mm.

ø30 ø30 series Illuminated Pushbuttons

Incandescent Square and Rectangular Extended Illuminated Pushbuttons

Package Quantity: 1

Shape	Lamp Receptacle	Operation	Lamp	Contact	Part No.	Applicable Lamp		
Square Extended ULQN   UOLQN	BA9S	Momentary	Without Lamp	1NO-1NC	ULQN9911②	See page 75 for lamps.		
				2NO	ULQN9920②			
				2NC	ULQN9902②			
		Rectangular (Marking) ULQN□B   UOLQN□B	BA9S	Momentary	Without Lamp	1NO-1NC	ULQN9911②	See page 75 for lamps.
						2NO	ULQN9920②	
						2NC	ULQN9902②	
Square Extended ULQN   UOLQN	BA9S			Maintained	Without Lamp	1NO-1NC	UOLQN9911②	See page 75 for lamps.
						2NO	UOLQN9920②	
						2NC	UOLQN9902②	
		Rectangular (Marking) ULQN□B   UOLQN□B	BA9S	Maintained	Without Lamp	1NO-1NC	UOLQN9911②	See page 75 for lamps.
						2NO	UOLQN9920②	
						2NC	UOLQN9902②	
Square Extended ULQN   UOLQN	BA9S			Momentary	Incandescent	1NO-1NC	ULQN③11②	LS-*
						2NO	ULQN③20②	
						2NC	ULQN③02②	
		Rectangular (Marking) ULQN□B   UOLQN□B	BA9S	Momentary	Incandescent	1NO-1NC	ULQN③11②	LS-*
						2NO	ULQN③20②	
						2NC	ULQN③02②	
Square Extended ULQN   UOLQN	BA9S			Maintained	Incandescent	1NO-1NC	UOLQN③11②	LS-*
						2NO	UOLQN③20②	
						2NC	UOLQN③02②	
		Rectangular (Marking) ULQN□B   UOLQN□B	BA9S	Maintained	Incandescent	1NO-1NC	UOLQN③11②	LS-*
						2NO	UOLQN③20②	
						2NC	UOLQN③02②	

Color Code and Operating Voltage Code

Specify a code in place of ② or ③ in the Part No.

② Lens Color Code	③ Operating Voltage Code		Input
	Square Extended	Rectangular Marking	
Specify a lens color code in place of ②. C: clear (square units only) G: green O: orange R: red S: blue W: white Clear lens is not available for rectangular units.	66: 6V AC/DC 88: 12V AC/DC 33: 24V AC/DC 16: 100/110V AC 126: 120V AC 26: 200/220V AC 246: 240V AC 386: 380V AC 46: 400/440V AC 486: 480V AC	6B6: 6V AC/DC 8B8: 12V AC/DC 3B3: 24V AC/DC 1B6: 100/110V AC 12B6: 120V AC 2B6: 200/220V AC 24B6: 240V AC 38B6: 380V AC 4B6: 400/440V AC 48B6: 480V AC	Full voltage Transformer

Dimensions

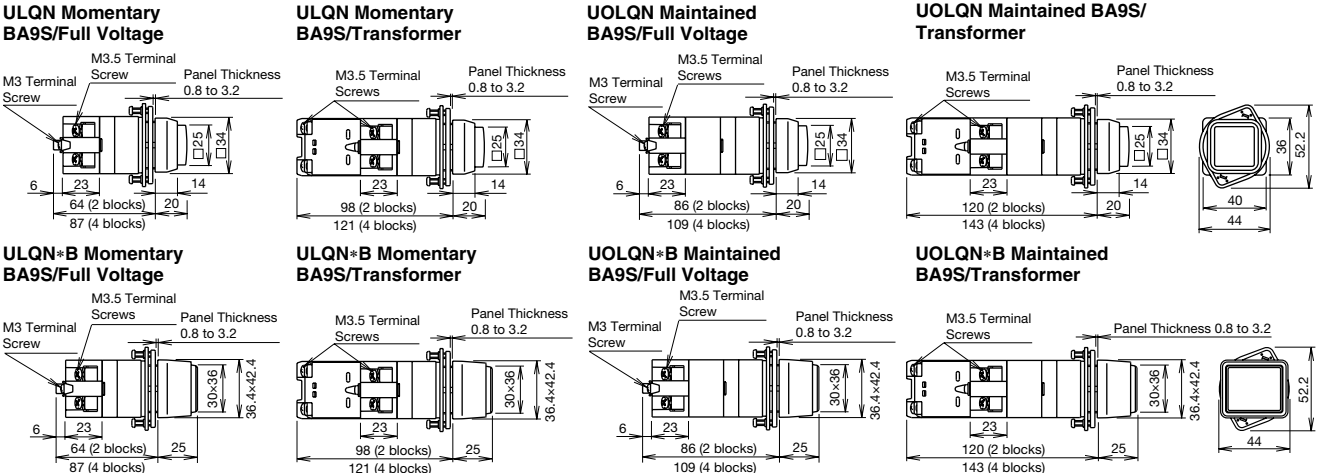



All dimensions in mm.

ø30 Series Illuminated Pushbuttons ø30

Incandescent Push Turn Lock Illuminated Pushbuttons

Package Quantity: 1

Shape	Lamp Receptacle	Operation	Lamp	Contact	Part No.	Applicable Lamp
ALN□L  	BA9S	Push Turn Lock	Without Lamp	1NO-1NC	ALN9L911 ②	See page 75 for lamps.
				2NO	ALN9L920 ②	
				2NC	ALN9L902 ②	
			Incandescent	1NO-1NC	ALN ③ 11 ②	LS-*
				2NO	ALN ③ 20 ②	
				2NC	ALN ③ 02 ②	

Color Code and Operating Voltage Code

Specify a code in place of ② or ③ in the Part No.

② Lens Color Code	③ Operating Voltage Code	Input
Specify a lens color code in place of ②. G: green O: orange R: red S: blue W: white	6L6: 6V AC/DC 8L8: 12V AC/DC 3L3: 24V AC/DC 1L6: 100/110V AC 12L6: 120V AC 2L6: 200/220V AC 24L6: 240V AC 38L6: 380V AC 4L6: 400/440V AC 48L6: 480V AC	Full voltage Transformer

- **Push Turn Lock:** Knob is maintained when turned clockwise in the depressed position and is reset when turned counterclockwise.

Dimensions

ALN*L
BA9S/Full Voltage

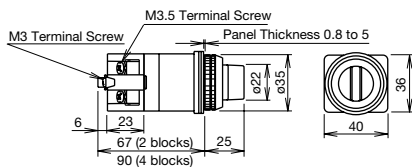

ALN*L
BA9S/Transformer

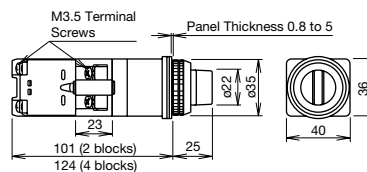





All dimensions in mm.

ø30 ø30 series Illuminated Pushbuttons

LED Pushlock Turn Reset/Push Turn Lock Illuminated Pushbuttons

Package Quantity: 1

Shape	Lamp Receptacle	Operation	Lamp	Contact	Part No.	Applicable Lamp
ø40 Mushroom Pushlock Turn Reset AVLN3 AVLNE3  	BA9S	Pushlock Turn Reset	Without Lamp	1NO-1NC	AVLN39911DNR	See page 75 for lamps.
				2NO	AVLN39920DNR	
				2NC	AVLN39902DNR	
	E12	Pushlock Turn Reset	LED	1NO-1NC	AVLN3③11DNR	LSTD-*②
				2NO	AVLN3③20DNR	
				2NC	AVLN3③02DNR	
ø40 Mushroom Push Turn Lock AJLN3  	BA9S	Push Turn Lock	Without Lamp	1NO-1NC	AJLN39911DN②	See page 75 for lamps.
				2NO	AJLN39920DN②	
				2NC	AJLN39902DN②	
	E12	Push Turn Lock	LED	1NO-1NC	AJLN3③11DN②	LSTD-*②
				2NO	AJLN3③20DN②	
				2NC	AJLN3③02DN②	

Color Code and Operating Voltage Code

Specify a code in place of ② or ③ in the Part No.

② Lens/LED Color Code	③ Operating Voltage Code	Input
Specify a lens/LED color code in place of ②. A: amber G: green R: red W: white Y: yellow	66: 6V AC/DC 11: 12V AC/DC 22: 24V AC/DC	Full voltage
	16: 100/110V AC 126: 120V AC 26: 200/220V AC 246: 240V AC 386: 380V AC 46: 400/440V AC	Transformer

• **Pushlock Turn Reset:** Lens is maintained when pressed and is reset when turned clockwise. Red lens only.

Note: AVNL3 and AVNLE3 pushlock turn reset switches cannot be used as emergency stop switches. When emergency stop switches are required, use XN or HN series emergency stop switches (ISO 13850 and IEC 60947-5-5 compliant).

• **Push Turn Lock:** Lens is maintained when turned clockwise in the depressed position and is reset when turned counterclockwise.

Dimensions

**AVLN3
BA9S/Full Voltage**

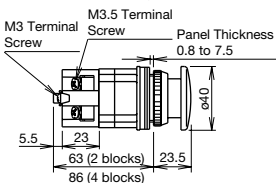

**AVLN3
BA9S/Transformer**

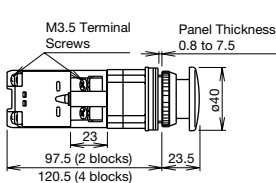

**AVLNE3
E12/Full Voltage**

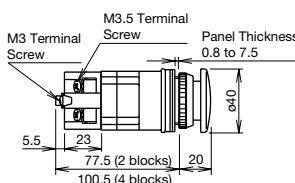

**AVLNE3
E12/Transformer**

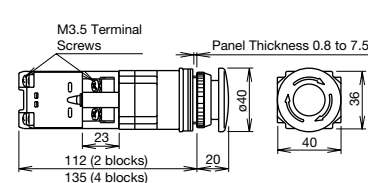

**AJLN3
BA9S/Full Voltage**

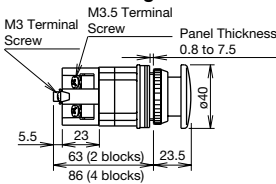

**AJLN3
BA9S/Transformer**

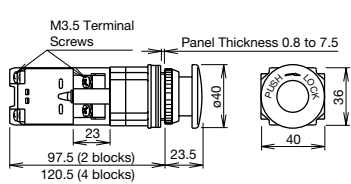





All dimensions in mm.

ø30 Series Illuminated Pushbuttons ø30

Incandescent Pushlock Turn Reset/Push Turn Lock Illuminated Pushbuttons

Package Quantity: 1

Shape	Lamp Receptacle	Operation	Lamp	Contact	Part No.	Applicable Lamp		
ø40 Mushroom Pushlock Turn Reset AVLN3 AVLNE3  	BA9S	Pushlock Turn Reset	Without Lamp	1NO-1NC	AVLN39911NR	See page 75 for lamps.		
				2NO	AVLN39920NR			
				2NC	AVLN39902NR			
	E12	Pushlock Turn Reset	Incandescent		1NO-1NC	AVLN3③11NR	LS-*	
					2NO	AVLN3③20NR		
					2NC	AVLN3③02NR		
ø40 Mushroom Push Turn Lock AJLN3  	BA9S	Push Turn Lock	Without Lamp	1NO-1NC	AJLN39911N②	See page 75 for lamps.		
				2NO	AJLN39920N②			
				2NC	AJLN39902N②			
			Incandescent			1NO-1NC	AJLN3③11N②	LS-*
						2NO	AJLN3③20N②	
						2NC	AJLN3③02N②	

Color Code and Operating Voltage Code

Specify a code in place of ② or ③ in the Part No.

② Lens Color Code	③ Operating Voltage Code		Input
	Incandescent (BA9S)	Incandescent (E12)	
Specify a lens color code in place of ② in the Part No. G: green O: orange R: red	66: 6V AC/DC 88: 12V AC/DC 33: 24V AC/DC	18: 100/110V AC 128: 120V AC 238: 200/220V AC 248: 240V AC 388: 380V AC 48: 400/440V AC 488: 480V AC	Full voltage Transformer

- **Pushlock Turn Reset:** Lens is maintained when pressed and is reset when turned clockwise. Red lens only.
 Note: AVLN3 and AVNLE3 pushlock turn reset switches cannot be used as emergency stop switches. When emergency stop switches are required, use XN or HN series emergency stop switches (ISO 13850 and IEC 60947-5-5 compliant).
- **Push Turn Lock:** Lens is maintained when turned clockwise in the depressed position and is reset when turned counterclockwise.

Dimensions

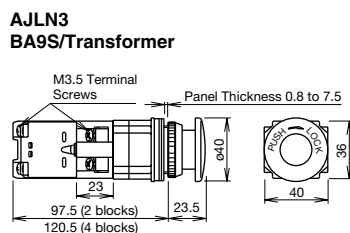
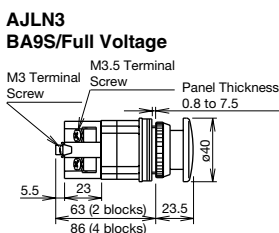
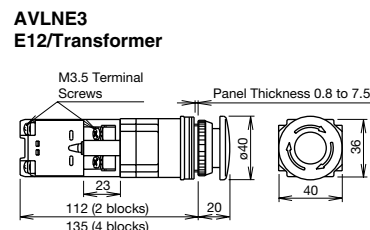
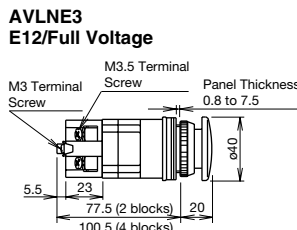
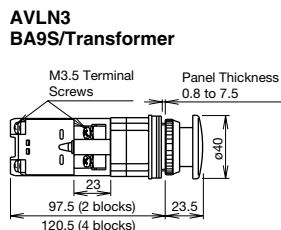
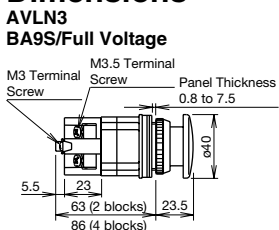





All dimensions in mm.

ø30 ø30 series Selector Switches

ASN Selector Switches (Knob Operator)

90° 2-position

Package Quantity: 1

Shape			ASN				 <ul style="list-style-type: none"> • Knob: Black • Round bezel (metal): Chrome-plated • Units marked with ★ and part numbers with "-T" differ in shape. • See page 48 for dimensions. • Nameplates are ordered separately. 					
Contact Arrangement Chart												
Contact Code	Contact Block		Operator Position		Maintained	Spring Return from Right	Maintained	Spring Return from Left				
	Mounting Position	Contact	L	R								
10 (1NO)	1	NO		●	ASN310	ASN410	/	/				
	2	Dummy										
11 (1NO-1NC)	1	NO		●	ASN311	ASN411						
	2	NC	●									
20 (2NO)	1	NO	●	●	ASN320	ASN420						
	2	NO		●								
22 (2NO-2NC)	1	NO		●	ASN322	ASN422						
	2	NC	●									
	3	NO	●	●								
	4	NC	●									
7S (1NO-1NC)	1	NO	■	■	ASN37S (Note)	ASN47S (Note)						
	2	NC	■	■								
10 (1NO)	1	NO	●		/	/	ASN3010	ASN4010				
	2	Dummy										
11 (1NO-1NC)	1	NO	●						ASN3011	ASN4011		
	2	NC		●								
20 (2NO)	1	NO	●						ASN3020	ASN4020		
	2	NO		●								
22 (2NO-2NC)	1	NO	●						ASN3022	ASN4022		
	2	NC		●								
	3	NO	●	●								
	4	NC		●								
7S (1NO-1NC)	1	NO	■	■	ASN307S (Note)	ASN407S (Note)						
	2	NC	■	■								



Note: The overlapping time is shorter for left to right than right to left. Take overlapping time into consideration.

ø30 Series Selector Switches ø30

ASN Selector Switches (Knob Operator)

45° 3-position

Package Quantity: 1

Shape			ASN				 <ul style="list-style-type: none"> • Knob: Black • Round bezel (metal): Chrome-plated • Units marked with ★ and part numbers with "-T" differ in shape. See page 48 for dimensions. • Nameplates are ordered separately. 								
Contact Arrangement Chart							Maintained		Spring Return from Left		Maintained		Spring Return from Right		
Contact Code	Contact Block		Operator Position			L C R		L C R		L C R		L C R			
	Mounting Position	Contact	L	R	C										
11 (1NO-1NC)	1	NO	●			*ASN111									
	2	NC			●									*ASN211	
20 (2NO)	1	NO	●			ASN120-T									
	2	NO			●									ASN220-T	
22 (2NO-2NC)	1	NO	●			*ASN122									
	2	NO												*ASN222	
	3	NC	●												
	4	NC			●										
40 (4NO)	1	NO	●			ASN140-T									
	2	NO												ASN240-T	
	3	NO	●												
	4	NO			●										
22 (2NO-2NC)	1	NO	●			ASN15S ★									
	2	NO			●									ASN25S ★	
	3	NC		■											
	4	NC		■											
02 (2NC)	1	NC		■		ASN17S ★									
	2	NC		■										ASN27S ★	
04 (4NC)	1	NC		■		ASN18S ★									
	2	NC		■										ASN28S ★	
	3	NC		■											
	4	NC		■											
11 (1NO-1NC)	1	NO			●										
	2	NC	●											*ASN1011	*ASN2011
02 (2NC)	1	NC			●										
	2	NC	●											—	ASN2002-T
22 (2NO-2NC)	1	NO			●										
	2	NC	●											*ASN1022	*ASN2022
	3	NO			●										
	4	NC	●												
04 (4NC)	1	NC			●										
	2	NC	●											—	ASN2004-T
	3	NC			●										
	4	NC	●												
22 (2NO-2NC)	1	NO	●												
	2	NO			●									ASN105S ★	ASN205S ★
	3	NC		■											
	4	NC		■											
02 (2NC)	1	NC		■											
	2	NC		■										ASN107S ★	ASN20L7S ★
04 (4NC)	1	NC		■											
	2	NC		■										ASN108S ★	ASN208S ★
	3	NC		■											
	4	NC		■											







ASN-T are twin-rod units. Single rods are available for the same circuit (marked with *) but different contacts are used.

ø30 ø30 series Selector Switches

ASN□L Selector Switches (Lever Operator)

90° 2-position

Package Quantity: 1

Shape			ASN□L				 <ul style="list-style-type: none"> • Lever: Black • Round bezel (metal): Chrome-plated • Units marked with ★ and part numbers with "-T" differ in shape. See page 48 for dimensions. • Nameplates are ordered separately. 			
Contact Arrangement Chart										
Contact Code	Contact Block		Operator Position		Maintained	Spring Return from Right	Maintained	Spring Return from Left		
	Mounting Position	Contact	L	R						
10 (1NO)	1	NO		●	ASN3L10	ASN4L10	/	/		
	2	Dummy								
11 (1NO-1NC)	1	NO		●	ASN3L11	ASN4L11				
	2	NC	●							
20 (2NO)	1	NO	●	●	ASN3L20	ASN4L20				
	2	NO		●						
22 (2NO-2NC)	1	NO		●	ASN3L22	ASN4L22				
	2	NC	●							
	3	NO		●						
	4	NC	●							
7S (1NO-1NC)	1	NO	■		ASN3L7S (Note)	ASN4L7S (Note)				
	2	NC		■						
10 (1NO)	1	NO	●		/	/			ASN30L10	ASN40L10
	2	Dummy								
11 (1NO-1NC)	1	NO	●				ASN30L11	ASN40L11		
	2	NC		●						
20 (2NO)	1	NO	●				ASN30L20	ASN40L20		
	2	NO	●							
22 (2NO-2NC)	1	NO	●				ASN30L22	ASN40L22		
	2	NC		●						
	3	NO	●							
	4	NC		●						
7S (1NO-1NC)	1	NO	■				ASN30L7S (Note)	ASN40L7S (Note)		
	2	NC		■						



Note: The overlapping time is shorter for left to right than right to left. Take overlapping time into consideration.

ø30 Series Selector Switches ø30

ASN□L Selector Switches (Lever Operator)

45° 3-position

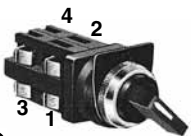
Package Quantity: 1

Shape			ASN□L				 <ul style="list-style-type: none"> Lever: Black Round bezel (metal): Chrome-plated Units marked with ★ and part numbers with "-T" differ in shape. See page 48 for dimensions. Nameplates are ordered separately. 				
Contact Arrangement Chart											
Contact Code	Contact Block		Operator Position			Maintained	Spring Return from Left	Maintained	Spring Return from Right		
	Mounting Position	Contact	L	R	C	L C R	L C R	L C R	L C R		
11 (1NO-1NC)	1	NO	●			*ASN111	*ASN211	/	/		
	2	NC			●						
20 (2NO)	1	NO	●			ASN120-T	ASN220-T				
	2	NO			●						
22 (2NO-2NC)	1	NO	●			*ASN1L22	*ASN2L22				
	2	NO			●						
	3	NC	●								
	4	NC			●						
40 (4NO)	1	NO	●			ASN1L40-T	ASN2L40-T				
	2	NO			●						
	3	NO	●								
	4	NO			●						
22 (2NO-2NC)	1	NO	●			ASN1L5S ★	ASN2L5S ★				
	2	NO			●						
	3	NC		■							
	4	NC		■							
02 (2NC)	1	NC		■		ASN1L7S ★	ASN2L7S ★				
	2	NC		■							
04 (4NC)	1	NC		■		ASN1L8S ★	ASN2L8S ★				
	2	NC		■							
	3	NC		■							
	4	NC		■							
11 (1NO-1NC)	1	NO			●	/	/			*ASN10L11	*ASN20L11
	2	NC	●							—	ASN20L02-T
02 (2NC)	1	NC	●					*ASN10L22	*ASN20L22		
	2	NC			●						
22 (2NO-2NC)	1	NO	●					—	ASN20L04-T		
	2	NO			●						
	3	NO	●								
	4	NC	●								
04 (4NC)	1	NC			●			ASN10L5S ★	ASN20L5S ★		
	2	NC	●								
	3	NC		■							
	4	NC		■							
22 (2NO-2NC)	1	NO	●					ASN10L7S ★	ASN20L7S ★		
	2	NO			●						
	3	NC		■							
	4	NC		■							
02 (2NC)	1	NC		■				ASN10L8S ★	ASN20L8S ★		
	2	NC		■							
04 (4NC)	1	NC		■				ASN10L8S ★	ASN20L8S ★		
	2	NC		■							
	3	NC		■							
	4	NC		■							



ASN□-T are twin-rod units. Single rods are available for the same circuit (marked with *) but different contacts are used.

ø30 ø30 series Selector Switches

ASN□K Key Selector Switches

90° 2-position

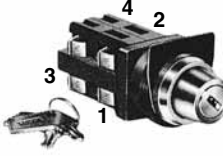
Package Quantity: 1

Shape Contact Arrangement Chart	ASNK  	<ul style="list-style-type: none"> • Cylinder: Chrome-plated • Round bezel (metal): Chrome-plated • On the spring-returned, the keys can be released only from the maintained position. On the maintained, the key can be released from every position. Key retained positions are also available. See page 21. • Key selector switch is supplied with two standard keys. Two different keys are available upon request. • Part numbers with "-T" differ in shape. • See page 48 for dimensions. • Nameplates are ordered separately.
--	--	--

Contact Code	Contact Block		Operator Position		Maintained	Spring Return from Right	Maintained	Spring Return from Left				
	Mounting Position	Contact	L	R	L R	L R	L R	L R				
10 (1NO)	1	NO		●	/	/	/	/				
	2	—	—	—								
11 (1NO-1NC)	2	NO		●								
	2	NC	●									
20 (2NO)	1	NO		●								
	2	NO		●								
22 (2NO-2NC)	1	NO		●								
	2	NC	●									
	3	NO		●								
	4	NC	●									
7S (1NO-1NC)	1	NO	■						ASN3K7S-T	ASN4K7S-T		
	2	NC	■						*ASN3K7S (Note)	*ASN4K7S (Note)		
10 (1NO)	1	NO	●		/	/	*ASN30K10	*ASN40K10				
	2	—	—	—			—	ASN40K01-T				
01 (1NC)	1	NC	●									
	2	—	—	—								
11 (1NO-1NC)	1	NO	●									
	2	NO		●								
20 (2NO)	1	NC	●									
	2	NC	●									
02 (2NC)	1	NC	●									
	2	NC	●									
22 (2NO-2NC)	1	NC	●									
	2	NO		●								
	3	NC	●									
	4	NO		●								
7S (1NO-1NC)	1	NO	■		*ASN30K7S (Note)	ASN40K7S-T	ASN40K7S-T	*ASN40K7S (Note)				
	2	NC	■			*ASN40K7S (Note)						



Note: The overlapping time is shorter for left to right than right to left. Take overlapping time into consideration.

ø30 Series Selector Switches ø30

ASNK Key Selector Switches

45° 3-position

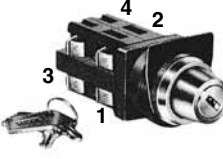
Package Quantity: 1

Shape		ASN□K		 <ul style="list-style-type: none"> • Cylinder: Chrome-plated • Round bezel (metal): Chrome-plated • On the spring-returned types, the keys can be released only from the maintained position. On the maintained types, the key can be released from every position. Key retained positions are also available. See page 21. • Key selector switch is supplied with two standard keys. Two different keys are available upon request. • See page 48 for dimensions. • Nameplates are ordered separately. 					
Contact Arrangement Chart									
Contact Code	Contact Block		Operator Position			Maintained	Spring Return from Left	Maintained	Spring Return from Right
	Mounting Position	Contact	L	C	R	L C R	L C R	L C R	L C R
11 (1NO-1NC)	1	NO	●			*ASN1K11	*ASN2K11	/	/
	2	NC			●				
20 (2NO)	1	NO	●			ASN1K20-T	ASN2K20-T		
	2	NO			●				
22 (2NO-2NC)	1	NO	●			*ASN1K22	*ASN2K22		
	2	NC			●				
	3	NO	●						
	4	NC			●				
40 (2NO)	1	NO	●			ASN1K40-T	ASN2K40-T		
	2	NO			●				
	3	NO	●						
	4	NO			●				
5S (2NO-2NC)	1	NO	●			*ASN1K5S	*ASN2K5S		
	2	NC			●				
	3	NO			■				
	4	NC			■				
5S (2NO-2NC)	1	NO	●			ASN1K5S-T	ASN2K5S-T		
	2	NO			●				
	3	NC			■				
	4	NC			■				
7S (2NC)	1	NO			■	*ASN1K7S	*ASN2K7S		
	2	NC			■				
7S (2NC)	1	NC			■	ASN1K7S-T	ASN2K7S-T		
	2	NC			■				
8S (4NC)	1	NO			■	*ASN1K8S	*ASN2K8S		
	2	NC			■				
	3	NO			■				
	4	NC			■				
8S (4NC)	1	NC			■	ASN1K8S-T	ASN2K8S-T		
	2	NC			■				
	3	NC			■				
	4	NC			■				
11 (1NO-1NC)	1	NO			●	/	/		
	2	NC	●					*ASN10K11	*ASN20K11
20 (2NC)	1	NC			●				ASN20K02-T
	2	NC	●						
22 (2NO-2NC)	1	NO			●			*ASN10K22	*ASN20K22
	2	NC	●						
	3	NO			●				
	4	NC	●						
04 (4NC)	1	NC			●				ASN20K04-T
	2	NC	●						
	3	NC			●				
	4	NC	●						
5S (2NO-2NC)	1	NO	●					*ASN10K5S	*ASN20K5S
	2	NC			●				
	3	NO			■				
	4	NC			■				
5S (2NO-2NC)	1	NO	●						ASN20K5S-T
	2	NO			●				
	3	NC			■				
	4	NC			■				
7S (2NC)	1	NO			■			*ASN10K7S	*ASN20K7S
	2	NC			■				
7S (2NC)	1	NC			■				ASN20K7S-T
	2	NC			■				
8S (4NC)	1	NO			■	*ASN10K8S	*ASN20K8S		
	2	NC			■				
	3	NO			■				
	4	NC			■				
8S (4NC)	1	NC			■		ASN20K8S-T		
	2	NC			■				
	3	NC			■				
	4	NC			■				

ASN-T are twin-rod units. Single rods are available for the same circuit (marked with *) but different contacts are used.

ø30 ø30 series Selector Switches

Dimensions

Knob Operator

Dimensions of knob operator marked with ★ or "-T" in the Part No.

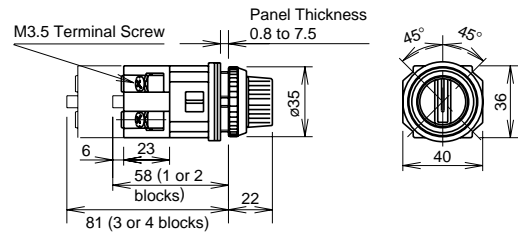
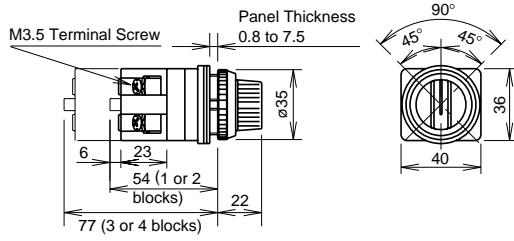

Lever Operator

Dimensions of lever operator marked with ★ or "-T" in the Part No.

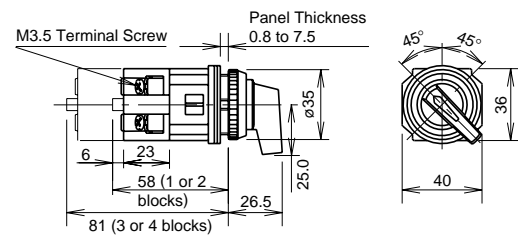
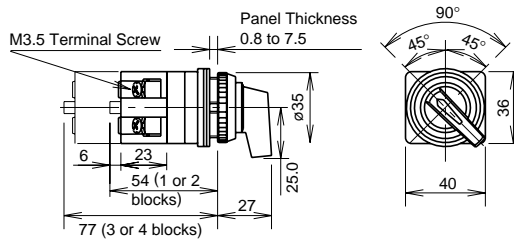

Key Selector

Dimensions of key selector switches marked with "-T" in the Part No.

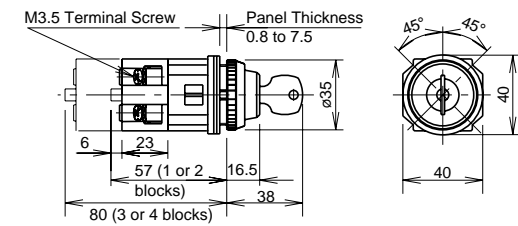
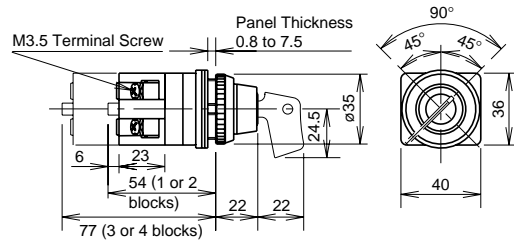

All dimensions in mm.

Contact Block Mounting Position and Contact Arrangement Chart

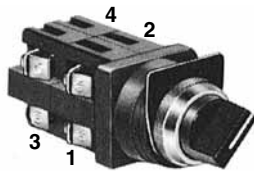









	Left	Center	Right	
	L	C	R	Operator position
1	NO	●		
2	NO		●	
3	NC		■	
4	NC	■		

ø30 Series Selector Switches ø30

ASTN Selector Switches (Knob Operator)

Package Quantity: 1

No. of Positions	Shape		ASTN		<ul style="list-style-type: none"> • Knob operator: Black • Round bezel (metal): Chrome-plated 					
	Contact Arrangement Chart									
90° 2-position	Contact Code	Contact Block		Operator Position		Maintained	Spring Return from Right	—	—	
		Mounting Position	Contact	L	R			—	—	
	11 (1NO-1NC)	1	NO		●	ASTN3211	ASTN4211	—	—	
		2	NC	●						
	22 (2NO-2NC)	1	NO		●	ASTN3222	ASTN4222	—	—	
		2	NO		●					
3		NC	●							
4		NC	●							
45° 3-position	Contact Code	Contact Block		Operator Position			Maintained	Spring Return from Left	Spring Return from Right	Spring Return Two-way
		Mounting Position	Contact	L	C	R				
	20 (2NO)	1	NO	●			—	—	—	ASTN5120
		2	NO			●				
	22 (2NO-2NC)	1	NO	●			ASTN1122	ASTN2122	ASTN20122	ASTN5122
		2	NO			●				
		3	NC			■				
		4	NC			■				
	22 (2NO-2NC)	1	NO	●		●	ASTN1222	ASTN2222	ASTN20222	ASTN5222
		2	NO			●				
		3	NC			●				
		4	NC			■				
	40 (4NC)	1	NO	●			ASTN1340	—	—	—
		2	NO			●				
		3	NO	●						
		4	NO			●				
	22 (2NO-2NC)	1	NO	●			ASTN1422	—	ASTN20422	—
		2	NC			■				
		3	NC			■				
		4	NO			●				
	20 (2NO)	1	NO	●			ASTN1520	—	ASTN20520	—
		2	NO			●				
	40 (4NO)	1	NO	●			ASTN1540	—	ASTN20540	—
		2	NO			●				
3		NO	●							
4		NO			●					
11 (1NO-1NC)	1	NC		●	●	ASTN1611	—	—	—	
	2	NO			●					
22 (2NO-2NC)	1	NC		●	●	ASTN1622	—	—	—	
	2	NO			●					
	3	NC			●					
	4	NO			●					
11 (1NO-1NC)	1	NO	●			—	—	—	ASTN5111	
	2	NC			■					

Notes:

1. The operator of the 2-way spring return unit may slightly deviate from the center position.
2. Turn the operator to each position accurately.

Contact Block Mounting Position and Contact Arrangement Chart



		Left	Center	Right	
		L	C	R	Operator Position
1	NO	●			
2	NO			●	
3	NC			■	
4	NC	■			



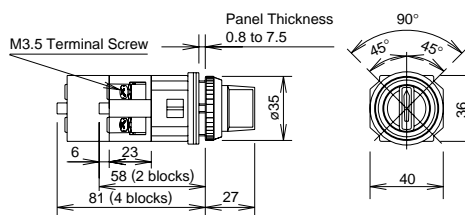





Dimensions



ø30 ø30 series Selector Switches

ASTN□L Selector Switches (Lever Operator)

Package Quantity: 1

No. of Positions	Shape		ASTN□L		<ul style="list-style-type: none"> Lever operator: Black Round bezel (metal): Chrome-plated 					
	Contact Arrangement Chart									
90° 2-position	Contact Code	Contact Block		Operator Position		Maintained	Spring Return from Right	—	—	
		Mounting Position	Contact	L	R			—	—	
	11 (1NO-1NC)	1	NO		●	ASTN32L11	ASTN42L11	—	—	
		2	NC	●						
	22 (2NO-2NC)	1	NO		●	ASTN32L22	ASTN42L22	—	—	
2		NO		●						
3		NC	●							
4	NC	●								
45° 3-position	Contact Code	Contact Block		Operator Position			Maintained	Spring Return from Left	Spring Return from Right	Spring Return Two-way
		Mounting Position	Contact	L	C	R				
	20 (2NO)	1	NO	●			—	—	—	ASTN51L20
		2	NO			●	—	—	—	—
	22 (2NO-2NC)	1	NO	●			ASTN11L22	ASTN21L22	ASTN201L22	ASTN51L22
		2	NO			●				
		3	NC			■				
		4	NC			■				
	22 (2NO-2NC)	1	NO	●			ASTN12L22	ASTN22L22	ASTN202L22	ASTN52L22
		2	NO			●				
		3	NC			■				
		4	NC			■				
	40 (4NC)	1	NO	●			ASTN13L40	—	—	—
		2	NO			●				
		3	NO	●						
		4	NO			●				
	22 (2NO-2NC)	1	NO	●			ASTN14L22	—	ASTN204L22	—
		2	NC			■				
		3	NC			■				
		4	NO			●				
20 (2NO)	1	NO	●			ASTN15L20	—	ASTN205L20	—	
	2	NO			●					
40 (4NO)	1	NO	●			ASTN15L40	—	ASTN205L40	—	
	2	NO			●					
	3	NO	●							
	4	NO			●					
11 (1NO-1NC)	1	NC			●	ASTN16L11	—	—	—	
	2	NO			●					
22 (2NO-2NC)	1	NC			●	ASTN16L22	—	—	—	
	2	NO			●					
	3	NC			■					
	4	NO			●					
11 (1NO-1NC)	1	NO	●			—	—	—	ASTN51L11	
	2	NC			■					

Notes:

- The operator of the 2-way spring return unit may slightly deviate from the center position.
- Turn the operator to each position accurately.

Contact Block Mounting Position and Contact Arrangement Chart



	Left	Center	Right	Operator Position
	L	C	R	
1	NO	●		
2	NO		●	
3	NC		■	
4	NC	■		

Dimensions

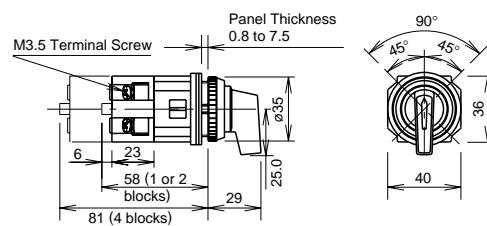

ø30 Series Selector Switches ø30

ASTN□K Key Selector Switches

Package Quantity: 1

No. of Positions	Shape		ASTNK							
	Contact Arrangement Chart									
90° 2-position	Contact Code (ASTN)	Contact Block		Operator Position			Maintained	Spring Return from Right	—	
		Mounting Position	Contact	L	R		L R	L R	—	
	11 (1NO-1NC)	1	NO	●	●		ASTN32K11	ASTN42K11	—	
		2	NC	●						
	22 (2NO-2NC)	1	NO		●	●	ASTN32K22	ASTN42K22	—	
		2	NO		●	●				
	3	NC	●							
	4	NC	●							
45° 3-position	Contact Code (ASTN)	Contact Block		Operator Position			Maintained	Spring Return from Left	Spring Return from Right	Spring Return Two-way
		Mounting Position	Contact	L	C	R	L C R	L C R	L C R	L C R
	20 (2NO)	1	NO	●			—	—	—	ASTN51K20
		2	NO			●				
	22 (2NO-2NC)	1	NO	●			ASTN11K22	ASTN21K22	ASTN201K22	ASTN51K22
		2	NO			●				
		3	NC			●				
		4	NC	■						
	22 (2NO-2NC)	1	NO	●			ASTN12K22	ASTN22K22	ASTN202K22	ASTN52K22
		2	NO			●				
		3	NC			●				
		4	NC	■						
	40 (4NC)	1	NO	●			ASTN13K40	—	—	—
		2	NO			●				
		3	NO	●						
		4	NO			●				
	22 (2NO-2NC)	1	NO	●			ASTN14K22	—	ASTN204K22	—
		2	NC			■				
		3	NC			■				
		4	NO			●				
	20 (2NO)	1	NO	●			ASTN15K20	—	ASTN205K20	—
		2	NO			●				
	40 (4NO)	1	NO	●			ASTN15K40	—	ASTN205K40	—
		2	NO			●				
		3	NO	●						
		4	NO	●						
11 (1NO-1NC)	1	NC		●	●	ASTN16K11	—	—	—	
	2	NO			●					
22 (2NO-2NC)	1	NC		●	●	ASTN16K22	—	—	—	
	2	NO			●					
	3	NC		●	●					
	4	NO			●					
11 (1NO-1NC)	1	NO	●			—	—	—	ASTN51K11	
	2	NC	■							



- Cylinder: Chrome-plated
- Round bezel (metal): Chrome-plated
- On the spring-returned, the keys can be released only from the maintained position.
- On the maintained, the key can be released from every position. Key retained positions are also available. See page 21.



Notes:

1. The operator of the 2-way spring return unit may slightly deviate from the center position.
2. Turn the operator to each position accurately.

Contact Block Mounting Position and Contact Arrangement Chart

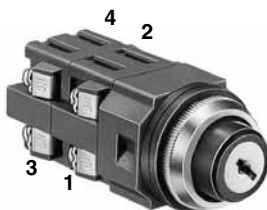

		Left	Center	Right	Operator Position
		L	C	R	
1	NO	●			
2	NO			●	
3	NC			■	
4	NC	■			

Dimensions

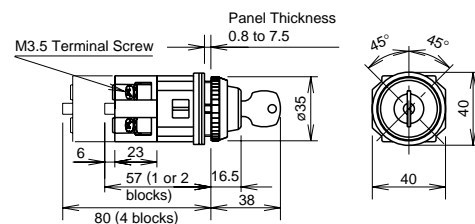



ø30 ø30 series Illuminated Selector Switches

ASLN Illuminated Selector Switches

90° 2-position

Package Quantity: 1

Shape		ASLN (Base BA9S)						
Contact Arrangement Chart								
								
Contact Code	Contact Block		Operator Position		Lamp	Maintained	Spring Return from Right	Spring Return from Left
	Mounting Position	Contact	L	R		L R	L R	L R
11 (1NO-1NC)	1	NO		●	Without Lamp	ASLN29911N②	ASLN219911N②	ASLN229911N② *
	2	NC	●		LED	ASLN2③11DN②	ASLN21③11DN②	ASLN22③11DN② *
					Incandescent	ASLN2③11N②	ASLN21③11N②	ASLN22③11N② *
20 (2NO)	1	NO		●	Without Lamp	ASLN29920N②	ASLN219920N②	ASLN229920N② *
	2	NO		●	LED	ASLN2③20DN②	ASLN21③20DN②	ASLN22③20DN② *
					Incandescent	ASLN2③20N②	ASLN21③20N②	ASLN22③20N② *
22 (2NO-2NC)	1	NO		●	Without Lamp	ASLN29922N②	ASLN219922N②	ASLN229922N② *
	2	NC	●					
	3	NO		●	LED	ASLN2③22DN②	ASLN21③22DN②	ASLN22③22DN② *
	4	NC	●					
				Incandescent	ASLN2③22N②	ASLN21③22N②	ASLN22③22N② *	

Color Code and Operating Voltage Code

Specify a code in place of ② or ③ in the Part No.

② Lens/LED Color Code		③ Operating Voltage Code		Input
LED	Incandescent	LED	Incandescent	
A: amber G: green R: red S: blue W: white Y: yellow	A: amber G: green R: red S: blue W: white	66: 6V AC/DC 11: 12V AC/DC 22: 24V AC/DC	66: 6V AC/DC 88: 12V AC/DC 33: 24V AC/DC	Full voltage
Use a pure white LED lamp for yellow illumination		16: 100/110V AC 136: 120V AC 26: 200/220V AC 256: 240V AC 386: 380V AC 46: 400/440V AC	16: 100/110V AC 136: 120V AC 26: 200/220V AC 256: 240V AC 386: 380V AC 46: 400/440V AC 486: 480V AC	Transformer

On the 2-position selector switches marked with * above, the contact operation is reversed as follows.

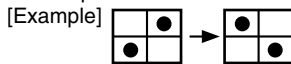

Contact Block Mounting Position and Contact Arrangement Chart

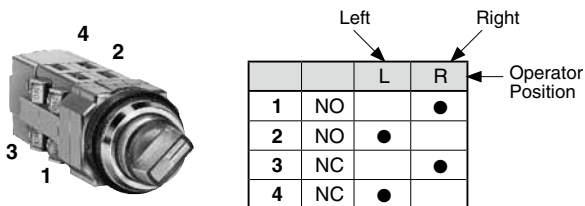

Dimensions

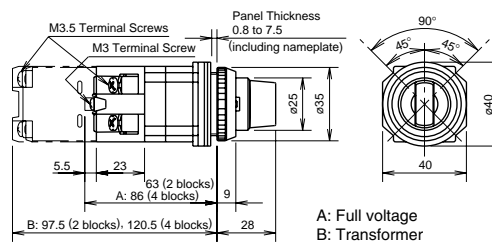

ø30 Series Illuminated Selector Switches ø30

ASLN Illuminated Selector Switches

45° 3-position

Package Quantity: 1

Contact Code	Contact Block		Operator Position			Lamp	Maintained	Spring Return from Right	Spring Return from left	Spring Return Two-way
	Mounting Position	Contact	L	C	R		L C R	L C R	L C R	L C R
20 (2NO)	1	NO	●			Without Lamp	ASLN39920N②	ASLN319920N②	ASLN329920N②	ASLN339920N②
	2	NO			●	LED	ASLN3③20DN②	ASLN31③20DN②	ASLN32③20DN②	ASLN33③20DN②
						Incandescent	ASLN3③20N②	ASLN31③20N②	ASLN32③20N②	ASLN33③20N②
02 (2NC)	1	NC		■		Without Lamp	ASLN39902N②	ASLN319902N②	ASLN329902N②	ASLN339902N②
	2	NC	■			LED	ASLN3③02DN②	ASLN31③02DN②	ASLN32③02DN②	ASLN33③02DN②
						Incandescent	ASLN3③02N②	ASLN31③02N②	ASLN32③02N②	ASLN33③02N②
22 (2NO-2NC)	1	NO	●			Without Lamp	ASLN39922N②	ASLN319922N②	ASLN329922N②	ASLN339922N②
	2	NO			●					
	3	NC		■		LED	ASLN3③22DN②	ASLN31③22DN②	ASLN32③22DN②	ASLN33③22DN②
	4	NC	■							
					Incandescent	ASLN3③22N②	ASLN31③22N②	ASLN32③22N②	ASLN33③22N②	
40 (4NO)	1	NO	●			Without Lamp	ASLN39940N②	ASLN319940N②	ASLN329940N②	ASLN339940N②
	2	NO			●					
	3	NO	●			LED	ASLN3③40DN②	ASLN31③40DN②	ASLN32③40DN②	ASLN33③40DN②
	4	NO			●					
					Incandescent	ASLN3③40N②	ASLN31③40N②	ASLN32③40N②	ASLN33③40N②	
04 (4NC)	1	NC		■		Without Lamp	ASLN39904N②	ASLN319904N②	ASLN329904N②	ASLN339904N②
	2	NC	■							
	3	NC		■		LED	ASLN3③04DN②	ASLN31③04DN②	ASLN32③04DN②	ASLN33③04DN②
	4	NC	■							
					Incandescent	ASLN3③04N②	ASLN31③04N②	ASLN32③04N②	ASLN33③04N②	

Color Code and Operating Voltage Code

Specify a code in place of ② or ③ in the Part No.

② Lens/LED Color Code		③ Operating Voltage Code		Input
LED	Incandescent	LED	Incandescent	
A: amber G: green R: red S: blue W: white Y: yellow	A: amber G: green R: red S: blue W: white	66: 6V AC/DC 11: 12V AC/DC 22: 24V AC/DC	66: 6V AC/DC 88: 12V AC/DC 33: 24V AC/DC	Full voltage
Use a pure white LED lamp for yellow illumination		16: 100/110V AC 136: 120V AC 26: 200/220V AC 256: 240V AC 386: 380V AC 46: 400/440V AC	16: 100/110V AC 136: 120V AC 26: 200/220V AC 256: 240V AC 386: 380V AC 46: 400/440V AC 486: 480V AC	Transformer

Contact Block Mounting Position and Contact Arrangement Chart

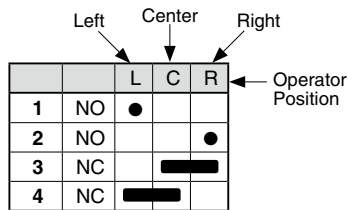
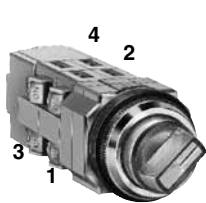

Dimensions

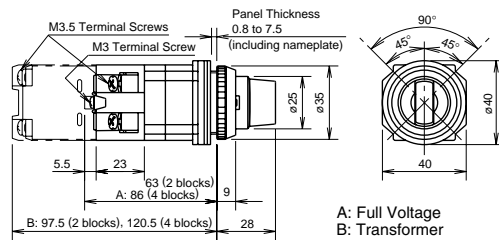

ø30 ø30 series Selector Pushbuttons

ABN Ring Operator / ABN□L Lever Operator Selector Pushbuttons

Package Quantity: 1

Shape	Contact Code	Circuit Code	Contact Block		Ring/Lever				Ring Operator	Lever Operator	① Button Color Code		
					Pushbutton							Part No.	Part No.
					Mounting Position	Contact	Normal	Push	Normal	Push			
<p>Ring Operator (90° 2-position)</p> <p>M3.5 Terminal Screw Panel Thickness 0.8 to 7.5 (including nameplate)</p> <p>Lever Operator (90° 2-position)</p> <p>M3.5 Terminal Screw Panel Thickness 0.8 to 7.5 (including nameplate)</p>	11 (1NO-1NC)	A	1	NO		●		●	ABN6111①	ABN6L111①	B: black G: green R: red Y: yellow		
			2	NC	●			●	ABN6411①	ABN6L411①			
		I	1	NC	●			■		ABN6411①		ABN6L411①	
			2	NO		●	■			ABN9111①		ABN9L111①	
		G	1	NO		●	Blocked		●	ABN9111①		ABN9L111①	
			2	NC	●			●		ABN7120①			
	20 (2NO)	D	1	NO		●			ABN7120①				
			2	NO				●					
	<p>Lever Operator (90° 2-position)</p> <p>M3.5 Terminal Screw Panel Thickness 0.8 to 7.5 (including nameplate)</p>	22 (2NO-2NC)	B	1	NC	●				ABN6122①		ABN6L122①	
				2	NC	●						ABN6122①	ABN6L122①
				3	NO		●		●			ABN6222①	ABN6L222①
				4	NO		●		●			ABN6222①	ABN6L222①
			C	1	NC	●						ABN6222①	ABN6L222①
				2	NC	●		■				ABN6222①	ABN6L222①
				3	NO		●		●			ABN6222①	ABN6L222①
				4	NO		●		●			ABN6222①	ABN6L222①
I			1	NC	●					ABN6422①	ABN6L422①		
			2	NC	●					ABN6422①	ABN6L422①		
			3	NO		●	■			ABN6422①	ABN6L422①		
			4	NO		●	■			ABN6422①	ABN6L422①		
D		1	NC	●			■		ABN7122①	ABN7L122①			
		2	NC	●		■			ABN7122①	ABN7L122①			
		3	NO		●		●		ABN7122①	ABN7L122①			
		4	NO		●		●		ABN7122①	ABN7L122①			
E		1	NC	●			■		ABN7222①	ABN7L222①			
		2	NC	●		■			ABN7222①	ABN7L222①			
		3	NO		●				ABN7222①	ABN7L222①			
		4	NO		●			●	ABN7222①	ABN7L222①			
F		1	NC	●			●		ABN7322①	ABN7L322①			
		2	NC	●					ABN7322①	ABN7L322①			
		3	NO		●				ABN7322①	ABN7L322①			
		4	NO		●			●	ABN7322①	ABN7L322①			
H	1	NC	●			●		ABN9122①	ABN9L122①				
	2	NC	●			●		ABN9122①	ABN9L122①				
	3	NO		●	Blocked		●	ABN9122①	ABN9L122①				
	4	NO		●	Blocked		●	ABN9122①	ABN9L122①				

- Specify a button color code in place of ① in the Part No.
- Ring/Lever (metal): Chrome-plated

Notes

1. Circuit Codes A, B, C, and I: When the ring or lever operator is turned, the button is pushed in.
2. Circuit Codes E and F: The right and left NC contact blocks on circuit code E or F may overlap each other while turning the ring or lever operator. The NO and NC contact blocks on circuit code F may overlap each other while pressing the button.
3. Circuit Codes G and H: The pushbutton does not operate when the ring or lever operator is turned to the left position.
4. When using the selector pushbutton, do not turn the ring or lever operator with the pushbutton depressed. Otherwise, damage or failure may be caused.

Contact Block Mounting Position and Contact Arrangement Chart

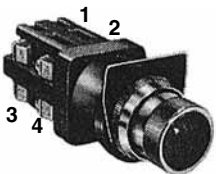

	Normal	Push
1	●	
2	●	
3		●
4		●

Mounting Hole Layout

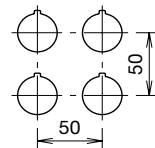



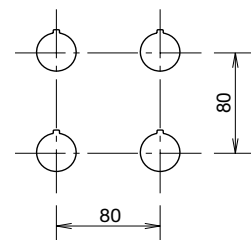





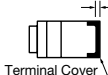

Ring Operator



Lever Operator

ø30 Series Accessories and Replacement Parts ø30

Terminal Covers

Terminal Cover		N-VL2	N-VL3	N-VL4	APN-PVL	APD-PVL	Use of terminal covers increases the depth by the dimensions below. 
		 38.4H × 22W	 38H × 30.4W	 38.4H × 24W	 38H × 46W	 37H × 44W	
ø30 Series Switches & Pilot Lights							
Pilot Light APN, APNE, UPQN, UPQNE	Full Voltage				X		+5.0 mm
Pilot Light APD, APDE							X
Pilot Light APN, APNE, APD, APDE, UPQN, UPQNE	Transformer DC-DC Converter		X				+2.7 mm
Pushbutton ABN, ABD, AON, AOD, AVN, ABGD, AJN, ABFD, ATN, AOFD, UBQN, AVD, UOQN, AJD, UWQN, AZD, ABBN, AYD, ABBS (ø25) Selector Switch ASN, ASD, ASTN Selector Pushbutton ABN, ASBD	1 contact block 	X					+0 mm
	2 contact blocks 	X 2 pieces					
	3 contact blocks 	X 2 pieces					
	4 contact blocks 	X 2 pieces					
Illuminated Pushbutton ALN, ALD, ALNE, ALDE, AOLN, AOLD, AOLNE, AOLDE, ALGN, ALGD, ALGNE, ALGDE, AOLGN, AOLGDE, ALFN, ALFD, ALFNE, ALFDE, AOLFN, AOLFD, AOLFNE, AOLFDE, AVLN, AVLD, AVLNE, AVLDE, AJLN, AJLD, AJLNE, AJLDE, ULQN, UOLQN Illuminated Selector Switch ASLN, ASLD Push-to-Check Pilot Light APN1**P	Full Voltage			X 2 pieces			+4.5 mm
	Transformer DC-DC Converter		X				+1.5 mm

Ordering Terminal Covers

- When ordering terminal covers, specify the Part No. and the quantity.

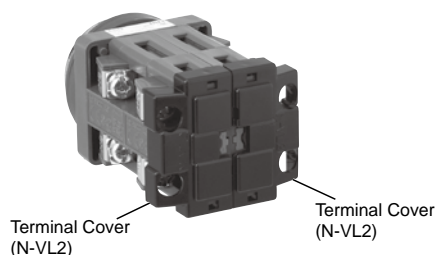

ø30 ø30 series Accessories and Replacement Parts

Nameplates

Model	Legend	Material	Part No.	Ordering No.	Package Quantity	Dimensions (mm)	Applicable Unit			
NA	Blank	Aluminium 1.2 mm thick White letters on black background	NA-0	NA-0	1		ø30 switches & pilot lights			
				NA-0PN10	10					
	With Legend		NA-*	1						
			NA-*PN10	10						
NALO	Blank	Aluminium 1.2 mm thick Black	NALO	NALO	1					
				NALOPN10	10					
MLO	Blank		Brass (chrome-plated) 1.0 mm thick Matte	MLO	MLO			1	<p>Letters should not be engraved within this line</p>	ARN/ARNS Mono-Lever
					MLOPN10			10		
CQ	Blank	Aluminium 0.5 mm thick White letters on black background		CQ-0	CQ-0	1	<ul style="list-style-type: none"> With adhesive tapes on the back 	UCSQO Cam Switch		
					CQ-0PN10	10				
	With Legend (Legend Codes 31 and 53 only)		CQ-*	1						
			CQ-*PN10	10						
CQM	Blank	Aluminium 0.5 mm thick White letters on black background	CQM-0	CQM-0	1	<ul style="list-style-type: none"> With adhesive tapes on the back 	UCSQM Cam Switch			
				CQM-0PN10	10					
	With Legend (Legend Code 31 only)		CQM-*	1						
			CQM-*PN10	10						

• Specify a legend code in place of * in the Ordering No.

ø30 Series Accessories and Replacement Parts ø30

Nameplates

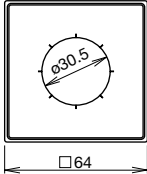
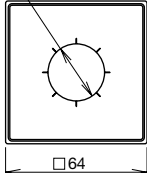
Model	Legend	Material	Part No.	Ordering No.	Package Quantity	Dimensions (mm)	Applicable Unit
CQN	Blank	Aluminium 0.5 mm thick White letters on black background	CQN-0	CQN-0	1	<ul style="list-style-type: none"> With adhesive tapes on the back 	ACSNO, ACSNK Cam Switches ø30 mm Selector Switches
				CQN-0PN10	10		
	With Legend (Legend Codes 31, 35, and 53 only)		CQN-*	CQN-*	1		
				CQN-*PN10	10		
CQS	Blank	Aluminium 0.5 mm thick White letters on black background	CQS-0	CQS-0	1	<ul style="list-style-type: none"> With adhesive tapes on the back 	ACSSO, ACSSK Cam Switches ø25 mm Selector Switches
				CQS-0PN10	10		
	With Legend (Legend Code 53 only)		CQS-*	CQS-*	1		
				CQS-*PN10	10		

• Specify a legend code in place of * in the Ordering No.

Legends

Code	Legend
0	(blank)
1	ON
2	OFF
3	START
4	STOP
31	OFF-ON
35	HAND-AUTO
53	HAND-OFF-AUTO

Shape and Engraving Area

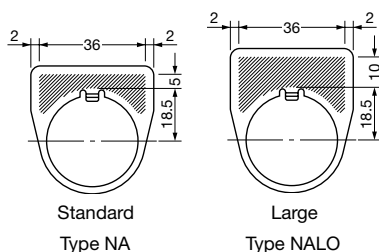











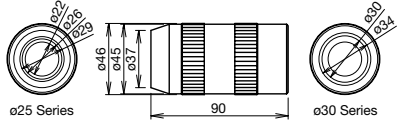

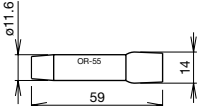

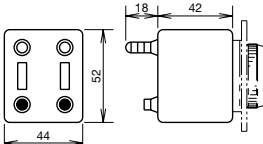
Example

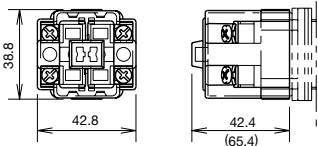
Shape	Engraving Area		Max. No. of Lines	No. of Letters on 1 Line
	Height	Width		
Standard	5	36	1	14
Large	10	36	2	14

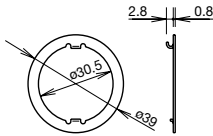
The above example is when the letter is 4 mm tall.

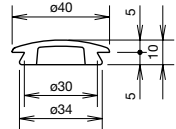

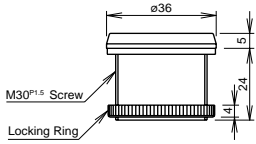

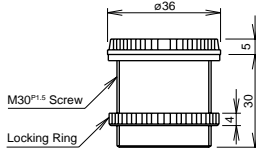



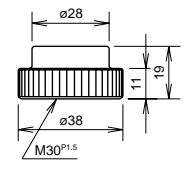

ø30 ø30 series Accessories and Replacement Parts

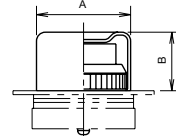
Accessories

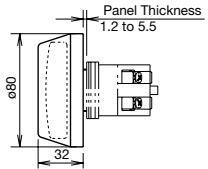
Shape	Material	Part No.	Ordering No.	Package Quantity	Dimensions (mm)
	Rubber	OR-12	OR-12	1	<ul style="list-style-type: none"> Used to tighten the locking ring when installing the ø30 or ø25 switch onto a panel. 
	Rubber	OR-55	OR-55	1	<ul style="list-style-type: none"> Used to install and remove the LED/incandescent lamps. See page 75. 
 <p>For momentary 1 layer of contact blocks (2 contact blocks)</p>	Rubber (nitril) (black)	OC-99	OC-99	1	<ul style="list-style-type: none"> Rubber boot used to prevent oil and dirt from entering into the contact block. Temperature range: -5 to +60°C Cannot be used for zinc diecast switches & pilot lights. 
 <p>For 1 layer of contact blocks (2 contact blocks)</p> <p>For 2 layers of contact blocks (4 contact blocks)</p>	Rubber (translucent)	OC-90	OC-90	1	<ul style="list-style-type: none"> Applicable to AVN3 and AJN3. Applicable to ø30 diecast zinc pushbuttons and selector switches. 
		OC-290	OC-290	1	
	Metal	OGL-11	OGL-11PN10	10	<ul style="list-style-type: none"> Used to prevent the operator from turning. Generally used when using no nameplates on selector switches and selector pushbuttons. 
	Rubber (black)	OB-13B	OB-13BPN05	5	<ul style="list-style-type: none"> Used to plug unused ø30mm mounting holes. Gray also available. Ordering No.: OB-13PN05 
	Plastic (gray)	OBP-11	OBP-11	1	<ul style="list-style-type: none"> Tightening torque: 1.2 N·m. Degree of protection: IP65 
	Metal (diecast) (zinc-plated)	OB-11	OB-11	1	<ul style="list-style-type: none"> Tightening torque: 1.2 N·m. Degree of protection: IP65 

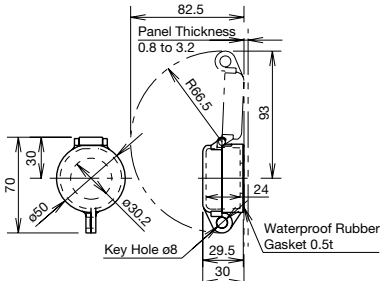

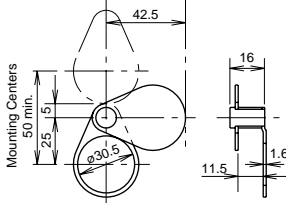

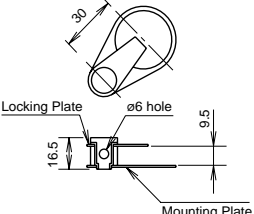



ø30 Series Accessories and Replacement Parts ø30

Accessories

Shape		Material	Part No.		Ordering No.	Package Quantity	Dimensions (mm)								
Button Cover for Extended Pushbuttons 		Rubber (nitril)	Color	Part No.	-	-	<ul style="list-style-type: none"> • Metallic bezels covered with a rubber boot to enhance waterproof characteristics. • Button is not included. Applicable to extended pushbuttons only. 								
			Black	OC-11B	OC-11B	1									
			Green	OC-11R	OC-11R	1									
			Red	OC-11G	OC-11G	1									
			Yellow	OC-11Y	OC-11Y	1									
Button Clear Boot 	For flush pushbuttons For extended pushbuttons	Rubber (EPDM)	OC-121	OC-121	1	<ul style="list-style-type: none"> • Used to cover and protect pushbuttons where units are subject to water splash. Not suitable for outdoor use or where the units are subject to oil splash.  <table border="1" style="margin-top: 10px; width: 100%; text-align: center;"> <thead> <tr> <th></th> <th>A</th> <th>B</th> </tr> </thead> <tbody> <tr> <td>OC-121</td> <td>37</td> <td>16</td> </tr> <tr> <td>OC-122</td> <td>37</td> <td>16</td> </tr> </tbody> </table>		A	B	OC-121	37	16	OC-122	37	16
	A	B													
OC-121	37	16													
OC-122	37	16													
			OC-122	OC-122	1										
Dust-proof Rubber Cover for Jumbo Mushroom 		Rubber (nitril) black	OC-4GN	OC-4GN	1	<ul style="list-style-type: none"> • Used for ABN4G pushbuttons. 									
Padlock Cover 		Polyarylate (gasket: nitril rubber)	OL-KL1	OL-KL1	1	<ul style="list-style-type: none"> • Used to protect pushbuttons, illuminated pushbuttons, and selector switches (knob operator). 									
Metal Protector 		Metal (zinc-plated)	OL-C	OL-C	1	<ul style="list-style-type: none"> • Used to protect flush pushbuttons from inadvertent operation. • Can be easily attached using the locking ring. 									
Locking Attachment 		Metal (zinc-plated)	OL-H	OL-H	1	<ul style="list-style-type: none"> • Used to lock an extended pushbutton in the depressed position. • Can be easily attached using the locking ring. 									





ø30 ø30 series Accessories and Replacement Parts

Maintenance Parts

Shape	Specification	Part No.	Ordering No.	Package Quantity	Remarks
Metallic Bezel 	Metal (zinc diecast: chrome-plated)	OG-11	OG-11PN02	2	<ul style="list-style-type: none"> Cannot be used with pin lock, selector pushbuttons, and mono-lever units.
Plastic Bezel 	Plastic (polycarbonate)	OGP-11*	OGP-11*PN02	2	<ul style="list-style-type: none"> Specify a color code in place of *. B (black), G (green), R (red), W (white), Y (yellow) Cannot be used with pin lock, selector pushbuttons, and mono-lever units.
Clear Plastic Bezel for Flush Pushbuttons 	Clear Plastic (acrylic)	OGP-13	OGP-13PN02	2	<ul style="list-style-type: none"> Clear plastic bezel and full shroud. OGP-1411 cannot be used with LED illumination units and diecast units.
Clear Plastic Bezel for Extended Pushbuttons 		OGP-14	OGP-14PN02	2	
Clear Plastic Bezel for Illuminated Pushbuttons 		OGP-1411	OGP-1411	1	
Metal Bezel for Illuminated Pushbuttons 	Metal (zinc diecast)	OL-11	OL-11PN05	5	
Clear Button Cover 	Clear Plastic (polycarbonate)	ABN1B-C	ABN1B-CPN05	5	<ul style="list-style-type: none"> Used on flush and extended pushbuttons to indicate a mark or a symbol engraved on the marking plate. The clear button cover holds the marking plate. The ø30 series marking chip can only be used on the ABN1 and AON1. Specify a color code in place of *. B (black), G (green), R (red), W (white), Y (yellow)
Marking Plate 	Plastic (polyacetal)	TN-0*	TN-0*PN10	10	

ø30 Series Accessories and Replacement Parts ø30

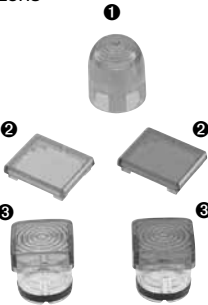
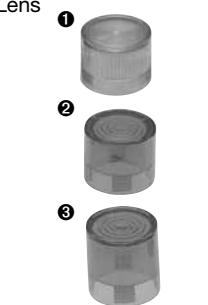

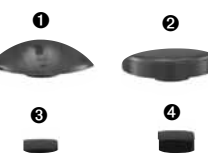





Maintenance Parts

Shape	Description	Material	Part No.	Ordering No.	Package Quantity	Color	
	1NO contact		BS010E	BS010E	1	<ul style="list-style-type: none"> • Push rod color: Green • -MAU has gold contacts 	
			BS010E-MAU	BS010E-MAU			
	1NC contact		BS001E	BS001E	1	<ul style="list-style-type: none"> • Push rod color: Red • -MAU has gold contacts 	
			BS001E-MAU	BS001E-MAU			
	EM contact (early make)		BS010SE	BS010SE	1	<ul style="list-style-type: none"> • Push rod color: Black • -MAU has gold contacts 	
			BS010SE-MAU	BS010SE-MAU			
	LB contact (late break)		BS001SE	BS001SE	1	<ul style="list-style-type: none"> • Push rod color: White • -MAU has gold contacts 	
			BS001SE-MAU	BS001SE-MAU			
	1NO contact		BST010	BST010	1	<ul style="list-style-type: none"> • Push rod color: Green • -MAU has gold contacts 	
			BST010-MAU	BST010-MAU			
	1NC contact		BST001	BST001	1	<ul style="list-style-type: none"> • Push rod color: Red 	
			BST001-MAU	BST001-MAU			
	EM contact (early make)		BST010S	BST010S	1	<ul style="list-style-type: none"> • Push rod color: Black 	
	LB contact (late break)		BST001S	BST001S	1	<ul style="list-style-type: none"> • Push rod color: White 	
		① Used for APN(E)1	Plastic	APN106LN-②	APN106LN-②PN05	5	<ul style="list-style-type: none"> A (amber), C (clear), G (green), R (red), S (blue), W (white), Y (yellow) • Use the white (W) lens for pure white illumination
		② Used for UPQNE4 U(O)LQN*B		UPQN406L-②	UPQN406L-②PN05	5	<ul style="list-style-type: none"> C (clear), G (green), R (red), S (blue) • Use the clear (C) lens for white illumination.
UPQN406LD-②				UPQN406LD-②PN05	<ul style="list-style-type: none"> A (amber), Y (yellow) • Use the amber (A) lens for orange illumination. 		
③ Used for UPQN3B U(O)LQN		ULQN06L-②		ULQN06L-②PN05	5	<ul style="list-style-type: none"> C (clear), G (green), R (red), S (blue) 	
		UPQN06LD-②		UPQN06LD-②PN05		<ul style="list-style-type: none"> A (amber), W (white), Y (yellow) • Use the amber (A) lens for orange illumination. 	
	① Used for ALN, AOLN (LED)	Plastic	ALN2L-②	ALN2L-②PN05	5	<ul style="list-style-type: none"> G (green), R (red), S (blue) 	
			ALN2LD-②	ALN2LD-②PN05	5	<ul style="list-style-type: none"> A (amber), W (white), Y (yellow) • Use the white (W) lens for pure white illumination 	
	② Used for ALN, AOLN (incandescent) (1W)		ALN06L-②	ALN06L-②PN05	5	<ul style="list-style-type: none"> C (clear), G (green), R (red), S (blue) 	
			ALN06LD-②	ALN06LD-②PN05	5	<ul style="list-style-type: none"> A (amber), W (white) • Use the amber (A) lens for orange illumination. 	
	③ Used for ALN, AOLN (incandescent) (2W)		ALN08L-②	ALN08L-②PN05	5	<ul style="list-style-type: none"> C (clear), G (green), R (red), S (blue) 	
			ALN08LD-②	ALN08LD-②PN05	5	<ul style="list-style-type: none"> A (amber), W (white) • Use the amber (A) lens for orange illumination. 	
	Flush	Plastic	ABN1B-①	ABN1B-①PN05	5	<ul style="list-style-type: none"> G (green), R (red), Y (yellow) Above colors are used for ø30 switches & pilot lights (dark colored operator units). For black, use black buttons from light colored operator units. 	
	Extended		ABN2B-①	ABN2B-①PN05	5		
	Mushroom		ABN3B-①	ABN3B-①PN02	2		
	Flush	Plastic	ABN1BN-①	ABN1BN-①PN05	5	<ul style="list-style-type: none"> B (black), G (green), R (red), S (blue), Y (yellow), W (white) Above colors are used for ø30 diecast zinc switches & pilot lights (light colored operator units). 	
	Extended		ABN2BN-①	ABN2BN-①PN05	5		
	Mushroom		ABN3BN-①	ABN3BN-①PN02	2		
	① Mushroom (ABN4)	Plastic	ABN4B-①	ABN4B-①	1	<ul style="list-style-type: none"> B (black), G (green), R (red), Y (yellow) 	
	② Mushroom (ABN4G/ABN4F)		ABN4GB-①	ABN4GB-①	1		
	③ Square Flush (UBQN1)		UBQN1B-①	UBQN1B-①PN02	2		
	④ Square Extended (UBQN2)		UBQN2B-①	UBQN2B-①PN02	2		

Note: Specify a button color code or lens color code in place of ① or ② in the Ordering No.





ø30 ø30 series Accessories and Replacement Parts

Maintenance Parts



Shape	Description	Material	Part No.	Ordering No.	Package Quantity	Remarks
Button 	For ø40 pushlock turn reset pushbuttons (for AVN3)	AS resin	AVN3B-②	AVN3B-②	1	R (red), Y (yellow)
Lens 	For ø40 pushlock turn reset pushbuttons (for AVLN3, AVLNE3)	AS resin	AVLN3L-R	AVLN3L-RPN02	2	Red only
Lens 	For ø40 pushlock turn reset pushbuttons (for AJN3)	AS resin	AJN3B-②	AJN3B-②	1	B (black), G (green), R (red), Y (yellow)
Lens 	For ø40 pushlock turn reset pushbuttons (for AJLN3)	AS resin	AJLN3L-②	AJLN3L-②	1	-G (green), -R (red), L-Y (yellow), L-A (amber), L-W (white)
Marking Plate 	For UPQN4	Plastic	UPQN406N-W	UPQN406N-WPN05	5	
Rubber Washer (3.0mm thick) 		Rubber	OW-12	OW-12PN10	10	
Rubber Washer (1.5mm thick) 		Rubber	OW-11	OW-11PN10	10	
Shroud 	① Half shroud (for pushbuttons)	Metal	ABN2G	ABN2G	1	
	② Full shroud (for pushbuttons)		ABN2F	ABN2F	1	
	③ Full shroud (for mushroom pushbuttons)		ABN3G	ABN3G	1	
	④ Shallow shroud (for jumbo mushrooms)		ABN4G	ABN4G	1	
	⑤ Deep shroud (for jumbo mushrooms)		ABN4F	ABN4F	1	
	⑥ Half shroud (for illuminated pushbuttons)		ALN1GL	ALN1GL	1	• For incandescent/LED illuminated pushbuttons (E12 base)
			ALN2GL	ALN2GL	1	• For LED illuminated pushbuttons (BA9S base)
	⑦ Full shroud (for illuminated pushbuttons)		ALN1F	ALN1F	1	• For incandescent/LED illuminated pushbuttons (E12 base)
	ALN2FL	ALN2FL	1	• For LED illuminated pushbuttons (BA9S base)		
Selector Knob 	Knob for illuminated selector switch	AS resin	ASLNH	ASLNH-*	1	G (green), R (red), S (blue)
			ASLNHD	ASLNHD-*		A (amber), W (white), Y (yellow)

ø30 Series Accessories and Replacement Parts ø30

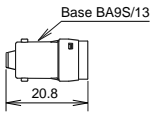

Maintenance Parts

Shape	Description	Material	Part No.	Ordering No.	Package Quantity	Remarks
	① ASN3K/4K, ABN5	Metal	ASN-T1SK-24401	ASN-T1SK-24401PN02	2	• Applicable to ABN3K, ABN4K, ABN5
	② ASN*K		ASN-SK-24401	ASN-SK-24401PN02		
	ASN□K□-T ASN*K		TW-SK-0	TW-SK-0PN02	2	
	100/110V AC (for LED/1W incandescent lamps)		TWR-016N	TWR-016N	1	Mounting screws are not included.
	200/220V AC (for LED/1W incandescent lamps)		TWR-026N	TWR-026N	1	
	For ABN8P pinlock	Metal	ABN8P-PIN	ABN8P-PIN	1	Pin, chain, and plate for ABN8P

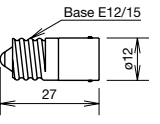
LED Lamps

Dimensions	Operating Voltage	Current Draw		Part No.	Ordering No.	② Illumination Color Code	Package Quantity	Base
		AC	DC					
 	6V AC/DC ±10%	8 mA	7 mA (A, R, W) 5.5 mA (G, PW, S)	LSTD-6②	LSTD-6②	A: amber G: green PW: pure white R: red S: blue W: white Use a pure white (PW) LED lamp with yellow (Y) lens.	1	BA9S/13
	12V AC/DC ±10%	11 mA	10 mA	LSTD-1②	LSTD-6②PN10		10	
					LSTD-1②		1	
	24V AC/DC ±10%	11 mA	10 mA	LSTD-2②	LSTD-1②PN10		10	
LSTD-2②					1			
 	6V AC/DC ±10%	17 mA (A, R, W, Y) 8 mA (G, PW, S)	14 mA (A, R, W, Y) 5.5 mA (G, PW, S)	LETD-6②	LETD-6②	A: amber G: green R: red S: blue W: white Y: yellow	1	E12/15
	12V AC/DC ±10%	7 mA	6.5 mA	LETD-8②	LETD-6②PN10		10	
					LETD-8②		1	
	24V AC/DC ±10%	11 mA	10 mA	LETD-2②	LETD-8②PN10		10	
LETD-2②					1			
				LETD-2②PN10	10			

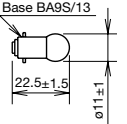

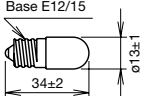
Incandescent Lamps

Dimensions	Rated Operating Voltage	Lamp Ratings	Part No.	Package Quantity	Life
 	6V AC/DC	1W (6.3V)	LS-6	1	Approx. 1000 hours minimum (reference value)
	12V AC/DC	1W (18V)	LS-8		
	18V AC/DC	1W (24V)	LS-2		
	24V AC/DC	1W (30V)	LS-3		
 	6V AC/DC	2W (6.3V)	LE-6	1	
	12V AC/DC	2W (18V)	LE-8		
	18V AC/DC	2W (24V)	LE-2		
	24V AC/DC	2W (30V)	LE-3		

• Specify a color code in place of ② in the Ordering No.

ø30 ø30 series Accessories and Replacement Parts

Transformer

DIN Rail Mount	Primary Voltage	Secondary Voltage	Part No.	Applicable Load
 For 1W	100/110V AC	5.5V	TWR516	One full voltage pilot light or illuminated switch containing LSTD-6②, LETD-6② LED lamp (6V AC/DC) or LS-6 incandescent lamp (6.3 V AC/DC, 1W)
	200/220V AC		TWR526	
	400/440V AC		TWR546	
 For 2W	100/110V AC	15V	TWR518	One full voltage pilot light or illuminated switch containing LE-8 incandescent lamp (18V AC/DC, 2W)
	200/220V AC		TWR528	
	400/440V AC		TWR548	

Specifications

Operating Voltage	100/110V AC, 115/120V AC, 200/220V AC, 230/240V AC, 380V AC, 400/440V AC, 480V AC (50/60Hz)
Current Draw	2.4 VA
Rated Insulation Voltage	600V
Insulation Resistance	100 MΩ minimum (500V DC megger)
Operating Temperature	-30 to +60°C (no freezing)
Storage Temperature	-40 to +80°C (no freezing)
Operating Humidity	35 to 85% RH (no condensation)
Vibration Resistance	Damage Limits: 30 Hz, amplitude 1.5 mm Operating extremes: 5 to 55 Hz, amplitude 0.5 mm
Shock Resistance	Damage limits, Operating Extremes: 1,000 m/s ²
Dielectric Strength	2,500V AC, 1 minute
Terminal Screw	M3.5
Applicable Wire	2 mm ² maximum, 2 wires maximum
Weight (approx.)	87g

Dimensions

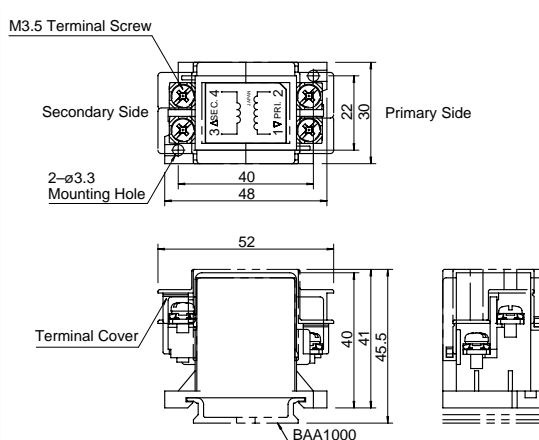

Accessories

DIN Rail

Part No.	Ordering No.	Length	Weight (approx.)	Material	Package Quantity
BAA1000	BAA1000PN10	1000 mm	200g	Aluminum	10
BAP1000	BAP1000PN10	1000 mm	320g	Steel	10

End Clip

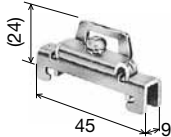
Part No.	Ordering No.	Applicable DIN Rail	Weight (approx.)	Material	Package Quantity	Dimensions
BNL6	BNL6PN10	BAA1000 BAP1000	15g	Steel (Zinc-plated)	10	 (24) 45 9

- Use plastic end clip BC9Z-E/NS35N when using 400/440V AC primary voltage transformers.

Safety Precautions

- Turn off the power to the ø30 series switches & pilot lights before starting installation, removal, wiring, maintenance, and inspection of the products. Failure to turn power off may cause electrical shocks or fire hazard.
- To avoid a burn on your hand, use the lamp holder tool when replacing lamps.
- For wiring, use wires of a proper size to meet the voltage and current requirements. Tighten the M3.5 terminal screws to a tightening torque of 1.0 to 1.3 N·m. Failure to tighten terminal screws may cause overheat and fire.

Instructions

Panel Mounting for Square Pushbuttons and Pilot Lights

1. Tighten the square ring to the operator and position the ring correctly.
2. Lightly tighten the screw to secure the pilot light onto the panel.

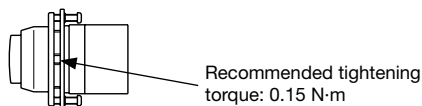

Tightening Torque for Terminal Screws

Tighten the terminal screws to a torque of 1.0 to 1.3 N·m.

Replacement of Lamps

Lamps can be replaced by using the lamp holder tool (OR-55) from the front of the panel.

How to Remove

To remove, slip the lamp holder tool onto the lamp head lightly. Then push slightly, and turn the lamp holder tool counterclockwise.

How to Install

To install, insert the lamp head into the lamp holder tool. Place the pins on the lamp base to the grooves in the lamp socket. Inset the lamp and turn it clockwise.



OR-55



Installing the Anti-rotation Ring

Anti-rotation rings are used on selector switches or pushbuttons which rotate and used when using no nameplates.

Insert a 1.5mm thick rubber washer between the panel and the anti-rotation ring as shown on the right.

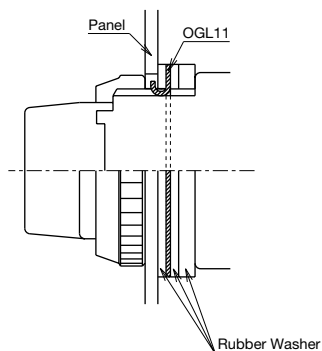

Panel Thickness and Rubber Washer

Adjust the thickness of the rubber washers according to the panel thickness. Also, make sure to include the nameplate thickness when using a nameplate.

Applicable Models

- Extended Illuminated Pushbuttons with Half Shroud (LED)
- Extended Pushbuttons with Half Shroud (Diecast)
- Extended Illuminated Pushbuttons with Half Shroud (Diecast)

Panel Thickness (mm)	Rubber Washer	
	1.5mm	3.0mm
Supplied	1 piece	1 piece
0.8 to 1.8	–	1 piece
1.8 to 3.5	1 piece	–

Applicable Models

- Extended Pushbuttons with Half Shroud
- Extended Illuminated Pushbuttons with Half Shroud (Incandescent)

Panel Thickness (mm)	Rubber Washer	
	1.5mm	3.0mm
Supplied	1 piece	1 piece
0.8	1 piece	1 piece
0.8 to 2.3	–	1 piece
2.3 to 4.0	1 piece	–

Applicable Models

- Extended Illuminated Pushbuttons with Full Shroud (Incandescent)
- Extended Illuminated Pushbuttons with Full Shroud (LED)
- Extended Illuminated Pushbuttons with Full Shroud (Diecast)
- Mushroom Pushbuttons with Full Shroud

Panel Thickness (mm)	Rubber Washer	
	1.5mm	3.0mm
Supplied	2 pieces	1 piece
0.8 to 2.0	1 piece	1 piece
2.0 to 3.5	1 piece	1 piece
3.5 to 5.0	–	1 piece
5.0 to 6.0 (6.5)	1 piece	–

The number in brackets is for mushroom pushbuttons with full shroud. Extended illuminated pushbuttons with full shroud (incandescent) are 5.0 mm maximum.

Applicable Models

- Toggle Lever
- Knob Push Turn Lock Illuminated Pushbuttons

Panel Thickness (mm)	Rubber Washer	
	1.5mm	3.0mm
Supplied	1 piece	1 piece
0.8 to 2.0	1 piece	1 piece
2.0 to 3.5	–	1 piece
3.5 to 5.5 (5.0)	1 piece	–

The number in brackets is for knob push turn lock illuminated pushbuttons.

Applicable Models

- Extended Pushbuttons with Full Shroud

Panel Thickness (mm)	Rubber Washer	
	1.5mm	3.0mm
Supplied	3 pieces	1 piece
0.8 to 1.5	3 pieces	1 piece
1.5 to 3.0	2 pieces	1 piece
3.0 to 4.5	1 piece	1 piece
4.5 to 6.0	–	1 piece
6.0 to 7.5	1 piece	–

Applicable Models

- Extended Pushbuttons with Full Shroud (Diecast)

Panel Thickness (mm)	Rubber Washer	
	1.5mm	3.0mm
Supplied	2 pieces	1 piece
0.8 to 2.5	2 pieces	1 piece
2.5 to 4.0	1 piece	1 piece
4.0 to 5.5	–	1 piece
5.5 to 6.0	1 piece	–

Applicable Models

- Other Models (Excluding Square)

Panel Thickness (mm)	Rubber Washer	
	1.5mm	3.0mm
Supplied	2 pieces	1 piece
0.8 to 3.5	2 pieces	1 piece
3.5 to 5.0	1 piece	1 piece
5.0 to 6.5	–	1 piece
6.5 to 7.5	1 piece	–

Installation of LED Illuminated Units

1. Note the polarity for wiring when connecting to DC-DC converter unit.

Terminal No.	Polarity
X1	Positive
X2	Negative

2. Transformer units are recommended for use in areas subjected to noise.

3. Notes for Pure White LED Lamps

- Do not use the pure white LED outdoors, otherwise it will lead to the degradation of brightness and color. Do not remove or apply shock to the cap on the pure white LED lamp, otherwise it may break or damage the cap.
- For the pure white LED, use a white lens. The illumination color will be dull if a different color is used.

Notes on LED Illuminated Units

LED lamps consist of semiconductors. If the applied voltage exceeds the rated voltage, LED elements may deteriorate due to overheat, resulting in significant decrease in luminance, hue change, or failure of lighting. Also, if an extraneous noise, transient voltage, or transient current is applied to the circuit, similar effects may occur. When using LED lamps, observe the following instructions.

Rated Voltage

The LED lamps are rated at 6V, 12V, or 24V AC/DC, and can be used within $\pm 10\%$ the rated voltage of either AC or DC.

DC Power

1. Switching power supply
Regulated voltage from switching power supply is best suited. Make sure to use within the rated voltage of the LED lamp.
2. Rechargeable battery
Note that the battery voltage may exceed the rated voltage of the LED lamp while the battery is being charged and immediately after the charging is complete. Be sure to use the LED lamp on a voltage of $\pm 10\%$ the rated voltage.
3. Full-wave rectification
Since the LED lamp is AC/DC compatible, a diode bridge for rectification is not necessary. If the LED lamp is used on a full-wave rectification current through a diode bridge, the rectifier diodes will reduce the voltage, resulting in lower luminance.
4. Single-phase half-wave rectification
This is not suitable for the power source of LED lamps. Use constant-voltage DC power.

Noise

LED elements deteriorate due to extraneous noise, resulting in significant decrease in luminance, hue change, or failure of lighting. When such effects are anticipated, take a protection measure shown below, such as RC elements or a surge absorber.

[Protection Example 1] For AC circuit

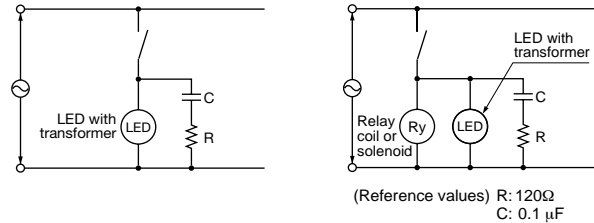

[Protection Example 2] For DC circuit

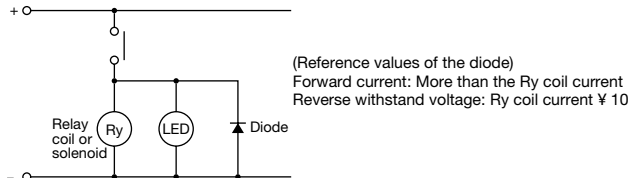

Countermeasures against Dim Lighting

1. Leakage currents through the transistors or a contact protection circuit may cause the LED lamp to illuminate dimly even when the output is off.
2. When the LED lamp is illuminated by a transistor output, take the following measure.

[Circuit Example]

Connect shunt resistor R in parallel with the LED lamp.

