

CÔNG TY CỔ PHẦN CÔNG NGHỆ HỢP LONG



*Think Automation and beyond...*

**ø25mm**

**TWS Series Switches & Pilot Lights**





















IDEC CORPORATION









**Hotline: 1900.6536 - Website: [HOPLONGTECH.COM](http://HOPLONGTECH.COM)**









# CÔNG TY CỔ PHẦN CÔNG NGHỆ HỢP LONG





## ø25 TWS Series (Selection Guide)





Function	Pushbutton				
Category	Flush	Extended	Extended with Half Shroud	Extended with Full Shroud	Mushroom
	Momentary/Maintained				
Shape	 	 	 	 	 
Model	ABS1 AOS1	ABS2 AOS2	ABGS2 AOGS2	ABFS2 AOFS2	ABS3 AOS3
Page	9	9	9	C-9	10

Function	Pushbutton			
Category	Mushroom with Full Shroud	Mushroom Pushlock Turn Reset	Mushroom Push Turn Lock	Mushroom Push-Pull
	Momentary/Maintained			
Shape	 	 	 	 
Model	ABGS3 AOGS3	AVS3	AJS3	AYS3
Page	10	10	10	11

Function	Pushbutton			
Category	Square Flush	Square Extended	Square Twin Momentary	Square Twin Maintained
	Momentary/Maintained			
Shape	 	 	 	 
Model	UBQS1 UOQS1	UBQS2	UWQN1	UWQN2
Page	11	11	12	12

Function	Pilot Light			
Category	Dome	Square (Marking) (Plastic Bezel)	Square (Marking) (Metal Bezel)	Dome Push-to-Check
Shape	 	 	 	 
Model	APS1	UPQS1B	UPQMS1B	APS1*PN
Page	13	13	13	13

Function	Illuminated Pushbutton			
Category	Extended (Non-marking)	Extended with Half Shroud (Non-marking)	Extended with Full Shroud (Non-marking)	Mushroom Pushlock Turn Reset
Shape				
Model	ALS2 AOLS2	ALGS2 AOLGS2	ALFS2 AOLFS2	AVLS3
Page	15	16	17	18

Function	Illuminated Pushbutton	Selector Switch			Illuminated Selector Switch
Category	Square Flush (Marking)	Knob	Lever	Key	Knob
Shape					
Model	ULQS1B UOLQS1B	ASS	ASS□L	ASS□K	ASLS
Page	19	21	22	23	24

INDUSTRIAL AUTOMATION

# ø25 TWS Series

## Highly reliable heavy-duty switches and pilot lights Suitable for industrial use

- HW-C contact blocks are used.
- Degree of protection: IP65 (IEC 60529)
- UL and CSA approved, EN and CCC compliant

Applicable Standards	Mark	File No. or Organization
UL508		UL Listing File No. E68961
CSA C22.2 No.14		CSA File No. LR21451
EN60947-1		TÜV Rheinland
		EU Low Voltage Directive
GB14048.5		CCC No. 2013010305611328 (Pilot light: 2013010304596127)



## Specifications and Ratings

### Contact Ratings

Contact Block	Rated Insulation Voltage	600V
	Rated Continuous Current	10A
	Contact Ratings by Utilization Category IEC 60947-5-1	AC-15 (A600) DC-13

### Characteristics

#### Contact Ratings by Utilization Category

Operational Voltage			24V	48V	50V	110V	220V	440V
Operational Current	AC 50/60 Hz	AC-12 Control of resistive loads and solid state loads	10A	—	10A	10A	6A	2A
		AC-15 Control of electromagnetic loads (> 72 VA)	10A	—	7A	5A	3A	1A
	DC	DC-12 Control of resistive loads and solid state loads	8A	4A	—	2.2A	1.1A	—
		DC-13 Control of electromagnets	4A	2A	—	1.1A	0.6A	—

Minimum applicable load: 3V AC/DC, 5 mA (applicable range may vary with operating conditions and load types)

For the units listed below, the rated current (load switching current) is reduced to a half of the rated operational current of the contact block. The rated insulation voltage (600V) and the rated thermal current (10A) remain unchanged.

- Selector switches and illuminated selector switches with contact code 2R, 3S, 4S, or 4R.

### HW-C (Contact Block)

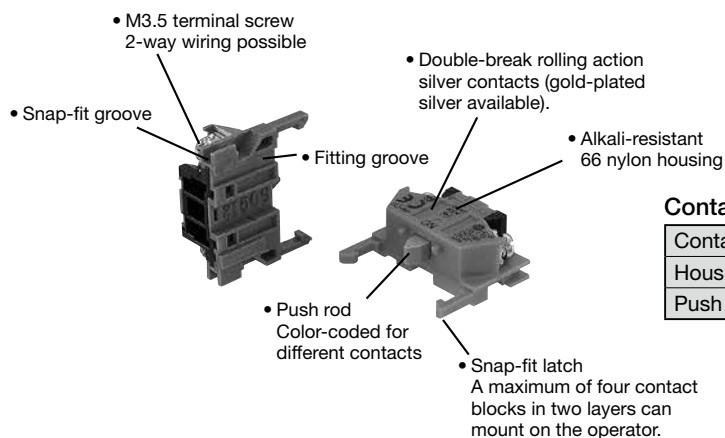

#### Contact Blocks

Contact	NO	NC	$\overline{\text{NO}}$ (early make)	$\overline{\text{NC}}$ (late break)
Housing	Blue	Purple red	Blue	Purple red
Push Rod	Green	Red	Black	White

Note: BS contact block is used for square twin pushbuttons UWQN1 and UWQN2.

### Specifications





Operating Temperature	-25 to +50°C (no freezing)
Storage Temperature	-40 to +80°C (no freezing)
Operating Humidity	45 to 85% RH (no condensation)
Contact Resistance	50 mΩ maximum (initial value)
Insulation Resistance	100 MΩ minimum (500V DC megger)
Dielectric Strength	Between live and dead metal parts: 2,500V AC, 1 minute (Full voltage illuminated units: 2,000V AC, 1 minute)
Vibration Resistance	Damage Limits: 30 Hz, amplitude 1.5 mm Operating extremes: 5 to 55 Hz, amplitude 0.5 mm
Shock Resistance	Damage limits: 1,000 m/s <sup>2</sup> Operating extremes: 100 m/s <sup>2</sup>
Mechanical Life (minimum operations)	Pushbuttons, Illuminated pushbuttons Momentary: 5,000,000 Others: 500,000 Pushlock turn reset: 250,000 Selector switches: 500,000 Key selector switches: 500,000 Illuminated selector switches: 500,000
Electrical Life (minimum operations)	Pushbuttons: 500,000 *1 Illuminated pushbuttons: 500,000 *1 Pushlock turn reset: 250,000 *1 Square twin maintained: 500,000 *2 Selector switches: 500,000 *3 Key selector switches: 500,000 *3 Illuminated selector switches: 250,000 *3 Others: 500,000 *1 *1 Switching frequency 1,800 operations/h, duty ratio 40% *2 Switching frequency 900 operations/h, duty ratio 40% *3 Switching frequency 1,200 operations/h, duty ratio 40%
Wegiht (approx.)	72g (ABS122N) 36g (APS122DN) 97g (ALS2222DN) 76g (ASS222N) 117g (ASS2K22N) 97g (ASLS2222DN)

### LED Illuminated Unit Specifications

Unit	Color Code ②	Input	Operating Voltage	LED Lamp			
				Lamp Base	Part No.	Voltage	
Pilot Light Illuminated Pushbutton Illuminated Selector Switch	A: amber G: green PW: pure white R: red S: blue W: white Y: yellow	Full Voltage	6V AC/DC	BA9S/13	LSTD-6②	6V AC/DC ±10%	
			12V AC/DC		LSTD-1②	12V AC/DC ±10%	
			24V AC/DC		LSTD-2②	24V AC/DC ±10%	
		Transformer	100/110V AC/DC 115/120V AC/DC 200/220V AC/DC 230/240V AC/DC 380V AC/DC 400/440V AC/DC (50/60 Hz)		LSTD-6②	6V AC/DC ±10%	
			DC-DC Converter		110V DC	LSTD-6②	6V AC/DC ±10%

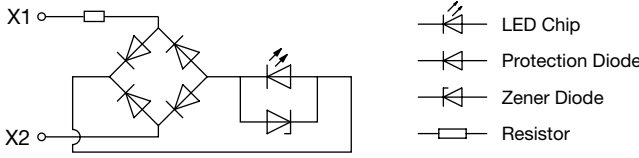
- Use a pure white (PW) LED for yellow illumination.

### LED Lamp Ratings (LSTD)

Part No.	LSTD-6②		LSTD-1②	LSTD-2②
Lamp Base	BA9S/13			
Rated Voltage	6V AC/DC		12V AC/DC	24V AC/DC
Voltage Range	6V AC/DC ±10%		12V AC/DC ±10%	24V AC/DC ±10%
Current Draw	AC	8 mA		11 mA
	DC	A, R, W: 7 mA, G, PW, S: 5.5 mA		10 mA
Color Code ②	A (amber), G (green), PW (pure white), R (red), S (blue), W (white)			
Lamp Base Color	Same as illumination color			
Voltage Marking	Die stamped on the base			
Life (reference value)	Approx. 50,000 hours (The luminance is reduced to 50% the initial intensity when used on complete DC.)			
Internal Circuit	 <p style="text-align: right;">  LED Chip   Protection Diode   Zener Diode   Resistor                 </p>			

### Mounting Hole Layout

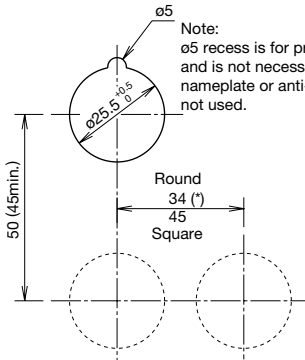

- \* The minimum mounting centers are applicable to switches with one layer of contact blocks (two contact blocks). When two layers of contact blocks are mounted, determine the minimum mounting centers in consideration of convenience for wiring.
- ø35mm mushroom: 35 mm minimum
  - Mushroom with shroud: 42 mm minimum
  - 2-position, 3-position lever selector switch: 42 mm minimum
  - 4-position, 5-position lever selector switch: 50 mm minimum

### Degree of Protection

Part No.	Unit	NEMA ICS 6-110	IEC 60529
A****	Pushbuttons, pilot lights, illuminated pushbuttons, and selector switches	Type 1, 2, 3, 3R, 4, 5, 12,13	IP65
	Illuminated selector switches and key selector switches	Type 1, 2, 3R, 5, 12, 13	IP54
U****	Square pushbuttons, square pilot lights, and square illuminated pushbuttons	Type 1, 2	IP40

### Ordering Information

#### Standard Units

- Specify an operator or lens color code in the Part No.
- Full voltage illuminated units are not supplied with a lamp. Order LED lamps separately. Transformer and DC-DC converter illuminated units contain an LED lamp.
- All standard units are UL, CSA, EN, and TÜV approved (except DC-DC converter).
- Terminal covers, nameplates, and accessories are ordered separately.

#### Terminal Cover

- When a terminal cover is required, order an applicable terminal cover referring to page 29.

The Part No. development charts shown below can be used to specify switches/pilot lights other than those listed on the following pages.

#### Pushbuttons

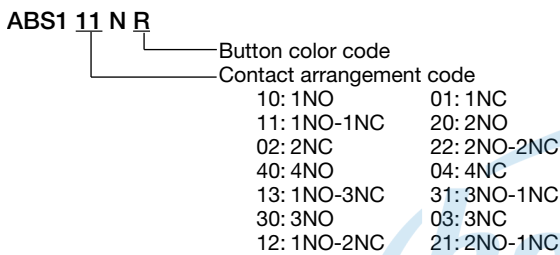

#### Illuminated Pushbuttons

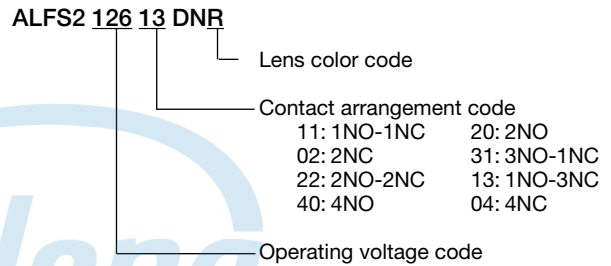

Note:

- Push-pull AYS3 can have a maximum of two contact blocks.

#### Pilot Lights

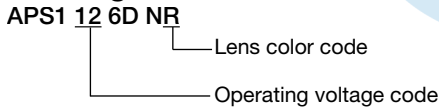

INDUSTRIAL AUTOMATION

### Selector Switch

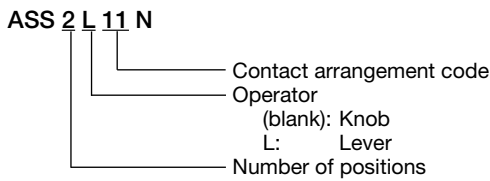

Note:

- See pages 26 to 28 for contact arrangement codes.

### Illuminated Selector Switch

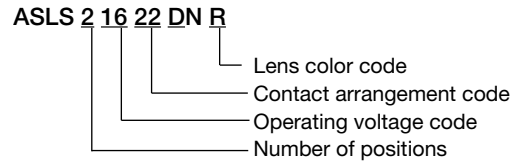

Note:

- See pages 26 to 28 for contact arrangement codes.

### Key Selector Switch

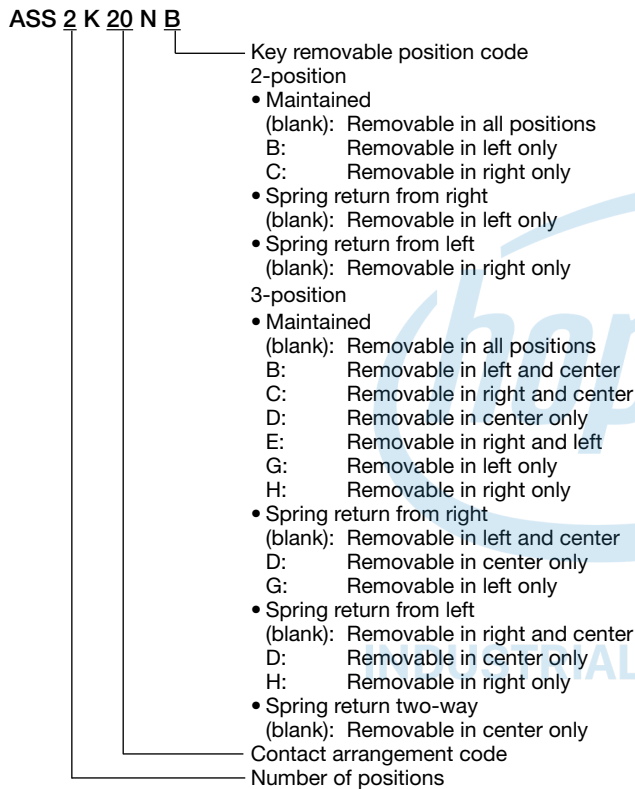









Note:

- See page 26 to 28 for contact arrangement codes.
- The key cannot be removed in the return position.

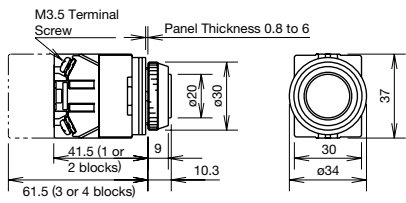

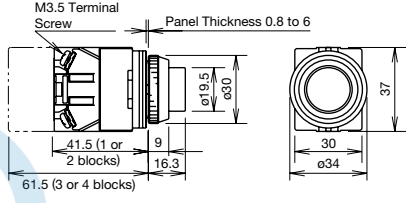
Flush / Extended Pushbuttons

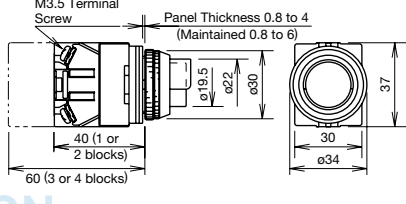

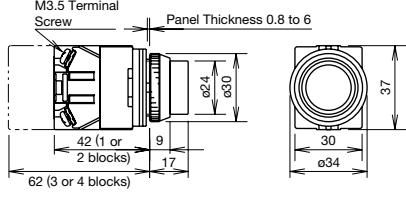





Package Quantity: 1

Shape	Operation	Contact	Part No.	① Button Color Code	Dimensions (mm)
Flush ABS1 AOS1    	Momentary	1NO	ABS110N①	Black (B), green (G), and red (R) buttons are supplied with each unit as standard.	 Note: The depth behind the panel of the maintained unit is 1.5mm longer than the momentary unit.
		1NC	ABS101N①		
		1NO-1NC	ABS111N①		
		2NO	ABS120N①		
		2NC	ABS102N①		
		2NO-2NC	ABS122N①		
	Maintained	1NO	AOS110N①	Specify S, W, or Y when a blue, white, or yellow button is required.	
		1NC	AOS101N①		
		1NO-1NC	AOS111N①		
		2NO	AOS120N①		
		2NC	AOS102N①		
		2NO-2NC	AOS122N①		
Extended ABS2 AOS2    	Momentary	1NO	ABS210N①	Specify a button color code in place of ① in the Part No.  B: black G: green R: red S: blue W: white Y: yellow	 Note: The depth behind the panel of the maintained unit is 1.5mm longer than the momentary unit.
		1NC	ABS201N①		
		1NO-1NC	ABS211N①		
		2NO	ABS220N①		
		2NC	ABS202N①		
		2NO-2NC	ABS222N①		
	Maintained	1NO	AOS210N①		
		1NC	AOS201N①		
		1NO-1NC	AOS211N①		
		2NO	AOS220N①		
		2NC	AOS202N①		
		2NO-2NC	AOS222N①		
Extended with Half Shroud ABGS2 AOGS2    	Momentary	1NO	ABGS210N①	Specify a button color code in place of ① in the Part No.  B: black G: green R: red S: blue W: white Y: yellow	 Note: The depth behind the panel of the maintained unit is 1.5mm longer than the momentary unit.
		1NC	ABGS201N①		
		1NO-1NC	ABGS211N①		
		2NO	ABGS220N①		
		2NC	ABGS202N①		
		2NO-2NC	ABGS222N①		
	Maintained	1NO	AOGS210N①		
		1NC	AOGS201N①		
		1NO-1NC	AOGS211N①		
		2NO	AOGS220N①		
		2NC	AOGS202N①		
		2NO-2NC	AOGS222N①		
Extended with Full Shroud ABFS2 AOFS2    	Momentary	1NO	ABFS210N①	Specify a button color code in place of ① in the Part No.  B: black G: green R: red S: blue W: white Y: yellow	 Note: The depth behind the panel of the maintained unit is 1.5mm longer than the momentary unit.
		1NC	ABFS201N①		
		1NO-1NC	ABFS211N①		
		2NO	ABFS220N①		
		2NC	ABFS202N①		
		2NO-2NC	ABFS222N①		
	Maintained	1NO	AOFS210N①		
		1NC	AOFS201N①		
		1NO-1NC	AOFS211N①		
		2NO	AOFS220N①		
		2NC	AOFS202N①		
		2NO-2NC	AOFS222N①		

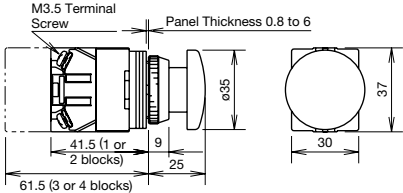
- Specify a button color code in place of ① in the Part No.
- Round bezel and shroud (metal): Chrome-plated
- Pushbuttons with one or three contact blocks contain a dummy block.
- Other contact arrangements are also available. See page 7.

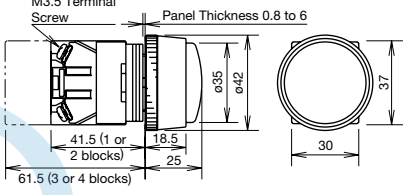
### Mushroom / Pushlock Turn Reset / Push Turn Lock Pushbuttons

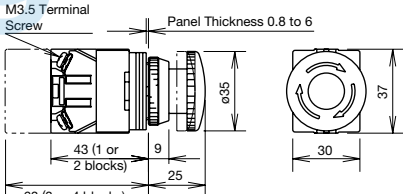
Package Quantity: 1

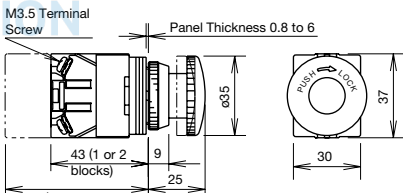
Shape	Operation	Contact	Part No.	① Button Color Code	Dimensions (mm)	
Mushroom ABS3 AOS3    	Momentary	1NO	ABS310N①	Specify a button color code in place of ① in the Part No.  B: black G: green R: red S: blue W: white Y: yellow		
		1NC	ABS301N①			
		1NO-1NC	ABS311N①			
		2NO	ABS320N①			
		2NC	ABS302N①			
	Maintained	2NO-2NC	ABS322N①			Note: The depth behind the panel of the maintained unit is 1.5mm longer than the momentary unit.
		1NO	AOS310N①			
		1NC	AOS301N①			
		1NO-1NC	AOS311N①			
		2NO	AOS320N①			
2NC	AOS302N①					
2NO-2NC	AOS322N①					
Mushroom with Full Shroud ABGS3 AOGS3    	Momentary	1NO	ABGS310N①	B: black G: green R: red S: blue W: white Y: yellow		
		1NC	ABGS301N①			
		1NO-1NC	ABGS311N①			
		2NO	ABGS320N①			
		2NC	ABGS302N①			
	Maintained	2NO-2NC	ABGS322N①			Note: The depth behind the panel of the maintained unit is 1.5mm longer than the momentary unit.
		1NO	AOGS310N①			
		1NC	AOGS301N①			
		1NO-1NC	AOGS311N①			
		2NO	AOGS320N①			
2NC	AOGS302N①					
2NO-2NC	AOGS322N①					
Pushlock Turn Reset AVS3    	Momentary	1NO	AVS310N①	R: red Y: yellow		
		1NC	AVS301N①			
		1NO-1NC	AVS311N①			
		2NO	AVS320N①			
		2NC	AVS302N①			
		2NO-2NC	AVS322N①			
Push Turn Lock AJS3    	Momentary	1NO	AJS310N①	B: black G: green R: red Y: yellow		
		1NC	AJS301N①			
		1NO-1NC	AJS311N①			
		2NO	AJS320N①			
		2NC	AJS302N①			
		2NO-2NC	AJS322N①			







- Specify a button color code in place of ① in the Part No.
- Round bezel (metal): Chrome-plated
- Pushbuttons with one or three contact blocks contain a dummy block.
- Other contact arrangements are also available. See page 7.
- Pushlock Turn Reset: Button is maintained when pressed and is reset when turned clockwise.

Note: AVS3 and AJS3 cannot be used as emergency stop switches. When emergency stop switches are required, use HW series emergency stop switches with HW9Z-A25 ring adapter (ISO 13850 and IEC 60947-5-5 compliant).

- Push Turn Lock: Button is locked when turned clockwise in the depressed position and is reset when turned counterclockwise.

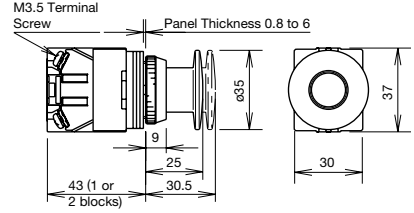
### Push-Pull / Square Flush / Square Extended Pushbuttons

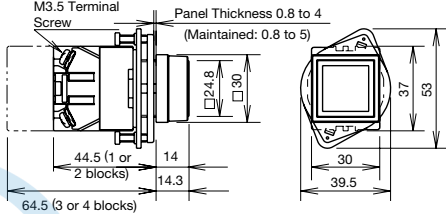

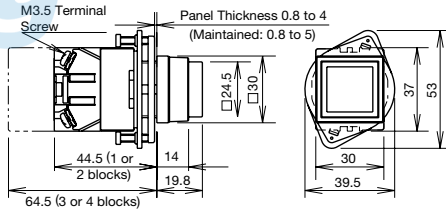







Package Quantity: 1

Shape	Operation	Contact	Part No.	① Button Color Code	Dimensions (mm)
Mushroom Push-Pull AYS31  	Maintained	1NO	AYS3110N①	B: black G: green R: red Y: yellow	
		1NC	AYS3101N①		
		1NO-1NC	AYS3111N①		
		2NO	AYS3120N①		
		2NC	AYS3102N①		
Square Flush UBQS1 UOQS1  	Momentary	1NO	UBQS110N①	B: black G: green R: red S: blue Y: yellow	
		1NC	UBQS101N①		
		1NO-1NC	UBQS111N①		
		2NO	UBQS120N①		
		2NC	UBQS102N①		
	Maintained	2NO-2NC	UBQS122N①		
		1NO	UOQS110N①		
		1NC	UOQS101N①		
		1NO-1NC	UOQS111N①		
Square Extended UBQS2  	Momentary	2NO	UOQS120N①	Note: The depth behind the panel of the maintained unit is 1.5mm longer than the momentary unit.	
		2NC	UOQS102N①		
		2NO-2NC	UOQS122N①		
		1NO	UBQS210N①		
		1NC	UBQS201N①		
		1NO-1NC	UBQS211N①		
2NO	UBQS220N①				
2NC	UBQS202N①				
2NO-2NC	UBQS222N①				

- Specify a button color code in place of ① in the Part No.
- Round bezel (metal): Chrome-plated
- Square bezel (plastic): Black
- Pushbuttons with one or three contact blocks contain a dummy block.
- Other contact arrangements are also available. See page 7
- Push-Pull:** Button is maintained in both depressed and reset positions. Up to 2 contact blocks (1 layer) can be mounted on AYS31 push-pull switches.

Note: AYS31 cannot be used as emergency stop switches. When emergency stop switches are required, use HW series emergency stop switches with HW9Z-A25 ring adapter (ISO 13850 and IEC 60947-5-5 compliant).

#### Contact Statuses of Push-Pull Switch

Contact	AYS31	
	Push	Pull
1NO		
1NC		
1NO-1NC		
2NO		
2NC		





Note: Push-pull switch can have a maximum of two contact blocks.

#### Panel Mounting of Square Pushbuttons

- Tighten the square bezel to the operator and position the ring correctly.
- Lightly tighten the screw to secure the pushbutton onto the panel.

### Square Twin Pushbuttons

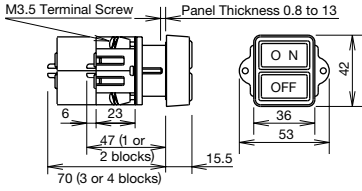
Package Quantity: 1

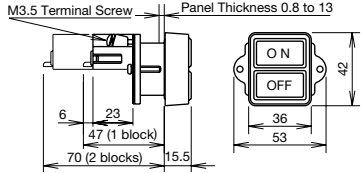
Shape	Contact		Part No.	Button Color	Dimensions (mm)
Square Twin (Momentary) UWQN1  	ON	OFF		ON: Black OFF: Red	
	1NO	1NO	UWQN11010		
	1NO	1NC	UWQN11001		
	2NO	2NC	UWQN12002		
Square Twin (Maintained) UWQN2  	1NO		UWQN21000	ON: Black OFF: Red	
	1NC		UWQN20100		
	1NO-1NC		UWQN21100		
	2NO		UWQN22000		
	2NC		UWQN20200		



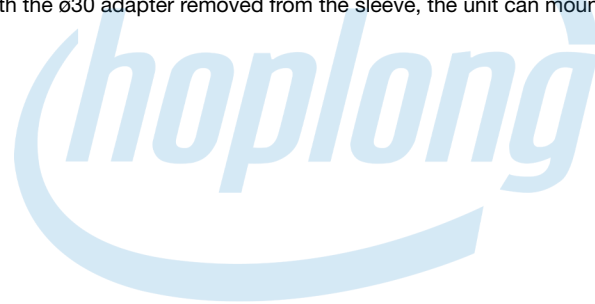



- **Square Twin (Momentary):** Two independent momentary switches are contained in one unit, each operated by ON or OFF button. With the ø30 adapter removed from the sleeve, the unit can mount in a ø25.5mm mounting hole for the ø25 series.
- **Square Twin (Maintained):** The contact operates when ON button is pressed and is maintained in the depressed position. The button is reset by pressing the OFF button. With the ø30 adapter removed from the sleeve, the unit can mount in a ø25.5mm mounting hole for the ø25 series.



INDUSTRIAL AUTOMATION

**Dome / Square / Rectangular (Marking) Pilot Lights**

Package Quantity: 1

Shape	Lamp	Part No.	②Lens/LED Color Code
Dome APS1  	Without Lamp	APS199②	NA: amber, NC: clear, NG: green, NR: red, NS: blue, NW: white, DNY: yellow
	LED	APS1③DN②	A: amber, G: green, PW: pure white, R: red, S: blue, W: white, Y: yellow
Square (Marking) UPQS1B (Plastic Bezel)  	Without Lamp	UPQS1B99②	NA: amber, NG: green, NR: red, NS: blue, NW: white, DNY: yellow
	LED	UPQS1B③DN②	A: amber, G: green, PW: pure white, R: red, S: blue, W: white, Y: yellow
Square (Marking) UPQMS1B (Metal Bezel)  	Without Lamp	UPQMS1B99②	NA: amber, NG: green, NR: red, NS: blue, NW: white, DNY: yellow
	LED	UPQMS1B③DN②	A: amber, G: green, PW: pure white, R: red, S: blue, W: white, Y: yellow

**Operating Voltage Code**

Specify an operating voltage code in place of ③ in the Part No.

③ Operating Voltage Code	Input
66: 6V AC/DC	Full Voltage
11: 12V AC/DC	
22: 24V AC/DC	
16: 100/110V AC	Transformer
126: 115/120V AC	
26: 200/220V AC	
246: 230/240V AC	
386: 380V AC	
46: 400/440V AC	
486: 480V AC	DC-DC Converter *
16D: 110V DC	

- Specify a color code in place of ② in the Part No.
- Round bezel (metal): Chrome-plated    Square bezel (plastic): Black    Square bezel (metal): Chrome-plated
- \* DC-DC converter types are not approved by UL, CSA, and TÜV, and not CE compliant (operating voltage 90 to 140V DC).

## ø25 TWS Series Pilot Lights

### Dimensions

Dome  
APS1

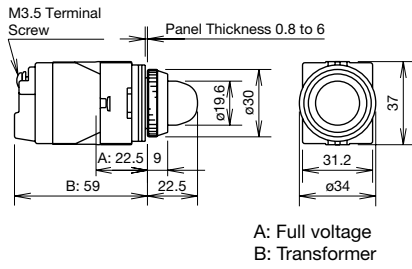

Square (Marking)  
UPQS1B (Plastic Bezel)

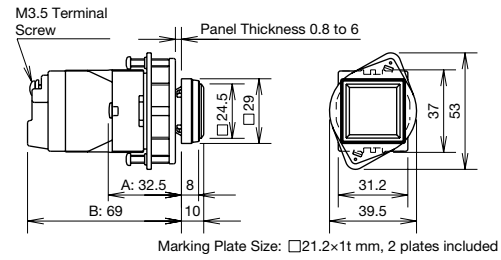

Square (Marking)  
UPQMS1B (Metal Bezel)

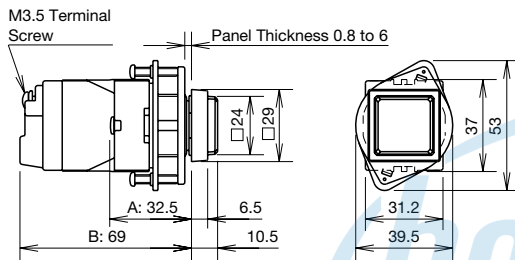

All dimensions in mm.

### Terminal Wiring (Bottom View)

Arrows indicate access directions for wiring.

Full Voltage

Transformer  
DC-DC Converter

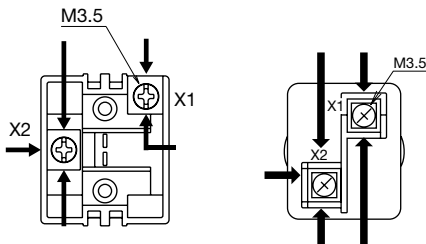

### Panel Mounting of Square and Rectangular Pilot Lights

1. Tighten the square or rectangular bezel to the operator and position the ring correctly.
2. Lightly tighten the screw to secure the pilot light onto the panel.

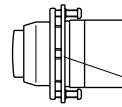



Tighten the screw lightly so that this plate does not bend.

Recommended tightening torque: 0.15 N·m

### Round Extended Illuminated Pushbuttons

Package Quantity: 1

Shape	Operation	Lamp	Contact	Part No.
Round Extended ALS2 AOLS2    	Momentary	Without Lamp	1NO-1NC	ALS29911 <sup>②</sup>
			2NO	ALS29920 <sup>②</sup>
			2NO-2NC	ALS29922 <sup>②</sup>
		LED	1NO-1NC	ALS2 <sup>③</sup> 11DN <sup>②</sup>
			2NO	ALS2 <sup>③</sup> 20DN <sup>②</sup>
			2NO-2NC	ALS2 <sup>③</sup> 22DN <sup>②</sup>
			1NO-1NC	ALS21611DDN <sup>②</sup> (Note)
			2NO	ALS21620DDN <sup>②</sup> (Note)
			2NO-2NC	ALS21622DDN <sup>②</sup> (Note)
	Maintained	Without Lamp	1NO-1NC	AOLS29911 <sup>②</sup>
			2NO	AOLS29920 <sup>②</sup>
			2NO-2NC	AOLS29922 <sup>②</sup>
		LED	1NO-1NC	AOLS2 <sup>③</sup> 11DN <sup>②</sup>
			2NO	AOLS2 <sup>③</sup> 20DN <sup>②</sup>
			2NO-2NC	AOLS2 <sup>③</sup> 22DN <sup>②</sup>
			1NO-1NC	AOLS21611DDN <sup>②</sup> (Note)
			2NO	AOLS21620DDN <sup>②</sup> (Note)
			2NO-2NC	AOLS21622DDN <sup>②</sup> (Note)

Note: DC-DC converter types.

#### Designation Code

Specify a code in place of ② or ③ in the Part No.

② Lens/LED Color Code		③ Operating Voltage Code	Input
Without Lamp	LED		
Specify a lens color code in place of ②.  NA: amber NC: clear NG: green NR: red NS: blue NW: white DNY: yellow	Specify a lens/LED color code in place of ②.  A: amber G: green PW: pure white R: red S: blue W: white Y: yellow  A pure white LED lamp is used for yellow illumination.	66: 6V AC/DC 11: 12V AC/DC 22: 24V AC/DC 16: 100/110V AC 126: 115/120V AC 26: 200/220V AC 246: 230/240V AC 386: 380V AC 46: 400/440V AC 486: 480V AC 16□□D: 110V DC	Full Voltage          Transformer       DC-DC Converter *



- Round bezel (metal): Chrome-plated
- Other contact arrangements are also available. See page 7.
- \* DC-DC converter types are not approved by UL, CSA, and TÜV, and not CE compliant (operating voltage 90 to 140V DC).





### Round Extended with Full Shroud Illuminated Pushbuttons

Package Quantity: 1

Shape	Operation	Lamp	Contact	Part No.
Round Extended with Full Shroud ALFS2 AOLFS2    	Momentary	Without Lamp	1NO-1NC	ALFS29911②
			2NO	ALFS29920②
			2NO-2NC	ALFS29922②
		LED	1NO-1NC	ALFS2③11DN②
			2NO	ALFS2③20DN②
			2NO-2NC	ALFS2③22DN②
			1NO-1NC	ALFS21611DDN② (Note)
			2NO	ALFS21620DDN② (Note)
			2NO-2NC	ALFS21622DDN② (Note)
	Maintained	Without Lamp	1NO-1NC	AOLFS29911②
			2NO	AOLFS29920②
			2NO-2NC	AOLFS29922②
		LED	1NO-1NC	AOLFS2③11DN②
			2NO	AOLFS2③20DN②
			2NO-2NC	AOLFS2③22DN②
			1NO-1NC	AOLFS21611DDN② (Note)
			2NO	AOLFS21620DDN② (Note)
			2NO-2NC	AOLFS21622DDN② (Note)

Note: DC-DC converter types.

#### Designation Code

Specify a code in place of ② or ③ in the Part No.

② Lens/LED Color Code		③ Operating Voltage Code	Input
Without Lamp	LED		
Specify a lens color code in place of ②.  NA: amber NC: clear NG: green NR: red NS: blue NW: white DNY: yellow	Specify a lens/LED color code in place of ②.  A: amber G: green PW: pure white R: red S: blue W: white Y: yellow  A pure white LED lamp is used for yellow illumination.	66: 6V AC/DC 11: 12V AC/DC 22: 24V AC/DC 16: 100/110V AC 126: 115/120V AC 26: 200/220V AC 246: 230/240V AC 386: 380V AC 46: 400/440V AC 486: 480V AC 16□□D: 110V DC	Full Voltage          Transformer       DC-DC Converter *





• Round bezel (metal): Chrome-plated

• Other contact arrangements are also available. See page 7.

\* DC-DC converter types are not approved by UL, CSA, and TÜV, and not CE compliant (operating voltage 90 to 140V DC).

### Mushroom / Mushroom Pushlock Turn Reset Illuminated Pushbuttons

Package Quantity: 1

Shape	Operation	Lamp	Contact	Part No.		
Mushroom Pushlock Turn Reset AVLS3      		Without Lamp	1NO-1NC	AVLS39911NR		
			2NO	AVLS39920NR		
			2NO-2NC	AVLS39922NR		
		LED			1NO-1NC	AVLS3③11DNR
					2NO	AVLS3③20DNR
					2NO-2NC	AVLS3③22DNR

#### Designation Code

Specify a code in place of ② or ③ in the Part No.





② Lens Color Code	③ Operating Voltage Code	Input
Specify a lens color code in place of ②.  A: amber G: green R: red S: blue W: white	66: 6V AC/DC	Full Voltage
	11: 12V AC/DC	
	22: 24V AC/DC	
	16: 100/110V AC	Transformer
	126: 115/120V AC	
	26: 200/220V AC	
	246: 230/240V AC	
	386: 380V AC	
	46: 400/440V AC	
	486: 480V AC	

- Round bezel (metal): Chrome-plated
- Other contact arrangements are also available. See page 7.
- **Pushlock Turn Reset:** Lens is maintained when pressed and is reset when turned clockwise. Red lens only.
- Note: AVLS3 pushlock turn reset switches cannot be used as emergency stop switches that meet the requirement of international safety standards ISO 13850 and IEC 60947-5-5 compliant. When such emergency stop switches are required, use ø22mm HW series/XW series.

INDUSTRIAL AUTOMATION

### Square Flush Illuminated Pushbuttons

Package Quantity: 1

Shape	Operation	Lamp	Contact	Part No.
Square Flush (Marking) ULQS1B UOLQS1B       	Momentary	Without Lamp	1NO-1NC	ULQS1B9911②
			2NO	ULQS1B9920②
			2NO-2NC	ULQS1B9922②
		LED	1NO-1NC	ULQS1B③11DN②
			2NO	ULQS1B③20DN②
			2NO-2NC	ULQS1B③22DN②
	Maintained	Without Lamp	1NO-1NC	UOLQS1B9911②
			2NO	UOLQS1B9920②
			2NO-2NC	UOLQS1B9922②
		LED	1NO-1NC	UOLQS1B③11DN②
			2NO	UOLQS1B③20DN②
			2NO-2NC	UOLQS1B③22DN②

#### Designation Code

Specify a code in place of ② or ③ in the Part No.

② Lens/LED Color Code		③ Operating Voltage Code	Input
Without Lamp	LED		
Specify a lens color code in place of ②.  NA: amber NG: green NR: red NS: blue NW: white DNY: yellow	Specify a lens/LED color code in place of ②.  A: amber G: green PW: pure white R: red S: blue W: white Y: yellow A pure white LED lamp is used for yellow illumination.	66: 6V AC/DC 11: 12V AC/DC 22: 24V AC/DC  16: 100/110V AC 126: 115/120V AC 26: 200/220V AC 246: 230/240V AC 386: 380V AC 46: 400/440V AC 486: 480V AC	Full Voltage          Transformer

- Square bezel (plastic): Black
- Marking plate size: □21.2 × 1.0 mm (2 pieces supplied)
- Illumination color W (white) and PW (pure white) marking consist of clear lens and white marking plate. See page 38.
- Other contact arrangements are also available. See page 7.

HOP LONG INDUSTRIAL AUTOMATION

### Dimensions

#### Round Extended ALS2 / AOLS2

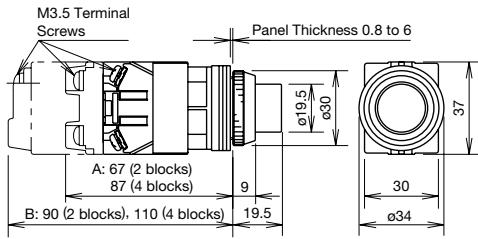

A: Full voltage  
B: Transformer

#### Round Extended with Half Shroud ALGS2 / AOLGS2

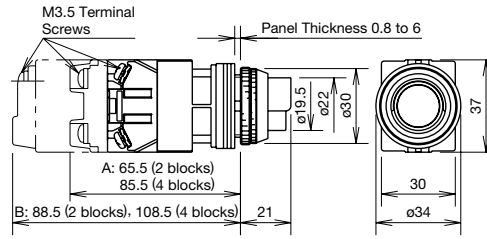

A: Full voltage  
B: Transformer

#### Round Extended with Full Shroud ALFS2 / AOLFS2

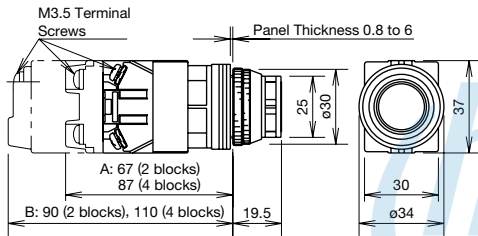

A: Full voltage  
B: Transformer

#### Mushroom Pushlock Turn Reset AVLS3

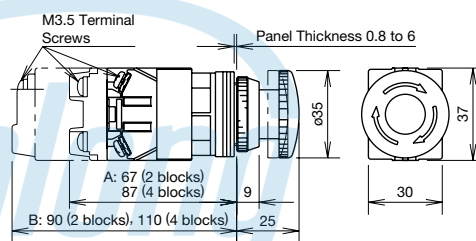

A: Full voltage  
B: Transformer

#### Square Flush ULQS1B / UOLQS1B

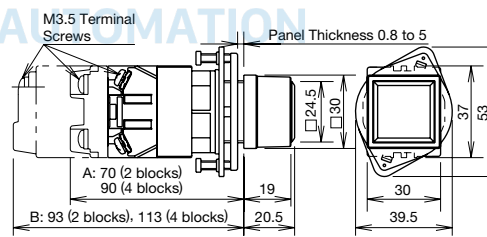

Marking Plate Size: □21.2×11 mm, 2 plates included

A: Full voltage  
B: Transformer

All dimensions in mm.

### Selector Switches (Knob Operator)

Package Quantity: 1

No. of Positions	Shape			ASS							
	Contact Arrangement Chart										
90° 2-position	Contact Code	Mounting Position	Contact	Operator Position		Maintained	Spring Return from Right	Spring Return from Left	—		
	10 (1NO)	1	NO		●					—	
		2	Dummy								
	11 (1NO-1NC)	1	NO		●		ASS210N	ASS2110N	ASS2210N *	—	
		2	NC	●							
	20 (2NO)	1	NO		●		ASS220N	ASS2120N	ASS2220N *	—	
		2	NO		●						
22 (2NO-2NC)	1	NO		●		ASS222N	ASS2122N	ASS2222N *	—		
	2	NC	●								
	3	NO		●							
2R ★ (1NO-1NC)	1	NO		■		ASS22RN-118 ★	ASS212RN-118 ★	—	—		
	2	NC		■		—	—	ASS222RN-169 ★	—		
2R ★ (1NO-1NC)	1	NC		■		—	—	ASS222RN-169 ★	—		
	2	NO		■		—	—	ASS222RN-169 ★	—		
45° 3-position	Contact Code	Mounting Position	Contact	Operator Position			Maintained	Spring Return from Right	Spring Return from Left	Spring Return Two-way	
	20 (2NO)	1	NO	●							
		2	NO		●						
	02 (2NC)	1	NC		■		ASS320N	ASS3120N	ASS3220N	ASS3320N	
		2	NC		■		ASS302N	ASS3102N	ASS3202N	ASS3302N	
	22 (2NO-2NC)	1	NO	●			ASS322N	ASS3122N	ASS3222N	ASS3322N	
		2	NO		●						
		3	NC		■						
	40 (4NO)	1	NO	●			ASS340N	ASS3140N	ASS3240N	ASS3340N	
		2	NO		●						
		3	NO		●						
	04 (4NC)	1	NC		■		ASS304N	ASS3104N	ASS3204N	ASS3304N	
2		NC		■							
3		NC		■							
3S ★	1	NO	●			ASS33SN-243 ★	—	—	—		
	2	NO		●							
3S ★	3	NC		■		—	—	—	—		
	4	Dummy				—	—	—	—		
30° 5-position / 45° 4-position	Contact Code	Mounting Position	Contact	Operator Position					Maintained	Maintained	<b>Contact Block Mounting Position and Contact Arrangement Chart</b> 
				1	2	3	4	5			
	4S ★	1	NO		■					ASS44SN-407 ★	—
		2	NC		■						
		3	NC			■					
		4	NO				■				
	4S ★	1	NO	●						ASS44SN-411 ★	—
		2	NC		●						
		3	NC			●					
		4	NO				●				
	3S ★	1	NO	●						ASS43SN-461 ★	—
		2	NC		●						
3		NC			●						
4		Dummy									
4S ★	1	NO	●						—	ASS54SN-501 ★	
	2	NC		●							
	3	NC			●						
	4	NO				●					

• On the 2-position selector switches marked with \* above, the contact operation is reversed as follows.

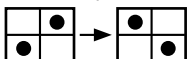

- On the contact arrangement marked with ★ in the table above, the rated current (load switching current) is reduced to a half of the rated current of the contact block. The rated insulation voltage and the rated thermal current remain unchanged.
- Selector switches with one or three contact blocks contain a dummy block.
- Knob operator: White indicator on black knob

### Selector Switches (Lever Operator)

Package Quantity: 1

No. of Positions	Shape		Contact Arrangement Chart										
	Shape	Code	UL	SP	CE	CCC							
90° 2-position	Contact Code	Mounting Position	Contact	Operator Position		Maintained	Spring Return from Right	Spring Return from Left					
	10 (1NO)	1	NO		●								
		2	Dummy										
	11 (1NO-1NC)	1	NO		●								
		2	NC	●									
	20 (2NO)	1	NO		●								
		2	NO		●								
	22 (2NO-2NC)	1	NO		●								
		2	NC	●									
		3	NO		●								
4		NC	●										
2R★ (1NO-1NC)	1	NO		■									
	2	NC	■										
2R★ (1NO-1NC)	1	NC	■										
	2	NO		■									
45° 3-position	Contact Code	Mounting Position	Contact	L	C	R	Maintained	Spring Return from Right	Spring Return from Left	Spring Return Two-way			
	20 (2NO)	1	NO	●									
		2	NO			●							
	02 (2NC)	1	NC	■									
		2	NC	■									
	22 (2NO-2NC)	1	NO	●									
		2	NO			●							
		3	NC	■									
		4	NC	■									
	40 (4NO)	1	NO	●									
		2	NO			●							
		3	NO			●							
		4	NO			●							
	04 (4NC)	1	NC	■									
2		NC	■										
3		NC	■										
4		NC	■										
3S★	1	NO	●										
	2	NO			●								
	3	NC	■										
	4	Dummy											
30° 5-position / 45° 4-position	Contact Code	Mounting Position	Contact	Operator Position					Maintained	Maintained	Contact Block Mounting Position and Contact Arrangement Chart		
	4S★	1	NC										
		2	NC	●									
		3	NC		●								
		4	NO				●						
	4S★	1	NO	●									
		2	NC		●								
		3	NC			●							
		4	NO				●						
	3S★	1	NO	●									
		2	NC		●								
		3	NC			●							
		4	Dummy				●						
	4S★	1	NO	●									
		2	NC		●								
		3	NC			●							
4		NO				●							

• On the 2-position selector switches marked with \* above, the contact operation is reversed as follows.

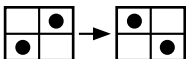

- On the contact arrangement marked with ★ in the table above, the rated current (load switching current) is reduced to a half of the rated current of the contact block. The rated insulation voltage and the rated thermal current remain unchanged.
- Selector switches with one or three contact blocks contain a dummy block.
- Lever operator: White indicator on black lever

### Key Selector Switches

Package Quantity: 1

No. of Positions	Shape			Contact Arrangement Chart										
	Contact Code			Contact Block			Operator Position			Maintained	Spring Return from Right	Spring Return from Left	—	
90° 2-position			Mounting Position	Contact	L	R				L	R			
	10 (1NO)	1	NO		●			ASS2K10N	ASS21K10N	ASS22K10N *				
		2	Dummy											
	11 (1NO-1NC)	1	NO		●			ASS2K11N	ASS21K11N	ASS22K11N *				
		2	NC	●										
	20 (2NO)	1	NO		●			ASS2K20N	ASS21K20N	ASS22K20N *				
		2	NO		●									
	22 (2NO-2NC)	1	NO		●			ASS2K22N	ASS21K22N	ASS22K22N *				
		2	NC	●										
		3	NO		●									
2R ★ (1NO-1NC)	1	NO		●			ASS2K2RN-118 ★	ASS21K2RN-118 ★	—					
	2	NC	●				—	—	ASS22K2RN-169 ★					
2R ★ (1NO-1NC)	1	NC	●				—	—	ASS22K2RN-169 ★					
	2	NO		●										
45° 3-position			Mounting Position	Contact	L	C	R				L	C	R	Spring Return Two-way
	20 (2NO)	1	NO		●			ASS3K20N	ASS31K20N	ASS32K20N	ASS33K20N			
		2	NO		●									
	02 (2NC)	1	NC	●				ASS3K02N	ASS31K02N	ASS32K02N	ASS33K02N			
		2	NC	●										
	22 (2NO-2NC)	1	NO		●			ASS3K22N	ASS31K22N	ASS32K22N	ASS33K22N			
		2	NO		●									
		3	NC	●										
	40 (4NO)	1	NO		●			ASS3K40N	ASS31K40N	ASS32K40N	ASS33K40N			
		2	NO		●									
		3	NO		●									
		4	NO		●									
	04 (4NC)	1	NC	●				ASS3K04N	ASS31K04N	ASS32K04N	ASS33K04N			
		2	NC	●										
		3	NC	●										
		4	NC	●										
3S ★	1	NO		●			ASS3K3SN-243 ★	—	—	—				
	2	NO		●										
	3	NC	●											
	4	Dummy												

- On the spring-returned, the key can be released only from the maintained position. On the maintained, the key can be released from every position. Key retained positions are also available. See page 8.
- On the 2-position selector switches marked with \* above, the contact operation is reversed as follows.

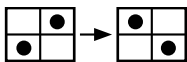

- On the contact arrangement marked with ★ in the table above, the rated current (load switching current) is reduced to a half of the rated current of the contact block. The rated insulation voltage and the rated thermal current remain unchanged.
- Key selector switches with one or three contact blocks contain a dummy block.
- Cylinder cover: Black
- Round bezel (Metal): Chrome-plated

#### Contact Block Mounting Position and Contact Arrangement Chart

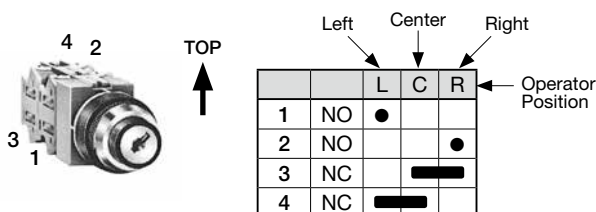



• For more contact arrangement chart, see pages 26 to 28.

### Illuminated Selector Switches

90° 2-position

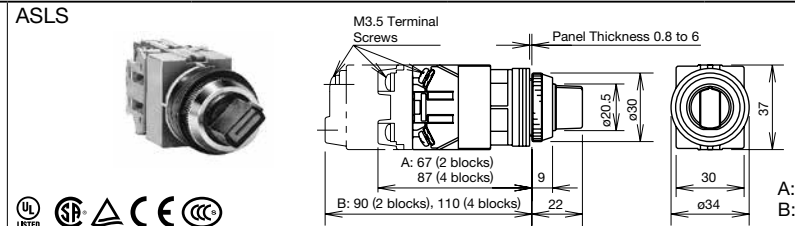
Package Quantity: 1

Shape								
Contact Arrangement Chart								
Contact Code	Contact Block		Operator Position		Lamp	Maintained	Spring Return from Right	Spring Return from Left
	Mounting Position	Contact	L	R		L     R	L     R	L     R
11 (1NO-1NC)	1	NO		●	Without Lamp	ASLS29911②	ASLS219911②	ASLS229911② *
	2	NC	●		LED	ASLS2③11DN②	ASLS21③11DN②	ASLS22③11DN② *
20 (2NO)	1	NO		●	Without Lamp	ASLS29920②	ASLS219920②	ASLS229920② *
	2	NO		●	LED	ASLS2③20DN②	ASLS21③20DN②	ASLS22③20DN② *
22 (2NO-2NC)	1	NO		●	Without Lamp	ASLS29922②	ASLS219922②	ASLS229922② *
	2	NC	●					
	3	NO		●	LED	ASLS2③22DN②	ASLS21③22DN②	ASLS22③22DN② *
	4	NC	●					

#### Designation Code

Specify a code in place of ② or ③ in the Part No.

② Lens/LED Color Code		③ Operating Voltage Code	Input		
Without Lamp	LED				
Specify a lens color code in place of ②.  NA: amber NG: green NR: red NS: blue NW: white DNY: yellow	Specify a lens/LED color code in place of ②.  A: amber G: green R: red S: blue W: white Y: yellow  A pure white LED lamp is used for yellow illumination.	66: 6V AC/DC	Full Voltage		
		11: 12V AC/DC			
		22: 24V AC/DC			
				16: 100/110V AC	Transformer
				136: 115/120V AC	
				26: 200/220V AC	
				256: 230/240V AC	
				386: 380V AC	
				46: 400/440V AC	
				486: 480V AC	

• On the selector switches marked with \* above, the contact operation is reversed as follows.

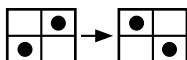

• Round bezel (Metal): Chrome-plated

#### Contact Block Mounting Position and Contact Arrangement Chart

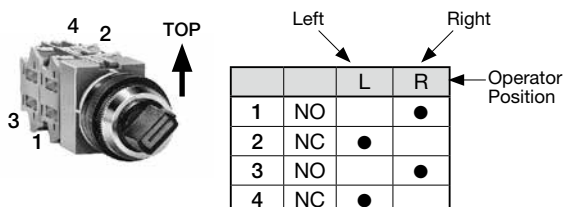

• For more contact arrangement chart, see pages 26 to 28.



### Illuminated Selector Switches

#### 45° 3-position

Contact Code	Contact Block		Operator Position			Lamp	Maintained	Spring Return from Right	Spring Return from left	Spring Return Two-way
	Mounting Position	Contact	L	C	R					
20 (2NO)	1	NO	●			Without Lamp	ASLS39920②	ASLS319920②	ASLS329920②	ASLS339920②
	2	NO			●	LED	ASLS3③20DN②	ASLS31③20DN②	ASLS32③20DN②	ASLS33③20DN②
02 (2NC)	1	NC		■		Without Lamp	ASLS39902②	ASLS319902②	ASLS329902②	ASLS339902②
	2	NC	■			LED	ASLS3③02DN②	ASLS31③02DN②	ASLS32③02DN②	ASLS33③02DN②
22 (2NO-2NC)	1	NO	●			Without Lamp	ASLS39922②	ASLS319922②	ASLS329922②	ASLS339922②
	2	NO			●					
	3	NC		■		LED	ASLS3③22DN②	ASLS31③22DN②	ASLS32③22DN②	ASLS33③22DN②
	4	NC	■							
40 (4NO)	1	NO	●			Without Lamp	ASLS39940②	ASLS319940②	ASLS329940②	ASLS339940②
	2	NO			●					
	3	NO	●			LED	ASLS3③40DN②	ASLS31③40DN②	ASLS32③40DN②	ASLS33③40DN②
	4	NO			●					
04 (4NC)	1	NC		■		Without Lamp	ASLS39904②	ASLS319904②	ASLS329904②	ASLS339904②
	2	NC	■							
	3	NC		■		LED	ASLS3③04DN②	ASLS31③04DN②	ASLS32③04DN②	ASLS33③04DN②
	4	NC	■							

#### Designation Code

Specify a code in place of ② or ③ in the Part No.

② Lens/LED Color Code		③ Operating Voltage Code	Input
Without Lamp	LED		
Specify a lens color code in place of ②.	Specify a lens/LED color code in place of ②.	66: 6V AC/DC	Full Voltage
NA: amber	A: amber	11: 12V AC/DC	
NG: green	G: green	22: 24V AC/DC	
NR: red	R: red	16: 100/110V AC	Transformer
NS: blue	S: blue	136: 115/120V AC	
NW: white	W: white	26: 200/220V AC	
DNY: yellow	Y: yellow	256: 230/240V AC	
	A pure white LED lamp is used for yellow illumination.	386: 380V AC	
		46: 400/440V AC	
		486: 480V AC	

• Round bezel (Metal): Chrome-plated

#### Contact Block Mounting Position and Contact Arrangement Chart

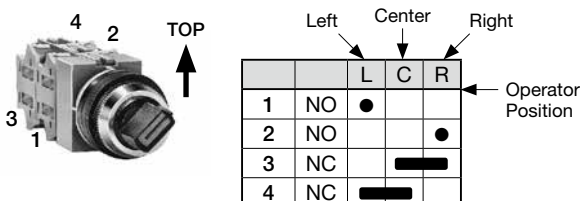

• For more contact arrangement chart, see pages 26 to 28.

### 90° 2-position (Maintained / Spring Return)

Positions				Maintained	Spring Return from Right	Spring Return from Left		
Operator				Knob, Lever, Key, Illuminated				
Contact Code	Circuit No.	Mounting Position	Contact	Operator Positions				
				L	R	L	R	
10 (1NO)	-	1	NO		●	●		
		2	Dummy					
01 (1NC)	-	1	NC	●			●	
		2	Dummy					
11 (1NO-1NC)	-	1	NO	●	●	●		
		2	NC				●	
		103	1	NC	●			●
			2	NO		●	●	
20 (2NO)	-	1	NO		●	●		
		2	NO		●	●		
02 (2NC)	-	1	NC	●			●	
		2	NC	●			●	
22 (2NO-2NC)	-	1	NO		●	●		
		2	NC	●			●	
		3	NO		●	●		
		4	NC	●			●	
	110	1	NC	●			●	
		2	NO		●	●		
		3	NC	●			●	
		4	NO		●	●		
	111	1	NO		●	●		
		2	NO		●	●		
		3	NC	●			●	
		4	NC	●			●	
117	1	NC	●			●		
	2	NO		●	●			
	3	NO		●	●			
	4	NC	●			●		
31 (3NO-1NC)	107	1	NC	●			●	
		2	NO		●	●		
		3	NO		●	●		
		4	NO		●	●		
40 (4NO)	-	1	NO		●	●		
		2	NO		●	●		
		3	NO		●	●		
		4	NO		●	●		
2R ★	118 ★	1	NO					
		2	NC					
	168 ★	1	NO					
		2	NC					
	119 ★	1	NC					
		2	NO					
169 ★	1	NC						
	2	NO						
4R ★	120 ★	1	NO					
		2	NC					
		3	NO					
		4	NC					
	170 ★	1	NO					
		2	NC					
		3	NO					
		4	NC					
	121 ★	1	NC					
		2	NO					
		3	NC					
		4	NO					
171 ★	1	NC						
	2	NO						
	3	NC						
	4	NO						

Contact Block Mounting Position and Contact Arrangement Chart

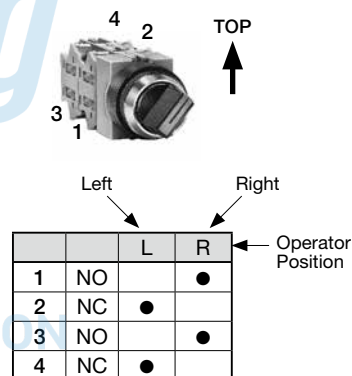

• On the contact arrangement marked with ★ in the table, the rated current (load switching current) is reduced to a half of the rated current of the contact block. The rated insulation voltage and the rated thermal current remain unchanged.

#### Part No. Development

• When circuit number is not required:

**ASS 2 11 N**  
 — Contact Code (1NO-1NC)  
 — 2-position

• When circuit number is required:

**ASS 2 11 N - 103**  
 — Circuit No.  
 — Contact Code (1NO-1NC)  
 — 2-position

# CÔNG TY CỔ PHẦN CÔNG NGHỆ HỢP LONG

## TWS series Selector Switch Contact Arrangement Charts ø25

### 45° 3-position (Maintained / Spring Return)

Positions	Maintained	Spring Return from Right	Spring Return from Left	Spring Return Two-way
Operatorc	Knob, Lever, Key, Illuminated			

Contact Code	Circuit No.	Mounting Position	Contact	Operator Positions			
				L	C	R	
11 (1NO-1NC)	202	1	NO	●			
		2	NC				
	203	1	NC				
		2	NO			●	
	302	1	NO	●			●
		2	NC				
303	1	NC		●			
	2	NO				●	
20 (2NC)	-	1	NO	●			
		2	NO			●	
301	-	1	NO			●	
		2	NO			●	
02 (2NC)	-	1	NC				
		2	NC				
		304	1	NC		●	
			2	NC			
22 (2NO-2NC)	-	1	NO	●			
		2	NO			●	
		3	NC				
		4	NC				
	210	-	1	NC			
			2	NO			●
			3	NC			
			4	NO			●
	308	-	1	NO	●		
			2	NC			
			3	NO	●		
			4	NC			
	309	-	1	NO	●		
			2	NC			
			3	NC		●	
			4	NO			●
310	-	1	NC		●		
		2	NO			●	
		3	NC		●		
		4	NO			●	
31 (3NO-1NC)	206	1	NO	●			
		2	NC				
		3	NO	●			
		4	NO			●	
207	-	1	NC				
		2	NO			●	
		3	NO	●			
		4	NO			●	
13 (1NC-3NC)	212	1	NO	●			
		2	NC				
		3	NC				
		4	NC				
	313	-	1	NC		●	
			2	NO			●
			3	NC		●	
			4	NC			

Contact Code	Circuit No.	Mounting Position	Contact	Operator Positions		
				L	C	R
40 (4NO)	-	1	NO	●		
		2	NO			●
		3	NO	●		
		4	NO			●
305	-	1	NO	●		
		2	NO			●
		3	NO	●		
		4	NO			●
04 (4NC)	314	1	NC			
		2	NC			
		3	NC			
		4	NC			
		1	NC		●	
		2	NC			
		3	NC		●	
		4	NC			

Contact Block Mounting Position and Contact Arrangement Chart

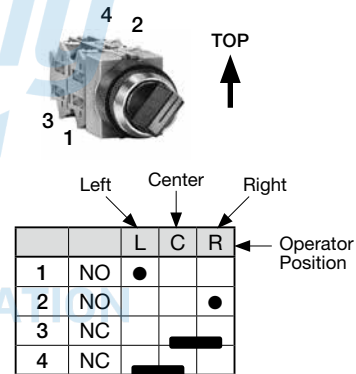

#### Part No. Development

- When circuit number is not required:

**ASS 3 22 N**





└─ Contact Code (2NO-2NC)  
└─ 3-position

- When circuit number is required:





**ASS 3 22 N - 210**

└─ Circuit No.  
└─ Contact Code (2NO-2NC)  
└─ 3-position







### 45° 3-position (Maintained)

Positions				Maintained			
							
Operator				Knob, Lever, Illuminated			
Contact Code	Circuit No.	Mounting Position	Contact	Operator Positions			
							
				L	C	R	
3S★	243★	1	NO	●			
		2	NC			●	
		3	NC		●		
		4	Dummy				
4S★	233★	1	NO	●			
		2	NC			●	
		3	NO	●		●	
		4	NO			●	
	234★	1	NO	●			
		2	NC			●	
		3	NC		●		
		4	NC			●	
	235★	1	NC			●	
			NO			●	
		2	NO			●	
			NC		●		
3		NC		●			
		NO			●		
237★		1	NO	●			
		2	NO			●	
	3	NC		●			
	4	NO			●		
240★	1	NC			●		
	2	NC			●		
	3	NC		●			
	4	NO			●		

### 45° 4-position (Maintained)

Positions				Maintained			
							
Operator				Knob, Lever			
Contact Code	Circuit No.	Mounting Position	Contact	Operator Positions			
							
				1	2	3	4
3S★	461★	1	NO	●			
		2	NC		●		
		3	NC			●	
		4	Dummy				
4S★	405★	1	NC			●	
		2	NC		●		
		3	NC			●	
		4	NC			●	
	407★	1	NC			●	
		2	NC		●		
		3	NC			●	
		4	NO				●
	409★	1	NO	●			
		2	NC		●		
		3	NC			●	
		4	NC			●	
411★	1	NO	●				
	2	NC		●			
	3	NC			●		
	4	NO				●	

### 30° 5-position (Maintained)

Positions				Maintained				
								
Operator				Knob, Lever				
Contact Code	Circuit No.	Mounting Position	Contact	Operator Positions				
								
				1	2	3	4	5
4S★	501★	1	NO	●				
		2	NC		●			
		3	NC				●	
		4	NO					●

### Contact Block Mounting Position and Contact Arrangement Chart

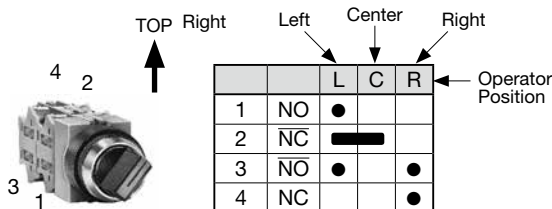

• On the contact arrangement marked with ★ in the table, the rated current (load switching current) is reduced to a half of the rated current of the contact block. The rated insulation voltage and the rated thermal current remain unchanged.

### Part No. Development











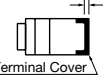

- When circuit number is not required:

ASS 3 4S N  
 └── Contact Code  
 └── 3-position

- When circuit number is required:

ASS 3 4S N - 233  
 └── Circuit No.  
 └── Contact Code (2NO-2NC)  
 └── 3-position

### Terminal Covers

Terminal Cover	HW-VL2	HW-VL3	HW-VL5	APS-PVL	Use of terminal covers increases the depth by the dimensions below.
 39.8H x 14.1W	 37.8H x 26W	 39.1H x 15.5W	 36H x 29.4W	 Terminal Cover	
Switch/Pilot Light					
<ul style="list-style-type: none"> <li>• Pilot light</li> <li>APS</li> <li>UPQS</li> <li>UPQMS</li> </ul>	Full Voltage			X	+6 mm
	Transformer DC-DC Converter	X			+3 mm
<ul style="list-style-type: none"> <li>• Pushbutton</li> <li>ABS</li> <li>AOS</li> <li>ABGS</li> <li>AOGS</li> <li>ABFS</li> <li>AOFS</li> <li>AKS</li> <li>AVS</li> <li>AJS</li> <li>AZS</li> <li>ATS</li> <li>UTS</li> <li>AYS</li> </ul>	1 contact block 	X			+3.5 mm
	2 contact blocks 	X 2 pieces			
	3 contact blocks 	X 2 pieces			
	4 contact blocks 	X 2 pieces			
<ul style="list-style-type: none"> <li>• Selector switch</li> <li>ASS</li> </ul>	4 contact blocks 	X 2 pieces			
<ul style="list-style-type: none"> <li>• Illuminated pushbutton</li> <li>ALS    AOLFS</li> <li>AOLS    ULOS</li> <li>ALGS    UOLQS</li> <li>AOLGS    AVLS</li> <li>ALFS    ATLS</li> </ul>	Full Voltage 	X 2 pieces			+3.5 mm
<ul style="list-style-type: none"> <li>• Illuminated selector switch</li> <li>ASLS</li> </ul>	Full Voltage 			X	+3 mm
<ul style="list-style-type: none"> <li>• Push-to-check pilot light</li> <li>APS</li> </ul>	Transformer DC-DC Converter 		X		+3 mm

#### Ordering Terminal Covers

Terminal covers are ordered separately.

When ordering terminal covers, specify the Part No. and required quantity.

### Nameplates

Dimensions (mm)	Legend	Material	Part No.	Ordering No.	Package Quantity	Description
	Blank	Aluminium 1.2 mm thick	NSA-0	NSA-0	1	• Black
				NSA-0PN10	10	
	With Legend		NSA-*	NSA-*	1	• White letters on black background
				NSA-*PN10	10	
	Blank	Aluminium 1.2 mm thick	NSALO	NSALO	1	• Black
				NSALOPN10	10	
	Blank	Stainless steel 0.8 mm thick	NFSO	NFSO	1	• Stainless steel ground color
				NFSOPN10	10	

• Specify a legend code in place of \* in the Ordering No.











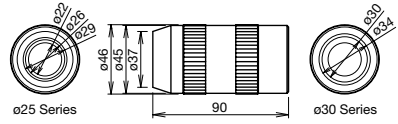

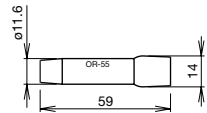

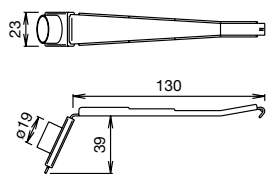
#### Legends

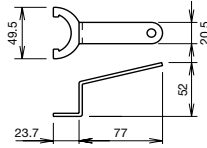

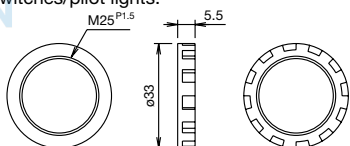

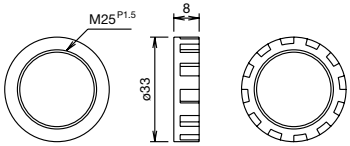

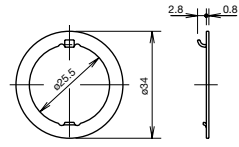

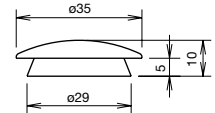

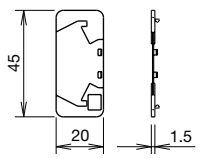
Code	Legend
0	(blank)
1	ON
2	OFF
3	START
4	STOP
31	OFF-ON
35	HAND-AUTO
53	HAND-OFF-AUTO

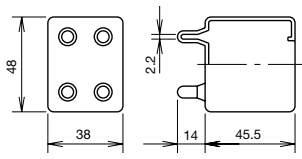
#### Example of Shape and Engraving Area

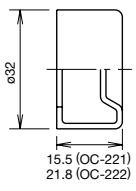
Shape	Engraving Area		Max. No. of Lines	No. of Letters on 1 Line
	Height	Width		
Standard (NSA/NFSO) 	4	31	1	17
Mushroom (NSALO) 	8	31	2	17

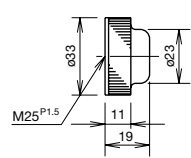
- The above example is when the letter is 3 mm tall.
- Engraving must be made within 1.5 mm from the sides.

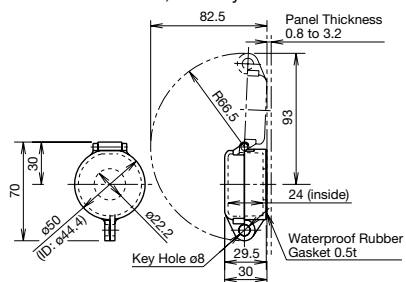

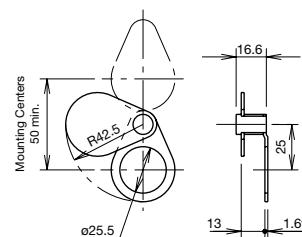

<b>Accessories</b>					
Shape	Material	Part No.	Ordering No.	Package Quantity	Dimensions (mm)
	Rubber (nitril)	OR-12	OR-12	1	<ul style="list-style-type: none"> <li>Used to tighten the round bezel when installing the TWS switch/pilot light onto a panel.</li> </ul> 
	Rubber (nitril)	OR-55	OR-55	1	<ul style="list-style-type: none"> <li>Used to install and remove LED lamps.</li> </ul> 
	Metal (steel: zinc-plated) / Rubber (nitril)	TW-KC1	TW-KC1	1	<ul style="list-style-type: none"> <li>Used to remove contact blocks, transformers, lenses and adapters.</li> </ul> 
	Metal (steel: zinc-plated)	TWST-T1	TWST-T1	1	<ul style="list-style-type: none"> <li>Used to tighten the locking ring on the square switches/pilot lights.</li> </ul> 
Locking Ring (For Square Units)  	Polyamide	OG-RT1	OG-RT1PN02	2	<ul style="list-style-type: none"> <li>Used to attach square pushbuttons and illuminated pushbuttons on to the panel.</li> <li>Mounting centers are the same as round switches/pilot lights.</li> </ul> 
	Polyamide	OG-RT2	OG-RT2PN02	2	<ul style="list-style-type: none"> <li>Used to attach pilot lights on to the panel.</li> <li>Mounting centers are the same as round switches/pilot lights.</li> </ul> 
	Metal (steel: zinc-plated)	OGL-21	OGL-21PN10	10	<ul style="list-style-type: none"> <li>Used to prevent the operator from rotating. Generally used when using no nameplates on selector switches.</li> </ul> 
	Rubber (nitril /black)	OBS-13B	OBS-13BPN05	5	<ul style="list-style-type: none"> <li>Used to plug unused ø25.5mm mounting holes. Gray also available (ordering no. OBS-13PN05)</li> </ul> 

Accessories					
Shape	Material	Part No.	Ordering No.	Package Quantity	Dimensions (mm)
	Polyamide	HW-VL1	HW-VL1PN10	10	<ul style="list-style-type: none"> <li>Used to prevent contact between adjacent lead wires when units are mounted closely. Barriers should be always used in close mounting.</li> </ul> 
	Rubber (nitril) Black	OCS-99	OCS-99	1	<ul style="list-style-type: none"> <li>Dust cover boot used for pushbuttons and selector switches.</li> <li>Temperature range: -5 to +60°C</li> <li>Black</li> </ul> 
	For flush pushbuttons	OC-221	OC-221	1	<ul style="list-style-type: none"> <li>Used to cover and protect pushbuttons where units are subject to water splash. Not suitable for outdoor use or where the units are subject to oil splash.</li> </ul> 
	For extended pushbuttons	OC-222	OC-222	1	
	Rubber (nitril)	OCS-11①	OCS-11①	1	<ul style="list-style-type: none"> <li>B (black), G (green), R (red), Y (yellow)</li> <li>Metallic bezels covered with rubber boot to enhance waterproof and oiltight characteristics.</li> <li>Button is installed in the cover. Remove the button from the pushbutton before using the button cover.</li> <li>Temperature range: -5 to +60°C</li> </ul> 
	Polyarylate (gasket: nitril rubber)	OLS-KL1	OLS-KL1	1	<ul style="list-style-type: none"> <li>Used to protect momentary and maintained pushbuttons, illuminated pushbuttons, knob selector switches, and key selector switches.</li> </ul> 
	Metal (steel: zinc-plated)	OLS-C	OLS-C	1	<ul style="list-style-type: none"> <li>Used to protect flush buttons from inadvertent operation.</li> <li>Can be easily attached under the round bezel.</li> </ul> 

Note: Specify a button cover color code in place of ① in the Ordering No.















### Maintenance Parts

Shape	Material	Part No.	Ordering No.	Package Quantity	Color Code		
<b>Bezel</b> 	<b>1</b> Pushbutton/Pilot Light/Key Selector/Illuminated Selector ø30 (ø21) H9	<b>1</b> Metal (chrome-plated) ZDC <b>2</b> Polycarbonate	OG-22 OGP-22①	OGP-22PN02 OGP-22①PN02	2	B (black), G (green), R (red), Y (yellow), W (white) • Cannot be used for switches/pilot lights with half shroud or full shroud.	
	<b>3</b> Selector Switch (except key selector) ø30 (ø23) H9	<b>3</b> Metal (chrome-plated) ZDC <b>4</b> Polycarbonate	OGP-33 OGP-33①	OGP-33PN02 OGP-33①PN02			
	<b>5</b> Pushbutton with Full Shroud ø23.5 H17	<b>5</b> Metal (chrome-plated) ZDC	ABS2FN	ABS2FN			
	<b>6</b> Mushroom with Full Shroud ø42 H18		ABS3GN	ABS3GN			
	<b>7</b> Pushbutton, Illuminated Pushbutton with Half Shroud ø31 H20.2	<b>7</b> Half shroud: brass Others: chrome-plated ZDC	ALS1G	ALS1G	1	With locking ring (chrome-plated brass)	
	<b>8</b> Illuminated Pushbutton with Full Shroud ø30 H19	<b>8</b> Illumination shroud: chrome-plated ZDC	ALS1F	ALS1F			
	<b>Button</b> 	<b>1</b> Flush ø19.4 H3.3 <b>2</b> Extended ø19.4 H9.3	Polyacetal	ABS1BN-①	ABS1BN-①PN05	5	B (black), G (green), R (red), S (blue), Y (yellow), W (white) • Light color
		<b>3</b> ø35mm Mushroom ø35 H16.7		ABS2BN-①	ABS2BN-①PN05		
<b>4</b> Square Flush □25 H12		ABS3BN-①		ABS3BN-①PN02	2		
<b>5</b> Square Extended □25 H18		UBQS1BN-①		UBQS1BN-①PN02	2	B (black), G (green), R (red), S (blue), Y (yellow) • Light color	
<b>6</b> Pushlock Turn Reset ø35 H16		UBQS2BN-①		UBQS2BN-①PN02			
<b>7</b> Push-Pull ø35 H22.3		AVS3BN-①		AVS3BN-①PN02			
		AYS3BN-①		AYS3BN-①PN02			
<b>Lens (for illuminated pushbuttons)</b> 	<b>1</b> Dome ø19.6 H25 <b>2</b> For Square Metal Bezel Unit □24 H8.5	AS resin	APS106L-②	APS106L-②PN05	5	C (clear), G (green), R (red), S (blue) A (amber), W (white), Y (yellow) C (clear), G (green), R (red), S (blue) (Use clear lens for white illumination) A (amber), Y (yellow)	
			APS106LD-②	APS106LD-②PN05			
			UPQS306L-②	UPQS306L-②PN05			
			UPQS306LD-②	UPQS306LD-②PN05			
<b>Lens (for pilot lights and illuminated pushbuttons)</b> 	For Square with Plastic Bezel □24.4 H7.6	AS resin	UPQS106L-②	UPQS106L-②PN05	5	C (clear), G (green), R (red), S (blue)	
			UPQS106LD-②	UPQS106LD-②PN05	5	A (amber), Y (yellow)	
<b>Lens</b> 	<b>1</b> Extended ø19.6 H20 M16 <b>2</b> Pushlock Turn Reset ø35 H25.5	AS resin	ALS06L-②	ALS06L-②PN05	5	C (clear), G (green), R (red), S (blue)	
			ALS06LD-②	ALS06LD-②PN05		A (amber), Y (yellow), W (white)	
				AVLS3L-R	AVLS3L-RPN02		

Note: Specify a button color code or lens color code in place of ① or ② in the Ordering No.  
 Use a clear lens for white or pure white illumination.

### Maintenance Parts

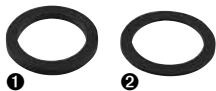
Shape	Material	Part No.	Ordering No.	Package Quantity	Remarks		
<b>Selector Operator</b> 	Plastic	ASSHHY-①	ASSHHY-①PN02	2	B (black), G (green), R (red)		
		ASSHHL-①	ASSHHL-①PN02				
	Plastic	TWS-HC1①	TWS-HC1①PN05	5	B (black), G (green), R (red), S (blue), Y (yellow), W (white)		
		ASLSLDY-②	ASLSLDY-②	1	G (green), R (red), S (blue)		
	ASLSDDY-②	ASLSDDY-②			A (amber), W (white), Y (yellow),		
<b>Cap for Key Selector</b> 	Plastic	AKS2B-①	AKS2B-①PN05	5	B (black), R (red)		
<b>Clear Button Cover</b> 	Plastic	ABS1B-C	ASB1B-CPN05	5	B (black), G (green), R (red), W (white) Y (yellow) • Used on flush pushbuttons to indicate a mark or a symbol engraved on the marking plate. The clear button cover holds the marking plate.		
<b>Marking Plate for Clear Button Cover</b> 		TWS-0①	TWS-0①PN10			10	
<b>Marking Plate</b> 	Plastic	UPQS106P-W	UPQS106P-WPN02	2	• Engraving area: □19.2 0.5mm thick max.		
		UPQS106P-C	UPQS106P-CPN02				
		UPQS306N-W	UPQS306N-WPN02			• Engraving area: □19 0.5mm thick max.	
<b>Contact Block</b> 		1NO	 HW-C10	HW-C10	1	Housing: Blue Push rod: Green	
		1NC	 HW-C01	HW-C01		Housing: Purple red Push rod: Red	
		Early Make	 HW-C10R	HW-C10R		Housing: Blue Push rod: Black	
		Late Break	 HW-C01R	HW-C01R		Housing: Purple red Push rod: White	
<b>Dummy Block</b> 			TW-DB	TW-DBPN10	10	• Used for non-illuminated units with 1NO or 1NC contact blocks.	
<b>Full Voltage Adapter</b> 			TW-DA1B	TW-DA1BPN02	2	• Adapter with M3.5 screws used for illuminated pushbutton or illuminated selector switch. Snaps on to the back of the contact block.	
<b>Spare Key</b> 		For Key Selector Switch	Metal	TW-SK-0	TW-SK-0PN02	2	• W19.7 L39 t1.8
<b>Rubber Washer</b> 	Rubber	①3.0-mm thick	OW-22	OW-22PN10	10	• Outside diameter: ø33.8 • Inside diameter: ø25.5	
		②1.5-mm thick	OW-21	OW-21PN10			

Note: Specify a color code in place of ① or ② in the Ordering No.

### Maintenance Parts

#### LED Lamps (LSTD)

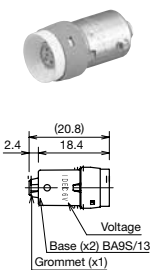
Dimensions	Operating Voltage	Current Draw		Part No.	Ordering No.	Illumination Color Code	Package Quantity	Base	
		AC	DC						
 <p>Dimensions: (20.8) total length, 18.4 length to base, 2.4 diameter. Base (x2) BA9S/13 Grommet (x1).</p>	6V AC/DC ±5%	8 mA	7 mA (A, R, W) 5.5 mA (G, PW, S)	LSTD-6②	LSTD-6② LSTD-6②PN10	Specify a color code in place of ② in the Ordering No.  A: amber G: green PW: pure white R: red S: blue W: white	1	BA9S/13	
	12V AC/DC ±10%	11 mA	10 mA	LSTD-1②	LSTD-1② LSTD-1②PN10		1		
	24V AC/DC ±10%	11 mA	10 mA	LSTD-2②	LSTD-2②		Use a pure white (PW) LED lamp with yellow (Y) lens.		1
					LSTD-2②PN10				10
		11 mA	10 mA	LSTD-2②	LSTD-2②				1
					LSTD-2②PN10				10

#### Replacement LED Lamps for Incandescent Lamps

Incandescent Lamp					Replacement LED Lamp			
Dimensions	Part No.	Rated Voltage	Lamp Ratings	Base	Part No.	Color Code	Rated Voltage	Base
 <p>Glass bulb: ø11 Length: 23</p>	LS-6	6V AC/DC	1W (6V)	BA9S/13	LSTD-6②	A: amber G: green PW: pure white R: red S: blue W: white Use a pure white (PW) lamp for yellow (Y) illumination.	6V AC/DC	BA9S/13
	LS-8	12V AC/DC	1W (18V)		LSTD-1②		12V AC/DC	
	LS-2	18V AC/DC	1W (24V)		LSTD-2②		24V AC/DC	
	LS-3	24V AC/DC	1W (30V)		LSTD-2②		24V AC/DC	

- When using commercially available incandescent lamps, choose lamps with same dimensions, rated voltage, lamp ratings, and base

INDUSTRIAL AUTOMATION

### Transformer

Shape	Primary Voltage	Secondary Voltage	Part No.	Applicable Load
	100/110V AC	5.5V AC, 1W	TWR516	LSTD-6 LED lamp (6V AC/DC)
	115/120V AC		TWR5126	
	200/220V AC		TWR526	
	230/240V AC		TWR5246	
	380V AC		TWR5386	
	400/440V AC		TWR546	
	480V AC		TWR5486	

### Specifications

Operating Voltage	100/110V AC, 115/120V AC, 200/220V AC, 230/240V AC, 380V AC, 400/440V AC, 480V AC (50/60Hz)
Current Draw	2.4 VA
Rated Insulation Voltage	600V
Insulation Resistance	100 MΩ minimum (500V DC megger)
Operating Temperature	-30 to +60°C (no freezing)
Storage Temperature	-40 to +80°C (no freezing)
Operating Humidity	35 to 85% RH (no condensation)
Vibration Resistance	Damage Limits: 30 Hz, amplitude 1.5 mm Operating extremes: 5 to 55 Hz, amplitude 0.5 mm
Shock Resistance	Damage limits : 1,000 m/s <sup>2</sup>
Dielectric Strength	2,500V AC, 1 minute
Terminal Screw	M3.5
Applicable Wire	2 mm <sup>2</sup> maximum, 2 wires maximum
Weight (approx.)	87g

### Dimensions

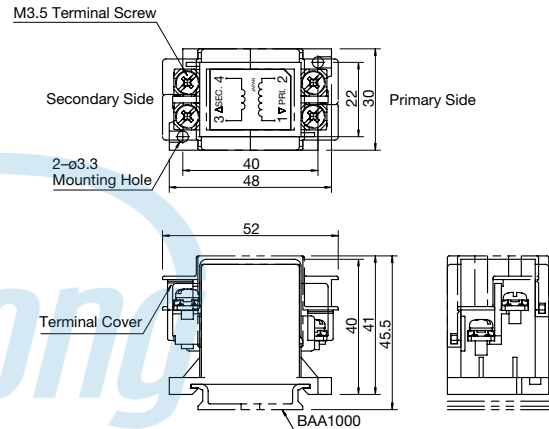

### Accessories

#### DIN Rail

Part No.	Ordering No.	Length	Weight (approx.)	Material	Package Quantity
BAA1000	BAA1000PN10	1000 mm	200g	Aluminum	10
BAP1000	BAP1000PN10	1000 mm	320g	Steel	10

#### End Clip

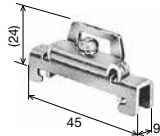
Part No.	Ordering No.	Applicable DIN Rail	Weight (approx.)	Material	Package Quantity	Dimensions
BNL6	BNL6PN10	BAA1000 BAP1000	15g	Steel (Zinc-plated)	10	

### Safety Precautions

- Turn off the power to the TWS series before starting installation, removal, wiring, maintenance, and inspection of the products. Failure to turn power off may cause electrical shocks or fire hazard.
- To avoid a burn on your hand, use the lamp holder tool when replacing lamps.
- For wiring, use wires of a proper size to meet the voltage and current requirements. Tighten the M3.5 terminal screws to a tightening torque of 1.0 to 1.3 N·m. Failure to tighten terminal screws may cause overheat and fire.
- Use HW-C contact blocks for the TWS series. Do not replace with or add conventional TW series contact blocks. Using a different type of contact block may lead to malfunction.

### Instructions

#### Installation of Selector Operators

1. The shaft of each selector or illuminated selector switch has a recess to identify in which direction to install the operator. Align the operator with the recess and press in the operator.
2. Press color insert (non-illuminated) into the operator. The color insert retains the operator.

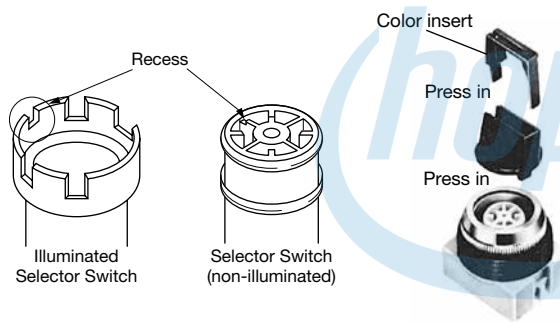

#### Standard Position

2-Position, 90°	3-Position, 45°	4-Position, 45°	5-Position, 30°

[Example]

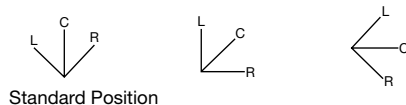

Standard Position

The non-illuminated operators can be installed in positions other than the standard position as shown above.

#### Removing the Operator

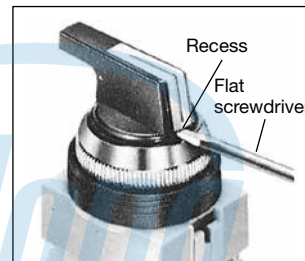

##### 1. Removing the Color Insert

Insert a flat screwdriver (4.5mm wide at maximum) into the recess of the color insert. Turn the screwdriver to push out the insert from the operator.

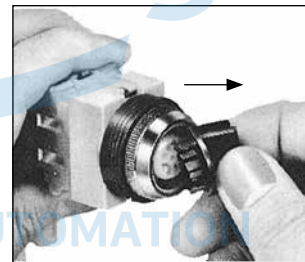

##### 2. Removing the Operator (Non-illuminated)

Push the operator sideways as shown in the left photo to remove the operator.

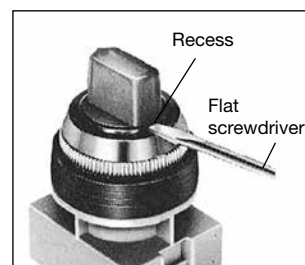

##### 3. Removing the Operator (Illuminated)

Insert a flat screwdriver into the recess of the operator and turn the screwdriver to remove the operator.

#### Removing Contact Blocks, Transformers, and Full Voltage Adapters

Insert the end of the contact block removal tool into the snap-fit latch of the contact block (or transformer, full voltage adapter) and pull the tool as shown on the right.

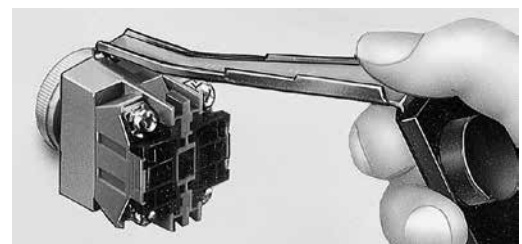

### Instructions

#### Installing Lenses

##### Lens Structure and Marking Plate

All square lens units are marking types. To engrave on the marking plate, remove the marking plate from the lens.

##### Square Pilot Lens

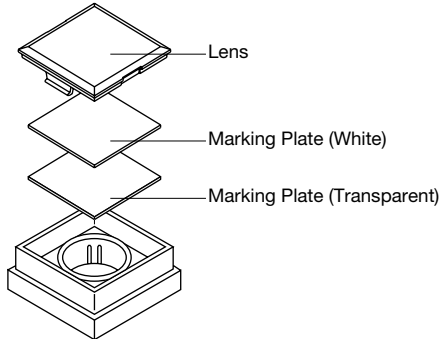

##### Square Illuminated Pushbutton

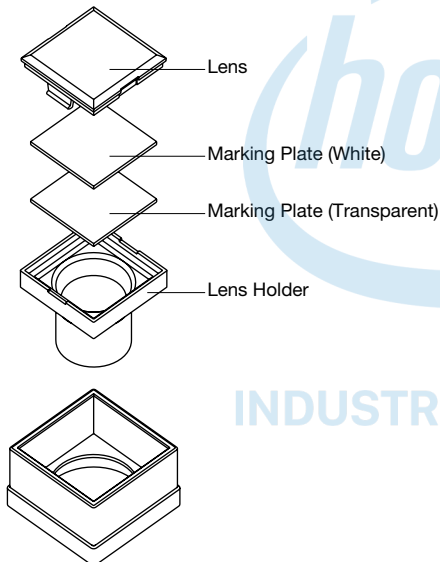

#### Replacement of LED Lamps

LED lamps can be replaced by using the lamp holder tool (OR-55) from the front of the panel, or by removing the contact block from the operator unit.

##### Removing the Lamps from the Front of the Panel

###### [How to Remove]

1. To remove, slip the LED lamp holder tool onto the LED lamp head lightly. Then push slightly, and turn the lamp holder tool counterclockwise.

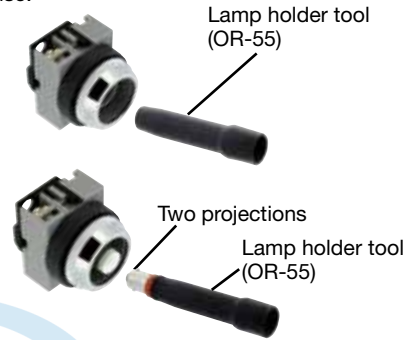

###### [How to Install]

1. To install, insert the LED lamp head into the lamp holder tool (OR-55), and hold the lamp as shown in the figure below.



#### Collective Mounting

When mounting the units closely in a horizontal row on 34mm centers, use optional barriers to prevent interconnection between adjoining terminals. The barriers can be attached simply by pressing them onto the sides of contact blocks.

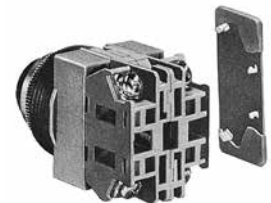
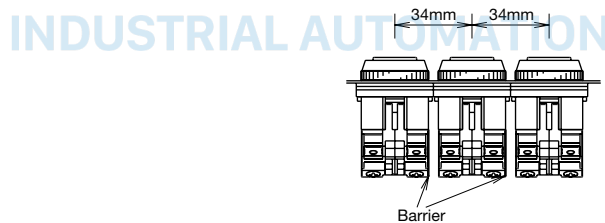

#### Tightening Torque

Tighten the M3.5 terminal screws to a torque of 1.0 to 1.3 N·m.

### Instructions

#### Panel Thickness and Rubber Washer

Adjust the thickness of the rubber washers according to the panel thickness. Also, make sure to include the nameplate thickness when using a nameplate.

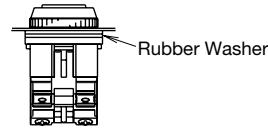

#### Applicable Models

- Momentary Pushbutton (Excluding Extended with Half Shroud, Extended with Full Shroud, and Square)
- Round Pilot Light (APS1)

Panel Thickness (mm)	Rubber Washer	
	1.5 mm	3.0 mm
Supplied	2 pieces	1 piece
0.8 to 2.5	2 pieces	1 piece
2.5 to 4.0	1 piece	1 piece
4.0 to 5.5	—	1 piece
5.5 to 6.0	1 piece	—

#### Applicable Models

- Momentary Pushbutton with Half Shroud (ABGS2)

Panel Thickness (mm)	Rubber Washer	
	1.5 mm	3.0 mm
Supplied	1 piece	1 piece
0.8	1 piece	1 piece
0.8 to 2.3	—	1 piece
2.3 to 3.8	1 piece	—

#### Applicable Models

- Maintained Extended Pushbutton with Half Shroud (AOGS2)
- Momentary Illuminated Pushbutton with Half Shroud (ALGS2)
- Maintained Illuminated Pushbutton with Half Shroud (AOLGS2)

Panel Thickness (mm)	Rubber Washer	
	1.5 mm	3.0 mm
Supplied	2 pieces	1 piece
0.8	2 pieces	1 piece
0.8 to 2.3	1 piece	1 piece
2.3 to 3.8	—	1 piece
3.8 to 5.3	1 piece	—

#### Applicable Models

- Momentary Extended Pushbutton with Full Shroud (ABFS2)

Panel Thickness (mm)	Rubber Washer	
	1.5 mm	3.0 mm
Supplied	3 pieces	1 piece
0.8 to 1.5	3 pieces	1 piece
1.5 to 3	2 pieces	1 piece
3.0 to 4.5	1 piece	1 piece
4.5 to 6	—	1 piece

#### Applicable Models

- Maintained Extended Pushbutton with Full Shroud (AOFSS2)

Panel Thickness (mm)	Rubber Washer	
	1.5 mm	3.0 mm
Supplied	4 pieces	1 piece
0.8 to 1.5	4 pieces	1 piece
1.5 to 3.0	3 pieces	1 piece
3.0 to 4.5	2 pieces	1 piece
4.5 to 6.0	1 piece	1 piece

#### Applicable Models

- Other Models (Excluding Square)

Panel Thickness (mm)	Rubber Washer	
	1.5 mm	3.0 mm
Supplied	3 pieces	1 piece
0.8 to 2.5	3 pieces	1 piece
2.5 to 4.0	2 pieces	1 piece
4.0 to 5.5	1 piece	1 piece
5.5 to 6.0	—	1 piece

### Installation of LED Illuminated Units

1. Note the polarity for wiring when connecting to DC-DC converter unit.

Terminal No.	Polarity
X1	Positive
X2	Negative

2. Transformer units are recommended for use in areas subjected to noise.

### Notes on LED Illuminated Units

LED lamps consist of semiconductors. If the applied voltage exceeds the rated voltage, LED elements may deteriorate due to overheat, resulting in significant decrease in luminance, hue change, or failure of lighting. Also, if an extraneous noise, transient voltage, or transient current is applied to the circuit, similar effects may occur. When using LED lamps, observe the following instructions.

#### Rated Voltage

The LED lamps are rated at 6V, 12V, or 24V AC/DC, and can be used within  $\pm 10\%$  the rated voltage of either AC or DC.

#### DC Power

1. Switching power supply

Regulated voltage from switching power supply is best suited. Make sure to use within the rated voltage of the LED lamp.

2. Rechargeable battery

Note that the battery voltage may exceed the rated voltage of the LED lamp while the battery is being charged and immediately after the charging is complete. Be sure to use the LED lamp on a voltage of  $\pm 10\%$  the rated voltage.

3. Full-wave rectification

Since the LED lamp is AC/DC compatible, a diode bridge for rectification is not necessary. If the LED lamp is used on a full-wave rectification current through a diode bridge, the rectifier diodes will reduce the voltage, resulting in lower luminance.

4. Single-phase half-wave rectification

This is not suitable for the power source of LED lamps. Use constant-voltage DC power.

#### Noise

LED elements deteriorate due to extraneous noise, resulting in significant decrease in luminance, hue change, or failure of lighting. When such effects are anticipated, take a protection measure shown below, such as RC elements or a surge absorber.

3. Notes for Pure White LED Lamps

- Do not use the pure white LED outdoors, otherwise it will lead to the degradation of brightness and color. Do not remove or apply shock to the cap on the pure white LED lamp, otherwise it may break or damage the cap.
- For the pure white LED, use a white lens. The illumination color will be dull if a different color is used.

#### [Protection Example 1] For AC circuit

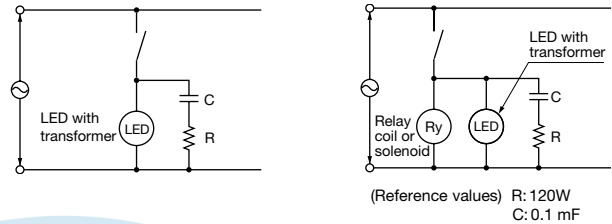

#### [Protection Example 2] For DC circuit

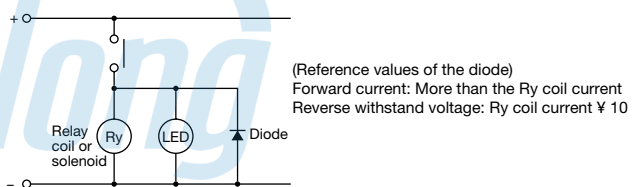

#### Countermeasures against Dim Lighting

- Leakage currents through the transistors or a contact protection circuit may cause the LED lamp to illuminate dimly even when the output is off.
- When the LED lamp is illuminated by a transistor output, take the following measure.

#### [Circuit Example]

Connect shunt resistor R in parallel with the LED lamp.

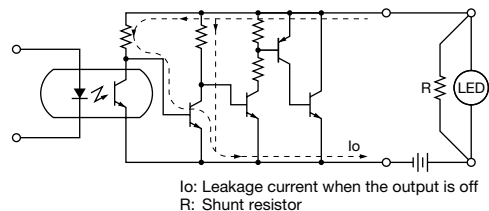

I<sub>0</sub>: Leakage current when the output is off  
R: Shunt resistor

## IDEC CORPORATION

#### Head Office

6-64, Nishi-Miyahara-2-Chome, Yodogawa-ku, Osaka 532-0004, Japan

<b>Japan</b>	IDEC Corporation	Tel: +81-6-6398-2527	marketing@idec.co.jp
<b>USA</b>	IDEC Corporation	Tel: +1-408-747-0550	opencontact@idec.com
<b>Australia</b>	IDEC Australia Pty. Ltd.	Tel: +61-3-8523-5900	sales@au.idec.com
<b>Germany</b>	IDEC Elektrotechnik GmbH	Tel: +49-40-25 30 54 - 0	service@eu.idec.com
<b>China/Shanghai</b>	IDEC (Shanghai) Corporation	Tel: +86-21-6135-1515	idec@cn.idec.com
<b>China/Beijing</b>	IDEC (Beijing) Corporation	Tel: +86-10-6581-6131	idec@cn.idec.com

<b>China/Shenzen</b>	IDEC (Shenzen) Corporation	Tel: +86-755-8356-2977	idec@cn.idec.com
<b>Hong Kong</b>	IDEC Izumi (H.K.) Co., Ltd.	Tel: +852-2803-8989	info@hk.idec.com
<b>Taiwan</b>	IDEC Taiwan Corporation	Tel: +886-2-2698-3929	service@tw.idec.com
<b>Singapore</b>	IDEC Izumi Asia Pte. Ltd.	Tel: +65-6746-1155	info@sg.idec.com
<b>Thailand</b>	IDEC Asia (Thailand) Co., Ltd	Tel: +66-2-392-9765	sales@th.idec.com

 [www.idec.com](http://www.idec.com)

Specifications and other descriptions in this brochure are subject to change without notice.  
2016 IDEC Corporation, All Rights Reserved.

EP1523-4 FEBRUARY 2017

Hotline: 1900.6536 - Website: [HOPLONGTECH.COM](http://HOPLONGTECH.COM)

