















Think Automation and beyond...

A series Switches & Pilot Lights















IDEC CORPORATION

ø16 ø12 ø10 ø8 A Series Selection Guide

Series		A6 Series Switches and Pilot Lights			
Mounting Hole Size		ø16			
Model		AL6	AB6	AS6	AS6 (key)
Shape					Disc tumbler key  Wave key 
Unit		Illuminated Pushbuttons (Momentary, Maintained) Pilot Light	Pushbuttons (Momentary, Maintained)	Selector Switch (90° 2-position maintained, 90° 2-position spring return, 45° 3-position maintained, 45° 3-position spring return)	Key Selector Switch (90° 2-position maintained, 90° 2-position spring return, 45° 3-position maintained, 45° 3-position spring return)
Bezel Size (mm)		  			  
Bezel Color		Black			
Light Source		LED Lamp (IDEC's LATD)	—	—	—
Button/Illumination Color		Illumination: amber, blue, green, pure white, red, white, yellow	Button: black, blue, green, red, white, yellow Lens: amber, blue, green, red, yellow, white	Knob: black	Key cylinder: chrome plating (metal)
Contact	Contact Configuration	SPDT, DPDT (Gold-clad silver contact)			
	Contact Rating (resistive load)	110V AC/1A, 24V DC/1A			
Durability	Electrical	Momentary: 100,000 operations minimum Maintained: 50,000 operations minimum		100,000 operations minimum	
	Mechanical	Momentary: 1,000,000 operations minimum Maintained: 100,000 operations minimum		250,000 operations minimum	
Degree of Protection		IP65, IP40 (IEC 60529)			
Terminal Style		Solder terminal			
Accessories	Switch Guard	Yes	Yes	—	—
	Socket	Yes	Yes	Yes	Yes
	Terminal Cover	Yes	Yes	Yes	Yes
	Dust Cover	Yes	Yes	—	—
	Mounting Hole Plug	Yes	Yes	Yes	Yes
Remarks		<ul style="list-style-type: none"> LED lamps contain a current-limiting resistor and a protection diode. Available with three-sided barrier. 	<ul style="list-style-type: none"> Available with three-sided barrier. 	<ul style="list-style-type: none"> Operator position can be changed by IDEC's original bezel rotating and locking system. 	
Approvals					
Page		5	8	10	11

A Series Selection Guide ø16 ø12 ø10 ø8





Series	A Series Switches and Pilot Lights					
Mounting Hole Size	ø12		ø10		ø8	
Model	AL2	AB2	AL1	AB1	AL8	AB8
Shape						
Unit	<ul style="list-style-type: none"> • Illuminated Pushbuttons (Momentary, Maintained) • Pilot Light 		<ul style="list-style-type: none"> • Illuminated Pushbuttons (Momentary, Maintained) • Pilot Light 		<ul style="list-style-type: none"> • Illuminated Pushbuttons (Momentary, Maintained) • Pilot Light 	
Bezel Size (mm)						
Bezel Color	Black		Black		Black	
Light Source	LED lamp (IDEC's LAD-S)	—	LED lamp (IDEC's LAD-S)	—	LED lamp (IDEC's LAD-S)	—
Button/Illumination Color	Illumination: amber, green, red, white, yellow Lens: amber, blue, green, red, yellow, white	Button: black, blue, green, red, white, yellow Lens: amber, blue, green, red, yellow, white	Illumination: amber, green, red, white, yellow Lens: amber, blue, green, red, yellow, white	Button: black, blue, green, red, white, yellow Lens: amber, blue, green, red, yellow, white	Illumination: amber, green, red, white, yellow Lens: amber, blue, green, red, yellow, white	Button: black, blue, green, red, white, yellow Lens: amber, blue, green, red, yellow, white
Contact	Contact Configuration	SPDT, DPDT (silver contact)		SPDT (silver contact)		SPDT (silver contact)
	Contact Rating (resistor load)	110V AC/1A, 24V DC/1A		110V AC/1A, 24V DC/1A		110V AC/1A, 24V DC/1A
Durability	Electrical	Momentary: 100,000 operations minimum Maintained: 50,000 operations minimum		Momentary: 100,000 operations minimum Maintained: 50,000 operations minimum		Momentary: 100,000 operations minimum Maintained: 50,000 operations minimum
	Mechanical	Momentary: 200,000 operations minimum Maintained: 100,000 operations minimum		Momentary: 200,000 operations minimum Maintained: 100,000 operations minimum		Momentary: 200,000 operations minimum Maintained: 100,000 operations minimum
Degree of Protection	IP65, IP40 (IEC 60529)		IP40 (IEC 60529)		IP40 (IEC 60529)	
Terminal Style	Solder terminal		Solder terminal		Solder terminal	
Accessories	Switch Guard	Yes		Yes		Yes
	Socket	Yes		Yes		Yes
	Terminal Cover	Yes		Yes		Yes
	Dust Cover	Yes		—		—
	Mounting Hole Plug	Yes		Yes		Yes
Remarks	• External current-limiting resistor type (Note)		• External current-limiting resistor type (Note)		• External current-limiting resistor type (Note)	
Approvals	 (except for pilot lights)		 (except for pilot lights)		 (except for pilot lights)	
Page	23	24	30	31	36	37

Note: LED lamps do not contain a current-limiting resistor, and external resistors must be connected.

ø16 A6 Series Switches and Pilot Lights

Light duty in short 22mm body length.

- Features IDEC's original mechanism for snap-action switching. Suitable for a wide variety of office and factory applications.
- The LED lamp contains a current-limiting resistor and a diode for protection against reverse connection.
- Degree of protection: IP40 and IP65 (IEC 60529)
- UL recognized, CSA certified, EN compliant, and CCC approved.

Applicable Standards	Mark	File No. or Organization
UL508		UL Recognition File No. E55996
CSA C22.2 No.14		CSA File No. LR 21451
EN60947-5-1		EU Low Voltage Directive
GB14048.5		CCC 2003010305027381 (switches) 2008010304288772 (pilot lights)



Contact Ratings (Contact Block)

Rated Insulation Voltage		250V			
Rated Thermal Current		3A			
Operating Voltage (AC/DC)		12V	24V	110V	220V
AC 50/60 Hz	Resistive Load	—	—	1.0A	0.5A
	Inductive Load	—	—	0.7A	0.5A
DC	Resistive Load	1.0A	1.0A	0.2A	—
	Inductive Load	0.7A	0.7A	0.5A	—
Contact Material		Gold-clad silver			

- Minimum applicable load: 5V AC/DC, 1 mA (applicable range may vary with operating conditions and load types)

Weight (example)

Weight (approx.)	AL6M-M24:	8g
	AL6M-M221:	46g
	AL6M-P4:	6g
	AL6M-P21:	45g
	AB6M-M2:	7g
	AS6M-2Y2:	9g
	AS6M-2KT2A:	21g

Specifications

Operating Temperature		-25 to +55°C (no freezing)
Storage Temperature		-30 to +80°C (no freezing)
Operating Humidity		45 to 85% RH (no condensation)
Contact Resistance		50 mΩ maximum (initial value)
Insulation Resistance		100 MΩ minimum (500V DC megger)
Dielectric Strength	Switch Unit	Between live and dead metal parts: 2,000V AC, 1 minute Between terminals of different poles: 2,000V AC, 1 minute Between terminals of the same pole: 1,000V AC, 1 minute Between contact and lamp terminals: 1,500V AC, 1 minute
	Illumination Unit	Between live part and ground: 2,000V AC, 1 minute
Vibration Resistance		Operating extremes: 5 to 55 Hz, amplitude 0.75 mm
Shock Resistance		Damage limits: 500 m/s ² (50G) Operating extremes: 200 m/s ² (20G)
Mechanical Durability (minimum operations)		Momentary: 1,000,000 operations Maintained: 100,000 operations Pushlock Turn Reset: 100,000 operations Selector Switch: 250,000 operations Key Selector Switch: 250,000 operations
Electrical Durability (minimum operations)		Other than Maintained: 100,000 operations Maintained: 50,000 operations (Switching frequency 1200 operations/h)
Degree of Protection		IP40, IP65 (IEC 60529)
Terminal Style		Solder terminal



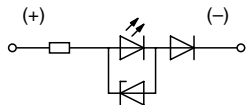
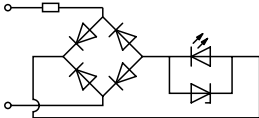





LED Lamp Ratings (LATD)

Part No.	LATD-5②	LATD-1②	LATD-2②
Lamp Base	Exclusive for A series		
Voltage Range	5V DC ±5%	12V AC/DC ±10%	24V AC/DC ±10%
Rated Voltage	5V DC	12V AC/DC	24V AC/DC
Current Draw	AC	9 mA	9 mA
	DC	8 mA	8 mA
Color Code ②	A (amber), G (green), JW (pure white), R (red), S (blue), W (white)		
Lamp Base Color	Same as illumination color (except JW - gray base)		
Voltage Marking	Die stamped on the base		
Life (reference value)	Approx. 50,000 hours (The luminance is reduced to 50% of the initial intensity when used on complete DC.)		
Internal Circuit			

- Specify a color code in place of ② in the Part No.
A (amber), G (green), JW (pure white), R (red), S (blue), W (white)
- Use a pure white (JW) LED lamp for yellow illumination.

Illuminated Pushbuttons

Package Quantity: 1









Shape	Operation	Operating Voltage	Contact	Part No.		② Illumination Color Code
				IP40	IP65	
Round AL6M  	Momentary	5V DC ±5%	SPDT	AL6M-M11 ②	AL6M-M11P ②	
			DPDT	AL6M-M21 ②	AL6M-M21P ②	
		12V AC/DC ±10%	SPDT	AL6M-M13 ②	AL6M-M13P ②	
			DPDT	AL6M-M23 ②	AL6M-M23P ②	
		24V AC/DC ±10%	SPDT	AL6M-M14 ②	AL6M-M14P ②	
			DPDT	AL6M-M24 ②	AL6M-M24P ②	
	Maintained	5V DC ±5%	SPDT	AL6M-A11 ②	AL6M-A11P ②	
			DPDT	AL6M-A21 ②	AL6M-A21P ②	
		12V AC/DC ±10%	SPDT	AL6M-A13 ②	AL6M-A13P ②	
			DPDT	AL6M-A23 ②	AL6M-A23P ②	
		24V AC/DC ±10%	SPDT	AL6M-A14 ②	AL6M-A14P ②	
			DPDT	AL6M-A24 ②	AL6M-A24P ②	
Square AL6Q  	Momentary	5V DC ±5%	SPDT	AL6Q-M11 ②	AL6Q-M11P ②	Specify a color code in place of ② in the Part No. A: amber G: green JW: pure white R: red S: blue W: white Y: yellow
			DPDT	AL6Q-M21 ②	AL6Q-M21P ②	
		12V AC/DC ±10%	SPDT	AL6Q-M13 ②	AL6Q-M13P ②	
			DPDT	AL6Q-M23 ②	AL6Q-M23P ②	
		24V AC/DC ±10%	SPDT	AL6Q-M14 ②	AL6Q-M14P ②	
			DPDT	AL6Q-M24 ②	AL6Q-M24P ②	
	Maintained	5V DC ±5%	SPDT	AL6Q-A11 ②	AL6Q-A11P ②	
			DPDT	AL6Q-A21 ②	AL6Q-A21P ②	
		12V AC/DC ±10%	SPDT	AL6Q-A13 ②	AL6Q-A13P ②	
			DPDT	AL6Q-A23 ②	AL6Q-A23P ②	
		24V AC/DC ±10%	SPDT	AL6Q-A14 ②	AL6Q-A14P ②	
			DPDT	AL6Q-A24 ②	AL6Q-A24P ②	
Rectangular AL6H  	Momentary	5V DC ±5%	SPDT	AL6H-M11 ②	AL6H-M11P ②	
			DPDT	AL6H-M21 ②	AL6H-M21P ②	
		12V AC/DC ±10%	SPDT	AL6H-M13 ②	AL6H-M13P ②	
			DPDT	AL6H-M23 ②	AL6H-M23P ②	
		24V AC/DC ±10%	SPDT	AL6H-M14 ②	AL6H-M14P ②	
			DPDT	AL6H-M24 ②	AL6H-M24P ②	
	Maintained	5V DC ±5%	SPDT	AL6H-A11 ②	AL6H-A11P ②	
			DPDT	AL6H-A21 ②	AL6H-A21P ②	
		12V AC/DC ±10%	SPDT	AL6H-A13 ②	AL6H-A13P ②	
			DPDT	AL6H-A23 ②	AL6H-A23P ②	
		24V AC/DC ±10%	SPDT	AL6H-A14 ②	AL6H-A14P ②	
			DPDT	AL6H-A24 ②	AL6H-A24P ②	
Rectangular w/three-sided barrier AL6G  	Momentary	5V DC ±5%	SPDT	AL6G-M11 ②	AL6G-M11P ②	
			DPDT	AL6G-M21 ②	AL6G-M21P ②	
		12V AC/DC ±10%	SPDT	AL6G-M13 ②	AL6G-M13P ②	
			DPDT	AL6G-M23 ②	AL6G-M23P ②	
		24V AC/DC ±10%	SPDT	AL6G-M14 ②	AL6G-M14P ②	
			DPDT	AL6G-M24 ②	AL6G-M24P ②	
	Maintained	5V DC ±5%	SPDT	AL6G-A11 ②	AL6G-A11P ②	
			DPDT	AL6G-A21 ②	AL6G-A21P ②	
		12V AC/DC ±10%	SPDT	AL6G-A13 ②	AL6G-A13P ②	
			DPDT	AL6G-A23 ②	AL6G-A23P ②	
		24V AC/DC ±10%	SPDT	AL6G-A14 ②	AL6G-A14P ②	
			DPDT	AL6G-A24 ②	AL6G-A24P ②	

- See page 7 for dimensions.
- See page 20 for marking plate size and engraving area.
- When using white lens unit (clear lens + white marking plate) with color codes A, G, R, or S, specify "W" before ② in the Part No. (without CCC marking) Example: **AL6H-M24W**②
- A pure white (JW) LED lamp is used for yellow illumination.

ø16 A6 Series Pilot Lights

Pilot Lights

Package Quantity: 1

Shape	Operating Voltage	Part No.		② Illumination Color Code
		IP40	IP65	
Round AL6M-P  	5V DC ±5%	AL6M-P1 ②	AL6M-P1P ②	Specify a color code in place of ② in the Part No. A: amber G: green JW: pure white R: red S: blue W: white Y: yellow
	12V AC/DC ±10%	AL6M-P3 ②	AL6M-P3P ②	
	24V AC/DC ±10%	AL6M-P4 ②	AL6M-P4P ②	
Square AL6Q-P  	5V DC ±5%	AL6Q-P1 ②	AL6Q-P1P ②	
	12V AC/DC ±10%	AL6Q-P3 ②	AL6Q-P3P ②	
	24V AC/DC ±10%	AL6Q-P4 ②	AL6Q-P4P ②	
Rectangular AL6H-P  	5V DC ±5%	AL6H-P1 ②	AL6H-P1P ②	
	12V AC/DC ±10%	AL6H-P3 ②	AL6H-P3P ②	
	24V AC/DC ±10%	AL6H-P4 ②	AL6H-P4P ②	
Rectangular w/three-sided barrier AL6G-P  	5V DC ±5%	AL6G-P1 ②	AL6G-P1P ②	
	12V AC/DC ±10%	AL6G-P3 ②	AL6G-P3P ②	
	24V AC/DC ±10%	AL6G-P4 ②	AL6G-P4P ②	

- See page 7 for dimensions.
- See page 20 for marking plate size and engraving area.
- When using white lens unit (clear lens + white marking plate) with color codes A, G, R, or S, specify "W" before ② in the Part No. (without CCC marking) Example: **AL6H-M24W**②
- A pure white (JW) LED lamp is used for yellow illumination.

A6 series Illuminated Pushbuttons and Pilot Lights Dimensions ø16

Dimensions (Illuminated Pushbuttons & Pilot Lights)

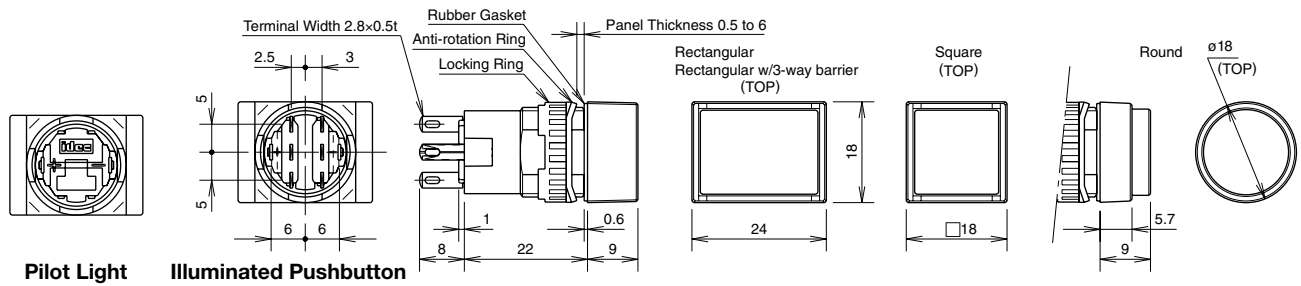

Terminal Arrangement (bottom view)

Illuminated Pushbutton

Pilot Light



With contact: NC1, NO1, C1 terminal only

Mounting Hole Layout

Round/Square

Rectangular
Rectangular w/3-way barrier











Note: Determine mounting centers to ensure easy operation.

All dimensions in mm.

ø16 A6 Series Pushbuttons

Pushbuttons

Package Quantity: 1

Shape	Button Style	Operation	Contact	Part No.		Color Code ①②
				IP40	IP65	
Round AB6M  	Button	Momentary	SPDT	AB6M-M1 ①	AB6M-M1P ①	B: black G: green R: red S: blue W: white Y: yellow
			DPDT	AB6M-M2 ①	AB6M-M2P ①	
		Maintained	SPDT	AB6M-A1 ①	AB6M-A1P ①	
			DPDT	AB6M-A2 ①	AB6M-A2P ①	
	Lens	Momentary	SPDT	AB6M-M1L ②	AB6M-M1PL ②	A: amber G: green R: red S: blue W: white Y: yellow
			DPDT	AB6M-M2L ②	AB6M-M2PL ②	
		Maintained	SPDT	AB6M-A1L ②	AB6M-A1PL ②	
			DPDT	AB6M-A2L ②	AB6M-A2PL ②	
Square AB6Q  	Button	Momentary	SPDT	AB6Q-M1 ①	AB6Q-M1P ①	B: black G: green R: red S: blue W: white Y: yellow
			DPDT	AB6Q-M2 ①	AB6Q-M2P ①	
		Maintained	SPDT	AB6Q-A1 ①	AB6Q-A1P ①	
			DPDT	AB6Q-A2 ①	AB6Q-A2P ①	
	Lens	Momentary	SPDT	AB6Q-M1L ②	AB6Q-M1PL ②	A: amber G: green R: red S: blue W: white Y: yellow
			DPDT	AB6Q-M2L ②	AB6Q-M2PL ②	
		Maintained	SPDT	AB6Q-A1L ②	AB6Q-A1PL ②	
			DPDT	AB6Q-A2L ②	AB6Q-A2PL ②	
Rectangular AB6H  	Button	Momentary	SPDT	AB6H-M1 ①	AB6H-M1P ①	B: black G: green R: red S: blue W: white Y: yellow
			DPDT	AB6H-M2 ①	AB6H-M2P ①	
		Maintained	SPDT	AB6H-A1 ①	AB6H-A1P ①	
			DPDT	AB6H-A2 ①	AB6H-A2P ①	
	Lens	Momentary	SPDT	AB6H-M1L ②	AB6H-M1PL ②	A: amber G: green R: red S: blue W: white Y: yellow
			DPDT	AB6H-M2L ②	AB6H-M2PL ②	
		Maintained	SPDT	AB6H-A1L ②	AB6H-A1PL ②	
			DPDT	AB6H-A2L ②	AB6H-A2PL ②	
Rectangular w/three-sided barrier AB6G  	Button	Momentary	SPDT	AB6G-M1 ①	AB6G-M1P ①	B: black G: green R: red S: blue W: white Y: yellow
			DPDT	AB6G-M2 ①	AB6G-M2P ①	
		Maintained	SPDT	AB6G-A1 ①	AB6G-A1P ①	
			DPDT	AB6G-A2 ①	AB6G-A2P ①	
	Lens	Momentary	SPDT	AB6G-M1L ②	AB6G-M1PL ②	A: amber G: green R: red S: blue W: white Y: yellow
			DPDT	AB6G-M2L ②	AB6G-M2PL ②	
		Maintained	SPDT	AB6G-A1L ②	AB6G-A1PL ②	
			DPDT	AB6G-A2L ②	AB6G-A2PL ②	

- Specify a color code in place of ① or ② in the Part No.
- See page 9 for dimensions.
- See page 20 for marking plate size and engraving area.
- Black is available for lens style buttons. Black lens consists of a clear lens and a black marking plate. Specify "B" in place of ② in the Part No.
Example: **AB6H-M2LB**

Dimensions

Pushbutton

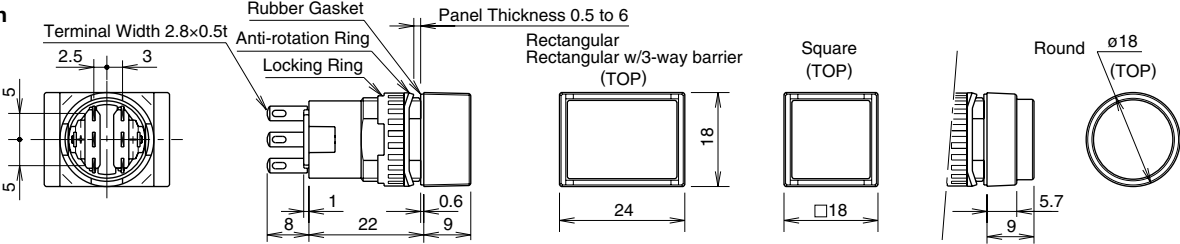

Mounting Hole Layout

Round/Square

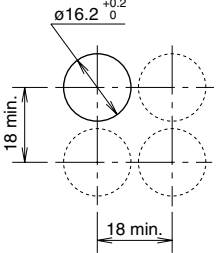

Rectangular Rectangular w/3-way barrier

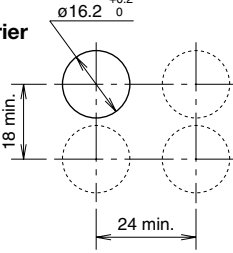

Note: Determine mounting centers to ensure easy operation.

Terminal Arrangement (bottom view)

Pushbutton

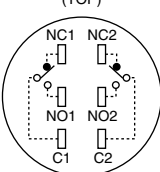

Note: SPDT has only NC1, NO1, and C1 terminals.

All dimensions in mm.

ø16 A6 Series Selector Switches

Selector Switches

Operator position can be changed by IDEC's original bezel rotating and locking system. The bezel can be locked at every 45° and bezel rotation is prevented while mounting on a panel.

Example: 3-position

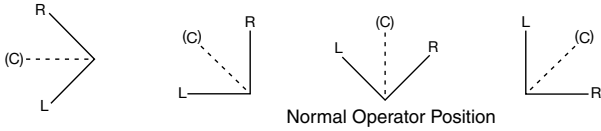

How to change the operator position

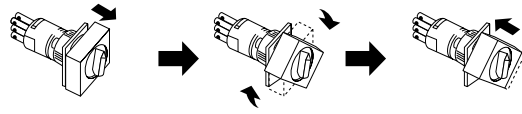













Pull out the bezel to release the lock. Rotate the bezel, and push it in at 45° intervals to lock the bezel.

Package Quantity: 1

Shape	Position	Contact	Part No.		
			IP40	IP65	
 	90° 2-position	Maintained	SPDT	AS6M-2Y1	AS6M-2Y1P
		Spring return from right to left	DPDT	AS6M-2Y2	AS6M-2Y2P
	45° 3-position	Maintained	SPDT	AS6M-21Y1	AS6M-21Y1P
		Spring return from right to center	DPDT	AS6M-21Y2	AS6M-21Y2P
		Spring return from left to center	DPDT	AS6M-3Y2	AS6M-3Y2P
		Spring return two-way	DPDT	AS6M-32Y2	AS6M-32Y2P
 	90° 2-position	Maintained	SPDT	AS6Q-2Y1	AS6Q-2Y1P
		Spring return from right to left	DPDT	AS6Q-2Y2	AS6Q-2Y2P
	45° 3-position	Maintained	SPDT	AS6Q-21Y1	AS6Q-21Y1P
		Spring return from right to center	DPDT	AS6Q-21Y2	AS6Q-21Y2P
		Spring return from left to center	DPDT	AS6Q-3Y2	AS6Q-3Y2P
		Spring return two-way	DPDT	AS6Q-32Y2	AS6Q-32Y2P
 	90° 2-position	Maintained	SPDT	AS6H-2Y1	AS6H-2Y1P
		Spring return from right to left	DPDT	AS6H-2Y2	AS6H-2Y2P
	45° 3-position	Maintained	SPDT	AS6H-21Y1	AS6H-21Y1P
		Spring return from right to center	DPDT	AS6H-21Y2	AS6H-21Y2P
		Spring return from left to center	DPDT	AS6H-3Y2	AS6H-3Y2P
		Spring return two-way	DPDT	AS6H-32Y2	AS6H-32Y2P

• Bezel: black

• Knob: black

		Contact Operation		
Position	Operation	Left	Center	Right
90° 2-position	Maintained	SPDT		
			—	
	Spring return from right	DPDT		
			—	
45° 3-position	Maintained	DPDT		
	Spring return from right			
	Spring return from left			
	Two-way return			

Dimensions

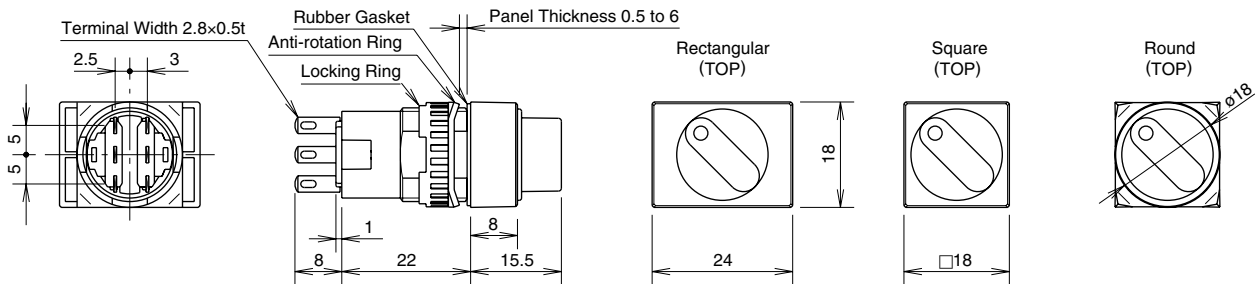

Terminal Arrangement (bottom view) (Selector Switch)

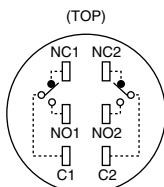

SPDT has NC1, NO1, and C1 only.

Mounting Hole Layout

Round/Square

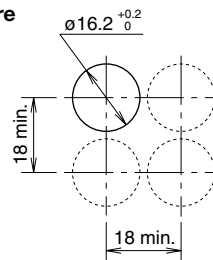

Rectangular

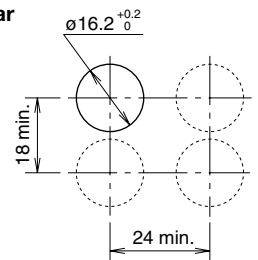



















Note: Determine mounting centers to ensure easy operation.

All dimensions in mm.

Key Selector Switches

Package Quantity: 1

Shape	Position	Operation	Key Retained at ●	Contact	Part No.			
					IP40	IP65		
 <p>Disc tumbler key</p>  <p>Wave key</p> 	90° 2-position	Maintained	A		SPDT	AS6M-2K□1A	AS6M-2K□1PA	
					DPDT	AS6M-2K□2A	AS6M-2K□2PA	
			B		SPDT	AS6M-2K□1B	AS6M-2K□1PB	
					DPDT	AS6M-2K□2B	AS6M-2K□2PB	
			C		SPDT	AS6M-2K□1C	AS6M-2K□1PC	
					DPDT	AS6M-2K□2C	AS6M-2K□2PC	
		Spring return from right	B			SPDT	AS6M-21K□1B	AS6M-21K□1PB
					DPDT	AS6M-21K□2B	AS6M-21K□2PB	
	A				DPDT	AS6M-3K□2A	AS6M-3K□2PA	
	B				DPDT	AS6M-3K□2B	AS6M-3K□2PB	
	C				DPDT	AS6M-3K□2C	AS6M-3K□2PC	
	D				DPDT	AS6M-3K□2D	AS6M-3K□2PD	
		Maintained	E			DPDT	AS6M-3K□2E	AS6M-3K□2PE
					DPDT	AS6M-3K□2G	AS6M-3K□2PG	
					DPDT	AS6M-3K□2H	AS6M-3K□2PH	
	B				DPDT	AS6M-31K□2B	AS6M-31K□2PB	
	D				DPDT	AS6M-31K□2D	AS6M-31K□2PD	
	G				DPDT	AS6M-31K□2G	AS6M-31K□2PG	
		Spring return from right	D			DPDT	AS6M-32K□2C	AS6M-32K□2PC
					DPDT	AS6M-32K□2D	AS6M-32K□2PD	
					DPDT	AS6M-32K□2H	AS6M-32K□2PH	
		Spring return from left	H			DPDT	AS6M-33K□2D	AS6M-33K□2PD
	Spring return two-way	D			DPDT	AS6M-33K□2D	AS6M-33K□2PD	

- Specify the key code in place of □ in the Part No.: T (disc tumbler key), S (wave key)
- For contact operation, see page 14.
- Key is retained at ● positions and removable at ○ positions.
- Two keys are supplied.
- The front of key cylinder is made of metal.
- For disc tumbler key, only one type of key is available.
- For wave key, besides the standard key (key number 0H), six other keys are also available. To order other keys, specify the key number as shown below:

Example: **AS6M-2KS1PA-1H**

























(blank): Standard key (0H)
 1H to 2H: Reversible key
 3H to 6H: Non-reversible key

Note:
 Key number is indicated on the key cylinder.
 Standard keys do not have a key number indication.

ø16 A6 Series Key Selector Switches

Key Selector Switches

Package Quantity: 1

Shape	Position	Operation	Key Retained at ●	Contact	Part No.				
					IP40	IP65			
Square AS6Q  Disc tumbler key  Wave key 	90° 2-position	Maintained	A		SPDT	AS6Q-2K□1A	AS6Q-2K□1PA		
					DPDT	AS6Q-2K□2A	AS6Q-2K□2PA		
			B		SPDT	AS6Q-2K□1B	AS6Q-2K□1PB		
					DPDT	AS6Q-2K□2B	AS6Q-2K□2PB		
			C		SPDT	AS6Q-2K□1C	AS6Q-2K□1PC		
					DPDT	AS6Q-2K□2C	AS6Q-2K□2PC		
		Spring return from right		B		SPDT	AS6Q-21K□1B	AS6Q-21K□1PB	
					DPDT	AS6Q-21K□2B	AS6Q-21K□2PB		
	A				DPDT	AS6Q-3K□2A	AS6Q-3K□2PA		
	B				DPDT	AS6Q-3K□2B	AS6Q-3K□2PB		
	C				DPDT	AS6Q-3K□2C	AS6Q-3K□2PC		
	D				DPDT	AS6Q-3K□2D	AS6Q-3K□2PD		
		45° 3-position	Maintained	E		DPDT	AS6Q-3K□2E	AS6Q-3K□2PE	
	G				DPDT	AS6Q-3K□2G	AS6Q-3K□2PG		
	H				DPDT	AS6Q-3K□2H	AS6Q-3K□2PH		
	B				DPDT	AS6Q-31K□2B	AS6Q-31K□2PB		
	D				DPDT	AS6Q-31K□2D	AS6Q-31K□2PD		
	G				DPDT	AS6Q-31K□2G	AS6Q-31K□2PG		
			Spring return from right		C		DPDT	AS6Q-32K□2C	AS6Q-32K□2PC
	D					DPDT	AS6Q-32K□2D	AS6Q-32K□2PD	
H					DPDT	AS6Q-32K□2H	AS6Q-32K□2PH		
	Spring return from left			C		DPDT	AS6Q-32K□2C	AS6Q-32K□2PC	
D					DPDT	AS6Q-32K□2D	AS6Q-32K□2PD		
H					DPDT	AS6Q-32K□2H	AS6Q-32K□2PH		
	Spring return two-way		D		DPDT	AS6Q-33K□2D	AS6Q-33K□2PD		

- Specify the key code in place of □ in the Part No.: T (disc tumbler key), S (wave key)
- For contact operation, see page 14.
- Key is retained at ● positions and removable at ○ positions.
- Two keys are supplied.
- The front of key cylinder is made of metal.
- For disc tumbler key, only one type of key is available.
- For wave key, besides the standard key (key number 0H), six other keys are also available. To order other keys, specify the key number as shown below:





















Example: **AS6M-2KS1PA-1H**

(blank): Standard key (0H)
 1H to 2H: Reversible key
 3H to 6H: Non-reversible key

Note:
 Key number is indicated on the key cylinder.
 Standard keys do not have a key number indication.

Key Selector Switches

Package Quantity: 1

Shape	Position	Operation	Key Retained at ●	Contact	Part No.			
					IP40	IP65		
 <p>Disc tumbler key</p>  <p>Wave key</p> 	90° 2-position	Maintained	A		SPDT	AS6H-2K□1A	AS6H-2K□1PA	
					DPDT	AS6H-2K□2A	AS6H-2K□2PA	
			B		SPDT	AS6H-2K□1B	AS6H-2K□1PB	
					DPDT	AS6H-2K□2B	AS6H-2K□2PB	
			C		SPDT	AS6H-2K□1C	AS6H-2K□1PC	
					DPDT	AS6H-2K□2C	AS6H-2K□2PC	
		Spring return from right	Maintained	B		SPDT	AS6H-21K□1B	AS6H-21K□1PB
					DPDT	AS6H-21K□2B	AS6H-21K□2PB	
	A				DPDT	AS6H-3K□2A	AS6H-3K□2PA	
	B				DPDT	AS6H-3K□2B	AS6H-3K□2PB	
	C				DPDT	AS6H-3K□2C	AS6H-3K□2PC	
	D				DPDT	AS6H-3K□2D	AS6H-3K□2PD	
		Spring return from right	Spring return from right	E		DPDT	AS6H-3K□2E	AS6H-3K□2PE
	G				DPDT	AS6H-3K□2G	AS6H-3K□2PG	
	H				DPDT	AS6H-3K□2H	AS6H-3K□2PH	
	B				DPDT	AS6H-31K□2B	AS6H-31K□2PB	
	D				DPDT	AS6H-31K□2D	AS6H-31K□2PD	
	G				DPDT	AS6H-31K□2G	AS6H-31K□2PG	
		Spring return from left	Spring return from left	C		DPDT	AS6H-32K□2C	AS6H-32K□2PC
	D				DPDT	AS6H-32K□2D	AS6H-32K□2PD	
H				DPDT	AS6H-32K□2H	AS6H-32K□2PH		
	Spring return two-way	Spring return two-way	D		DPDT	AS6H-33K□2D	AS6H-33K□2PD	

- Specify the key code in place of □ in the Part No.: T (disc tumbler key), S (wave key)
- For contact operation, see page 14.
- Key is retained at ● positions and removable at ○ positions.
- Two keys are supplied.
- The front of key cylinder is made of metal.
- For disc tumbler key, only one type of key is available.
- For wave key, besides the standard key (key number 0H), six other keys are also available. To order other keys, specify the key number as shown below:

Example: **AS6M-2KS1PA-1H**

(blank): Standard key (0H)
 1H to 2H: Reversible key
 3H to 6H: Non-reversible key

Note:
 Key number is indicated on the key cylinder.
 Standard keys do not have a key number indication.

ø16 A6 Series Key Selector Switches

Contact Operation

Operator Position & Contact Operation (Top View)					
Positions		Contact	↙ Left	↑ Center	↘ Right
90° 2-position	Maintained	SPDT	NO NC	—	NO NC
	Spring return from right	DPDT	Left Contact NO NC Right Contact NO NC	—	Left Contact NO NC Right Contact NO NC
45° 3-position	Maintained	DPDT	Left Contact NO NC Right Contact NO NC	Left Contact NO NC Right Contact NO NC	Left Contact NO NC Right Contact NO NC
	Spring return from right				
	Spring return from left				
	Spring return two-way				

Dimensions

Disc Tumbler Key

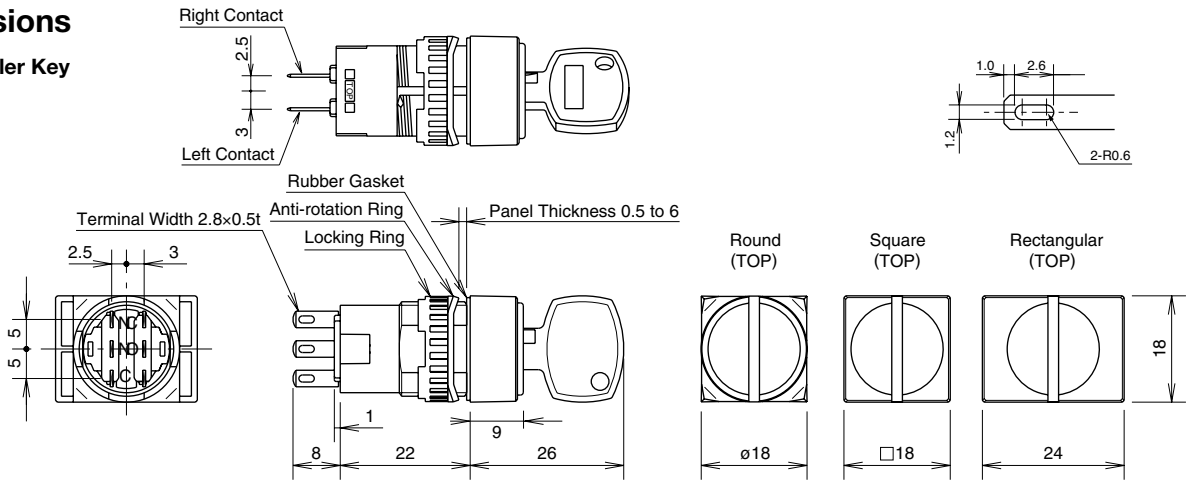

Wave Key

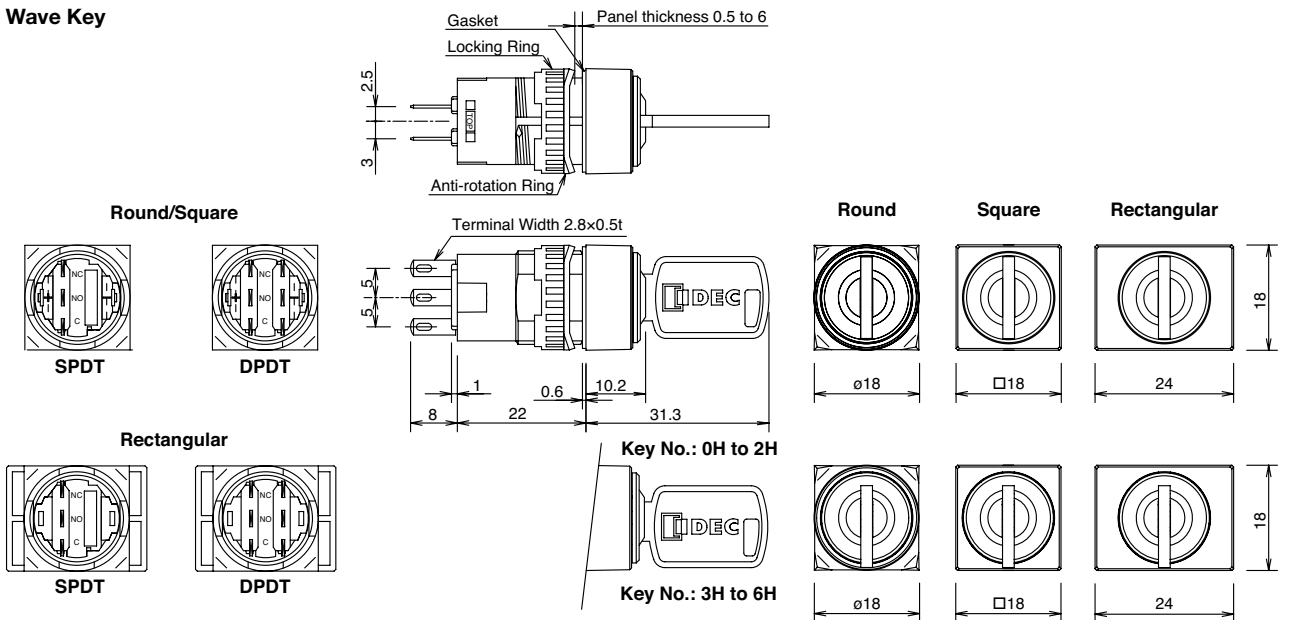

Terminal Arrangement (bottom view) (Key Selector Switch)

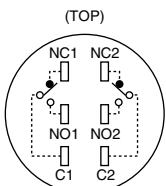





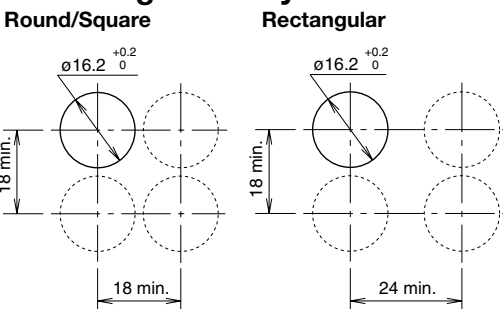





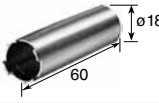

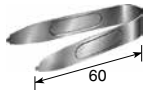
SPDT has NC1, NO1, and C1 only.

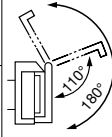
Mounting Hole Layout

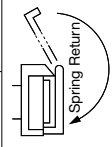

Note: Determine mounting centers to ensure easy operation.

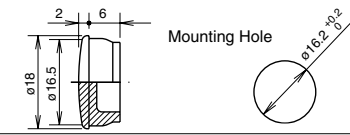
All dimensions in mm.

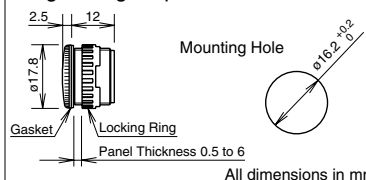
Accessories						
Shape	Material	Part No.	Ordering No.	Package Quantity	Remarks	
Locking Ring Wrench 	Metal (nickel-plated brass)	MT-001	MT-001	1	<ul style="list-style-type: none"> Used to tighten the locking ring when installing A6 series into a panel. 	
Lamp Holder Tool 	Rubber	OR-77	OR-77	1	<ul style="list-style-type: none"> Used to install and remove the LED lamps. 	
Lens Removal Tool 	Stainless Steel	MT-101	MT-101	1	<ul style="list-style-type: none"> Used to install and remove lenses and buttons. 	
Switch Guard <div style="display: flex; justify-content: space-between;"> <div style="width: 20%;"> <p>[Remains open] For pushbuttons, illuminated pushbuttons</p>  </div> <div style="width: 30%;"> <p>For round/square units (110°, 180°)</p> <p>For rectangular units (remains 110°, 180°)</p>  </div> <div style="width: 20%;"> <p>[Spring return] For pushbuttons, illuminated pushbuttons</p>  </div> <div style="width: 30%;"> <p>For round/square units (180°)</p> <p>For rectangular units (180°)</p>  </div> </div>	Guard (polyacetal) Cover (polyarylate)	LB9Z-K2	LB9Z-K2	1	<ul style="list-style-type: none"> Degree of protection: IP40 Used to protect pushbuttons from inadvertent operation. 	
		LB9Z-K3P	LB9Z-K3P	1	<ul style="list-style-type: none"> Degree of protection: IP65 Used to protect pushbuttons from inadvertent operation. 	
		AL-K6S	AL-K6S	1	<ul style="list-style-type: none"> Degree of protection: IP40 Used to protect pushbuttons from inadvertent operation. 	
		AL-K6SP	AL-K6SP	1	<ul style="list-style-type: none"> Degree of protection: IP65 (when used with IP65 control units) Used to protect pushbuttons from inadvertent operation. 	
		AL-KH6S	AL-KH6S	1	<ul style="list-style-type: none"> Degree of protection: IP40 Used to protect pushbuttons from inadvertent operation. 	
		AL-KH6SP	AL-KH6SP	1	<ul style="list-style-type: none"> Degree of protection: IP65 (when used with IP65 control units) Used to protect pushbuttons from inadvertent operation. 	
Dust Cover 	For round units	Translucent cover: elastomer Black part: polypropylene	AL-D6	AL-D6	1	<ul style="list-style-type: none"> When mounting the units with the dust covers installed, refer to mounting hole layout on page 17. Operating temperature: -10 to +55°C
	For square units		AL-DQ6	AL-DQ6	1	
	For rectangular units		AL-DH6	AL-DH6	1	
Terminal Cover 		Polyamide (white) See page 17 for dimensions.	AL-V6	AL-V6PN10	10	<ul style="list-style-type: none"> When wiring the terminals, insert the lead wires into the terminal cover holes before soldering. Terminal cover is not attached and must be ordered separately.
Socket 	Solder Terminal	See page 17 for dimensions.	AL-C6	AL-C6	1	<ul style="list-style-type: none"> Plugs on the rear of the A series.
	PC Board Terminal		AL-C6V	AL-C6V	1	
Mounting Hole Plug 	Rubber	Nitril rubber (black)	AL-B6	AL-B6PN05	5	<ul style="list-style-type: none"> Degree of protection: IP65 
Mounting Hole Plug 	Metal	Plug: metal (diecast) Locking ring: polyacetal Gasket: nitrile	AL-BM6	AL-BM6	1	<ul style="list-style-type: none"> Degree of protection: IP65 Tightening torque: 0.1 to 0.29 N-m.  <p style="text-align: right; font-size: small;">All dimensions in mm.</p>

Dimensions

Switch Guard

[Remains open]

**For round/square units (Degree of protection: IP40)
LB9Z-K2**

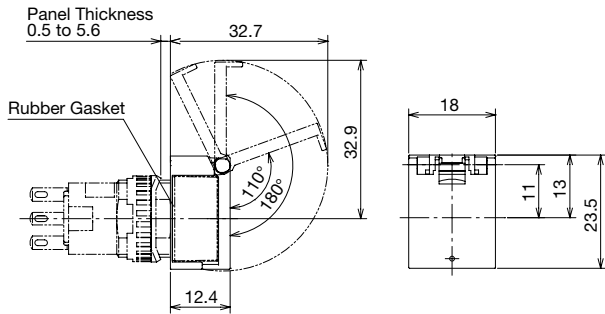

**For rectangular units (Degree of protection: IP65)
LB9Z-K3P**

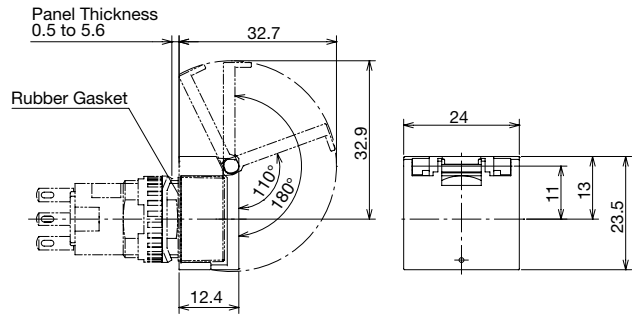

[Spring return]

**For round/square units (Degree of protection: IP40)
AL-K6S**

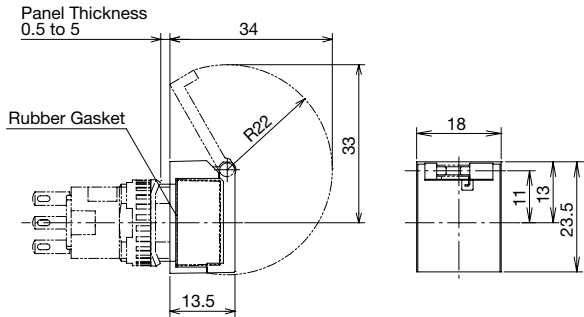

**For rectangular units (Degree of protection: IP40)
AL-KH6S**

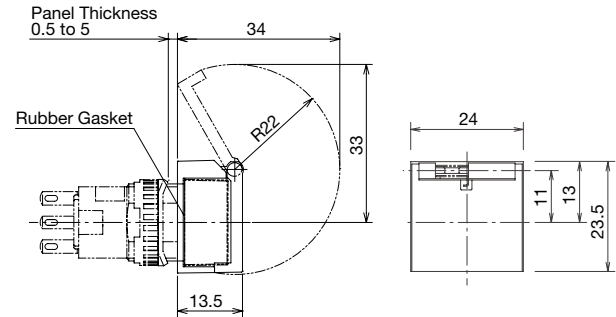

**For round/square units (Degree of protection: IP65)
AL-K6SP**

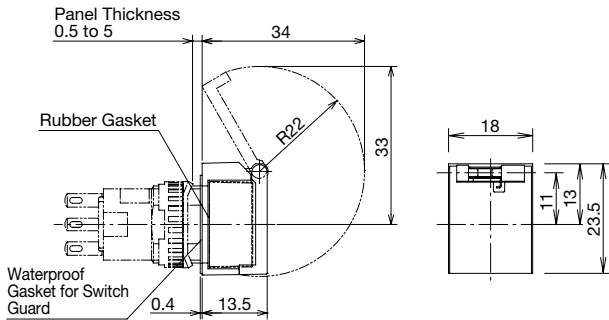

**For rectangular units (Degree of protection: IP65)
AL-KH6SP**

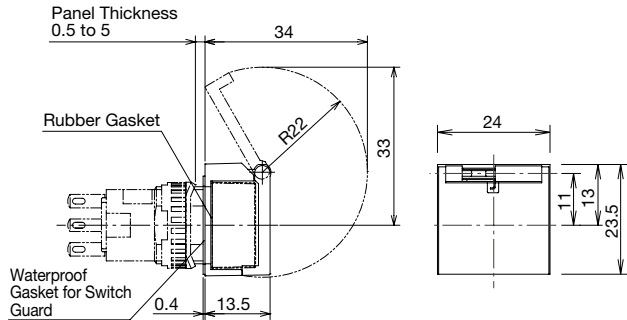

Socket

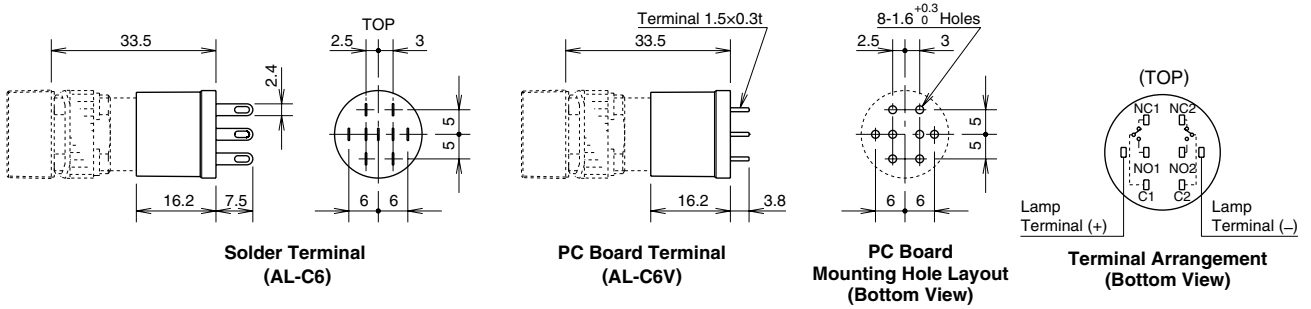

Terminal Cover

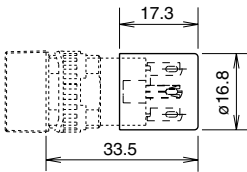

Note: When wiring the terminals, insert the lead wires into the terminal cover holes before soldering.

Dust Cover

For Round Units (AL-D6)

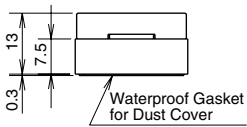
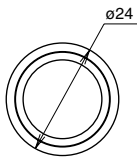

Waterproof Gasket for Dust Cover

For Square Units (AL-DQ6)

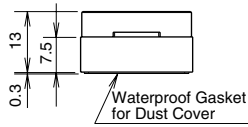
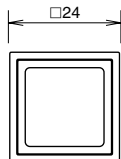

Waterproof Gasket for Dust Cover

For Rectangular Units (AL-DH6)

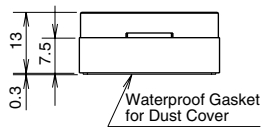
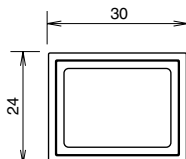

Waterproof Gasket for Dust Cover

Mounting Hole Centers

Round/Square Units

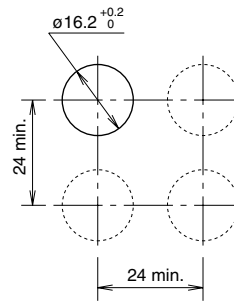

Rectangular Units

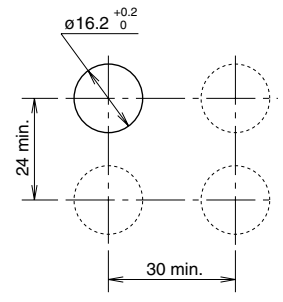

Large Lens and Large Button

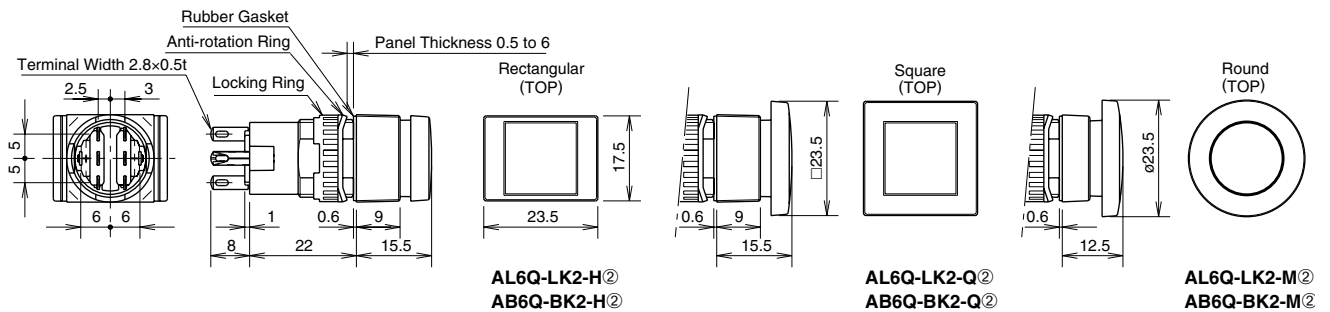

All dimensions in mm.

ø16 A6 Series Accessories

Grip Style Enabling Switch Housing

The following A6 series switches can be installed on the HE9Z-GSH51 grip style enabling switch housing to be used as hand-held switches.

- AB6M pushbutton (IP65)
- AS6M selector switch (IP65)
- AS6M key selector switch (IP65)
(illuminated pushbutton and pilot light cannot be installed)

Part No.	Ordering No.	Package Quantity
HE9Z-GSH51	HE9Z-GSH51	1

Specifications

Applicable Cable	Outside diameter ø4.5 to 10 mm
Conduit Port Size	M16 (cable gland is supplied with the grip style enabling switch housing)
Weight (approx.)	65g (grip style enabling switch housing only)

- The above specifications are for the grip style enabling switch housing only. Make sure to check the specifications of switches also.
- For the detailed specifications of grip style enabling switch housing, A6 series switches, and HE5B enabling switch, see their catalogs.



Notes:

- The HE9Z-GSH51 grip style enabling switch housing does not include the A6 series switch or HE5B enabling switch, and they must be ordered separately.
- The switches must be installed and wired to the HE9Z-GSH51 grip style enabling switch housing by the user. For information on wiring, see the instruction sheet supplied with the HE9Z-GSH51.

Dimensions

HE9Z-GSH51

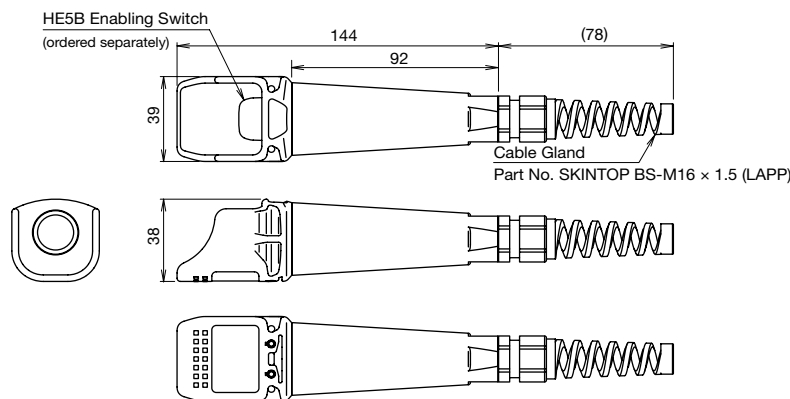

HE9Z-GSH51 + HE5B Construction

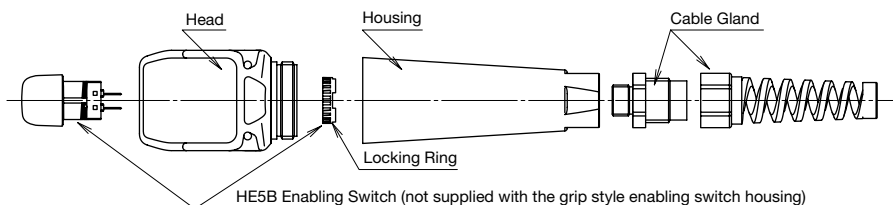

- Anti-rotation ring is not required when installing the HE5B enabling switch on the HE9Z-GSH51 grip style enabling switch housing. Use the locking ring only.





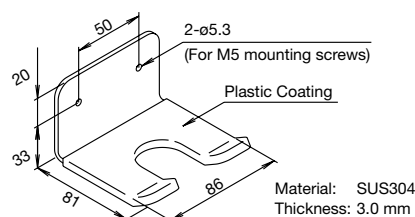



Mounting Bracket

Part No: HE9Z-GH1



All dimensions in mm.

Maintenance Parts

Shape		Specification	Part No.	Ordering No.	Package Quantity	Remarks														
Lens 	Round	Polyarylate	AL6M-L②	AL6M-L②PN05	5	Specify a color code in place of ② in the Part No. A (amber), C (clear), G (green) R (red), S (blue), Y (yellow) • Use a C (clear) lens for W (white) and JW (pure white) illumination.														
	Square		AL6Q-L②	AL6Q-L②PN05																
	Rectangular		AL6H-L②	AL6H-L②PN05																
Button 	Round	Polyarylate	AB6M-B①	AB6M-B①PN05		Specify a color code in place of ① in the Part No. B (black), G (green), R (red) S (blue), W (white), Y (yellow)														
	Square		AB6Q-B①	AB6Q-B①PN05																
	Rectangular		AB6H-B①	AB6H-B①PN05																
Marking Plate 	Round	Acrylic	White	AL6M-W		AL6M-WPN05														
			Black	AL6M-B		AL6M-BPN05														
	Square		White	AL6Q-W		AL6Q-WPN05														
			Black	AL6Q-B	AL6Q-BPN05															
	Rectangular		White	AL6H-W	AL6H-WPN05															
			Black	AL6H-B	AL6H-BPN05															
Large Lens Unit 	Round (installed on round units)	Translucent color lens	AL6M-LK2-M②	AL6M-LK2-M②	1	<ul style="list-style-type: none"> Specify a color code in place of ② in the Part No. Degree of protection: IP65 <p>② Color Code</p> <table border="1"> <thead> <tr> <th>Translucent Color Lens</th> <th>Opaque Button</th> </tr> </thead> <tbody> <tr> <td>A (amber)</td> <td>B (black)</td> </tr> <tr> <td>G (green)</td> <td>G (green)</td> </tr> <tr> <td>R (red)</td> <td>R (red)</td> </tr> <tr> <td>S (blue)</td> <td>S (blue)</td> </tr> <tr> <td>W (white)</td> <td>W (white)</td> </tr> <tr> <td>Y (yellow)</td> <td>Y (yellow)</td> </tr> </tbody> </table> <ul style="list-style-type: none"> See page 17 for dimensions. 	Translucent Color Lens	Opaque Button	A (amber)	B (black)	G (green)	G (green)	R (red)	R (red)	S (blue)	S (blue)	W (white)	W (white)	Y (yellow)	Y (yellow)
		Translucent Color Lens	Opaque Button																	
	A (amber)	B (black)																		
	G (green)	G (green)																		
	R (red)	R (red)																		
	S (blue)	S (blue)																		
W (white)	W (white)																			
Y (yellow)	Y (yellow)																			
Opaque button	AB6M-BK2-M②	AB6M-BK2-M②																		
Square (installed on square units)	Translucent color lens	AL6Q-LK2-Q②	AL6Q-LK2-Q②																	
	Opaque button	AB6Q-BK2-Q②	AB6Q-BK2-Q②																	
Rectangular (installed on square units)	Translucent color lens	AL6Q-LK2-H②	AL6Q-LK2-H②																	
	Opaque button	AB6Q-BK2-H②	AB6Q-BK2-H②																	
Locking Ring 		Polyacetal	HA9Z-LN	HA9Z-LNPN10	10	• Black														
Anti-rotation Ring 		Stainless Steel	LB9Z-LP1	LB9Z-LP1PN10																
Spare key 	Key selector (disc tumbler key)	Brass with nickel plating	AS6-SK-132	AS6-SK-132PN02	2	• Thickness 1.8 mm														
Spare Key 	Key selector (wave key)	Diecast zinc alloy (nickel-plated)	LA9Z-SK-□	LA9Z-SK-□PN02	2	<ul style="list-style-type: none"> Specify a key number in place of □ in the Part No. 0H: Standard key (reversible) 1H to 2H: Reversible key 3H to 6H: Non-reversible key 														
Gasket 		Rubber	AP6M-WM	AP6M-WMPN10		10														

ø16 A6 Series Maintenance Parts

LED Lamps

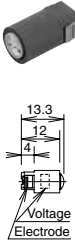
Dimensions	Operating Voltage	Current Draw		Part No.	Ordering No.	② Illumination Color Code	Package Quantity	Base
		AC	DC					
	5V DC ±5%	—	8 mA	LATD-5②	LATD-5②	Specify a color code in place of ② in the Ordering No.	1	Exclusive for A6 series
					LATD-5②PN10		10	
	6V DC ±5%	7 mA (G, S, JW) 8 mA (A, R, W)	5 mA (G, S, JW) 6 mA (A, R, W)	LATD-6②	LATD-6②	1		
					LATD-6②PN10	10		
	12V AC/DC ±10%	9 mA	8 mA	LATD-1②	LATD-1②	A: amber G: green JW: pure white R: red S: blue W: white	1	
					LATD-1②PN10	10		
	24V AC/DC ±10%	9 mA	8 mA	LATD-2②	LATD-2②		1	
					LATD-2②PN10	10		

- Use a pure white (JW) LED lamp for yellow illumination

Safety Precautions

- Turn off the power to A series before starting installation, removal, wiring, maintenance, and inspection of the units. Failure to turn power off may cause electrical shocks or fire hazard.
- To avoid a burn on your hand, use the lamp holder tool when replacing lamps.
- For wiring, use wires of a proper size to meet the voltage and current requirements. Failure to tighten terminal screws may cause overheating and create a fire hazard.

Operating Instructions

Replacement of Lens and Marking Plate

Removal

Remove the lens assembly (color lens, marking plate, lens holder, and spring) by holding the color lens recesses with the Lens Removal Tool (MT-101) and pulling it out. Remove the marking plate by disengaging the latches between the color lens and lens holder. The marking plate must be engraved on the front side as shown at right. When using a color film, insert it between the color lens and marking plate.

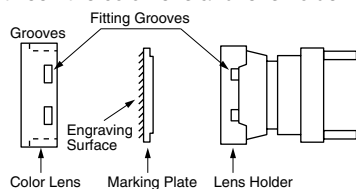

Installation

Place the marking plate on the lens holder in the correct direction, and press the color lens onto the lens holder to engage the latches. Put the spring on the lens holder and insert the lens holder into the housing in the correct direction.

Marking

For A series illuminated pushbuttons, legends and symbols can be engraved on the built-in marking plates, or printed film can be inserted under the lens for labelling purposes.

Marking Plate & Engraving Area

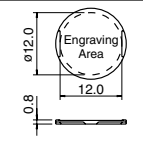
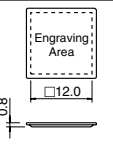
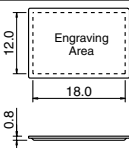
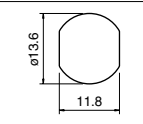
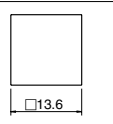
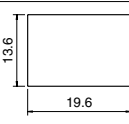
	Round	Square	Rectangular
Built-in Marking Plate and Engraving Area	 <p>Engraving Area: ø12.0, 12.0, 0.8</p>	 <p>Engraving Area: 12.0, 0.8</p>	 <p>Engraving Area: 12.0, 18.0, 0.8</p>
	<ul style="list-style-type: none"> • Engraving must be made on the engraving area within 0.5mm deep. • The marking plate is made of white acrylic resin. 		
Applicable Marking Film (not supplied)	 <p>ø13.6, 11.8</p>	 <p>13.6</p>	 <p>13.6, 19.6</p>
	<ul style="list-style-type: none"> • Thickness = 0.1 mm × 1 film • Recommended film material: polyester 		

Replacing the LED Lamp

Removal

Use the lamp holder tool (OR-77) to remove lamps. Do not use pliers.

Installation

Use the lamp holder tool (OR-77) to install lamps. Note the correct side of the tool for removal or installation.

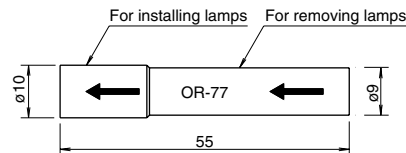

All dimensions in mm.

Panel Mounting

When mounting the units into a panel, use the optional locking ring wrench (MT-001) to tighten the locking ring. Do not use pliers. Tightening torque must not exceed 0.88 N·m. Excessive tightening will damage the locking ring.

Wiring

Solder the terminal at 350°C within 3 seconds using a 60W soldering iron. Sn-Ag-Cu is recommended when using lead-free solder. When soldering, do not touch the unit with the soldering iron. Also ensure that no tensile force is applied to the terminal. Do not bend the terminal or apply excessive force to the terminal. Use a non-corrosive rosin flux.

Installing the Socket

Install the socket on the unit with the TOP markings on the unit and the socket placed in the same direction.

Switch Guard

IP65 (IEC 60529) switch guards must be used with IP65 (IEC 60529) units only. Even if IP65 type switch guards are installed, enclosed type (IP40) units are not made waterproof.

Item	Switch Guard		
		IP65 (IEC 60529)	IP40 (IEC 60529)
Switch	IP65	IP65	IP40
	IP40	IP40	IP40

Opening/closing the Switch Guard (LB9Z-K2, LB9Z-K3P)

When opening/closing the switch guard while the switch guard is not installed on a panel, make sure to hold the hinge. Holding the base might result in damage. Also do not apply force on the guard in other than open/close directions, otherwise the hinge may be damaged.

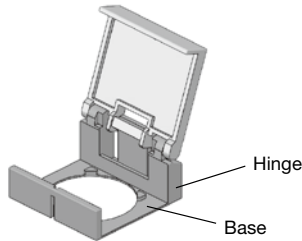

Operating Voltage of LED Lamps

The operating voltage of 5V DC is measured at complete DC.

Other Notes

Close Proximity Mounting

When mounting pilot lights or illuminated pushbuttons collectively or lighting them continuously, heat may cause the ambient temperature to rise above the rated operating temperature. When the mounting panel is not made of metal or when the units are mounted in an enclosed panel, provide for ventilation or lower the operating voltage.

Replacement of Buttons (Illuminated/Non-illuminated)

Do not replace buttons of maintained action units while the button is in the locked position. Replacing the button in the locked position may damage the internal mechanism. Be sure to release the button before replacing.

Operating and Storage Environment

1. Make sure that the operating/storage temperature and humidity are within the ratings.
2. Do not use enclosed type units in an environment subject to oil, water or dust accumulation. In such an area, use the waterproof/oiltight units (IP65).

Microswitch Contacts

Do not connect NO and NC contacts of a microswitch to different voltages or different power sources to prevent a dead short-circuit.

IP65 Units

IP65 units are evaluated by conventional cutting and cooling oils, and can not be used with some special oils. Contact IDEC for resistance against specific oils.

Selector Switches with Key



Observe the following instructions to prevent malfunction or damage.

- Insert the key to the bottom of the key hole.
- Do not remove the key from any key retained position.
- Besides the standard key (key number 0H), six other key numbers are available. Use a key of the matching number with the key cylinder. The standard key does not have a key number indication.
- Keys are available in two types.
Key numbers 0H (standard), 1H, and 2H are reversible keys which can be inserted in two ways.
Key numbers 3H, 4H, 5H, and 6H are non-reversible keys. Make sure of correct insertion direction.

ø12 A2 Series Switches and Pilot Lights

Short 22-mm-long body miniature switches and pilot lights with bright LED illumination face and snap-action switching.

- Degree of protection: IP40 and IP65 (IEC 60529)
- All series have terminals on the same plane.
- UL recognized, CSA certified

Applicable Standards	Mark	File No. or Organization
UL508		UL Recognition File No. E55996
CSA C22.2 No.14		CSA File No. LR 21451
GB14048.5		CCC No.2013010305647324 (except for pilot lights)



Contact Ratings (Contact Block)

Rated Insulation Voltage		250V		
Rated Thermal Current		3A		
Operating Voltage (AC/DC)		24V	110V	220V
AC 50/60 Hz	Resistive Load	–	1.0A	0.5A
	Inductive Load	–	0.7A	0.5A
DC	Resistive Load	1.0A	0.2A	–
	Inductive Load	0.7A	0.1A	–
Contact Material		Silver		

- Minimum applicable load: 5V AC/DC, 3 mA
(applicable range may vary with operating conditions and load types)

Weight

Weight (approx.)	AL2M-M11: 4g
	AL2M-P1: 4g
	AB2M-M1: 4g

Specifications

Operating Temperature		–25 to +55°C (no freezing)
Storage Temperature		–30 to +80°C (no freezing)
Operating Humidity		45 to 85% RH (no condensation)
Contact Resistance		50 mΩ maximum (initial value)
Insulation Resistance		100 MΩ minimum (500V DC megger)
Dielectric Strength	Switch Unit	Between live and dead metal parts: 2,000V AC, 1 minute Between terminals of different poles: 2,000V AC, 1 minute Between terminals of the same pole: 1,000V AC, 1 minute Between contact and lamp terminals: 1,500V AC, 1 minute
	Illumination Unit	Between live part and ground: 2,000V AC, 1 minute
Vibration Resistance		Damage limits, Operating extremes: 5 to 55 Hz, amplitude 0.75 mm
Shock Resistance		Damage limits: 500 m/s ² (50G) Operating extremes: 200 m/s ² (20G)
Mechanical Durability (minimum operations)		Momentary: 200,000 operations Maintained: 100,000 operations
Electrical Durability (minimum operations)		Momentary: 100,000 operations Maintained: 50,000 operations (Switching frequency 1200 operations/h)
Degree of Protection		IP40, IP65 (IEC 60529)

LED Lamp Ratings (LAD-S)

Built-in LED Part No.	LAD-SA	LAD-SG	LAD-SR	LAD-SY
Lamp Base	Exclusive for A series			
Forward Current (If)	20 mA			
Forward Voltage (Vf) (nominal)	2.2V	2.1V	1.7V	2.2V
Reverse Voltage (Vr)	4V			
Illumination Color	A	G	R	Y
LED Lamp Color	Amber Clear	Yellow Diffused	Red Clear	Yellow Clear
Applicable Lens Color	Amber	Green	Red	Yellow and White
Base Plastic Color	Red			
LED Lamp Life (reference value)	Approx. 50,000 hours (The illuminance reduces to 50% of the initial intensity when used on complete DC.)			
Operating Voltage & External Current-limiting Resistor (recommended value) (Note)	5V DC: 150Ω, 1/2W 6V DC: 200Ω, 1/2W 12V DC: 510Ω, 1W 24V DC: 1.1 kΩ, 1W			
Internal Circuit				

Note: When LED lamps are used on voltages other than the above, external resistor value R is determined by the following formula:

$$R = (\text{operating voltage} - V_f) / I_f$$



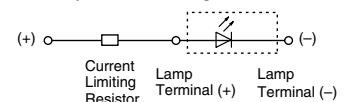



- LED lamps do not have a current-limiting resistor, and external resistors of recommended values for each voltage must be provided. Connect a current-limiting resistor in series, otherwise LED lamps will be damaged. Because no protection diode is contained, ensure the correct polarity is observed.



A2 Series Illuminated Pushbuttons and Pilot Lights ø12

Illuminated Pushbuttons & Pilot Lights

Package Quantity: 1

Shape	Operation	Contact	Part No.		② Lens Color Code	LED Lamp
			IP40	IP65		Part No., Rated Current (External Resistor Recommended Value)
Round AL2M   (except for pilot lights)	Momentary	SPDT	AL2M-M11 ②	AL2M-M11P ②	Specify a color code in place of ② in the Part No. A: amber G: green R: red W: white Y: yellow	A: LAD-SA G: LAD-SG R: LAD-SR W/Y: LAD-SY Rated Current: 20 mA 5V DC: 150Ω, 1/2W 6V DC: 200Ω, 1/2W 12V DC: 510Ω, 1W 24V DC: 1.1 kΩ, 1W
		DPDT	AL2M-M21 ②	AL2M-M21P ②		
	Maintained	SPDT	AL2M-A11 ②	AL2M-A11P ②		
		DPDT	AL2M-A21 ②	AL2M-A21P ②		
	Pilot Light	—	AL2M-P1 ②	AL2M-P1P ②		
	Square AL2Q   (except for pilot lights)	Momentary	SPDT	AL2Q-M11 ②		
DPDT			AL2Q-M21 ②	AL2Q-M21P ②		
Maintained		SPDT	AL2Q-A11 ②	AL2Q-A11P ②		
		DPDT	AL2Q-A21 ②	AL2Q-A21P ②		
Pilot Light		—	AL2Q-P1 ②	AL2Q-P1P ②		
Rectangular AL2H   (except for pilot lights)		Momentary	SPDT	AL2H-M11 ②	AL2H-M11P ②	
	DPDT		AL2H-M21 ②	AL2H-M21P ②		
	Maintained	SPDT	AL2H-A11 ②	AL2H-A11P ②		
		DPDT	AL2H-A21 ②	AL2H-A21P ②		
	Pilot Light	—	AL2H-P1 ②	AL2H-P1P ②		

- LED lamps do not have a current-limiting resistor. Connect a current-limiting resistor in series, otherwise LED lamps will be damaged.
- External current-limiting resistor is not necessary when an optional socket with built-in resistor is used (see page 25).
- AP2M series pilot lights (round bezel only) with built-in current-limiting resistors are also available.
- Pilot lights are not CCC certified.

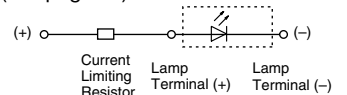

Dimensions

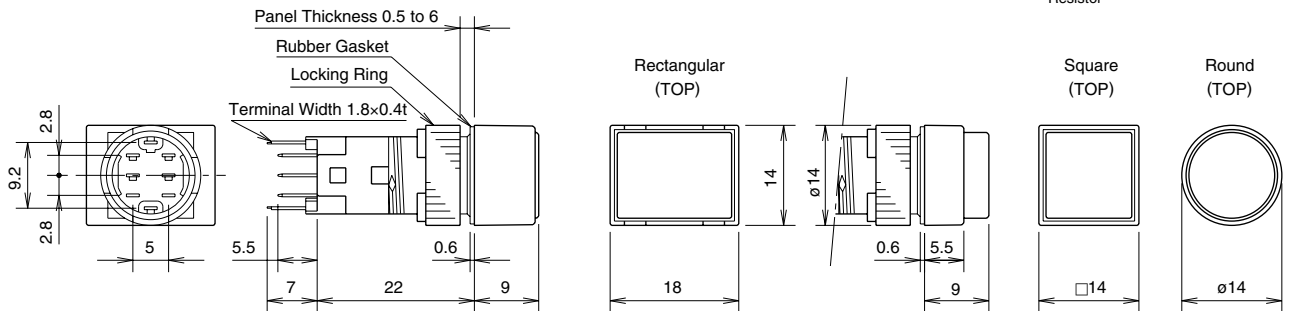

Terminal Arrangement

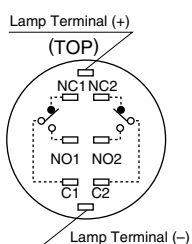

SPDT has NC1, NO1, and C1 only.

Mounting Hole Layout

Round/Square Units

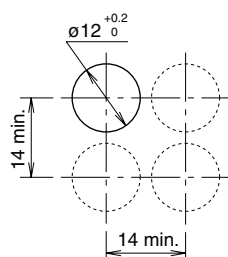

Rectangular Units

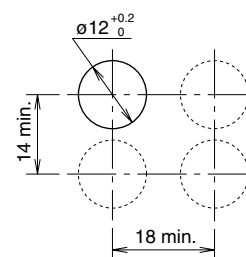







Note: Determine mounting centers to ensure easy operation.

All dimensions in mm.

ø12 A2 Series Pushbuttons

Pushbuttons

Package Quantity: 1

Shape	Button Style	Operation	Contact	Part No.		Color Code ①②	
				IP40	IP65		
Round AB2M  	Button	Momentary	SPDT	AB2M-M1 ①	AB2M-M1P ①	B: black G: green R: red S: blue W: white Y: yellow	
			DPDT	AB2M-M2 ①	AB2M-M2P ①		
		Maintained	SPDT	AB2M-A1 ①	AB2M-A1P ①		
			DPDT	AB2M-A2 ①	AB2M-A2P ①		
	Lens	Momentary	SPDT	AB2M-M1L ②	AB2M-M1PL ②		A: amber G: green R: red W: white Y: yellow
			DPDT	AB2M-M2L ②	AB2M-M2PL ②		
		Maintained	SPDT	AB2M-A1L ②	AB2M-A1PL ②		
			DPDT	AB2M-A2L ②	AB2M-A2PL ②		
Square AB2Q  	Button	Momentary	SPDT	AB2Q-M1 ①	AB2Q-M1P ①	B: black G: green R: red S: blue W: white Y: yellow	
			DPDT	AB2Q-M2 ①	AB2Q-M2P ①		
		Maintained	SPDT	AB2Q-A1 ①	AB2Q-A1P ①		
			DPDT	AB2Q-A2 ①	AB2Q-A2P ①		
	Lens	Momentary	SPDT	AB2Q-M1L ②	AB2Q-M1PL ②		A: amber G: green R: red W: white Y: yellow
			DPDT	AB2Q-M2L ②	AB2Q-M2PL ②		
		Maintained	SPDT	AB2Q-A1L ②	AB2Q-A1PL ②		
			DPDT	AB2Q-A2L ②	AB2Q-A2PL ②		
Rectangular AB2H  	Button	Momentary	SPDT	AB2H-M1 ①	AB2H-M1P ①	B: black G: green R: red S: blue W: white Y: yellow	
			DPDT	AB2H-M2 ①	AB2H-M2P ①		
		Maintained	SPDT	AB2H-A1 ①	AB2H-A1P ①		
			DPDT	AB2H-A2 ①	AB2H-A2P ①		
	Lens	Momentary	SPDT	AB2H-M1L ②	AB2H-M1PL ②		A: amber G: green R: red W: white Y: yellow
			DPDT	AB2H-M2L ②	AB2H-M2PL ②		
		Maintained	SPDT	AB2H-A1L ②	AB2H-A1PL ②		
			DPDT	AB2H-A2L ②	AB2H-A2PL ②		

• Specify a color code in place of ① or ② in the Part No.

Dimensions

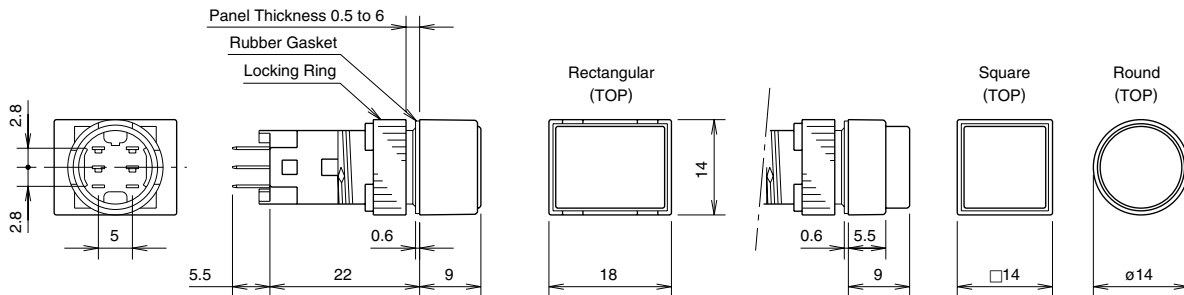

Terminal Arrangement

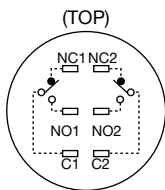

SPDT has NC1, NO1, and C1 only.

Mounting Hole Layout

Round/Square Units

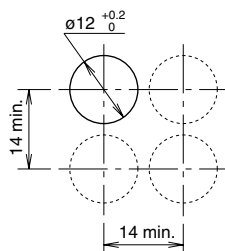

Rectangular Units

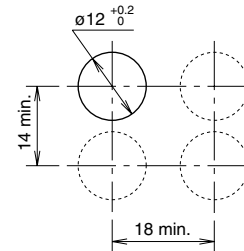

Note: Determine mounting centers to ensure easy operation.

All dimensions in mm.

Accessories						
Shape	Material		Part No.	Ordering Part No.	Package Quantity	Remarks
Locking Ring Wrench 	Metal (nickel-plated brass)		MT-002	MT-002	1	<ul style="list-style-type: none"> Used to tighten the locking ring when installing the A2 series into a panel.
Lens Removal Tool 	Stainless Steel		MT-101	MT-101	1	<ul style="list-style-type: none"> Used to remove lens and button.
Lamp Holder Tool 	Rubber		OR-66	OR-66	1	<ul style="list-style-type: none"> Used to remove and install LED lamps.
Switch Guard 	90° open	For round/square unit	AL-K2	AL-K2	1	<ul style="list-style-type: none"> Degree of protection: IP40 Used to protect pushbuttons from inadvertent operation. See page 26 for dimensions.  (remains 90° open)
		For rectangular unit	AL-KH2	AL-KH2	1	
Socket 	Solder Terminal		AL-C2	AL-C2	1	<ul style="list-style-type: none"> Snaps on the rear of the A2 series. (see page 26 for dimensions)
	PC Board Terminal		AL-C2V	AL-C2V	1	
Socket with Built-in Resistor 	Solder Terminal	5V DC	AL-C21	AL-C21	1	Socket Bottom Color <ul style="list-style-type: none"> Blue Green Yellow Red Blue Green Yellow Red <ul style="list-style-type: none"> A current limiting resistor is contained, eliminating the need for external resistors. When using the socket with a built-in resistor, make sure that the continuous current is 1A maximum and the operating temperature is -25 to +40°C. In collective mounting, keep center-to-center-spacing of 20 mm or more between adjacent units in consideration of built-in resistor heating. See page 26 for dimensions.
		6V DC	AL-C22	AL-C22	1	
		12V DC	AL-C23	AL-C23	1	
		24V DC	AL-C24	AL-C24	1	
	PC Board Terminal	5V DC	AL-C21V	AL-C21V	1	
		6V DC	AL-C22V	AL-C22V	1	
		12V DC	AL-C23V	AL-C23V	1	
		24V DC	AL-C24V	AL-C24V	1	
Terminal Cover 	Nylon		AL-V2	AL-V2PN10	10	<ul style="list-style-type: none"> When wiring the terminals, insert the lead wires into the terminal cover holes before soldering. Terminal cover is not attached and must be ordered separately.
Dust Cover 	For round units		AL-D2	AL-D2	1	<ul style="list-style-type: none"> When mounting the units with the dust covers installed, refer to mounting hole layout on page 26. Operating temperature: -10 to +55°C Material Front part: Elastomer (transparent) Rear part: Polypropylene (black) See page 26 for dimensions and mounting hole layout.
	For square units		AL-DQ2	AL-DQ2	1	
	For rectangular units		AL-DH2	AL-DH2	1	
Mounting Hole Plug 	Nitril rubber (black)		AL-B2	AL-B2PN05	5	<ul style="list-style-type: none"> Degree of protection: IP65

ø12 A2 Series Accessories

Dimensions

Switch Guard

For Round/Square Units (AL-K2)

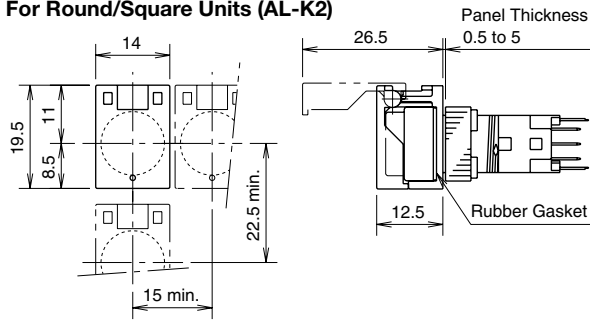

For Rectangular Units (AL-KH2)

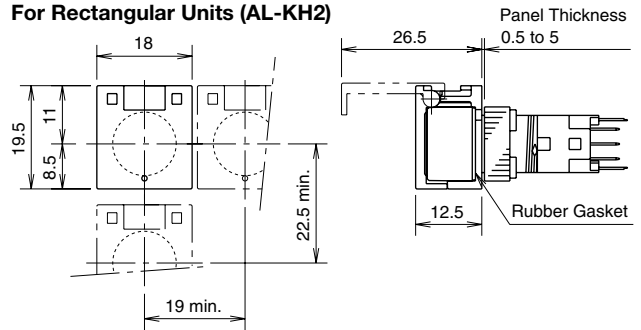

Socket (AL-C2, AL-C2V, AL-C2□)

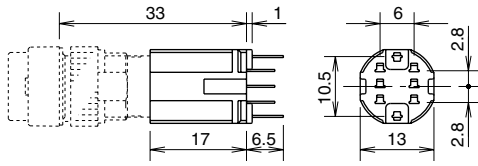

Solder Terminal (AL-C2)

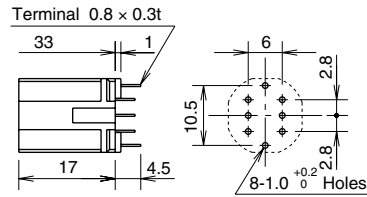

PC Board Terminal (AL-C2V)

Panel Cut-out Bottom View

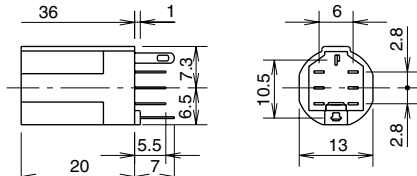
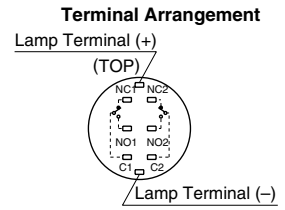

Solder Terminal with Built-in Resistor (AL-C2□)

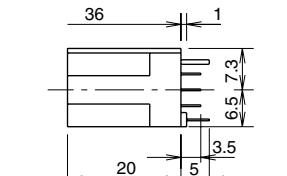

PC Board Terminal with Built-in Resistor (AL-C2□V)

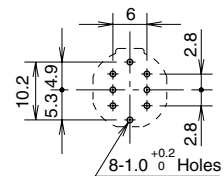

Panel Cut-out Bottom View

Terminal Cover (AL-V2)

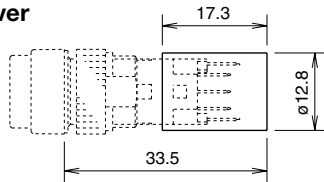

Note: When wiring the terminals, insert the lead wires into the terminal cover holes before soldering.

Dust Cover

For Round Units (AL-D2)

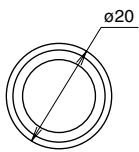

For Square Units (AL-DQ2)

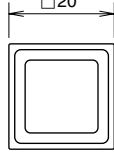

For Rectangular Units (AL-DH2)

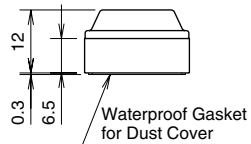
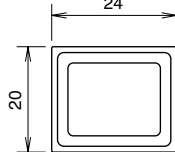

Waterproof Gasket for Dust Cover

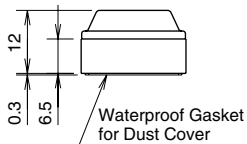

Waterproof Gasket for Dust Cover

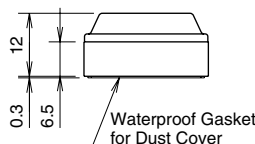

Waterproof Gasket for Dust Cover

Mounting Hole Centers (Round Units, Square Units)

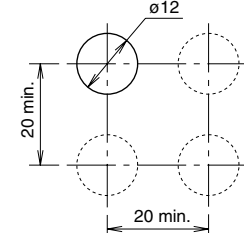

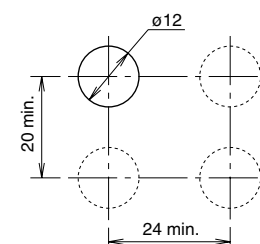

(Rectangular Units)



Note: Determine mounting centers to ensure easy operation.

All dimensions in mm.

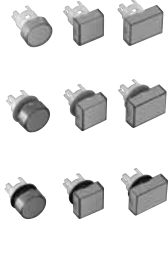
Maintenance Parts

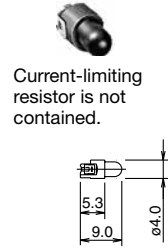
Shape	Specification	Part No.	Ordering Part No.	Package Quantity	Color Code ①②		
Marking Plate 	Round	AL2M-W	AL2M-WPN05	5	White		
	Square	AL2Q-W	AL2Q-WPN05				
	Rectangular	AL2H-W	AL2H-WPN05				
Lens Unit 	For IP40 units	Round	AL2M-LK1-②	AL2M-LK1-②PN02	2	<ul style="list-style-type: none"> • Specify a color code in place of ② in the Part No. A: amber G: green R: red W: white Y: yellow 	
		Square	AL2Q-LK1-②	AL2Q-LK1-②PN02			
		Rectangular	AL2H-LK1-②	AL2H-LK1-②PN02			
	For IP65 illuminated pushbuttons	Round	AL2M-LK2-②	AL2M-LK2-②	1		
		Square	AL2Q-LK2-②	AL2Q-LK2-②			
		Rectangular	AL2H-LK2-②	AL2H-LK2-②			
	For IP65 pilot lights	Round	AL2M-LK3-②	AL2M-LK3-②	1		
		Square	AL2Q-LK3-②	AL2Q-LK3-②			
		Rectangular	AL2H-LK3-②	AL2H-LK3-②			
Button Unit 	For IP40 pushbuttons	Round	AB2M-BK1-①	AB2M-BK1-①PN02	2	<ul style="list-style-type: none"> • Specify a color code in place of ① in the Part No. B: black G: green R: red S: blue W: white Y: yellow 	
		Square	AB2Q-BK1-①	AB2Q-BK1-①PN02			
		Rectangular	AB2H-BK1-①	AB2H-BK1-①PN02			
	For IP65 pushbuttons	Round	AB2M-BK2-①	AB2M-BK2-①	1		
		Square	AB2Q-BK2-①	AB2Q-BK2-①			
		Rectangular	AB2H-BK2-①	AB2H-BK2-①			
LED Lamp  <p style="font-size: small;">Current-limiting resistor is not contained.</p> <p style="font-size: x-small;">All dimensions in mm.</p>	Illumination color: amber	LAD-SA	LAD-SA	1	Lens color	Amber	LED color: amber clear
			LAD-SAPN10	10			
	Illumination color: green	LAD-SG	LAD-SG	1		Green	LED color: yellow diffused
			LAD-SGPN10	10			
	Illumination color: red	LAD-SR	LAD-SR	1		Red	LED color: clear red
			LAD-SRPN10	10			
	Illumination color: yellow	LAD-SY	LAD-SY	1		White/ Yellow	LED color: yellow clear
			LAD-SYPN10	10			

ø12 A2 Series Operating Instructions

Safety Precautions

- Turn off the power to A series before starting installation, removal, wiring, maintenance, and inspection of the units. Failure to turn power off may cause electrical shocks or fire hazard.
- To avoid burning your hand, use the lamp holder tool when replacing lamps.
- For wiring, use wires of a proper gauge to meet the voltage and

current requirements. Failure to tighten terminal screws may cause overheating and create a fire hazard.

Operating Instructions

Replacement of Lens and Marking Plate

Removal

Remove the lens assembly (color lens, marking plate, lens holder, and spring) by holding the color lens recesses with the Lens Removal Tool (MT-101) and pulling it out. Remove the marking plate by disengaging the latches between the color lens and lens holder.

The marking plate must be engraved on the front side as shown below.

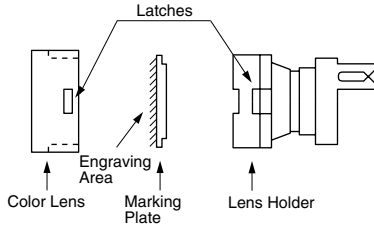

Installation

Place the marking plate on the lens holder in the correct direction, and press the color lens onto the lens holder to engage the latches.

Put the spring on the lens holder and insert the lens holder into the housing in the correct direction.

Installing Non-illuminated Button

Non-illuminated pushbuttons contain a marking plate like illuminated units. Be sure to install the marking plate when replacing the button.

Marking

For A series illuminated pushbuttons, legends and symbols can be engraved on the built-in marking plates, or printed film can be inserted under the lens.

Marking Plate & Engraving Area

Lens	Round	Square	Rectangular
Built-in Marking Plate			
	<ul style="list-style-type: none"> • Engraving must be made on the engraving area less than 0.5mm deep. • The marking plate is made of white acrylic resin. 		

Replacing the LED Lamp

Removal

Use the lamp holder tool (OR-66) to remove lamps. Do not use pliers.

Installation

Use the lamp holder tool (OR-66) to install lamps. Note the correct side of the tool for removal or installation.

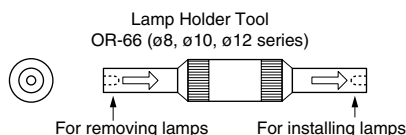

Panel Mounting

When mounting the units onto a panel, use the optional locking ring wrench (MT-002) to tighten the locking ring. Do not use pliers. Tightening torque must not exceed 0.78 N·m. Excessive tightening will damage the locking ring.

Wiring

Solder the terminal at 350°C within 3 seconds using a 60W soldering iron. Sn-Ag-Cu is recommended when using lead-free solder. When soldering, do not touch the unit with the soldering iron. Also ensure that no tensile force is applied to the terminal. Do not bend the terminal or apply excessive force to the terminal. Use non-corrosive rosin flux.

Installing the Socket

Install the socket on the unit with the TOP markings on the unit and the socket placed in the same direction.

Operating Voltage of LED Lamps

The operating voltage is measured at complete DC. When using a pulsating voltage such as a full-wave rectification voltage, keep peak currents within the forward current If. Peak currents exceeding the If may shorten the LED lamp life.

Other Notes

Close Proximity Mounting

When mounting pilot lights or illuminated pushbuttons collectively or lighting them continuously, heat may cause the ambient temperature to rise above the rated operating temperature. When the mounting panel is not made of metal or when the units are mounted in an enclosed panel, provide for ventilation or lower the operating voltage.

Replacement of Buttons (Illuminated/Non-illuminated)

Do not replace buttons of maintained action units while the button is in the locked position. Replacing the button in the locked position may damage the internal mechanism. Be sure to release the button before replacing.

Operating and Storage Environment

1. Make sure that the operating/storage temperature and humidity are within the ratings.
2. Do not use enclosed units (IP40) in an environment subject to oil, water or dust accumulation. In such an area, use the waterproof/oiltight units (IP65).

Microswitch Contacts

Do not connect NO and NC contacts of the microswitch to different voltages or different power sources to prevent a dead short-circuit.



IP65 Units

IP65 units are evaluated by conventional cutting and cooling oils, and can not be used with some special oils. Contact IDEC for resistance against special oils.

ø10 A1 series Switches and Pilot Lights

Short 22-mm-long body miniature switches and pilot lights with LED illumination face and snap-action switching.

- Bright and clear LED illumination.
- All series have terminals on the same plane.
- UL recognized, CSA certified

Applicable Standards	Mark	File No. or Organization
UL508		UL Recognition File No. E55996
CSA C22.2 No.14		CSA File No. LR 21451
GB14048.5		CCC No.2013010305662162 (except for pilot lights)

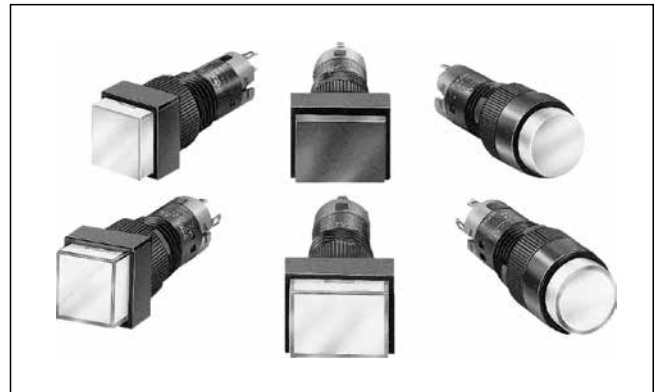

Contact Ratings (Contact Block)

Rated Insulation Voltage	250V			
Rated Thermal Current	3A			
Operating Voltage (AC/DC)	24V	110V	220V	
AC 50/60 Hz	Resistive Load	–	1.0A	0.5A
	Inductive Load	–	0.7A	0.5A
DC	Resistive Load	1.0A	0.2A	–
	Inductive Load	0.7A	0.1A	–
Contact Material	Silver			

- Minimum applicable load: 5V AC/DC, 3 mA
(applicable range may vary with operating conditions and load types)

Weight

Weight (approx.)	AL1M-M11: 3g
	AL1M-P1: 3g
	AB1M-M1: 3g

Specifications

Operating Temperature	–25 to +55°C (no freezing)	
Storage Temperature	–30 to +80°C (no freezing)	
Operating Humidity	45 to 85% RH (no condensation)	
Contact Resistance	50 mΩ maximum (initial value)	
Insulation Resistance	100 MΩ minimum (500V DC megger)	
Dielectric Strength	Switch Unit	Between live and dead metal parts: 2,000V AC, 1 minute Between terminals of different poles: 2,000V AC, 1 minute Between terminals of the same pole: 1,000V AC, 1 minute Between contact and lamp terminals: 1,500V AC, 1 minute
	Illumination Unit	Between live part and ground: 2,000V AC, 1 minute
Vibration Resistance	Damage Limits, Operating extremes: 5 to 55 Hz, amplitude 0.75 mm	
Shock Resistance	Damage limits: 500 m/s ² (50G) Operating extremes: 200 m/s ² (20G)	
Mechanical Durability (minimum operations)	Momentary: 200,000 operations Maintained: 100,000 operations	
Electrical Durability (minimum operations)	Momentary: 100,000 operations Maintained: 50,000 operations (Switching frequency 1200 operations/h)	
Degree of Protection	IP40 (IEC 60529)	

LED Lamp Ratings (LAD-S)

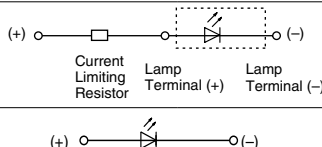
Built-in LED Part No.	LAD-SA	LAD-SG	LAD-SR	LAD-SY
Lamp Base	Exclusive for A series			
Forward Current (If)	20 mA			
Forward Voltage (Vf) (nominal)	2.2V	2.1V	1.7V	2.2V
Reverse Voltage (Vr)	4V			
Illumination Color	A	G	R	Y
LED Lamp Color	Amber Clear	Yellow Diffused	Red Clear	Yellow Clear
Applicable Lens Color	Amber	Green	Red	Yellow and White
Base Plastic Color	Red			
LED Lamp Life (reference value)	Approx. 50,000 hours (The illuminance reduces to 50% of the initial intensity when used on complete DC.)			
Operating Voltage & External Current-limiting Resistor (recommended value) (Note)	5V DC: 150Ω, 1/2W 6V DC: 200Ω, 1/2W 12V DC: 510Ω, 1W 24V DC: 1.1 kΩ, 1W			
Internal Circuit				







Note: When LED lamps are used on voltages other than the above, external resistor value R is determined by the following formula:
 $R = (\text{operating voltage} - V_f) / I_f$

- LED lamps do not have a current-limiting resistor, and external resistors of recommended values for each voltage must be provided. Connect a current-limiting resistor in series, otherwise LED lamps will be damaged. Because no protection diode is contained, ensure the correct polarity is observed.

ø10 A1 Series Illuminated Pushbuttons and Pilot Lights

Illuminated Pushbuttons & Pilot Lights

Package Quantity: 1

Shape	Operation	Contact	Part No.	② Lens Color Code	LED Lamp
			IP40		Part No., Rated Current (External Resistor Recommended Value)
Round AL1M   (except for pilot lights)	Momentary	SPDT	AL1M-M11②	Specify a color code in place of ② in the Part No. A: amber G: green R: red W: white Y: yellow	A: LAD-SA G: LAD-SG R: LAD-SR W/Y: LAD-SY Rated Current: 20 mA 5V DC: 150Ω, 1/2W 6V DC: 200Ω, 1/2W 12V DC: 510Ω, 1W 24V DC: 1.1 kΩ, 1W
	Maintained	SPDT	AL1M-A11②		
	Pilot Light	—	AL1M-P1②		
Square AL1Q   (except for pilot lights)	Momentary	SPDT	AL1Q-M11②		
	Maintained	SPDT	AL1Q-A11②		
	Pilot Light	—	AL1Q-P1②		
Rectangular AL1H   (except for pilot lights)	Momentary	SPDT	AL1H-M11②		
	Maintained	SPDT	AL1H-A11②		
	Pilot Light	—	AL1H-P1②		

- LED lamps do not have a current-limiting resistor. Connect a current-limiting resistor in series, otherwise LED lamps will be damaged.
- AP1M series pilot lights (round bezel only) with built-in current-limiting resistor are also available.
- Pilot lights are not CCC certified.



Dimensions

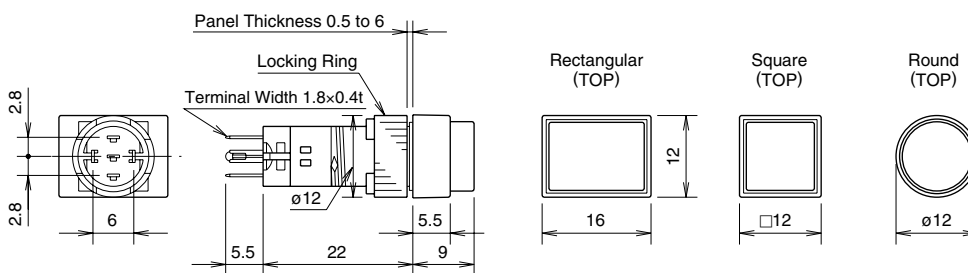

Terminal Arrangement (bottom view)

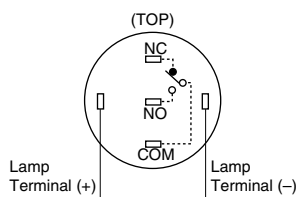

Mounting Hole Layout

Round/Square Units

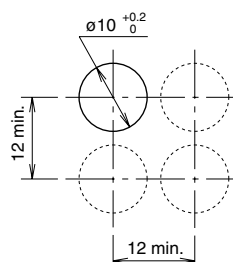



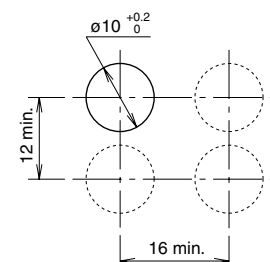



Rectangular Units



Note: Determine mounting centers to ensure easy operation.

All dimensions in mm.

Pushbuttons					
					Package Quantity: 1
Shape	Button Style	Operation	Contact	Part No.	Color Code ①②
				IP40	
Round AB1M  	Button	Momentary	SPDT	AB1M-M1 ①	B black G: green R: red S: blue W: white Y: yellow A: amber G: green R: red W: white Y: yellow
		Maintained	SPDT	AB1M-A1 ①	
	Lens	Momentary	SPDT	AB1M-M1L ②	
		Maintained	SPDT	AB1M-A1L ②	
Square AB1Q  	Button	Momentary	SPDT	AB1Q-M1 ①	
		Maintained	SPDT	AB1Q-A1 ①	
	Lens	Momentary	SPDT	AB1Q-M1L ②	
		Maintained	SPDT	AB1Q-A1L ②	
Rectangular AB1H  	Button	Momentary	SPDT	AB1H-M1 ①	
		Maintained	SPDT	AB1H-A1 ①	
	Lens	Momentary	SPDT	AB1H-M1L ②	
		Maintained	SPDT	AB1H-A1L ②	

• Specify a color code in place of ① or ② in the Part No.

Dimensions

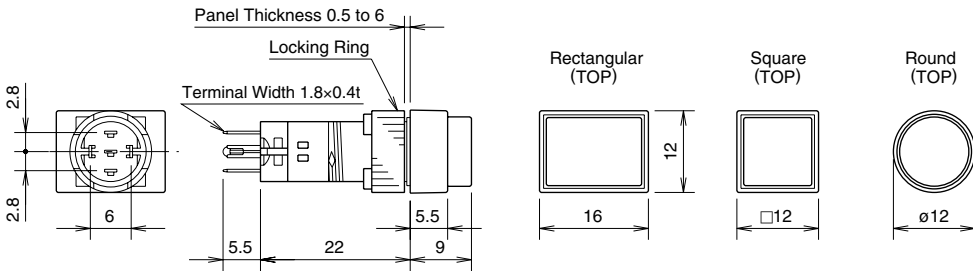

Terminal Arrangement (bottom view)

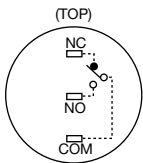

Mounting Hole Layout

Round/Square Units

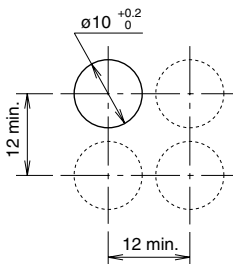

Rectangular Units

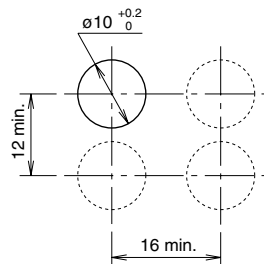





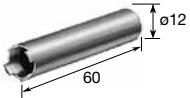
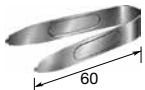

Note: Determine mounting centers to ensure easy operation.

All dimensions in mm.

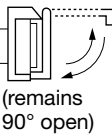
ø10 A1 Series Accessories

Accessories

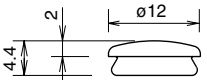
Shape	Material	Part No.	Ordering No.	Package Quantity	Remarks	
Locking Ring Wrench 	Metal (nickel-plated brass)	MT-003	MT-003	1	<ul style="list-style-type: none"> Used to tighten the locking ring when installing the A1 series into a panel. 	
Lens Removal Tool 	Stainless Steel	MT-101	MT-101	1	<ul style="list-style-type: none"> Used to remove lens and button. 	
Lamp Holder Tool 	Rubber	OR-66	OR-66	1	<ul style="list-style-type: none"> Used to remove and install LED lamps. 	
Switch Guard 	90° open	For round/ square unit	AL-K1	AL-K1	1	<ul style="list-style-type: none"> Used to protect pushbuttons from inadvertent operation. See page 33 for dimensions.  (remains 90° open)
		For rectangular unit	AL-KH1	AL-KH1	1	
Socket 	Solder Terminal	AL-C1	AL-C1	1	<ul style="list-style-type: none"> Snaps on the rear of the A1 series. (see page 33 for dimensions) 	
	PC Board Terminal	AL-C1V	AL-C1V	1		
Terminal Cover 	Nylon	AL-V1	AL-V1PN10	10	<ul style="list-style-type: none"> When wiring the terminals, insert the lead wires into the terminal cover holes before soldering. Terminal cover is not attached and must be ordered separately. 	
Mounting Hole Plug 	Nitryl rubber (black)	AL-B1	AL-B1PN05	5	<ul style="list-style-type: none"> Degree of protection: IP65 	

Dimensions

Switch Guard

For Round/Square Units (AL-K1)

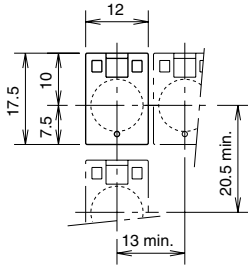

For Rectangular Units (AL-KH1)

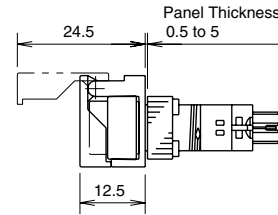
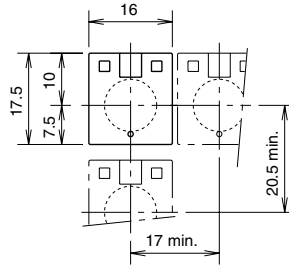

Socket (AL-C1, AL-C1V)

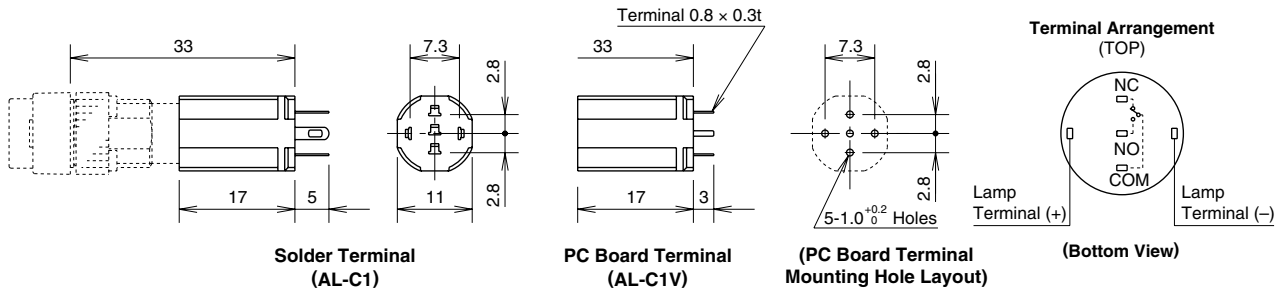



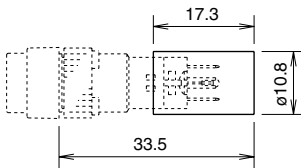

Terminal Cover



Note: When wiring the terminals, insert the lead wires into the terminal cover holes before soldering.

All dimensions in mm.

Maintenance Parts

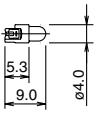
Shape		Part No.	Ordering No.	Package Quantity	Color Code ①②		
Marking Plate 	Round	AL1M-W	AL1M-WPN05	5	• White		
	Square	AL1Q-W	AL1Q-WPN05				
	Rectangular	AL1H-W	AL1H-WPN05				
Lens Unit 	Round	AL1M-LK1-②	AL1M-LK1-②PN02	2	Specify a color code in place of ② in the Part No. A (amber), G (green), R (red) W (white), Y (yellow)		
	Square	AL1Q-LK1-②	AL1Q-LK1-②PN02				
	Rectangular	AL1H-LK1-②	AL1H-LK1-②PN02				
Button Unit 	Round	AB1M-BK1-①	AB1M-BK1-①PN02	2	Specify a color code in place of ① in the Part No. B (black), G (green), R (red) S (blue), W (white), Y (yellow)		
	Square	AB1Q-BK1-①	AB1Q-BK1-①PN02				
	Rectangular	AB1H-BK1-①	AB1H-BK1-①PN02				
LED Lamp  Current-limiting resistor is not contained.  All dimensions in mm.	Illumination color: amber	LAD-SA	LAD-SA	1	Lens color	Amber	LED color: amber clear
			LAD-SAPN10	10		Green	LED color: yellow diffused
	Illumination color: green	LAD-SG	LAD-SG	1		Red	LED color: clear red
			LAD-SGPN10	10		White/Yellow	LED color: yellow clear
	Illumination color: red	LAD-SR	LAD-SR	1			
			LAD-SRPN10	10			
	Illumination color: yellow	LAD-SY	LAD-SY	1			
			LAD-SYPN10	10			

Safety Precautions

- Turn off the power to A series before starting installation, removal, wiring, maintenance, and inspection of the units. Failure to turn power off may cause electrical shocks or fire hazard.
- To avoid burning your hand, use the lamp holder tool when replacing lamps.
- For wiring, use wires of a proper gauge to meet the voltage and

current requirements. Failure to tighten terminal screws may cause overheating and create a fire hazard.

Operating Instructions

Replacement of Lens and Marking Plate

Removal

Remove the lens assembly (color lens, marking plate, lens holder, and spring) by holding the color lens recesses with the Lens Removal Tool (MT-101) and pulling it out. Remove the marking plate by disengaging the latches between the color lens and lens holder.

The marking plate must be engraved on the front side as shown below.

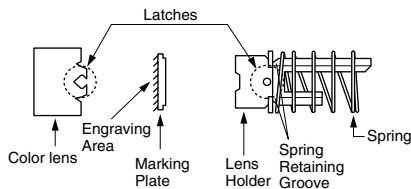

Note: Make sure that the spring is inserted in the correct direction. The base of spring must fit the groove in the holder.

Installation

Place the marking plate on the lens holder in the correct direction, and press the color lens onto the lens holder to engage the latches.

Put the spring on the lens holder and insert the lens holder into the housing in the correct direction.

Installing Non-illuminated Button

Non-illuminated pushbuttons contain a marking plate like illuminated units. Be sure to install the marking plate when replacing the button.

Marking

For A series illuminated pushbuttons, legends and symbols can be engraved on the built-in marking plates, or printed film can be inserted under the lens.

Marking Plate & Engraving Area

Lens	Round	Square	Rectangular
Built-in Marking Plate			
	<ul style="list-style-type: none"> • Engraving must be made on the engraving area less than 0.5mm deep. • The marking plate is made of white acrylic resin. 		

Replacing the LED Lamp

Removal

Use the lamp holder tool (OR-66) to remove lamps. Do not use pliers.

Installation

Use the lamp holder tool (OR-66) to install lamps. Note the correct side of the tool for removal or installation.

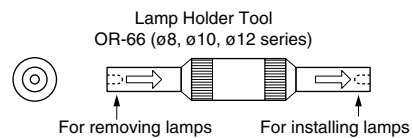

Panel Mounting

When mounting the units into a panel, use the optional locking ring wrench (MT-003) to tighten the locking ring. Do not use pliers. Tightening torque must not exceed 0.29 N·m. Excessive tightening will damage the locking ring.

Wiring

Solder the terminal at 350°C within 3 seconds using a 60W soldering iron. Sn-Ag-Cu is recommended when using lead-free solder. When soldering, do not touch the unit with the soldering iron. Also ensure that no tensile force is applied to the terminal. Do not bend the terminal or apply excessive force to the terminal. Use non-corrosive rosin flux.

Installing the Socket

Install the socket on the unit with the TOP markings on the unit and the socket placed in the same direction.

Operating Voltage of LED Lamps

The operating voltage is measured at complete DC. When using a pulsating voltage such as a full-wave rectification voltage, keep peak currents within the forward current If. Peak currents exceeding the If may shorten the LED lamp life.

Other Notes

Close Proximity Mounting

When mounting pilot lights or illuminated pushbuttons collectively or lighting them continuously, heat may cause the ambient temperature to rise above the rated operating temperature. When the mounting panel is not made of metal or when the units are mounted in an enclosed panel, provide for ventilation or lower the operating voltage.

Replacement of Buttons (Illuminated/Non-illuminated)

Do not replace buttons of maintained action units while the button is in the locked position. Replacing the button in the locked position may damage the internal mechanism. Be sure to release the button before replacing.

Operating and Storage Environment

1. Make sure that the operating/storage temperature and humidity are within the ratings.
2. Do not use enclosed type units in an environment subject to oil, water or dust accumulation.

Microswitch Contacts



Do not connect NO and NC contacts of the microswitch to different voltages or different power sources to prevent a dead short-circuit.

ø8

A8 series Switches and Pilot Lights

Short 22-mm-long body miniature switches and pilot lights with LED illumination face and snap-action switching.

- Bright and clear LED illumination.
- All series have terminals on the same plane.
- UL recognized, CSA certified

Applicable Standards	Mark	File No. / Organization
UL508		UL Recognition File No. E55996
CSA C22.2 No.14		CSA File No. LR 21451
GB14048.5		CCC No.2013010305650376 (except for pilot lights)



Contact Ratings (Contact Block)

Rated Insulation Voltage	250V			
Rated Thermal Current	3A			
Operating Voltage (AC/DC)	24V	110V	220V	
AC 50/60 Hz	Resistive Load	–	1.0A	0.5A
	Inductive Load	–	0.7A	0.5A
DC	Resistive Load	1.0A	0.2A	–
	Inductive Load	0.7A	0.1A	–
Contact Material	Silver			

- Minimum applicable load: 5V AC/DC, 3 mA
(applicable range may vary with operating conditions and load types)



Weight

Weight (approx.)	AL8M-M11: 2g
	AL8M-P1: 2g
	AB8M-M1: 2g

Specifications

Operating Temperature	–25 to +55°C (no freezing)	
Storage Temperature	–30 to +80°C (no freezing)	
Operating Humidity	45 to 85% RH (no condensation)	
Contact Resistance	50 mΩ maximum (initial value)	
Insulation Resistance	100 MΩ minimum (500V DC megger)	
Dielectric Strength	Switch Unit	Between live and dead metal parts 2,000V AC, 1 minute Between terminals of different poles: 2,000V AC, 1 minute Between terminals of the same pole: 1,000V AC, 1 minute Between contact and lamp terminals: 1,500V AC, 1 minute
	Illumination Unit	Between live part and ground: 2,000V AC, 1 minute
Vibration Resistance	Damage Limits, Operating extremes: 5 to 55 Hz, amplitude 0.75 mm	
Shock Resistance	Damage limits: 500 m/s ² (50G) Operating extremes: 200 m/s ² (20G)	
Mechanical Durability (minimum operations)	Momentary: 200,000 operations Maintained: 100,000 operations	
Electrical Durability (minimum operations)	Momentary: 100,000 operations Maintained: 50,000 operations (Switching frequency 1200 operations/h)	
Degree of Protection	IP40 (IEC 60529)	

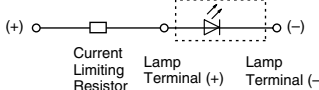
LED Lamp Ratings (LAD-S)

Part No.	LAD-SA	LAD-SG	LAD-SR	LAD-SY
Lamp Base	Exclusive for A series			
Forward Current (If)	20 mA			
Forward Voltage (Vf) (nominal)	2.2V	2.1V	1.7V	2.2V
Reverse Voltage (Vr)	4V			
Illumination Color	A	G	R	Y
LED Lamp Color	Amber Clear	Yellow Diffused	Red Clear	Yellow Clear
Applicable Lens Color	Amber	Green	Red	Yellow and White
Base Plastic Color	Red			
LED Lamp Life (reference value)	Approx. 50,000 hours (The illuminance reduces to 50% of the initial intensity when used on complete DC.)			
Operating Voltage & External Current-limiting Resistor (recommended value) (Note)	5V DC: 150Ω, 1/2W 6V DC: 200Ω, 1/2W 12V DC: 510Ω, 1W 24V DC: 1.1 kΩ, 1W			
Internal Circuit				







Note: When LED lamps are used on voltages other than the above, external resistor value R is determined by the following formula:
 $R = (\text{operating voltage} - V_f) / I_f$

- LED lamps do not have a current-limiting resistor, and external resistors of recommended values or each voltage must be provided. Connect a current-limiting resistor in series, otherwise LED lamps will be damaged. Because no protection diode is contained, ensure the correct polarity is observed.

ø8 A8 Series Illuminated Pushbuttons and Pilot Lights

Illuminated Pushbuttons & Pilot Lights

Package Quantity: 1

Shape	Operation	Contact	Part No.	② Lens Color Code	LED Lamp
			IP40		Part No., Rated Current (External Resistor Recommended Value)
Round AL8M   (except for pilot lights)	Momentary	SPDT	AL8M-M11②	Specify a color code in place of ② in the Part No. A: amber G: green R: red W: white Y: yellow	A: LAD-SA G: LAD-SG R: LAD-SR W/Y: LAD-SY Rated Current: 20 mA 5V DC: 150Ω, 1/2W 6V DC: 200Ω, 1/2W 12V DC: 510Ω, 1W 24V DC: 1.1 kΩ, 1W
	Maintained	SPDT	AL8M-A11②		
	Pilot Light	—	AL8M-P1②		
Square AL8Q   (except for pilot lights)	Momentary	SPDT	AL8Q-M11②		
	Maintained	SPDT	AL8Q-A11②		
	Pilot Light	—	AL8Q-P1②		
Rectangular AL8H   (except for pilot lights)	Momentary	SPDT	AL8H-M11②		
	Maintained	SPDT	AL8H-A11②		
	Pilot Light	—	AL8H-P1②		

- LED lamps do not have a current-limiting resistor. Connect a current-limiting resistor in series, otherwise LED lamps will be damaged.
- AP8M series pilot lights (round bezel only) with built-in current-limiting resistor are also available.
- Pilot lights are not CCC certified.



Dimensions

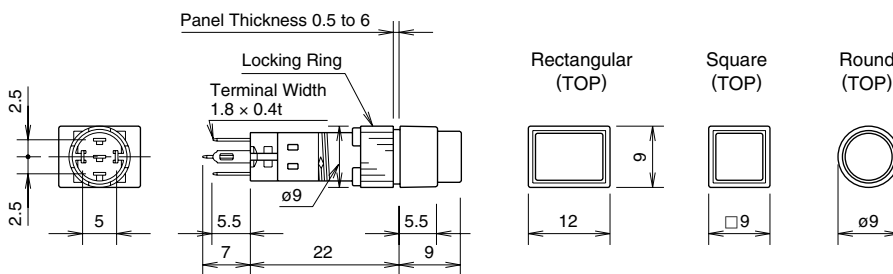

Terminal Arrangement

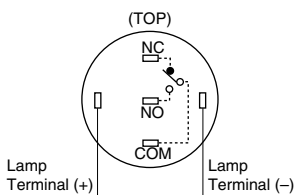

Mounting Hole Layout

Round/Square Units

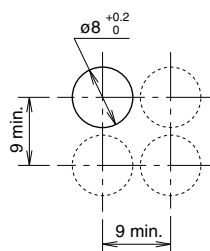

Rectangular Units

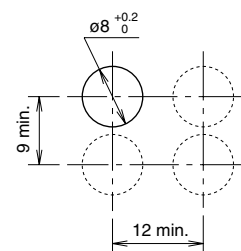







Note: Determine mounting centers to ensure easy operation.

All dimensions in mm.

Pushbuttons

Package Quantity: 1

Shape	Button Style	Operation	Contact	Part No.	Color Code ①②
				IP40	
Round AB8M  	Button	Momentary	SPDT	AB8M-M1 ①	B: black G: green R: red S: blue W: white Y: yellow
		Maintained	SPDT	AB8M-A1 ①	
	Lens	Momentary	SPDT	AB8M-M1L ②	A: amber G: green R: red W: white Y: yellow
		Maintained	SPDT	AB8M-A1L ②	
Square AB8Q  	Button	Momentary	SPDT	AB8Q-M1 ①	B: black G: green R: red S: blue W: white Y: yellow
		Maintained	SPDT	AB8Q-A1 ①	
	Lens	Momentary	SPDT	AB8Q-M1L ②	A: amber G: green R: red W: white Y: yellow
		Maintained	SPDT	AB8Q-A1L ②	
Rectangular AB8H  	Button	Momentary	SPDT	AB8H-M1 ①	B: black G: green R: red S: blue W: white Y: yellow
		Maintained	SPDT	AB8H-A1 ①	
	Lens	Momentary	SPDT	AB8H-M1L ②	A: amber G: green R: red W: white Y: yellow
		Maintained	SPDT	AB8H-A1L ②	

- Specify a color code in place of ① or ② in the Part No.
- Lens style buttons can be used with marking plate and film.

Dimensions

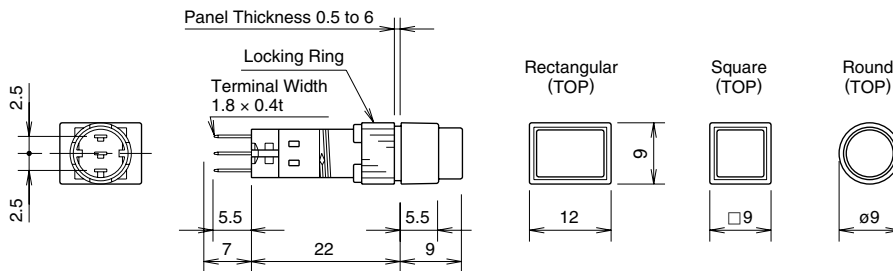

Terminal Arrangement (bottom view)

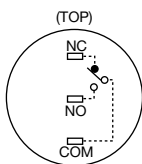

Mounting Hole Layout

Round/Square Units

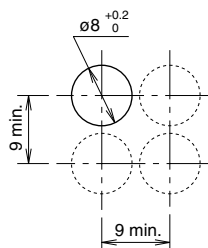



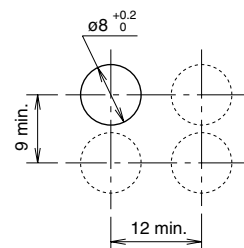



Rectangular Units

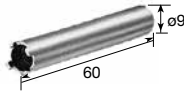
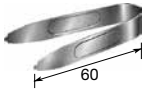

Note: Determine mounting centers to ensure easy operation.

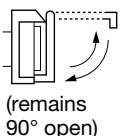
All dimensions in mm.

Accessories

Shape	Material	Part No.	Ordering Part No.	Package Quantity	Remarks
	Metal (nickel-plated brass)	MT-004	MT-004	1	<ul style="list-style-type: none"> Used to tighten the locking ring when installing the A8 series into a panel.
	Stainless Steel	MT-101	MT-101	1	<ul style="list-style-type: none"> Used to remove the lens and button.
	Rubber	OR-66	OR-66	1	<ul style="list-style-type: none"> Used to remove and install the LED lamps.
	90° open	For round/ square Unit AL-K8	AL-K8	1	<ul style="list-style-type: none"> Used to protect pushbuttons from inadvertent operation. See page 38 for dimensions.  (remains 90° open)
		For rectangular unit AL-KH8	AL-KH8	1	
	Solder Terminal	AL-C8	AL-C8	1	<ul style="list-style-type: none"> Snaps on the rear of the A8 series. (see page 38 for dimensions)
	PC Board Terminal	AL-C8V	AL-C8V	1	
	Nylon	AL-V8	AL-V8PN10	10	<ul style="list-style-type: none"> When wiring the terminals, insert the lead wires into the terminal cover holes before soldering. Terminal cover is not attached and must be ordered separately.
	Nitril rubber (black)	AL-B8	AL-B8PN05	5	<ul style="list-style-type: none"> Degree of protection: IP65

Dimensions

Switch Guard

For Round/Square Units (AL-K8)

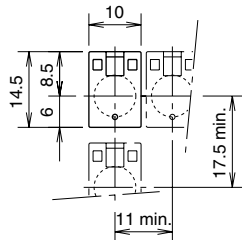

For Rectangular Units (AL-KH8)

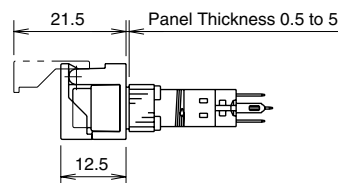
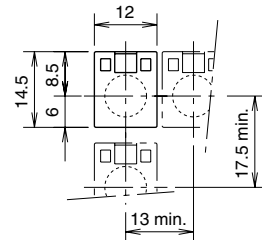

Socket (AL-C8, AL-C8V)

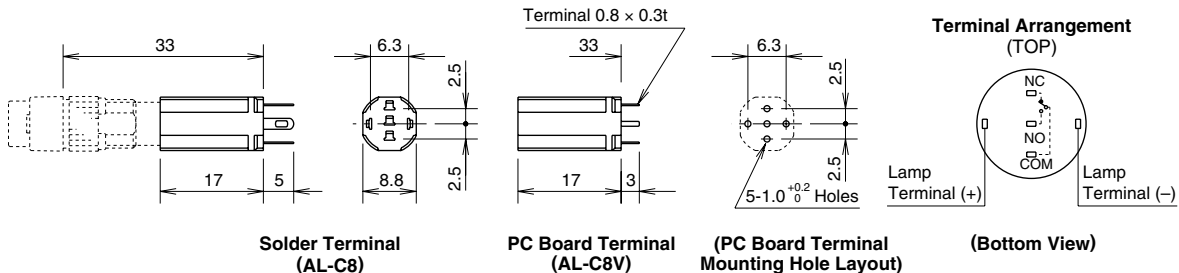

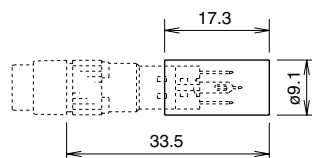

Terminal Cover (AL-V8)



Note: When wiring the terminals, insert the lead wires into the terminal cover holes before soldering.

All dimensions in mm.

Maintenance Parts

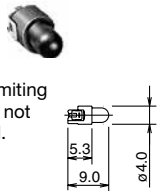
Shape		Part No.	Ordering Part No.	Package Quantity	Color Code ①②		
Marking Plate 	Round	AL8M-W	AL8M-WPN05	5	• White		
	Square	AL8Q-W	AL8Q-WPN05				
	Rectangular	AL8H-W	AL8H-WPN05				
Lens Unit 	Round	AL8M-LK1-②	AL8M-LK1-②PN02	2	Specify a color code in place of ② in the Part No. A (amber), G (green), R (red) W (white), Y (yellow)		
	Square	AL8Q-LK1-②	AL8Q-LK1-②PN02				
	Rectangular	AL8H-LK1-②	AL8H-LK1-②PN02				
Button Unit 	Round	AB8M-BK1-①	AB8M-BK1-①PN02	2	Specify a color code in place of ① in the Part No. B (black), G (green), R (red) S (blue), W (white), Y (yellow)		
	Square	AB8Q-BK1-①	AB8Q-BK1-①PN02				
	Rectangular	AB8H-BK1-①	AB8H-BK1-①PN02				
LED Lamp  <p>Current-limiting resistor is not contained.</p> <p>All dimensions in mm.</p>	Illumination color: amber	LAD-SA	LAD-SA	1	Lens color	Amber	LED color: amber clear
		LAD-SAPN10	LAD-SAPN10	10			
	Illumination color: green	LAD-SG	LAD-SG	1		Green	LED color: yellow diffused
		LAD-SGPN10	LAD-SGPN10	10			
	Illumination color: red	LAD-SR	LAD-SR	1		Red	LED color: clear red
		LAD-SRPN10	LAD-SRPN10	10			
	Illumination color: yellow	LAD-SY	LAD-SY	1		White/ Yellow	LED color: yellow clear
		LAD-SYPN10	LAD-SYPN10	10			

Safety Precautions

- Turn off the power to A series before starting installation, removal, wiring, maintenance, and inspection of the units. Failure to turn power off may cause electrical shocks or fire hazard.
- To avoid burning your hand, use the lamp holder tool when replacing lamps.
- For wiring, use wires of a proper size to meet the voltage and current requirements. Failure to tighten terminal screws may cause overheating and create a fire hazard.

Operating Instructions

Replacement of Lens and Marking Plate

Removal

Remove the operator (color lens, marking plate, lens holder, and spring) by holding the color lens recesses with the Lens Removal Tool (MT-101) and pulling it out. Remove the marking plate by disengaging the latches between the color lens and lens holder. The marking plate must be engraved on the front side as shown below.

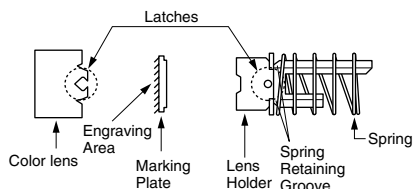

Note: Make sure that the spring is inserted in the correct direction. The base of spring must fit the groove in the holder.

Installation

Place the marking plate on the lens holder in the correct direction, and press the color lens onto the lens holder to engage the latches.
Put the spring on the lens holder and insert the lens holder into the housing in the correct direction.

Installing Non-illuminated Button

Non-illuminated pushbuttons contain a marking plate like illuminated units. Be sure to install the marking plate when replacing the button.

Marking

For A series illuminated pushbuttons, legends and symbols can be engraved on the built-in marking plates, or printed film can be inserted under the lens.

Marking Plate & Engraving Area

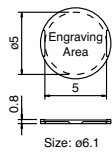
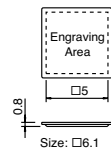
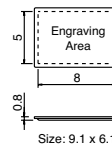
Lens	Round	Square	Rectangular
Built-in Marking Plate			
	<ul style="list-style-type: none"> • Engraving must be made on the engraving area less than 0.5mm deep. • The marking plate is made of white acrylic resin. 		

Operating Instructions

Replacing the LED Lamp

Removal

Use the lamp holder tool (OR-66) to remove lamps. Do not use pliers.

Installation

Use the lamp holder tool (OR-66) to install lamps. Note the correct side of the tool for removal or installation.

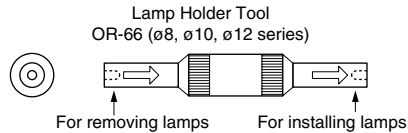

Panel Mounting

When mounting the units onto a panel, use the optional locking ring wrench (MT-004) to tighten the locking ring. Do not use pliers. Tightening torque must not exceed 0.29 N·m. Excessive tightening will damage the locking ring.

Wiring

Solder the terminal at 350°C within 3 seconds using a 60W soldering iron. Sn-Ag-Cu is recommended when using lead-free solder. When soldering, do not touch the enabling switch with the soldering iron. Also ensure that no tensile force is applied to the terminal. Do not bend the terminal or apply excessive force to the terminal.

Use a non-corrosive rosin flux.

Installing the Socket

Install the socket on the unit with the TOP markings on the unit and the socket placed in the same direction.

Operating Voltage of LED Lamps

The operating voltage of 5V DC is measured at complete DC. When using a pulsating voltage such as a full-wave rectification voltage, keep peak currents within the forward current I_f . Peak currents exceeding the I_f may shorten the LED lamp life.

Other Notes

Close Proximity Mounting

When mounting pilot lights or illuminated pushbuttons collectively or lighting them continuously, heat may cause the ambient temperature to rise above the rated operating temperature. When the mounting panel is not made of metal or when the units are mounted in an enclosed panel, provide for ventilation or lower the operating voltage.

Replacement of Buttons (Illuminated/Non-illuminated)

Do not replace buttons of maintained action units while the button is in the locked position. Replacing the button in the locked position may damage the internal mechanism. Be sure to release the button before replacing.

Operating and Storage Environment

1. Make sure that the operating/storage temperature and humidity are within the ratings.
2. Do not use enclosed type units in an environment subject to oil, water or dust accumulation.

Microswitch Contacts

Do not connect NO and NC contacts of the microswitch to different voltages or different power sources to prevent a dead short-circuit.

IDEC CORPORATION

Head Office

6-64, Nishi-Miyahara-2-Chome, Yodogawa-ku, Osaka 532-0004, Japan

 www.idec.com

USA	IDEC Corporation	Tel: +1-408-747-0550	opencontact@idec.com	Hong Kong	IDEC Izumi (H.K.) Co., Ltd.	Tel: +852-2803-8989	info@hk.idec.com
Germany	IDEC Elektrotechnik GmbH	Tel: +49-40-25 30 54 - 0	service@eu.idec.com	China/Shanghai	IDEC (Shanghai) Corporation	Tel: +86-21-6135-1515	idec@cn.idec.com
Singapore	IDEC Izumi Asia Pte. Ltd.	Tel: +65-6746-1155	info@sg.idec.com	China/Shenzhen	IDEC (Shenzhen) Corporation	Tel: +86-755-8356-2977	idec@cn.idec.com
Thailand	IDEC Asia (Thailand) Co., Ltd.	Tel: +66-2-392-9765	sales@th.idec.com	China/Beijing	IDEC (Beijing) Corporation	Tel: +86-10-6581-6131	idec@cn.idec.com
Australia	IDEC Australia Pty. Ltd.	Tel: +61-3-8523-5900	sales@au.idec.com	Japan	IDEC Corporation	Tel: +81-6-6398-2527	marketing@idec.co.jp
Taiwan	IDEC Taiwan Corporation	Tel: +886-2-2698-3929	service@tw.idec.com				

Specifications and other descriptions in this brochure are subject to change without notice.
2017 IDEC Corporation, All Rights Reserved.