



ENCLOSURES & CABLE GLANDS

Since 1996

INDUSTRIAL AUTOMATION

BOXCO®
CONTENTS



INDUSTRIAL AUTOMATION



BOXCO INTRODUCTION

박스코 소개 / 公司简介

03	Greetings	인사말	致词
04	History	연혁	历史
05	Certification	인증현황	认证现状
06	UL508A Certification list	UL508A 인증리스트	获得UL508A认证的产品
07	IP · IK Ratings	IP · IK 보호등급	IP·IK 保护等级
08	Customize	주문제작	定制

01 PLASTIC BOX

플라스틱 박스 / 塑料盒

Hinge type / 힌지 타입 / 铰链型

11	Q Series	Q 시리즈	Q 系列
13	R Series	R 시리즈	R 系列
15	P Series	P 시리즈	P 系列
18	D Series	일체형 이중도어	一体型双层门
19	UH Series	UH 시리즈	UH 系列
20	H Series	H 시리즈	H 系列
40	SMPS Case	SMPS 박스	SMPS 盒
40	CONCENT Case	CONCENT 박스	CONCENT 盒

Screw type / 스크류 타입 / 螺栓型

25	M Series	M 시리즈	M 系列
27	U Series	U 시리즈	U 系列
28	S Series	S 시리즈	S 系列
31	Knock-Out Box	녹아웃 박스	敲落孔盒
32	Push Button Box	푸시버튼 박스	按钮盒
34	Terminal Block Box	단자박스	端子盒
40	BC-AB-111108	BC-AB-111108	BC-AB-111108

02 ALUMINUM BOX

알루미늄 박스 / 铸铝盒

43	Aluminum ALS Series	알루미늄 ALS 시리즈	铸铝ALS系列
44	Aluminum AL Series	알루미늄 AL 시리즈	铸铝AL系列
45	Aluminum Push Button Box	알루미늄 푸시버튼 박스	铸铝按钮盒
46	Aluminum Terminal Block Box	알루미늄 단자박스	铸铝端子盒

03 CABLE GLANDS, PLUGS & ACCESSORIES

케이블 그랜드, 플러그 및 액세서리 / 电缆防护接头, 闷盖 & 配件

53	Dual door	이중도어	双层门
54	Cable glands, Plugs - PG Series	케이블 그랜드, 플러그 - PG 시리즈	电缆防水接头, 插头 - PG 系列
59	Cable glands, Plugs - M Series	케이블 그랜드, 플러그 - M 시리즈	电缆防水接头, 插头 - M 系列
63	Accessories	액세서리	配件
65	Conta clip	콘타클립	Conta clip

Greetings 인사말 / 致词

— BOXCO gives you greater value in quality.

BOXCO is a specialized company in manufacturing enclosures and cases for protecting electrical, electronic and control instruments.

We offer high quality of products and services promptly around the world through facilities for mass production and efficient supply system, and supply economic customized products to meet customer's requirement as well as standard products.

We will supply high quality of products with competitive price by pursuing continuous investments and constant changes.

BOXCO believes in a personal commitment to quality.

Our number one priority is customer satisfaction and we do so through producing the highest quality product with competitive price in the industry.

Thank you.

— 박스코는 품질로써 더 큰 가치를 드립니다.

전기·전자용 제어기기와 시스템 보호용 박스 및 케이스를 전문적으로 생산하고 있는 박스코는 대량 생산설비와 효율적인 공급체계를 통해 전 세계의 모든 고객이 만족할 수 있는 고품질의 제품과 서비스를 신속하게 제공하고 있습니다.

표준제품뿐만 아니라, 여러 고객의 다양한 요구에 부합하는 경제적인 주문형 제품 또한 품질에 대한 자신감을 담아 생산·공급합니다.

품질로써 고객에게 확신을 드리는 박스코는 지속적인 품질향상에 대한 투자 및 연구개발을 부지런히 진행하며 변화의 속도가 점점 빨라지는 글로벌 시장에 적극 대응할 수 있도록 노력하고 있습니다.

박스코는 고객여러분들의 변함없는 관심과 성원에 힘입어,

앞으로도 끊임없는 변화를 추구하고 고품질의 제품과 서비스 그리고 경쟁력 있는 가격으로 고객에게 신뢰와 만족감을 드리겠습니다.

감사합니다.

INDUSTRIAL AUTOMATION

— BOXCO是一家专业生产电子电气密封防水盒的公司，其产品主要用于保护内部电气元件及电子控制仪器。

我们拥有大型生产设备与高效的供给体系，旨在向全世界的顾客提供高品质的产品与服务，并提供符合客户要求的经济定制产品和标准产品。

我们一直努力为提高客户满意度和企业形象而不断研究与发展，以合理的物流管理和友好的服务态度回报我们的客户。

感谢各位客户一如既往的关注与支持。

谢谢!

History 연혁 / 历史

- | | | | |
|---|--|---|---|
| <p>1996. 05</p> <p>1999. 04</p> <p>2006. 12</p> <p>2007. 03</p> <p>2007. 05</p> <p>2007. 06</p> <p>2007. 09</p> <p>2008. 06</p> <p>2009. 02</p> <p>2009. 04</p> <p>2011. 02</p> <p>2011. 07</p> <p>2011. 10</p> <p>2011. 11</p> <p>2011. 12</p> <p>2012. 02</p> <p>2012. 05</p> <p>2012. 06</p> <p>2012. 08</p> <p>2012. 09</p> <p>2012. 10</p> <p>2012. 11</p> <p>2012. 12</p> <p>2013. 02</p> <p>2013. 03</p> <p>2013. 06</p> <p>2013. 07</p> <p>2013. 08</p> <p>2013. 09</p> <p>2013. 12</p> <p>2014. 03</p> <p>2014. 05</p> <p>2014. 07</p> <p>2014. 12</p> <p>2015. 01</p> <p>2015. 04</p> <p>2015. 06</p> <p>2015. 11</p> <p>2017. 04</p> <p>2017. 08</p> <p>2017. 09</p> | <ul style="list-style-type: none"> • Established Electrical & Electronic Enclosure Company • Changed to Corporation • Obtained ISO 14001 : 2004 • Obtained ISO 9001:2000 • Opened Guro Branch Office in Seoul(Sales) • Obtained K mark • Selected as Prospective small and medium enterprise • Selected as Management Innovation Business • Obtained TUV mark from Germany • Obtained CE mark • Designated as a Promising Export Firm by the Small & Medium Business Administration • Passed SGS, RoHS test • Obtained DIN mark from Germany • Opened Anyang Branch Office in Gyeonggi Province (Sales) • Selected as one of 2011 New Exporters 300 Enterprises • Authorized as an Approved exporter • Obtained UL508A of USA • Certified Clean enterprise • Conclusion of Family Company MOU with Korea Maritime and Ocean University • Received official commendation from Knowledge and Economy Minister • Conclusion of Industrial Cooperation MOU with Korea Maritime and Ocean University • Received official commendation from Minister of SME's and Startups • Gained official recognition for his services to foreign trade • Selected as Innovation Business • Selected as Venture Business • Received official commendation from Knowledge and Economy Minister • Top winner of Korea Brand Power • Designated as a member of IBK CORPORATE FAMILY - a club of VIP corporate clients • Designated as Promising Company by the Industrial Bank of Korea • The top innovation leader, leading Korea • Won the grand prize in The Best Korea Awards • Awarded the Grand Prize of Customer Satisfaction & Power Korea • Selected as Leading Company of Busan • Received the grand prize in Korea Technology Innovation Awards • Selected as Company Strengthening of exportability • Received official commendation from CEO of Korea International Trade Association • Selected as BS DIAMOND GROUP by Busan Bank • Selected as Honorary Branch by Busan Bank • Selected as "The Company where wants to work" by Kyungnam College of Information & Technology • Conclusion of Family Company MOU with Tongmyong University • Conclusion of Industrial Cooperation MOU with Pusan National University • Conclusion of Family Company MOU with Silla University • Selected as Excellent enterprise in Busan • Awarded Venture businessman prize from Busan city mayor • Awarded excellent small medium businessman prize by the administrator of Busan • Ulsan Small Medium Business Administration in management innovation • Received the grand prize in Korea hidden champion CEO awards • Conclusion of Industrial Cooperation MOU with Dong-A university • Won official commendation from the minister of education • Received a plaque of appreciation from the head of ABS division, LG Chem, Ltd. • Conclusion of an agreement with Busan Future Research Center from Pukyong National University • Established Enterprise Research Institute • Designated as Gazelle Company • Selected as Excellent Employment Company of Busan • Won an excellence award in Busan Employment Grand Prize • Appointed company for military service • Conclusion of Track Cooperation with Gyeongnam Provincial Geochang College • Awarded by Busan city mayor • Designated Venture business innovation procurement goods by Busan City • Awarded the prime minister's commendation | <ul style="list-style-type: none"> • 전기, 전자 박스 전문 회사 설립 • 법인 회사로 변경 설립 • ISO 14001: 2004 환경 경영 시스템 인증 획득 • ISO 9001: 2000 품질 경영 시스템 인증 획득 • 구로전시판매장 설립 • 한국 K 마크 획득 • 유망 중소기업 선정 • 경영혁신형 중소기업 선정 • 독일 TUV 마크 획득 • 유럽 연합의 CE 마크 획득 • 수출 유망 중소기업 선정 • 스위스 SGS, RoHS 시험 통과 • 독일 DIN 마크 획득 • 안양전시판매장 설립 • NEW EXPORTERS 300 기업 선정 • 원산지 인증 수출자 인증 • 미국 UL508A 인증 • 클린 사업장 인증 • 한국해양대학교 가족회사 협약 • 지식경제부장관 표창 • 한국해양대학교 산학협력 협약 • 중소기업청장 표창 • 대한무역투자진흥공사사장 유공표창 • 기술혁신형 중소기업 선정 • 벤처기업 선정 • 지식경제부 장관 표창 • 대한민국브랜드파워대상 • 기업은행 패밀리기업 지정 • 기업은행 유망중소기업 선정 • 한국을 이끄는 혁신리더 대상 • 지식경제부장관 표창 • 고객감동 & 파워코리아 대상 • 부산광역시 선도기업 인증 • 대한민국 기술혁신대상 • 수출 역량 강화 대상 기업 선정 • 한국무역협회회장 표창 • BS DIAMOND GROUP 선정 • 부산은행 명예지점 위촉 • 경남정보대학교 취업하고 싶은 기업체 인증 • 동명대학교 가족회사 협약 • 부산대학교 산학협력 협약 • 신라대학교 가족회사 협약 • 부산광역시 우수기업 선정 • 부산광역시 부산벤처기업인상 • 부산울산지방중소기업청장 경영혁신부문 • 우수중소기업상 • 대한민국 강소기업 경영자 대상 • 동아대학교 산학협력 협약 • 교육부장관 표창 • (주)LG화학 ABS사업부장 감사패 • 부경대학교 부산미래연구센터 협약 • 기업부설연구소 설립 • 고성창(가젤)기업 지정 • 부산광역시 고용우수기업 인증 • 부산고용대상 우수상 • 병역지정업체 선정 • 경상도립 남해대학 트랙 협약 • 부산광역시장 표창 • 부산광역시 벤처창업혁신조달상품 지정 • 국무총리 표창 | <ul style="list-style-type: none"> • 成立专业电器电子装配箱公司 • 成立法人公司 • 获得ISO 14001: 2004 环境管理系统认证 • 获得ISO 9001: 2000 国际品质管理系统认证 • 成立九老营业所 • 获得韩国K认证 • 被评选为希望中小企业 • 被评选为经营革新型中小企业 • 获得德国TUV认证 • 获得欧盟CE认证 • 被评选为出口希望中小企业 • 通过瑞士SGS, RoHS测试 • 获得德国DIN认证 • 成立安阳营业所 • 被评选为 NEW EXPORTERS 300强企业 • 获得出口原产地认证 • 获得美国UL508A认证 • 获得绿色环保型企业认证 • 成为韩国海洋大学家族企业 • 荣获知识经济部部长表彰 • 与韩国海洋大学签订产学研合作协议 • 获得中小企业厅长表彰 • 荣获大韩贸易投资振兴公社社长有功表彰 • 被评为技术创新型中小企业 • 被评为风险企业 • 荣获知识经济部部长表彰 • 荣获韩国品牌力量大奖 • 被评为企业银行家族企业 • 被评为企业银行希望中小企业 • 荣获引导韩国创新龙头企业大奖 • 荣获知识经济部部长表彰 • 荣获顾客监督与力量韩国大奖 • 荣获顾客监督与力量韩国大奖 • 荣获韩国技术创新大奖 • 被评为出口力量强化对象企业 • 荣获韩国贸易协会会长表彰 • 被评为BS DIAMOND GROUP • 被评为釜山银行名誉分行 • 被庆南信息大学评为"希望就业公司" • 成为东明大学家族企业 • 与釜山大学签订产学研合作协议 • 成为新罗大学家族企业 • 被评为釜山广域市优秀企业 • 荣获釜山广域市市长颁发的釜山风险企业人奖项 • 荣获釜山蔚山地方中小企业厅长颁发的经营创新 • 单元优秀中小企业奖项 • 荣获韩国强小企业经营者大奖 • 与东亚大学签订产学研合作协议 • 荣获教育部部长表彰 • 获(株)LG化学ABS事业部部长赠予感谢牌 • 与金庆大学协议创办釜山未来研究中心 • 成立企业附属研究所 • 被评为高增长企业 • 获得釜山广域市雇用优秀企业认证 • 荣获釜山雇用大奖优秀奖 • 被评选为服役役特定企业 • 与庆尚道立南海大学签订合作协议 • 荣获釜山广域市市长表彰 • 被评选为釜山广域市风险创业创新采购商品 • 荣获国务总理表彰 |
|---|--|---|---|

Certification 인증현황 / 认证现状



- SBCR에서 발행한 ISO 9001 (품질경영시스템인증) 획득
- ISO 9001 approved from SBCR
- 获得瑞士SBCR的ISO9001质量体系认证

- AC 600v 이하 옥내, 옥외의 전기설비에 사용하는 합성수지제박스 규격인증 KTL C067-2007
- Standard Certification KTL C067-2007 for resin box used in indoor and outdoor electrical equipment below AC 600v
- 获得室内外600V一下的电气设备的KTL C067-2007标准认证



- UL(미국보험협회 시험소)에서 UL508A 인증 획득
 - Obtained UL508A certification from UL(Underwriters Laboratories)
 - 获得美国保护协会研究所获得UL508A 认证
- Ratings / 등급 / 等级 : TYPE 4X/TYPE 6

- 한국건자재시험연구원(KICM)에서 PC난연테스트 UL94 : 2003인증
- Passed in Combustion Resistance Test UL94:2003 of Korea Institute of Construction Materials
- 获得韩国建材实验研究院(KICM)出具的PC难燃测试 UL94:2003认证



- 유럽공동체(유럽연합) 관장하의 범유럽차원의 시험인증기관 EOTC의 EN(유럽규격)에 의한 승인을 통과함
- Obtained Certificate of CE by EN from EOTC (European Organization for Testing and Certification)
- 通过EOTC 出具的欧洲CE认证

- 한국생활환경시험연구원 (KEMTI)에서 PC/ABS, PC, PBT/PC 난연테스트 V-0 인증
- Passed in Combustion Resistance Test of V-0 for PC/ ABS, PC, PBT/ PC from Korea Environment and Merchandise Testing Institute
- 获得韩国生活环境试验研究院 (KEMTI) 出具的PC难燃测试V-0认证



- 독일 TUV 라인란드로부터 플라스틱 엔클로저 TUV마크, IP67, IK08 획득
- Obtained Germany TUV cert with IP67, IK08 rating for plastic enclosures
- 塑料制品获得德国TUV认证, IP67和IK08

- 스위스 제네바에 본사를 둔 인증기관으로서 SGS에서 유해물질 제한지침(ROHS) 검증 받음
- Obtained RoHS certification from SGS, world's leading inspection in Geneva, Swiss
- 作为认证机构, 总部设在瑞士日内瓦, 来自SGS (ROHS) 验证明星限制有害物质指令

UL508A Certification list

UL508A 인증리스트 / 获得UL508A认证的产品

Type 4x

- BC-CGQ, BC-CGP, BC-CGH, BC-CGM, BC-CGS Series
- BC-CTP, BC-CTH, BC-CTM, BC-CTS Series

Type 6

- BC-CGS, BC-CTS Series

Q series	BC-□□P-203018	BC-□□H-406023	BC-□□H-082508	BC-□□M-131806	BC-□□S-121207
BC-□□Q-101509	BC-□□P-253515	BC-□□H-604023	BC-□□H-250808	BC-□□M-151806	BC-□□S-121210
BC-□□Q-151509	BC-□□P-253518	BC-□□H-191913	BC-□□H-101007	BC-□□M-181806	BC-□□S-121707
BC-□□Q-151512	BC-□□P-282813	BC-□□H-192810	BC-□□H-101010	BC-□□M-181807	BC-□□S-121710
BC-□□Q-162110	BC-□□P-283813	BC-□□H-281910	BC-□□H-121207	BC-□□M-181810	BC-□□S-141709
BC-□□Q-162113	BC-□□P-303015	BC-□□H-192813	BC-□□H-121210	BC-□□M-181812	BC-□□S-142309
BC-□□Q-212113	BC-□□P-303018	BC-□□H-281913	BC-□□H-121707	BC-□□M-182507	BC-□□S-151507
BC-□□Q-203013	BC-□□P-304012	BC-□□H-192818	BC-□□H-171207	BC-□□M-182510	BC-□□S-151510
BC-□□Q-203015	BC-□□P-304015	BC-□□H-281918	BC-□□H-121710	BC-□□M-182512	BC-□□S-152004
BC-□□Q-203018	BC-□□P-304018	BC-□□H-193813	BC-□□H-171210	S series	BC-□□S-152007
BC-□□Q-253516	BC-□□P-353515	BC-□□H-381913	BC-□□H-141709	BC-□□S-191913	BC-□□S-152010
BC-□□Q-303016	BC-□□P-353518	BC-□□H-193818	BC-□□H-171409	BC-□□S-192810	BC-□□S-152013
BC-□□Q-304016	BC-□□P-354512	BC-□□H-381918	BC-□□H-142309	BC-□□S-192813	BC-□□S-152016
BC-□□Q-304018	BC-□□P-354516	BC-□□H-282813	BC-□□H-231409	BC-□□S-192818	BC-□□S-152010
BC-□□Q-354520	BC-□□P-354520	BC-□□H-283413	BC-□□H-151507	BC-□□S-193813	BC-□□S-152513
BC-□□Q-405016	BC-□□P-405016	BC-□□H-342813	BC-□□H-151510	BC-□□S-193818	BC-□□S-161607
BC-□□Q-405020	BC-□□P-405020	BC-□□H-283813	BC-□□H-152007	BC-□□S-282813	BC-□□S-202010
	BC-□□P-406018	BC-□□H-382813	BC-□□H-201507	BC-□□S-283413	BC-□□S-202013
P series	BC-□□P-406023	BC-□□H-283818	BC-□□H-152010	BC-□□S-283813	BC-□□S-202016
BC-□□P-091207	BC-□□P-506018	BC-□□H-382818	BC-□□H-201510	BC-□□S-285613	BC-□□S-212310
BC-□□P-091208	BC-□□P-506025	BC-□□H-285613	BC-□□H-152013	BC-□□S-334318	Push button series
BC-□□P-101507	BC-□□P-507018	BC-□□H-562813	BC-□□H-201513	BC-□□S-385618	BC-□GS-081107-2201
BC-□□P-101508	BC-□□P-507025	BC-□□H-334318	BC-□□H-152016	BC-□□S-050604	BC-□GS-081108-2201
BC-□□P-112107	BC-□□P-608018	BC-□□H-433318	BC-□□H-201516	BC-□□S-050605	BC-□GS-081307-2202
BC-□□P-112110	BC-□□P-608028	BC-□□H-385618	BC-□□H-152510	BC-□□S-060905	BC-□GS-081308-2202
BC-□□P-112607	H series	BC-□□H-563818	BC-□□H-152510	BC-□□S-071005	BC-□GS-081807-2203
BC-□□P-112610	BC-□□H-222712	BC-□□H-081107	BC-□□H-251510	BC-□□S-080806	BC-□GS-081808-2203
BC-□□P-131508	BC-□□H-272212	BC-□□H-110807	BC-□□H-152513	BC-□□S-081104	BC-□GS-082507-2204
BC-□□P-131808	BC-□□H-203015	BC-□□H-081108	BC-□□H-251513	BC-□□S-081107	BC-□GS-082508-2204
BC-□□P-131810	BC-□□H-302015	BC-□□H-110808	BC-□□H-202010	BC-□□S-081108	BC-□GS-081107-2501
BC-□□P-151509	BC-□□H-203018	BC-□□H-081110	BC-□□H-202013	BC-□□S-081110	BC-□GS-081108-2501
BC-□□P-151512	BC-□□H-302018	BC-□□H-110810	BC-□□H-202016	BC-□□S-081307	BC-□GS-081307-2502
BC-□□P-162110	BC-□□H-253515	BC-□□H-081307	BC-□□H-212310	BC-□□S-081308	BC-□GS-081308-2502
BC-□□P-162113	BC-□□H-352515	BC-□□H-130807	BC-□□H-232110	BC-□□S-081605	BC-□GS-081807-2503
BC-□□P-162610	BC-□□H-304015	BC-□□H-081308	M series	BC-□□S-081608	BC-□GS-081808-2503
BC-□□P-162613	BC-□□H-403015	BC-□□H-130808	BC-□□M-081303	BC-□□S-081807	BC-□GS-082507-2504
BC-□□P-172211	BC-□□H-304018	BC-□□H-081807	BC-□□M-081306	BC-□□S-081808	BC-□GS-082508-2504
BC-□□P-172711	BC-□□H-403018	BC-□□H-180807	BC-□□M-081307	BC-□□S-082007	BC-□GS-081107-3001
BC-□□P-212110	BC-□□H-354516	BC-□□H-081808	BC-□□M-081308	BC-□□S-082507	BC-□GS-081108-3001
BC-□□P-212113	BC-□□H-453516	BC-□□H-180808	BC-□□M-081310	BC-□□S-082508	BC-□GS-081307-3002
BC-□□P-192810	BC-□□H-354520	BC-□□H-082007	BC-□□M-081312	BC-□□S-101007	BC-□GS-081308-3002
BC-□□P-192814	BC-□□H-453520	BC-□□H-200807	BC-□□M-131303	BC-□□S-101010	BC-□GS-081807-3003
BC-□□P-203013	BC-□□H-405020	BC-□□H-082507	BC-□□M-131306	BC-□□S-101807	BC-□GS-081808-3003
BC-□□P-203015	BC-□□H-504020	BC-□□H-250807	BC-□□M-131803	BC-□□S-102007	BC-□GS-082507-3004
				BC-□□S-102307	BC-□GS-082508-3004

IP·IK Ratings IP·IK 보호등급 / IP·IK 保护等级

① ② ③
IP - 0 0

① ②
IK - 0 0

- IEC(International Electrotechnical Commission) defines protection structure of electric instruments or protection boxes as follows.
- 국제 전기업 협회(IEC)는 전기 기기나 보호 상자의 보호 구조에 대하여 아래와 같이 규정하고 있습니다.
- 国际电工委员会对电气类产品的保护等级测试标准如下.

- ① 보호등급기호
- ② 제 1 특성 : 고체에 대한 보호정도
- ③ 제 2 특성 : 액체에 대한 보호정도

- ① 보호등급기호
- ② 보호등급

1 Protection against solid 고체에 대한 보호		2 Protection against liquid 액체에 대한 보호		IK code Protection against mechanical impact 충격에 대한 보호정도	
IP	Test / 테스트	IP	Test / 테스트	IK	Test / 테스트
0	No protection 보호안됨	0	No protection 보호안됨	0	No protection 보호안됨
1	Protected against solid objects up to 50mm, e.g. accidental touch by hands. 50mm이상의 고체로부터 보호됨 (손에 닿는 정도)	1	Protection against vertically falling drops of water. 수직으로 떨어지는 물방울로부터 보호됨	1-5	Impact < 1 joule 충격 < 1 joule
2	Protected against solid objects up to 12mm, e.g. fingers. 12mm이상의 고체로부터 보호됨 (손가락 크기 정도)	2	Protection against direct sprays of water up to 15° from the vertical. 수직에서 15° 범위에서 분사되는 물로부터 보호됨	6	Impact = 1 joule 충격 = 1 joule
3	Protected against solid objects over 2.5mm (tools and wires). 2.5mm 이상의 고체로부터 보호됨 (연장, 전선크기)	3	Protection against direct sprays of water up to 60° from the vertical. 수직에서 60° 범위에서 분사되는 물로부터 보호됨	7	Impact = 2 joule 충격 = 2 joule
4	Protected against solid objects over 1mm (tools, wires and small wire). 1mm이상의 고체로부터 보호됨 (가는 연장, 가는 전선)	4	Protection against water sprays from all directions-limited ingress permitted. 모든 방향에서 분사되는 물로부터 보호됨	8	Impact = 5 joule 충격 = 5 joule
5	Protected against dust limited ingress. 먼지로부터 보호됨	5	Protected against low pressure jets of water from all directions-limited ingress. 모든 방향에서 낮은 압력으로 분사되는 물로부터 보호됨	9	Impact = 10 joule 충격 = 10 joule
6	Totally protected against dust. 먼지로부터 완벽하게 보호됨	6	Protected against strong pressure jets of water from all directions-limited ingress permitted. 모든 방향에서 높은 압력으로 분사되는 물로부터 보호됨	10	Impact = 20 joule 충격 = 20 joule
		7	Protected against the effects of temporary immersion between 15cm and 1m in water. 15cm ~ 1m까지 30분동안 침수되어도 보호됨		
		8	Protected against the effects of continuous immersion in water. 장기간 침수되어 수압을 받아도 보호됨		

Customize 주문제작 / 定制

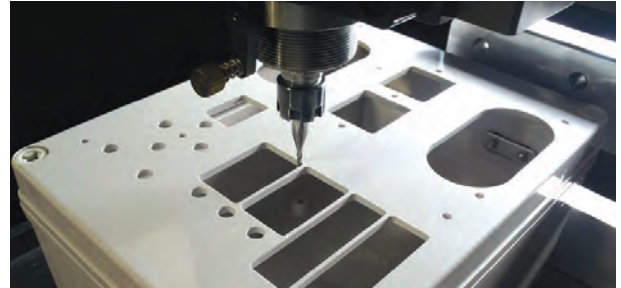

Custom Products

제품 주문 제작 가능 | 生产定制的产品

- We can make any size and shape of enclosures to meet your requirement.
- 박스코는 고객의 사양에 따라 다른 모양과 사이즈의 제품을 주문 제작하여 드립니다.
- 按照客户的要求，非标准的形式可以定制。

Custom holes & Cutout service

조각기 가공 서비스 | 电刻机加工服务

- We can meet on customer's various request by a delicate machining and drilling technology on the basis of accumulated experience. (can be applied to the side of box)
- 박스코는 축적된 경험을 바탕으로 정교한 홀가공기술로 고객의 다양한 요구에 부응합니다. (측면가공 가능)
- BOXCO以丰富的经验为基础为客户提供各种要求的冲孔加工服务。(箱体的侧面也可以)

INDUSTRIAL AUTOMATION



Printing service

실크스크린 및 문자조각 서비스 | 丝印及文字加工服务

- A vivid silk-screen printing and letter sculpturing service make your products more beautiful.
- 선명하게 인쇄되는 실크스크린과 문자 조각으로 귀사 제품을 한층 돋보이게 합니다.
- 丝印及文字加工印刷服务让你的产品更出色。



Coloring service

색상서비스 | 颜色选择服务

- We produce high quality enclosure with a different color.
- 다양한 색상으로 소비자가 원하는 고품질 엔클로저를 생산, 공급하여 드립니다.
- 按客户要求提供各种颜色的高品质箱体。

01

PLASTIC BOX

플라스틱 박스
塑料盒



HINGE TYPE	SCREW TYPE
Q Series	M Series
R Series	U Series
P Series	S Series
D Series	Knock-out Box
UH Series	Push Button Box
H Series	Terminal Block Box
SMPS Case	BC-AB-111108
CONCENT Case	

힌지 타입	스크류 타입
Q 시리즈	M 시리즈
R 시리즈	U 시리즈
P 시리즈	S 시리즈
일체형 이중도어	녹아웃 박스
UH 시리즈	푸시버튼 박스
H 시리즈	단자박스
SMPS 박스	BC-AB-111108
CONCENT 박스	

铰链型	螺栓型
Q 系列	M 系列
R 系列	U 系列
P 系列	S 系列
一体型双层门	敲落孔盒
UH 系列	按钮盒
H 系列	端子盒
SMPS 盒	BC-AB-111108
CONCENT 盒	

• Dimensions and specifications are subject to change without notice.

• 규격 및 사양은 사전 예고 없이 변경될 수 있습니다.

• 厂家会在没有任何提前通知的情况下更改产品规格与样式。

Q Series

Q 시리즈
Q 系列

100x150x90 ~ 400x500x200mm

FEATURE | 특성 | 特征

- Plastic hinge, Plastic latch
- It is easy to removable cover and body
- 플라스틱 힌지, 플라스틱 래치 타입
- 커버, 베이스 탈부착 용이
- 带有塑料合页与塑料锁扣的产品
- 容易分开盒体和盒盖

SPECIFICATION | 사양 | 产品规格说明

- IP Rating / 방수, 방진 보호등급 / 防尘防水等级 | IP66/67
- IK Rating / 충격 테스트 / 冲击测试 | IK08
- Temperature Range / 온도영역 / 温度范围 | ABS : - 40 ~ + 70, PC : - 40 ~ + 110
- Flammability Rating / 난연성 / 阻燃等级 | ABS : 94-HB, PC : 94-V-0, 5VA, HB
- Certification / 인증 / 认证 | TUV, CE, UL (See page 6 / 6 페이지 참조 / 请参照第6页)

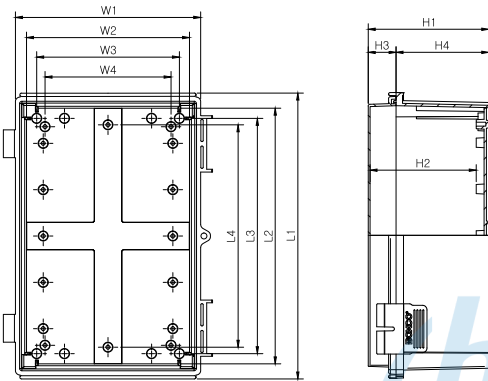

Q SERIES model name | Q 시리즈 모델선정방법 | Q 系列 产品型号命名方法

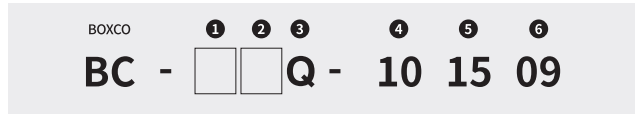

- ① Material / 재료 / 材质 - A : ABS C : PC
- ② Cover / 커버색상 / 箱盖颜色 - G : Grey / 회색 / 灰色 T : Transparent / 투명 / 透明
- ③ Type / 타입 / 类型 - Plastic Latch / 플라스틱 래치 / 塑料锁扣
- ④ Width / 가로 / 宽度(W)
- ⑤ Length / 세로 / 长度(L) - Hinge, Latch Installed / 힌지, 래치부착면 / 铰链, 锁扣安装面
- ⑥ Height / 높이 / 高度(H) - Cover Included / 커버포함 / 含箱盖

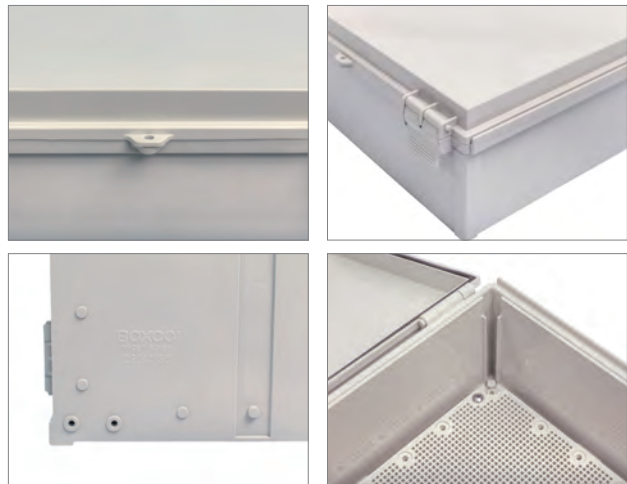

Model 모델 / 型号	Product model / 제품모델 / 产品型号					Mounting plate / 속판모델 / 底板型号		
	Outside dimension 외부 치수 / 外部尺寸				Inside dimension 내부 치수 / 内部尺寸	Steel 철 / 金属	Plastic 플라스틱 / 塑料	
	Size (W1xL1xH1/mm)	Size (W1xL1xH1/inch)	Cover (H3)	Base (H4)	Size (W2xL2xH2/mm)		G-type 사각형홀	C-type 체크형
BC- □□Q- 101509	100 x 150 x 90	3.94 x 5.91 x 3.54	20	70	76 x 126 x 78	-	1015 G	-
BC- □□Q- 151509	150 x 150 x 90	5.91 x 5.91 x 3.54	20	70	129 x 129 x 78	1515 SQ	1515 G	-
BC- □□Q- 151512	150 x 150 x 120	5.91 x 5.91 x 4.72	20	100	129 x 129 x 108	1515 SQ	1515 G	-
BC- □□Q- 162110	160 x 210 x 100	6.30 x 8.27 x 3.94	20	80	136 x 186 x 88	1621 SQ	1621 G	-
BC- □□Q- 162113	160 x 210 x 130	6.30 x 8.27 x 5.12	20	110	136 x 186 x 118	1621 SQ	1621 G	-
BC- □□Q- 212113	210 x 210 x 130	8.27 x 8.27 x 5.12	20	110	183 x 183 x 118	2121 SQ	2121 G	-
BC- □□Q- 203013	200 x 300 x 130	7.87 x 11.81 x 5.12	30	100	175 x 275 x 114	2030 SQ	2030 G	2030 C
BC- □□Q- 203014	200 x 300 x 140	7.87 x 11.81 x 5.51	30	110	175 x 275 x 104	2030 SQ	2030 G	2030 C
BC- □□Q- 203015	200 x 300 x 150	7.87 x 11.81 x 5.91	30	120	175 x 275 x 134	2030 SQ	2030 G	2030 C
BC- □□Q- 203018	200 x 300 x 180	7.87 x 11.81 x 7.09	30	150	175 x 275 x 164	2030 SQ	2030 G	2030 C
BC- □□Q- 253516	250 x 350 x 160	9.84 x 13.78 x 6.30	30	130	225 x 325 x 144	2535 SQ	2535 G	2535 C
BC- □□Q- 303016	300 x 300 x 160	11.81 x 11.81 x 6.30	30	130	270 x 270 x 144	3030 SQ	3030 G	3030 C
BC- □□Q- 304015	300 x 400 x 150	11.81 x 15.75 x 5.91	30	120	275 x 375 x 141	3040 SQ	3040 G	3040 C
BC- □□Q- 304016	300 x 400 x 160	11.81 x 15.75 x 6.30	30	130	275 x 375 x 144	3040 SQ	3040 G	3040 C
BC- □□Q- 304018	300 x 400 x 180	11.81 x 15.75 x 7.09	30	150	275 x 375 x 164	3040 SQ	3040 G	3040 C
BC- □□Q- 354520	350 x 450 x 200	13.78 x 17.72 x 7.87	30	170	317 x 417 x 183	3545 SQ	3545 G	-
BC- □□Q- 405016	400 x 500 x 160	15.75 x 19.69 x 6.30	30	130	369 x 469 x 143	4050 SQ	4050 G	-
BC- □□Q- 405020	400 x 500 x 200	15.75 x 19.69 x 7.87	30	170	369 x 469 x 183	4050 SQ	4050 G	-

ACCESSORIES | 액세서리 | 配件

INDUSTRIAL AUTOMATION

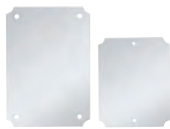

[Steel mounting plate(SQ Plate)]

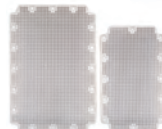

[Plastic mounting plate(G Plate)]



[Plastic mounting plate(C Plate)]



[Key ring(K40)]



[Lock(SK)]



[Plastic lock(PK)]



[SUS bracket(B40, B50)]

B40 : Q-101509~Q-212113(Screw : TTS 4x10)
B50 : Q-203013~Q-405020(Screw : TTS 5x10)



[Plastic bracket(PB40, PB50)]

PB40 : Q-101509~Q-212113(Screw : TTS 4x12)
PB50 : Q-203013~Q-405020(Screw : TTS 5x12)



[Vent(V60, V80)]

R Series

R 시리즈
R 系列

100x150x75 ~ 610x810x260mm

FEATURE | 특성 | 特征

- SUS hinge pin, SUS latch
- It is easy to removable cover and base
- 스텐레스 힌지핀, 스텐레스 래치 타입
- 커버, 베이스 탈부착 용이
- SUS铰链柱, 采用SUS锁
- 容易分开盒体和盒盖

SPECIFICATION | 사양 | 产品规格说明

- Temperature Range / 온도영역 / 温度范围 | ABS : -40 ~ +70, PC : -40 ~ +110
- Flammability Rating / 난연성 / 阻燃等级 | ABS : 94-HB, PC : 94-V-0, 5VA, HB

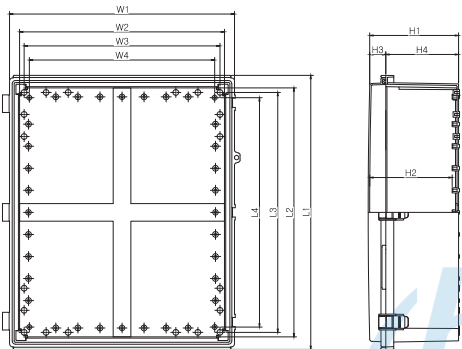

R SERIES model name | R 시리즈 모델선정방법 | R 系列 产品型号命名方法

BOXCO ① ② ③ ④ ⑤ ⑥

BC - [] [] R - 15 15 10

- ① Material / 재료 / 材质 - A : ABS C : PC
- ② Cover / 커버색상 / 箱盖颜色 - G : Grey / 회색 / 灰色 T : Transparent / 투명 / 透明
- ③ Type / 타입 / 类型 - SUS Latch / SUS 래치 / SUS 锁扣
- ④ Width / 가로 / 宽度(W)
- ⑤ Length / 세로 / 长度(L) - Hinge, Latch Installed / 힌지, 래치부착면 / 铰链, 锁扣安装面
- ⑥ Height / 높이 / 高度(H) - Cover Included / 커버포함 / 含箱盖

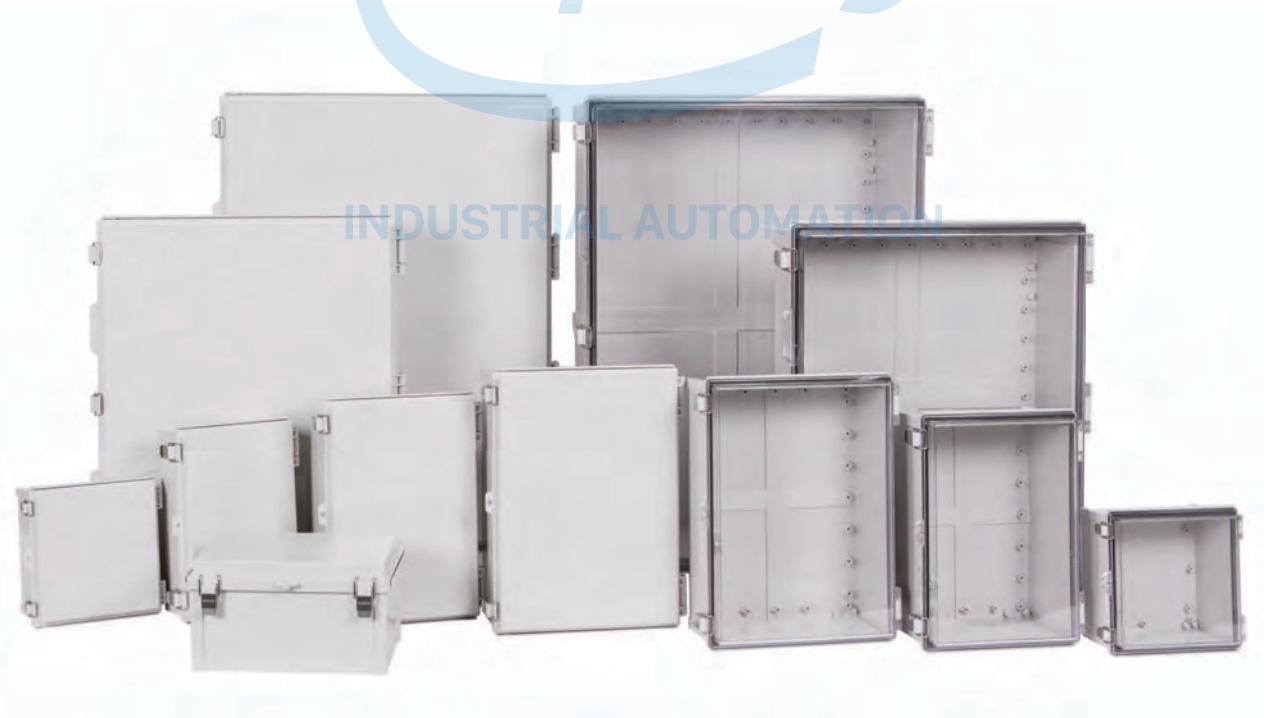

Product model / 제품모델 / 产品型号							Mounting plate / 속판모델 / 底板型号		
Model 모델 / 型号	Outside dimension 외부 치수 / 外部尺寸				Inside dimension 내부 치수 / 内部尺寸		Steel 철 / 金属	Plastic 플라스틱 / 塑料	
	Size (W1xL1xH1/mm)	Size (W1xL1xH1/inch)	Cover (H3)	Base (H4)	Size (W2xL2xH2/mm)	G-type 사각형홀		C-type 체크형	
NEW BC - □□R - 101507	100 x 150 x 75	3.94 x 5.91 x 2.95	25	50	78 x 128 x 61	1015 SQ	1015 G	-	
NEW BC - □□R - 101509	100 x 150 x 95	3.94 x 5.91 x 3.74	25	70	78 x 128 x 81	1015 SQ	1015 G	-	
BC - □□R - 151510	150 x 150 x 95	5.91 x 5.91 x 3.74	25	70	131 x 131 x 82	1515 SQ	1515 G	-	
BC - □□R - 162111	160 x 210 x 105	6.30 x 8.27 x 4.13	25	80	138 x 188 x 92	1621 SQ	1621 G	-	
BC - □□R - 162114	160 x 210 x 135	6.30 x 8.27 x 5.32	25	110	138 x 188 x 122	1621 SQ	1621 G	-	
BC - □□R - 162611	160 x 260 x 105	6.30 x 10.24 x 4.13	25	80	134 x 235 x 92	1626 SQ	1626 G	-	
BC - □□R - 162614	160 x 260 x 135	6.30 x 10.24 x 5.32	25	110	134 x 235 x 122	1626 SQ	1626 G	-	
BC - □□R - 212114	210 x 210 x 135	8.27 x 8.27 x 5.32	25	110	185 x 185 x 120	2121 SQ	2121 G	-	
BC - □□R - 192810	190 x 280 x 100	7.48 x 11.02 x 3.94	30	70	164 x 253 x 85	1928 SQ	1928 G	-	
BC - □□R - 203013	200 x 300 x 130	7.87 x 11.81 x 5.12	30	100	174 x 273 x 115	2030 SQ	2030 G	2030 C	
BC - □□R - 203016	200 x 300 x 160	7.87 x 11.81 x 6.30	30	130	174 x 273 x 145	2030 SQ	2030 G	2030 C	
BC - □□R - 203018	200 x 300 x 180	7.87 x 11.81 x 7.09	30	150	174 x 273 x 165	2030 SQ	2030 G	2030 C	
BC - □□R - 203021	200 x 300 x 210	7.87 x 11.81 x 8.27	30	180	174 x 273 x 195	2030 SQ	2030 G	2030 C	
BC - □□R - 253516	250 x 350 x 160	9.84 x 13.78 x 6.30	30	130	229 x 329 x 145	2535 SQ	2535 G	2535 C	
BC - □□R - 253518	250 x 350 x 180	9.84 x 13.78 x 7.09	30	150	229 x 329 x 165	2535 SQ	2535 G	2535 C	
BC - □□R - 303016	300 x 300 x 160	11.81 x 11.81 x 6.30	30	130	273 x 273 x 150	3030 SQ	3030 G	3030 C	
BC - □□R - 303018	300 x 300 x 180	11.81 x 11.81 x 7.09	30	150	273 x 273 x 170	3030 SQ	3030 G	3030 C	
BC - □□R - 304016	300 x 400 x 160	11.81 x 15.75 x 6.30	30	130	280 x 380 x 145	3040 SQ	3040 G	3040 C	
BC - □□R - 304018	300 x 400 x 180	11.81 x 15.75 x 7.09	30	150	280 x 380 x 165	3040 SQ	3040 G	3040 C	
BC - □□R - 354517	350 x 450 x 170	13.78 x 17.72 x 6.69	40	130	415 x 315 x 160	3545 SQ	3545 G	-	
BC - □□R - 354521	350 x 450 x 210	13.78 x 17.72 x 8.27	40	170	415 x 315 x 200	3545 SQ	3545 G	-	
BC - □□R - 405017	400 x 500 x 170	15.75 x 19.69 x 6.69	40	130	464 x 364 x 160	4050 SQ	4050 G	-	
BC - □□R - 405021	400 x 500 x 210	15.75 x 19.69 x 8.27	40	170	464 x 364 x 200	4050 SQ	4050 G	-	
BC - □□R - 516116	510 x 610 x 160	20.08 x 24.02 x 6.30	35	125	470 x 570 x 145	5161 SQ	-	5161 C	
BC - □□R - 516120	510 x 610 x 200	20.08 x 24.02 x 7.87	35	165	470 x 570 x 182	5161 SQ	-	5161 C	
BC - □□R - 517120	510 x 710 x 200	20.08 x 27.95 x 7.87	35	165	470 x 670 x 182	5171 SQ	-	5171 C	
BC - □□R - 617120	610 x 710 x 200	24.02 x 27.95 x 7.87	35	165	570 x 670 x 182	6171 SQ	-	6171 C	
BC - □□R - 618126	610 x 810 x 260	24.02 x 31.89 x 10.24	35	225	570 x 770 x 242	6181 SQ	-	6181 C	

INDUSTRIAL AUTOMATION

ACCESSORIES | 액세서리 | 配件



[Steel mounting plate(SQ Plate)]

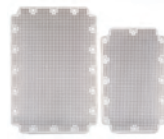

[Plastic mounting plate(G Plate)]



[Plastic mounting plate(C Plate)]



[Key ring(K40)]



[Lock(SK)]



[Plastic lock(PK)]



[Integral lock(PSK15, PPK20, PPK35, PPK50)]



[SUS bracket(B40, B50, B60)]



[Plastic bracket(PB40, PB50)]



[Vent(V60, V80)]

B40 : R-151510~R-212114(Screw : TTS 4x10)
 B50 : R-203013~R-304018(Screw : TTS 5x10)
 B60 : R-516120~R-618126(Screw : TTS 5x10)

PB40 : R-151510~R-212114(Screw : TTS 4x12)
 PB50 : R-203013~R-618126(Screw : TTS 5x12)

P Series

P 시리즈
P 系列

90x120x70 ~ 630x830x285mm

FEATURE | 특성 | 特征

- SUS hinge pin, SUS latch and insert
- It is easy to removable cover and base
- 스텐레스 힌지핀, 스텐레스 래치 타입, 인서트 있는 제품
- 커버, 베이스 탈부착 용이
- SUS铰链柱, 采用SUS锁扣 螺母的产品
- 容易分开盒体和盒盖

SPECIFICATION | 사양 | 产品规格说明

- IP Rating / 방수, 방진 보호등급 / 防尘防水等级 | IP66/67
- IK Rating / 충격 테스트 / 冲击测试 | IK08
- Temperature Range / 온도영역 / 温度范围 | ABS : - 40 ~ + 70, PC : - 40 ~ + 110
- Flammability Rating / 난연성 / 阻燃等级 | ABS : 94-HB, PC : 94-V-0, 5VA, HB
- Certification / 인증 / 认证 | TUV, CE, UL (See page 6 / 6 페이지 참조 / 请参照第6页)

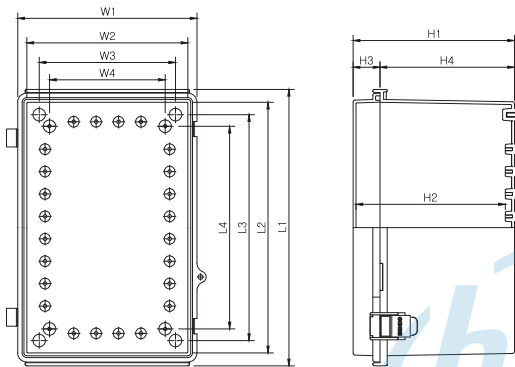

P SERIES model name | P 시리즈 모델선정방법 | P 系列 产品型号命名方法

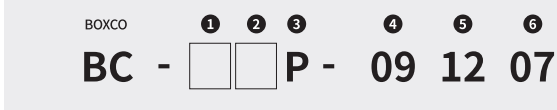

- ① Material / 재료 / 材质 - A : ABS C : PC
- ② Cover / 커버색상 / 箱盖颜色 - G : Grey / 회색 / 灰色 T : Transparent / 투명 / 透明
- ③ Type / 타입 / 类型 - SUS Latch / SUS 래치 / SUS锁扣
- ④ Width / 가로 / 宽度(W)
- ⑤ Length / 세로 / 长度(L) - Hinge, Latch Installed / 힌지, 래치부착면 / 铰链, 锁扣安装面
- ⑥ Height / 높이 / 高度(H) - Cover Included / 커버포함 / 含箱盖

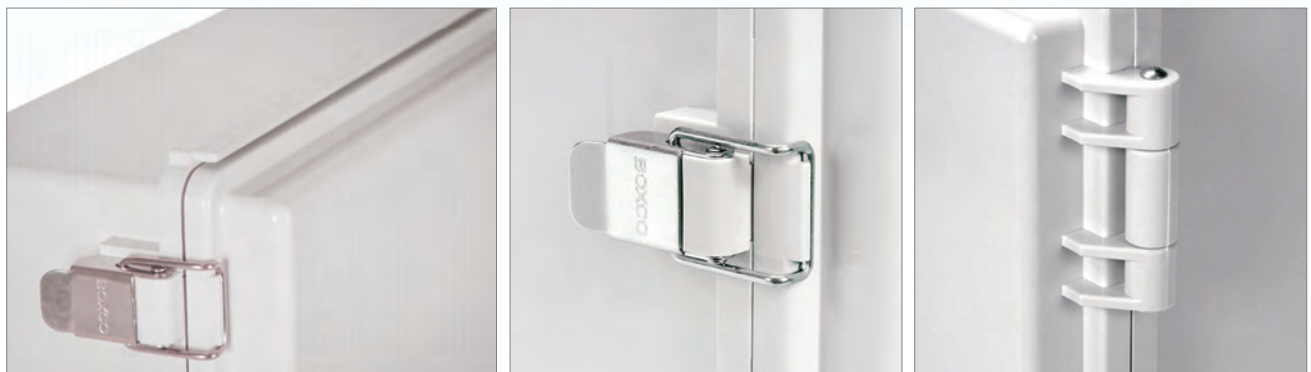

Product model / 제품모델 / 产品型号						Mounting plate / 속판모델 / 底板型号			
Model 모델 / 型号	Outside dimension 외부 치수 / 外部尺寸				Inside dimension 내부 치수 / 内部尺寸		Steel 철 / 金属	Plastic 플라스틱 / 塑料	
	Size (W1xL1xH1/mm)	Size (W1xL1xH1/inch)	Cover (H3)	Base (H4)	Size (W2xL2xH2/mm)	P-type		G-type	
BC-□□P-091207	90 x 120 x 70	3.54 x 4.72 x 2.76	20	50	66 x 97 x 57	0811 S	0811 P	-	
BC-□□P-091208	90 x 120 x 85	3.54 x 4.72 x 3.35	20	65	66 x 97 x 72	0811 S	0811 P	-	
BC-□□P-101507	100 x 150 x 70	3.94 x 5.91 x 2.76	20	50	77 x 127 x 57	0811 S	0813 P	-	
BC-□□P-101508	100 x 150 x 85	3.94 x 5.91 x 3.35	20	65	76 x 126 x 72	0811 S	0813 P	-	
BC-□□P-112107	110 x 210 x 75	4.33 x 8.27 x 2.95	20	55	86 x 186 x 62	1020 S	1020 P	-	
BC-□□P-112110	110 x 210 x 100	4.33 x 8.27 x 3.94	20	80	86 x 186 x 87	1020 S	1020 P	-	
BC-□□P-112607	110 x 260 x 75	4.33 x 10.24 x 2.95	20	55	86 x 236 x 62	1126 S	1126 P	-	
BC-□□P-112610	110 x 260 x 100	4.33 x 10.24 x 3.94	20	80	86 x 236 x 87	1126 S	1126 P	-	
BC-□□P-131508	135 x 155 x 85	5.12 x 5.91 x 3.35	20	65	110 x 131 x 72	1315 S	1315 P	-	
BC-□□P-131808	135 x 185 x 85	5.12 x 7.09 x 3.35	20	65	111 x 161 x 72	1217 S	1217 P	-	
BC-□□P-131810	135 x 185 x 100	5.12 x 7.09 x 3.94	20	80	111 x 161 x 87	1217 S	1217 P	-	
BC-□□P-151509	150 x 150 x 90	5.91 x 5.91 x 3.54	20	70	126 x 126 x 76	1515 S	1515 P	-	
BC-□□P-151512	150 x 150 x 120	5.91 x 5.91 x 4.72	20	100	126 x 126 x 106	1515 S	1515 P	-	
BC-□□P-162110	160 x 210 x 100	6.30 x 8.27 x 3.94	25	75	136 x 186 x 87	1520 S	1520 P	-	
BC-□□P-162113	160 x 210 x 130	6.30 x 8.27 x 5.12	25	105	135 x 185 x 117	1520 S	1520 P	-	
BC-□□P-162610	160 x 260 x 100	6.30 x 10.24 x 3.94	25	75	136 x 236 x 87	1525 S	1525 P	-	
BC-□□P-162613	160 x 260 x 130	6.30 x 10.24 x 5.12	25	105	135 x 235 x 117	1525 S	1525 P	-	
BC-□□P-172211	170 x 220 x 110	6.69 x 8.66 x 4.33	30	80	146 x 196 x 96	1520 S	1520 P	-	
BC-□□P-172711	170 x 270 x 110	6.69 x 10.63 x 4.33	30	80	146 x 246 x 96	1525 S	1525 P	-	
BC-□□P-212110	210 x 210 x 100	8.27 x 8.27 x 3.94	25	75	185 x 185 x 87	2020 S	2020 P	-	
BC-□□P-212113	210 x 210 x 130	8.27 x 8.27 x 5.12	25	105	185 x 185 x 117	2020 S	2020 P	-	
BC-□□P-192810	190 x 280 x 100	7.48 x 11.02 x 3.94	30	70	165 x 255 x 84	1928 S	1928 P	1928 G	
BC-□□P-192814	190 x 280 x 140	7.48 x 11.02 x 5.51	30	110	165 x 255 x 124	1928 S	1928 P	1928 G	
BC-□□P-203013	200 x 300 x 130	7.87 x 11.81 x 5.12	30	100	175 x 275 x 114	2030 S	2030 P	-	
BC-□□P-203015	200 x 300 x 150	7.87 x 11.81 x 5.91	30	120	174 x 274 x 134	2030 S	2030 P	-	
BC-□□P-203018	200 x 300 x 180	7.87 x 11.81 x 7.09	30	150	173 x 273 x 164	2030 S	2030 P	-	
BC-□□P-253515	250 x 350 x 150	9.84 x 13.78 x 5.91	30	120	224 x 324 x 134	2535 S	2535 P	-	
BC-□□P-253518	250 x 350 x 180	9.84 x 13.78 x 7.09	30	150	223 x 323 x 164	2535 S	2535 P	-	
BC-□□P-282813	280 x 280 x 130	11.02 x 11.02 x 5.12	30	100	255 x 255 x 114	2828 S	2828 P	-	
BC-□□P-283813	280 x 380 x 130	11.02 x 14.96 x 5.12	30	100	255 x 355 x 114	2838 S	2838 P	-	
BC-□□P-303015	300 x 300 x 150	11.81 x 11.81 x 5.91	30	120	274 x 274 x 134	3030 S	3030 P	-	
BC-□□P-303018	300 x 300 x 180	11.81 x 11.81 x 7.09	30	150	273 x 273 x 164	3030 S	3030 P	-	
BC-□□P-304012	300 x 400 x 120	11.81 x 15.75 x 4.72	30	90	275 x 375 x 104	3040 S	3040 P	-	
BC-□□P-304015	300 x 400 x 150	11.81 x 15.75 x 5.91	30	120	274 x 374 x 134	3040 S	3040 P	-	
BC-□□P-304018	300 x 400 x 180	11.81 x 15.75 x 7.09	30	150	273 x 373 x 164	3040 S	3040 P	-	
BC-□□P-353515	350 x 350 x 150	13.78 x 13.78 x 5.91	30	120	324 x 324 x 134	3535 S	3535 P	-	
BC-□□P-353518	350 x 350 x 180	13.78 x 13.78 x 7.09	30	150	323 x 323 x 164	3535 S	3535 P	-	
BC-□□P-354512	350 x 450 x 120	13.78 x 17.72 x 4.72	30	90	318 x 418 x 103	3545 S	3545 P	-	
BC-□□P-354516	350 x 450 x 160	13.78 x 17.72 x 6.30	30	130	317 x 417 x 143	3545 S	3545 P	-	
BC-□□P-354520	350 x 450 x 200	13.78 x 17.72 x 7.87	30	170	316 x 416 x 183	3545 S	3545 P	-	
BC-□□P-405016	400 x 500 x 160	15.75 x 19.69 x 6.30	30	130	363 x 469 x 144	4050 S	4050 P	-	
BC-□□P-405020	400 x 500 x 200	15.75 x 19.69 x 7.87	30	170	361 x 468 x 184	4050 S	4050 P	-	
BC-□□P-406018	400 x 600 x 180	15.75 x 23.62 x 7.09	30	150	360 x 567 x 163	4060 S	4060 P	-	
BC-□□P-406023	400 x 600 x 230	15.75 x 23.62 x 9.06	30	200	360 x 568 x 213	4060 S	4060 P	-	
BC-□□P-506018	530 x 630 x 185	20.87 x 24.80 x 7.28	35	150	478 x 585 x 166	5060 S	5060 P	-	
BC-□□P-506025	530 x 630 x 255	20.87 x 24.80 x 10.04	35	220	476 x 576 x 236	5060 S	5060 P	-	
BC-□□P-507018	530 x 730 x 185	20.87 x 28.74 x 7.28	35	150	478 x 680 x 166	5070 S	5070 P	-	
BC-□□P-507025	530 x 730 x 255	20.87 x 28.74 x 10.04	35	220	476 x 676 x 236	5070 S	5070 P	-	
BC-□□P-608018	630 x 830 x 185	24.80 x 32.68 x 7.28	35	150	578 x 778 x 166	6080 S	-	-	
BC-□□P-608028	630 x 830 x 285	24.80 x 32.68 x 11.22	35	250	574 x 774 x 266	6080 S	-	-	

ACCESSORIES | 액세서리 | 配件



[Steel mounting plate]



[Plastic mounting plate]



[Key ring(K40)]



[Lock(SK)]

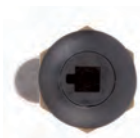

[Plastic lock(PK)]



[Integral lock(PSK15, PPK20, PPK35, PPK50)]



[SUS bracket(B40, B50, B60)]

B40 : P-091207~P-212113 (Screw : TTS 4x10)
 B50 : P-192810~P-406023 (Screw : TH M5x10)
 B60 : P-406018~P-608028
 (Screw : TH M5x10, TH M6x10)



[Plastic bracket(PB40, PB50)]

PB40 : P-091207~P-212113 (Screw : TTS 4x12)
 PB50 : P-192810~P-507025 (Screw : TH M5x12)



[Vent(V60, V80)]

DUAL DOOR | 이중도어 | 双层门

INDUSTRIAL AUTOMATION

※ See page 53 of photo, description / 53 페이지 사진, 설명 참조 / 请查看53页图片和说明

Dual door applicable model / 이중도어 적용가능 제품 / 适用产品			Product model / 제품모델 / 产品型号		
Model 모델 / 型号	Size (W1xL1xH1/mm)	Size (W1xL1xH1/inch)	Dual door 이중도어 / 双层门系列	Dual door mounting plate 중판 / 内板	Dual door set 이중도어 세트 / 层门用配件
BC- □□P- 203013	200 x 300 x 130	7.87 x 11.81 x 5.12	BC- F203013	BC- FA2030	BC- FA203013
BC- □□P- 203015	200 x 300 x 150	7.87 x 11.81 x 5.91	BC- F203015	BC- FA2030	BC- FA203015
BC- □□P- 203018	200 x 300 x 180	7.87 x 11.81 x 7.09	BC- F203018	BC- FA2030	BC- FA203018
BC- □□P- 253515	250 x 350 x 150	9.84 x 13.78 x 5.91	BC- F253515	BC- FA2535	BC- FA253515
BC- □□P- 253518	250 x 350 x 180	9.84 x 13.78 x 7.09	BC- F253518	BC- FA2535	BC- FA253518
BC- □□P- 282813	280 x 280 x 130	11.02 x 11.02 x 5.12	BC- F282813	BC- FA2828	BC- FA282813
BC- □□P- 283813	280 x 380 x 130	11.02 x 14.96 x 5.12	BC- F283813	BC- FA2838	BC- FA283813
BC- □□P- 303015	300 x 300 x 150	11.81 x 11.81 x 5.91	BC- F303015	BC- FA3030	BC- FA303015
BC- □□P- 303018	300 x 300 x 180	11.81 x 11.81 x 7.09	BC- F303018	BC- FA3030	BC- FA303018
BC- □□P- 304015	300 x 400 x 150	11.81 x 15.75 x 5.91	BC- F304015	BC- FA3040	BC- FA304015
BC- □□P- 304018	300 x 400 x 180	11.81 x 15.75 x 7.09	BC- F304018	BC- FA3040	BC- FA304018
BC- □□P- 354516	350 x 450 x 160	13.78 x 17.72 x 6.30	BC- F354516	BC- FA3545	BC- FA354516
BC- □□P- 354520	350 x 450 x 200	13.78 x 17.72 x 7.87	BC- F354520	BC- FA3545	BC- FA354520
BC- □□P- 405016	400 x 500 x 160	15.75 x 19.69 x 6.30	BC- F405016	BC- FA4050	BC- FA405016
BC- □□P- 405020	400 x 500 x 200	15.75 x 19.69 x 7.87	BC- F405020	BC- FA4050	BC- FA405020
BC- □□P- 406018	400 x 600 x 180	15.75 x 23.62 x 7.09	BC- F406018	BC- FA4060	BC- FA406018
BC- □□P- 406023	400 x 600 x 230	15.75 x 23.62 x 9.06	BC- F406023	BC- FA4060	BC- FA406023
BC- □□P- 506018	530 x 630 x 185	20.87 x 24.80 x 7.28	BC- F506018	BC- FA5060	BC- FA506018
BC- □□P- 506025	530 x 630 x 255	20.87 x 24.80 x 10.04	BC- F506025	BC- FA5060	BC- FA506025

D Series

일체형 이중도어
一体型双层门



COVER

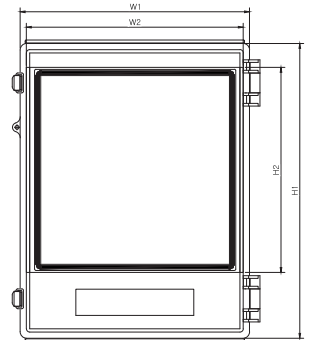

COVER + BASE

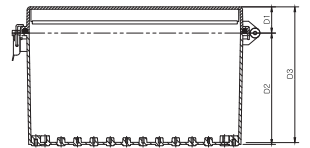

INDUSTRIAL AUTOMATION

FEATURE | 특성 | 特征

- It is easy to separate cover and base so that user can assemble them for processing and printing.
- Hinge is integrated with enclosure and main parts of draw latch are made of stainless steel to be solid and hinge connecting pins and draw latch are made of stainless steel and plastic to prevent rust.
- It is easy to control the internal facilities through the transparent window.
- 커버와 베이스의 분리가 용이하여 가공 및 인쇄작업 시 사용자가 쉽게 탈부착이 가능토록 제작하였습니다.
- 제품에 힌지를 일체형으로 성형하였으며, 힌지 연결핀과 매미고리 중요부위를 스텐레스로 제작하여 매우 견고하며 부식이 거의 없습니다.
- 투명 이중창을 통해 내부 설비를 쉽게 컨트롤 가능합니다.
- 盒体和盒盖分开设计，便于加工和印刷。
- 铰链及铰链的连接片及其他重要部件都采用不锈钢材质，不易生锈，非常牢固。
- 双层门系列产品可保护中门上安装的附件，外门打开方便操作

Product model 제품모델 / 产品型号		Outside dimension 외부 치수 / 外部尺寸		Mounting plate 속판모델 / 底板型号		Dual door plate 이중도어용 속판 / 双层门底板	
ABS	PC	Size (W1xL1xH1/mm)	Size (W1xL1xH1/inch)	Steel 철 / 金属	Plastic 플라스틱 / 塑料		Model No.
					G-type 사각형홀	C-type 체크형	
BC- ARD- 253517	BC-CRD- 253517	250 x 350 x 170	9.84 x 13.78 x 6.69	2535 SQ	2535 G	2535 C	D 2535
BC- ARD- 253519	BC-CRD- 253519	250 x 350 x 190	9.84 x 13.78 x 7.48	2535 SQ	2535 G	2535 C	D 2535
BC- AGD- 354513	BC- CGD- 354513	350 x 450 x 130	13.78 x 17.72 x 5.12	3545 S	3545 P		D 3545
BC- AGD- 354517	BC- CGD- 354517	350 x 450 x 170	13.78 x 17.72 x 6.69	3545 S	3545 P		D 3545
BC- AGD- 354521	BC- CGD- 354521	350 x 450 x 210	13.78 x 17.72 x 8.27	3545 S	3545 P		D 3545

UH Series

UH 시리즈 UH 系列

FEATURE | 특성 | 特征

- SUS hinge, SUS latch type
- 스텐레스 힌지, 스텐레스 래치 타입
- SUS铰链, 采用SUS锁扣

SPECIFICATION | 사양 | 产品规格说明

- Temperature Range / 온도영역 / 温度范围 | ABS : - 40 ~ + 70, PC : - 40 ~ + 110
- Flammability Rating / 난연성 / 阻燃等级 | ABS : 94-HB, PC : 94-V-0, 5VA, HB

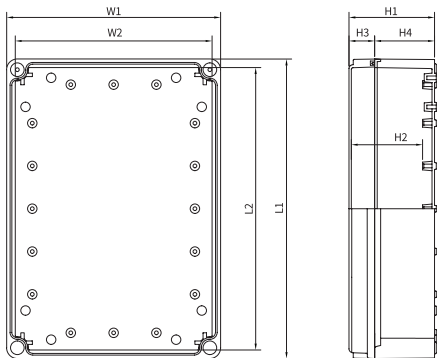

UH SERIES model name | UH 시리즈 모델선정방법 | UH 系列 产品型号命名方法

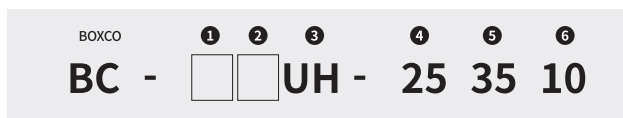

- ① Material / 재료 / 材质 - A : ABS C : PC
- ② Cover / 커버색상 / 箱盖颜色 - G : Grey / 회색 / 灰色 T : Transparent / 투명 / 透明
- ③ Type / 타입 / 类型 - SUS Hinge, SUS Latch / SUS힌지, SUS래치 / SUS铰链, SUS锁扣
- ④ Width / 가로 / 宽度(W)
- ⑤ Length / 세로 / 长度(L) - Hinge, Latch Installed / 힌지, 래치부착면 / 铰链, 锁扣安装面
- ⑥ Height / 높이 / 高度(H) - Cover Included / 커버포함 / 含箱盖



Model 모델 / 型号	Product model / 제품모델 / 产品型号				Mounting plate / 속판모델 / 底板型号				
	Outside dimension 외부 치수 / 外部尺寸				Inside dimension 내부 치수 / 内部尺寸		Steel 철 / 金属	Plastic 플라스틱 / 塑料	
	Size (W1xL1xH1/mm)	Size (W1xL1xH1/inch)	Cover (H3)	Base (H4)	Size (W2xL2xH2/mm)	G-type 사각형홀		C-type 체크형	
BC- □□UH- 253510	250 x 350 x 100	9.84x13.78x3.94	30	70	227 x 327 x 83	2535 SQ	2535 G	2535 C	
NEW BC- □□UH- 352510	350 x 250 x 100	13.78x9.84x3.94	30	70	327 x 227 x 83	2535 SQ	2535 G	2535 C	

ACCESSORIES | 액세서리 | 配件



H Series

H 시리즈 H 系列

FEATURE | 특성 | 特征

- SUS hinge, SUS latch and insert
- 스텐레스 힌지, 스텐레스 래치 타입, 인서트 있는 제품
- SUS铰链, 采用SUS锁扣 螺母的产品

SPECIFICATION | 사양 | 产品规格说明

- IP Rating / 방수, 방진 보호등급 / 防尘防水等级 | IP66/67
- IK Rating / 충격 테스트 / 冲击测试 | IK08
- Temperature Range / 온도영역 / 温度范围 | ABS : - 40 ~ + 70, PC : - 40 ~ + 110
- Flammability Rating / 난연성 / 阻燃等级 | ABS : 94-HB, PC : 94-V-0, 5VA, HB
- Certification / 인증 / 认证 | TUV, CE, UL (See page 6 / 6 페이지 참조 / 请参照第6页)

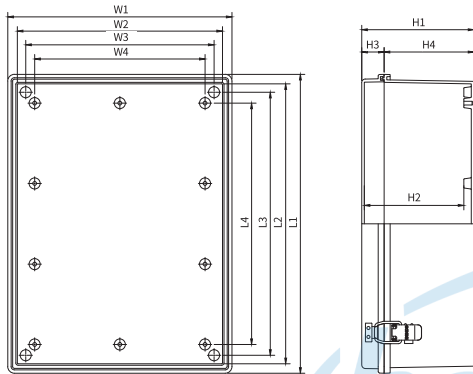

H SERIES model name | H 시리즈 모델선정방법 | H 系列 产品型号命名方法

BOXCO ① ② ③ ④ ⑤ ⑥

BC - [] [] H - 08 11 07

- ① Material / 재료 / 材质 - A : ABS C : PC
- ② Cover / 커버색상 / 箱盖颜色 - G : Grey / 회색 / 灰色 T : Transparent / 투명 / 透明
- ③ Type / 타입 / 类型 - SUS Hinge, SUS Latch / SUS힌지, SUS래치 / SUS铰链, SUS锁扣
- ④ Width / 가로 / 宽度(W)
- ⑤ Length / 세로 / 长度(L) - Hinge, Latch Installed / 힌지, 래치부착면 / 铰链, 锁扣安装面
- ⑥ Height / 높이 / 高度(H) - Cover Included / 커버포함 / 含箱盖



S Design / S 디자인 / S 设计
80x110x70 ~ 230x210x100mm



M Design / M 디자인 / M 设计
190x190x130 ~ 560x380x180mm



L Design / L 디자인 / L 设计
225x275x120 ~ 600x400x230mm



Examples of use / 고객사용예 / 使用实例



H Series - S Design | S 디자인 | S 设计
80x110x70 ~ 230x210x100mm

Product model / 제품모델 / 产品型号						Mounting plate / 속판모델 / 底板型号	
Model 모델 / 型号	Outside dimension 외부 치수 / 外部尺寸				Inside dimension 내부 치수 / 内部尺寸	Steel 철 / 金属	Plastic 플라스틱 / 塑料
	Size (W1xL1xH1/mm)	Size (W1xL1xH1/inch)	Cover (H3)	Base (H4)	Size (W2xL2xH2/mm)		
BC- □□H- 081107	80 x 110 x 70	3.15 x 4.33 x 2.76	20	50	70 x 100 x 57	0811 S	0811 P
BC- □□H- 110807	110 x 80 x 70	4.33 x 3.15 x 2.76	20	50	100 x 70 x 57	0811 S	0811 P
BC- □□H- 081108	80 x 110 x 85	3.15 x 4.33 x 3.35	20	65	70 x 100 x 72	0811 S	0811 P
BC- □□H- 110808	110 x 80 x 85	4.33 x 3.15 x 3.35	20	65	100 x 70 x 72	0811 S	0811 P
BC- □□H- 081110	80 x 110 x 100	3.15 x 4.33 x 3.94	35	65	70 x 100 x 87	0811 S	0811 P
BC- □□H- 110810	110 x 80 x 100	4.33 x 3.15 x 3.94	35	65	100 x 70 x 87	0811 S	0811 P
BC- □□H- 081307	80 x 130 x 70	3.15 x 5.12 x 2.76	20	50	70 x 120 x 57	0813 S	0813 P
BC- □□H- 130807	130 x 80 x 70	5.12 x 3.15 x 2.76	20	50	120 x 70 x 57	0813 S	0813 P
BC- □□H- 081308	80 x 130 x 85	3.15 x 5.12 x 3.35	35	50	70 x 120 x 72	0813 S	0813 P
BC- □□H- 130808	130 x 80 x 85	5.12 x 3.15 x 3.35	35	50	120 x 70 x 72	0813 S	0813 P
BC- □□H- 081807	80 x 180 x 70	3.15 x 7.09 x 2.76	20	50	70 x 170 x 57	0818 S	0818 P
BC- □□H- 180807	180 x 80 x 70	7.09 x 3.15 x 2.76	20	50	170 x 70 x 57	0818 S	0818 P
BC- □□H- 081808	80 x 180 x 85	3.15 x 7.09 x 3.35	35	50	70 x 170 x 72	0818 S	0818 P
BC- □□H- 180808	180 x 80 x 85	7.09 x 3.15 x 3.35	35	50	170 x 70 x 72	0818 S	0818 P
NEW BC- □□H- 082007	80 x 200 x 70	3.15 x 7.87 x 2.76	20	50	67 x 189 x 56	0820 S	-
NEW BC- □□H- 200807	200 x 80 x 70	7.87 x 3.15 x 2.76	20	50	189 x 67 x 56	0820 S	-
BC- □□H- 082507	80 x 250 x 70	3.15 x 9.84 x 2.76	20	50	67 x 235 x 57	0825 S	0825 P
BC- □□H- 250807	250 x 80 x 70	9.84 x 3.15 x 2.76	20	50	235 x 67 x 57	0825 S	0825 P
BC- □□H- 082508	80 x 250 x 85	3.15 x 9.84 x 3.35	35	50	67 x 235 x 72	0825 S	0825 P
BC- □□H- 250808	250 x 80 x 85	9.84 x 3.15 x 3.35	35	50	235 x 67 x 72	0825 S	0825 P
BC- □□H- 101007	100 x 100 x 75	3.94 x 3.94 x 2.95	20	55	88 x 88 x 62	1010 S	1010 P
BC- □□H- 101010	100 x 100 x 100	3.94 x 3.94 x 3.94	20	80	88 x 88 x 87	1010 S	1010 P
BC- □□H- 121207	125 x 125 x 75	4.92 x 4.92 x 2.95	20	55	113 x 113 x 61	1212 S	1212 P
BC- □□H- 121210	125 x 125 x 100	4.92 x 4.92 x 3.94	20	80	113 x 113 x 86	1212 S	1212 P
BC- □□H- 121707	125 x 175 x 75	4.92 x 6.89 x 2.95	25	49	117 x 165 x 61	1217 S	1217 P
BC- □□H- 171207	175 x 125 x 75	6.89 x 4.92 x 2.95	25	49	165 x 117 x 61	1217 S	1217 P
BC- □□H- 121710	125 x 175 x 100	4.92 x 6.89 x 3.94	50	49	117 x 165 x 86	1217 S	1217 P
BC- □□H- 171210	175 x 125 x 100	6.89 x 4.92 x 3.94	50	49	165 x 117 x 86	1217 S	1217 P
BC- □□H- 141709	140 x 170 x 95	5.51 x 6.69 x 3.74	20	75	130 x 159 x 82	1417 S	1417 P
BC- □□H- 171409	170 x 140 x 95	6.69 x 5.51 x 3.74	20	75	159 x 130 x 82	1417 S	1417 P
BC- □□H- 142309	140 x 230 x 95	5.51 x 9.06 x 3.74	20	75	128 x 218 x 82	1423 S	1423 P
BC- □□H- 231409	230 x 140 x 95	9.06 x 5.51 x 3.74	20	75	219 x 130 x 82	1423 S	1423 P
BC- □□H- 151507	150 x 150 x 75	5.91 x 5.91 x 2.95	20	55	138 x 138 x 62	1515 S	1515 P
BC- □□H- 151510	150 x 150 x 100	5.91 x 5.91 x 3.94	20	80	138 x 138 x 87	1515 S	1515 P
BC- □□H- 152007	150 x 200 x 75	5.91 x 7.87 x 2.95	20	55	138 x 188 x 62	1520 S	1520 P
BC- □□H- 201507	200 x 150 x 75	7.87 x 5.91 x 2.95	20	55	188 x 138 x 62	1520 S	1520 P
BC- □□H- 152010	150 x 200 x 100	5.91 x 7.87 x 3.94	20	79	138 x 188 x 86	1520 S	1520 P
BC- □□H- 201510	200 x 150 x 100	7.87 x 5.91 x 3.94	20	79	188 x 138 x 87	1520 S	1520 P
BC- □□H- 152013	150 x 200 x 130	5.91 x 7.87 x 5.12	20	110	138 x 188 x 117	1520 S	1520 P
BC- □□H- 201513	200 x 150 x 130	7.87 x 5.91 x 5.12	20	110	188 x 138 x 117	1520 S	1520 P
BC- □□H- 152016	150 x 200 x 160	5.91 x 7.87 x 6.30	50	110	138 x 188 x 146	1520 S	1520 P
BC- □□H- 201516	200 x 150 x 160	7.87 x 5.91 x 6.30	50	110	188 x 138 x 146	1520 S	1520 P
BC- □□H- 152510	150 x 250 x 100	5.91 x 9.84 x 3.94	20	80	140 x 240 x 87	1525 S	1525 P
BC- □□H- 251510	250 x 150 x 100	9.84 x 5.91 x 3.94	20	80	240 x 140 x 87	1525 S	1525 P
BC- □□H- 152513	150 x 250 x 130	5.91 x 9.84 x 5.12	50	80	140 x 240 x 117	1525 S	1525 P
BC- □□H- 251513	250 x 150 x 130	9.84 x 5.91 x 5.12	50	80	240 x 140 x 117	1525 S	1525 P

BC- □□H- 202010	200 x 200 x 100	7.87 x 7.87 x 3.94	20	80	188 x 188 x 87	2020 S	2020 P
BC- □□H- 202013	200 x 200 x 130	7.87 x 7.87 x 5.12	20	110	188 x 188 x 117	2020 S	2020 P
BC- □□H- 202016	200 x 200 x 160	7.87 x 7.87 x 6.30	20	140	188 x 188 x 147	2020 S	2020 P
BC- □□H- 202019	200 x 200 x 190	7.87 x 7.87 x 7.48	50	140	188 x 188 x 177	2020 S	2020 P
BC- □□H- 212310	210 x 230 x 100	8.27 x 9.06 x 3.94	20	80	197 x 217 x 87	2123 S	-
BC- □□H- 232110	230 x 210 x 100	9.06 x 8.27 x 3.94	20	80	217 x 197 x 87	2123 S	-

ACCESSORIES | 액세서리 | 配件



[Steel mounting plate]



[Plastic mounting plate]



[Key ring (K40)]



[Lock (SK)]



[Plastic lock (PK)]



[SUS bracket (B40)]
B40 : (Screw : TTS 5x10)



[Plastic bracket (PB40)]
PB40 : (Screw : TTS 5x12)



[Vent (V60, V80)]

INDUSTRIAL AUTOMATION





H Series - M Design | M 디자인 | M 设计
190x190x130 ~ 560x380x180mm

Model 모델 / 型号	Product model / 제품모델 / 产品型号				Mounting plate / 속판모델 / 底板型号				
	Outside dimension 외부 치수 / 外部尺寸				Inside dimension 내부 치수 / 内部尺寸		Steel 철 / 金属	Plastic 플라스틱 / 塑料	
	Size (W1xL1xH1/mm)	Size (W1xL1xH1/inch)	Cover (H3)	Base (H4)	Size (W2xL2xH2/mm)	P-type		G-type	
BC- □□H- 191913	190 x 190 x 130	7.48 x 7.48 x 5.12	30	98	165 x 165 x 114	1919 S	1919 P	-	
BC- □□H- 192810	190 x 280 x 100	7.48 x 11.02 x 3.94	30	68	165 x 255 x 84	1928 S	1928 P	1928 G	
BC- □□H- 281910	280 x 190 x 100	11.02 x 7.48 x 3.94	30	68	255 x 165 x 84	1928 S	1928 P	1928 G	
BC- □□H- 192813	190 x 280 x 130	7.48 x 11.02 x 5.12	30	98	165 x 256 x 114	1928 S	1928 P	1928 G	
BC- □□H- 281913	280 x 190 x 130	11.02 x 7.48 x 5.12	30	98	256 x 165 x 114	1928 S	1928 P	1928 G	
BC- □□H- 192818	190 x 280 x 180	7.48 x 11.02 x 7.09	30	148	163 x 254 x 164	1928 S	1928 P	1928 G	
BC- □□H- 281918	280 x 190 x 180	11.02 x 7.48 x 7.09	30	148	254 x 163 x 164	1928 S	1928 P	1928 G	
BC- □□H- 193813	190 x 380 x 130	7.48 x 14.96 x 5.12	30	98	165 x 355 x 114	1938 S	1938 P	-	
BC- □□H- 381913	380 x 190 x 130	14.96 x 7.48 x 5.12	30	98	355 x 165 x 114	1938 S	1938 P	-	
BC- □□H- 193818	190 x 380 x 180	7.48 x 14.96 x 7.09	30	148	165 x 355 x 164	1938 S	1938 P	-	
BC- □□H- 381918	380 x 190 x 180	14.96 x 7.48 x 7.09	30	148	355 x 165 x 164	1938 S	1938 P	-	
BC- □□H- 282813	280 x 280 x 130	11.02 x 11.02 x 5.12	30	100	255 x 255 x 114	2828 S	2828 P	-	
BC- □□H- 283413	280 x 340 x 130	11.02 x 13.39 x 5.12	30	98	256 x 314 x 112	2834 S	2834 P	-	
BC- □□H- 342813	340 x 280 x 130	13.39 x 11.02 x 5.12	30	98	314 x 256 x 112	2834 S	2834 P	-	
BC- □□H- 283813	280 x 380 x 130	11.02 x 14.96 x 5.12	30	98	255 x 355 x 112	2838 S	2838 P	-	
BC- □□H- 382813	380 x 280 x 130	14.96 x 11.02 x 5.12	30	98	355 x 255 x 112	2838 S	2838 P	-	
BC- □□H- 283818	280 x 380 x 180	11.02 x 14.96 x 7.09	30	148	255 x 355 x 162	2838 S	2838 P	-	
BC- □□H- 382818	380 x 280 x 180	14.96 x 11.02 x 7.09	30	148	355 x 255 x 162	2838 S	2838 P	-	
BC- □□H- 285613	280 x 560 x 130	11.02 x 22.05 x 5.12	30	98	255 x 535 x 112	2856 S	-	-	
BC- □□H- 562813	560 x 280 x 130	22.05 x 11.02 x 5.12	30	98	535 x 255 x 112	2856 S	-	-	
BC- □□H- 334318	330 x 430 x 180	12.99 x 16.93 x 7.09	30	148	305 x 405 x 160	3343 S	3343 P	-	
BC- □□H- 433318	430 x 330 x 180	16.93 x 12.99 x 7.09	30	148	405 x 305 x 164	3343 S	3343 P	-	
BC- □□H- 385618	380 x 560 x 180	14.96 x 22.05 x 7.09	30	148	355 x 535 x 160	3856 S	-	-	
BC- □□H- 563818	560 x 380 x 180	22.05 x 14.96 x 7.09	30	148	535 x 355 x 160	3856 S	-	-	

※ BC- □□H-563818 is for non water proof product. / BC- □□H-563818은 비방수용입니다. / BC- □□H-563818是非防水用的型号.

ACCESSORIES | 액세서리 | 配件



[Steel mounting plate]



[Plastic mounting plate]



[Key ring(K40)]



[Lock(SK)]



[Plastic lock(PK)]



[SUS bracket(B50)]

B50 : (Screw : TH M5x10)



[Plastic bracket(PB50)]

PB50 : (Screw : TH M5x12)



[Vent(V60, V80)]

H Series - L Design | L 디자인 | L 设计
225x275x120 ~ 600x400x230mm



Product model / 제품모델 / 产品型号						Mounting plate / 속판모델 / 底板型号		
Model 모델 / 型号	Outside dimension 외부 치수 / 外部尺寸				Inside dimension 내부 치수 / 内部尺寸		Steel 철 / 金属	Plastic 플라스틱 / 塑料
	Size (W1xL1xH1/mm)	Size (W1xL1xH1/inch)	Cover (H3)	Base (H4)	Size (W2xL2xH2/mm)			
BC- □□H- 222712	225 x 275 x 120	8.86 x 10.83 x 4.72	30	90	201 x 252 x 104		2227 S	2227 P
BC- □□H- 272212	275 x 225 x 120	10.83 x 8.86 x 4.72	30	90	252 x 201 x 104		2227 S	2227 P
BC- □□H- 203015	200 x 300 x 150	7.87 x 11.81 x 5.91	30	122	174 x 274 x 136		2030 S	2030 P
BC- □□H- 302015	300 x 200 x 150	11.81 x 7.87 x 5.91	30	122	274 x 174 x 136		2030 S	2030 P
BC- □□H- 203018	200 x 300 x 180	7.87 x 11.81 x 7.09	30	150	175 x 275 x 164		2030 S	2030 P
BC- □□H- 302018	300 x 200 x 180	11.81 x 7.87 x 7.09	30	150	275 x 175 x 164		2030 S	2030 P
BC- □□H- 253515	250 x 350 x 150	9.84 x 13.78 x 5.91	30	120	223 x 324 x 134		2535 S	2535 P
BC- □□H- 352515	350 x 250 x 150	13.78 x 9.84 x 5.91	30	120	324 x 223 x 134		2535 S	2535 P
BC- □□H- 304015	300 x 400 x 150	11.81 x 15.75 x 5.91	30	120	274 x 374 x 136		3040 S	3040 P
BC- □□H- 403015	400 x 300 x 150	15.75 x 11.81 x 5.91	30	120	374 x 274 x 136		3040 S	3040 P
BC- □□H- 304018	300 x 400 x 180	11.81 x 15.75 x 7.09	30	150	274 x 375 x 164		3040 S	3040 P
BC- □□H- 403018	400 x 300 x 180	15.75 x 11.81 x 7.09	30	150	375 x 274 x 164		3040 S	3040 P
BC- □□H- 354516	350 x 450 x 160	13.78 x 17.72 x 6.30	30	130	311 x 417 x 143		3545 S	3545 P
BC- □□H- 453516	450 x 350 x 160	17.72 x 13.78 x 6.30	30	130	417 x 311 x 143		3545 S	3545 P
BC- □□H- 354520	350 x 450 x 200	13.78 x 17.72 x 7.87	30	170	320 x 420 x 178		3545 S	3545 P
BC- □□H- 453520	450 x 350 x 200	17.72 x 13.78 x 7.87	30	170	420 x 320 x 178		3545 S	3545 P
BC- □□H- 405020	400 x 500 x 200	15.75 x 19.69 x 7.87	30	170	363 x 469 x 186		4050 S	4050 P
BC- □□H- 504020	500 x 400 x 200	19.69 x 15.75 x 7.87	30	170	469 x 363 x 186		4050 S	4050 P
BC- □□H- 406023	400 x 600 x 230	15.75 x 23.62 x 9.06	30	200	375 x 575 x 216		4060 S	4060 P
BC- □□H- 604023	600 x 400 x 230	23.62 x 15.75 x 9.06	30	200	575 x 375 x 216		4060 S	4060 P

※ BC- □□H-604023 is for non water proof product. / BC- □□H-604023은 비방수용입니다. / BC- □□H-604023是非防水用的型号.

ACCESSORIES | 액세서리 | 配件

INDUSTRIAL AUTOMATION



[Steel mounting plate]



[Plastic mounting plate]



[Key ring(K40)]



[Lock(SK)]



[Plastic lock(PK)]



[SUS bracket(B50, B60)]
B50 : (Screw : TH M5x10)
B60 : (Screw : TH M5x10)



[Plastic bracket(PB50)]
PB50 : (Screw : TH M5x12)



[Vent(V60, V80)]

DUAL DOOR | 이중도어 | 双层门

※ See page 53 of photo, description / 53 페이지 사진, 설명 참조 / 请查看53页图片和说明

Dual door applicable model / 이중도어 적용가능 제품 / 适用产品		Product model / 제품모델 / 产品型号		
Model 모델 / 型号	Size (WxLxH/mm)	Dual door 이중도어 / 双层门系列	Dual door mounting plate 중판 / 内板	Dual door set 层门用配件
BC- □□H- 405020	400 x 500 x 200	BC- F405020	BC- FA4050	BC- FA405020
BC- □□H- 406023	400 x 600 x 230	BC- F406023	BC- FA4060	BC- FA406023

M Series

M 시리즈
M 系列

80x130x35 ~ 180x255x125mm

FEATURE | 특성 | 特征

- Screw type with recessed cover
- For mounting membrane keypad
- 스크류 타입
- 멤브레인 키패드 부착용
- 螺栓型, 凹型盒盖
- 粘贴薄膜触摸键盘

SPECIFICATION | 사양 | 产品规格说明

- IP Rating / 방수, 방진 보호등급 / 防尘防水等级 | IP66/67
- IK Rating / 충격 테스트 / 冲击测试 | IK08
- Temperature Range / 온도영역 / 温度范围 | ABS : - 40 ~ + 70, PC : - 40 ~ + 110
- Flammability Rating / 난연성 / 阻燃等级 | ABS : 94-HB, PC : 94-V-0, 5VA, HB
- Certification / 인증 / 认证 | TUV, CE, UL (See page 6 / 6 페이지 참조 / 请参照第6页)

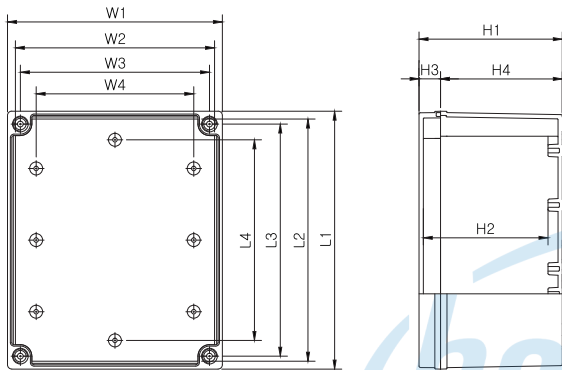

M SERIES model name | M 시리즈 모델선정방법 | M 系列 产品型号命名方法

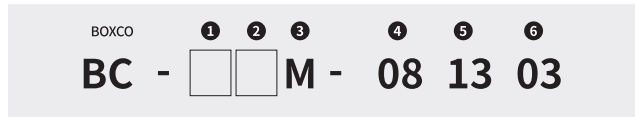

- ① Material / 재료 / 材质 - A : ABS C : PC
- ② Cover / 커버색상 / 箱盖颜色 - G : Grey / 회색 / 灰色 T : Transparent / 투명 / 透明
- ③ Type / 타입 / 类型 - Screw Cover / 스크류커버 / 螺栓型
- ④ Width / 가로 / 宽度(W)
- ⑤ Length / 세로 / 长度(L)
- ⑥ Height / 높이 / 高度(H) - Cover Included / 커버포함 / 含箱盖



Product model / 제품모델 / 产品型号						Mounting plate / 속판모델 / 底板型号	
Model 모델 / 型号	Outside dimension 외부 치수 / 外部尺寸				Inside dimension 내부 치수 / 内部尺寸	Steel 철 / 金属	Plastic 플라스틱 / 塑料
	Size (W1xL1xH1/mm)	Size (W1xL1xH1/inch)	Cover (H3)	Base (H4)	Size (W2xL2xH2/mm)		
BC- □□M- 081303	80 x 130 x 35	3.15 x 5.12 x 1.38	10	25	68 x 118 x 24	0813 M	-
BC- □□M- 081306	80 x 130 x 60	3.15 x 5.12 x 2.36	10	50	68 x 118 x 47	0813 M	-
BC- □□M- 081307	80 x 130 x 75	3.15 x 5.12 x 2.95	10	65	68 x 118 x 62	0813 M	-
BC- □□M- 081308	80 x 130 x 85	3.15 x 5.12 x 3.35	35	50	68 x 118 x 72	0813 M	-
BC- □□M- 081310	80 x 130 x 100	3.15 x 5.12 x 3.94	10	90	68 x 118 x 87	0813 M	-
BC- □□M- 081312	80 x 130 x 125	3.15 x 5.12 x 4.92	35	90	68 x 118 x 112	0813 M	-
BC- □□M- 131303	130 x 130 x 35	5.12 x 5.12 x 1.38	10	25	119 x 119 x 24	1313 M	-
BC- □□M- 131306	130 x 130 x 60	5.12 x 5.12 x 2.36	10	50	119 x 119 x 47	1313 M	-
BC- □□M- 131803	130 x 180 x 35	5.12 x 7.09 x 1.38	10	25	119 x 169 x 24	1318 M	1217 P
BC- □□M- 131806	130 x 180 x 60	5.12 x 7.09 x 2.36	10	50	119 x 169 x 47	1318 M	1217 P
NEW BC- □□M- 131808	130 x 180 x 75	5.12 x 7.09 x 2.95	10	65	119 x 169 x 62	1318 M	1217 P
BC- □□M- 151806	150 x 180 x 60	5.91 x 7.09 x 2.36	10	50	142 x 172 x 47	1518 M	-
BC- □□M- 181806	180 x 180 x 60	7.09 x 7.09 x 2.36	10	50	169 x 169 x 47	1818 M	-
BC- □□M- 181807	180 x 180 x 75	7.09 x 7.09 x 2.95	10	65	169 x 169 x 62	1818 M	-
BC- □□M- 181810	180 x 180 x 100	7.09 x 7.09 x 3.94	10	90	169 x 169 x 87	1818 M	-
BC- □□M- 181812	180 x 180 x 125	7.09 x 7.09 x 4.92	10	115	169 x 169 x 112	1818 M	-
BC- □□M- 182507	180 x 255 x 75	7.09 x 10.04 x 2.95	15	60	169 x 244 x 62	1825 M	-
BC- □□M- 182510	180 x 255 x 100	7.09 x 10.04 x 3.94	15	85	169 x 244 x 87	1825 M	-
BC- □□M- 182512	180 x 255 x 125	7.09 x 10.04 x 4.92	15	110	169 x 244 x 112	1825 M	-

ACCESSORIES | 액세서리 | 配件



[Steel mounting plate]



[SUS bracket(B40)]
(Screw : TTS 5x10)



[Plastic bracket(PB40)]
(Screw : TTS 5x12)



[Cover screw(standard, CB10)]



[Cover screw(standard, CB35)]



U Series

U 시리즈 U 系列

FEATURE | 특성 | 特征

- Screw type
- 스크류 타입
- 螺栓型

SPECIFICATION | 사양 | 产品规格说明

- Temperature Range / 온도영역 / 温度范围 | ABS : - 40 ~ + 70, PC : - 40 ~ + 110
- Flammability Rating / 난연성 / 阻燃等级 | ABS : 94-HB, PC : 94-V-0, 5VA, HB

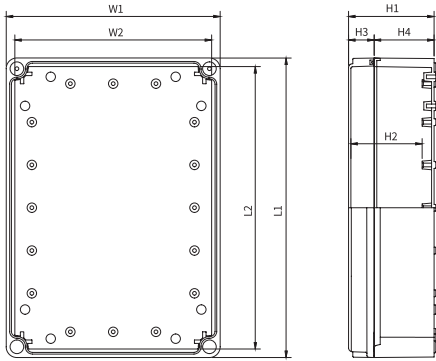

U SERIES model name | U 시리즈 모델선정방법 | U 系列 产品型号命名方法

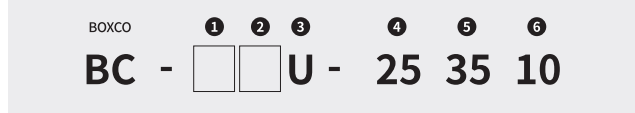

- ① Material / 재료 / 材质 - A : ABS C : PC
- ② Cover / 커버색상 / 箱盖颜色 - G : Grey / 회색 / 灰色 T : Transparent / 투명 / 透明
- ③ Type / 타입 / 类型 - Screw Cover / 스크류커버 / 螺栓型
- ④ Width / 가로 / 宽度(W)
- ⑤ Length / 세로 / 长度(L)
- ⑥ Height / 높이 / 高度(H) - Cover Included / 커버포함 / 含箱盖



Product model / 제품모델 / 产品型号					Mounting plate / 속판모델 / 底板型号				
Model 모델 / 型号	Outside dimension 외부 치수 / 外部尺寸				Inside dimension 내부 치수 / 内部尺寸		Steel 철 / 金属	Plastic 플라스틱 / 塑料	
	Size (W1xL1xH1/mm)	Size (W1xL1xH1/inch)	Cover (H3)	Base (H4)	Size (W2xL2xH2/mm)	G-type 사각형홀		C-type 체크형	
BC- [] [] U-253510	250 x 350 x 100	9.84 x 13.78 x 3.94	30	70	227 x 327 x 83	2535 SQ	2535 G	2535 C	

ACCESSORIES | 액세서리 | 配件



[SUS bracket(B50, 60)]
B50 (Screw : TTS 5x10)
B60 (Screw : TTS 5x10)



[Plastic bracket(PB50)]
PB50 : (Screw : TTS 5x12)



[Vent(V60, V80)]

S Series

S 시리즈
S 系列

FEATURE | 특성 | 特征

- Screw type, insert
- 스크류 타입, 인서트 있는 제품
- 螺栓型, 有螺母的产品

SPECIFICATION | 사양 | 产品规格说明

- IP Rating / 방수, 방진 보호등급 / 防尘防水等级 | IP66/67
- IK Rating / 충격 테스트 / 冲击测试 | IK08
- Temperature Range / 온도영역 / 温度范围 | ABS : - 40 ~ + 70, PC : - 40 ~ + 110
- Flammability Rating / 난연성 / 阻燃等级 | ABS : 94-HB, PC : 94-V-0, 5VA, HB
- Certification / 인증 / 认证 | TUV, CE, UL (See page 6 / 6 페이지 참조 / 请参考第6页)

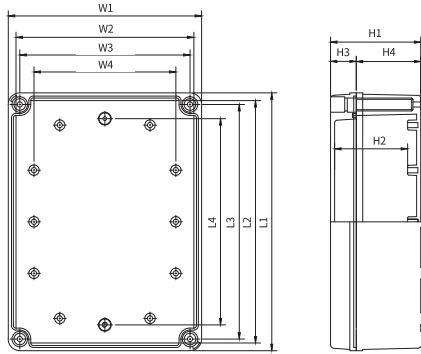

S SERIES model name | S 시리즈 모델선정방법 | S 系列产品型号命名方法

BOXCO ① ② ③ ④ ⑤ ⑥
BC - [] [] S - 19 19 13

- ① Material / 재료 / 材质 - A : ABS C : PC
- ② Cover / 커버색상 / 箱盖颜色 - G : Grey / 회색 / 灰色 T : Transparent / 투명 / 透明
- ③ Type / 타입 / 类型 - Screw Cover / 스크류 커버 / 螺栓型
- ④ Width / 가로 / 宽度(W)
- ⑤ Length / 세로 / 长度(L)
- ⑥ Height / 높이 / 高度(H) - Cover Included / 커버포함 / 含箱盖

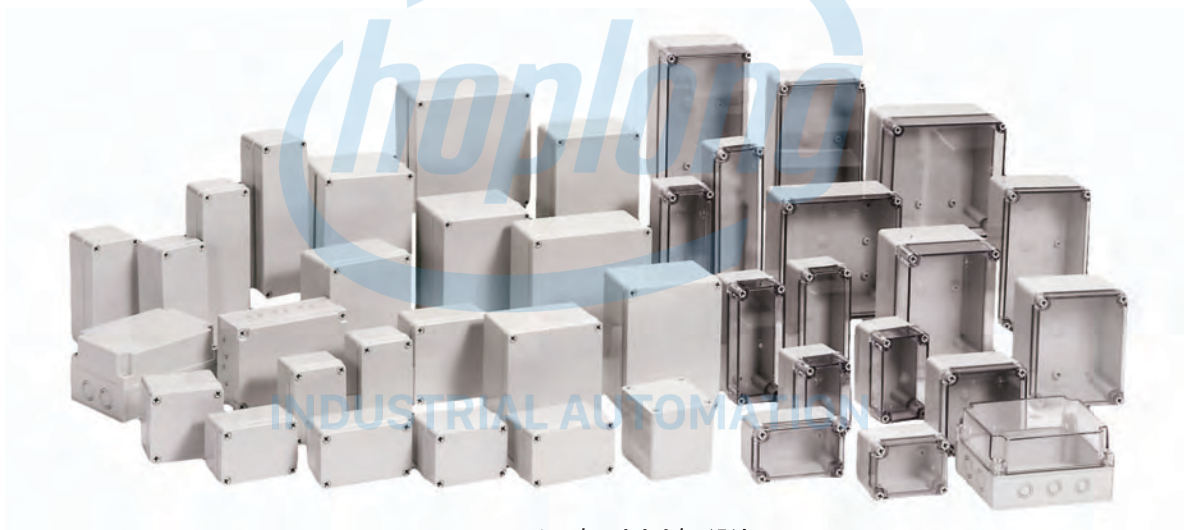

S Design / S 디자인 / S 设计
50x60x45 ~ 210x230x100mm



M Design / M 디자인 / M 设计
190x190x130 ~ 380x560x180mm



S Series - S Design | S 디자인 | S 设计
50x60x45 ~ 210x230x100mm

Product model / 제품모델 / 产品型号						Mounting plate / 속판모델 / 底板型号	
Model 모델 / 型号	Outside dimension 외부 치수 / 外部尺寸				Inside dimension 내부 치수 / 内部尺寸	Steel 철 / 金属	Plastic 플라스틱 / 塑料
	Size (W1xL1xH1/mm)	Size (W1xL1xH1/inch)	Cover (H3)	Base (H4)	Size (W2xL2xH2/mm)		
BC- □□S- 050604	50 x 65 x 45	1.97 x 2.56 x 1.77	15	30	42 x 57 x 33	0506 S	-
BC- □□S- 050605	50 x 65 x 55	1.97 x 2.56 x 2.17	15	40	42 x 57 x 43	0506 S	-
BC- □□S- 060905	65 x 95 x 55	2.56 x 3.74 x 2.17	15	40	55 x 85 x 41	0609 S	-
BC- □□S- 071005	75 x 105 x 55	2.95 x 4.13 x 2.17	15	40	65 x 95 x 42	0710 S	-
BC- □□S- 080806	80 x 80 x 60	3.15 x 3.15 x 2.36	15	45	70 x 70 x 47	0808 S	-
BC- □□S- 081104	80 x 110 x 45	3.15 x 4.33 x 1.77	20	25	70 x 100 x 32	0811 S	0811 P
BC- □□S- 081107	80 x 110 x 70	3.15 x 4.33 x 2.76	20	50	70 x 100 x 57	0811 S	0811 P
BC- □□S- 081108	80 x 110 x 85	3.15 x 4.33 x 3.35	20	65	70 x 100 x 72	0811 S	0811 P
BC- □□S- 081110	80 x 110 x 100	3.15 x 4.33 x 3.94	35	65	70 x 100 x 87	0811 S	0811 P
BC- □□S- 081307	80 x 130 x 70	3.15 x 5.12 x 2.76	20	50	70 x 120 x 57	0813 S	0813 P
BC- □□S- 081308	80 x 130 x 85	3.15 x 5.12 x 3.35	35	50	70 x 120 x 72	0813 S	0813 P
BC- □□S- 081605	82 x 162 x 55	3.23 x 6.38 x 2.17	15	40	75 x 155 x 42	0816 S	0816 P
BC- □□S- 081608	82 x 162 x 85	3.23 x 6.38 x 3.35	15	70	75 x 155 x 72	0816 S	0816 P
BC- □□S- 081807	80 x 180 x 70	3.15 x 7.09 x 2.76	20	50	69 x 169 x 57	0818 S	0818 P
BC- □□S- 081808	80 x 180 x 85	3.15 x 7.09 x 3.35	35	50	69 x 169 x 72	0818 S	0818 P
NEW BC- □□S- 082007	80 x 200 x 70	3.15 x 7.87 x 2.76	20	50	67 x 189 x 56	0820 S	-
BC- □□S- 082507	80 x 250 x 70	3.15 x 9.84 x 2.76	20	50	67 x 235 x 56	0825 S	0825 P
BC- □□S- 082508	80 x 250 x 85	3.15 x 9.84 x 3.35	35	50	67 x 235 x 72	0825 S	0825 P
BC- □□S- 101007	100 x 100 x 75	3.94 x 3.94 x 2.95	20	55	88 x 88 x 62	1010 S	1010 P
BC- □□S- 101010	100 x 100 x 100	3.94 x 3.94 x 3.94	20	80	88 x 88 x 87	1010 S	1010 P
BC- □□S- 101807	100 x 185 x 70	3.94 x 7.28 x 2.76	15	54	92 x 177 x 56	1018 S	-
BC- □□S- 102007	100 x 200 x 70	3.94 x 7.87 x 2.76	15	54	89 x 189 x 56	1020 S	1020 P
BC- □□S- 102307	100 x 230 x 70	3.94 x 9.06 x 2.76	15	54	89 x 219 x 56	1023 S	-
BC- □□S- 121207	125 x 125 x 75	4.92 x 4.92 x 2.95	20	55	114 x 114 x 61	1212 S	1212 P
BC- □□S- 121210	125 x 125 x 100	4.92 x 4.92 x 3.94	20	80	113 x 113 x 86	1212 S	1212 P
BC- □□S- 121707	125 x 175 x 75	4.92 x 6.89 x 2.95	25	49	118 x 165 x 61	1217 S	1217 P
BC- □□S- 121710	125 x 175 x 100	4.92 x 6.89 x 3.94	50	49	118 x 165 x 86	1217 S	1217 P
BC- □□S- 141709	140 x 170 x 95	5.51 x 6.69 x 3.74	20	75	135 x 165 x 82	1417 S	1417 P
BC- □□S- 142309	140 x 230 x 95	5.51 x 9.06 x 3.74	20	75	132 x 222 x 82	1423 S	1423 P
BC- □□S- 151507	150 x 150 x 75	5.91 x 5.91 x 2.95	20	55	144 x 144 x 62	1515 S	1515 P
BC- □□S- 151510	150 x 150 x 100	5.91 x 5.91 x 3.94	20	80	144 x 144 x 87	1515 S	1515 P
BC- □□S- 152004	150 x 200 x 45	5.91 x 7.87 x 1.77	20	25	140 x 190 x 32	1520 S	1520 P
BC- □□S- 152007	150 x 200 x 75	5.91 x 7.87 x 2.95	20	55	138 x 188 x 62	1520 S	1520 P
BC- □□S- 152010	150 x 200 x 100	5.91 x 7.87 x 3.94	20	79	138 x 188 x 86	1520 S	1520 P
BC- □□S- 152013	150 x 200 x 130	5.91 x 7.87 x 5.12	20	110	138 x 188 x 116	1520 S	1520 P
BC- □□S- 152016	150 x 200 x 160	5.91 x 7.87 x 6.30	50	110	138 x 188 x 146	1520 S	1520 P
BC- □□S- 152510	150 x 250 x 100	5.91 x 9.84 x 3.94	20	80	138 x 238 x 87	1525 S	1525 P
BC- □□S- 152513	150 x 250 x 130	5.91 x 9.84 x 5.12	50	80	140 x 240 x 117	1525 S	1525 P
BC- □□S- 161607	160 x 160 x 70	6.30 x 6.30 x 2.76	15	54	151 x 151 x 56	1616 S	1616 P
BC- □□S- 202010	200 x 200 x 100	7.87 x 7.87 x 3.94	20	80	188 x 188 x 87	2020 S	2020 P
BC- □□S- 202013	200 x 200 x 130	7.87 x 7.87 x 5.12	20	110	188 x 188 x 117	2020 S	2020 P
BC- □□S- 202016	200 x 200 x 160	7.87 x 7.87 x 6.30	20	140	188 x 188 x 147	2020 S	2020 P
BC- □□S- 202019	200 x 200 x 190	7.87 x 7.87 x 7.48	50	140	188 x 188 x 171	2020 S	2020 P
BC- □□S- 212310	210 x 230 x 100	8.27 x 9.06 x 3.94	20	80	197 x 217 x 87	2123 S	-

ACCESSORIES | 액세서리 | 配件



[Steel mounting plate]



[Plastic mounting plate]



[Cover screw(standard, CB20+)]



[Cover screw(optional, CB20-)]



[Cover screw(standard, CB35)]



[Cover screw(standard, CB50)]



[SUS bracket(B40)]
B40 : (Screw : TTS 5x10)



[Plastic bracket(PB40)]
PB40 : (Screw : TTS 5x12)



[Vent(V60, V80)]

S Series - M Design | M 디자인 | M 设计

190x190x130 ~ 380x560x180mm



Model 모델 / 型号	Product model / 제품모델 / 产品型号				Mounting plate / 속판모델 / 底板型号			
	Outside dimension 외부 치수 / 外部尺寸		Inside dimension 내부 치수 / 内部尺寸		Steel 철 / 金属	Plastic 플라스틱 / 塑料		
	Size (W1xL1xH1/mm)	Size (W1xL1xH1/inch)	Cover (H3)	Base (H4)		Size (W2xL2xH2/mm)	P-type	G-type
BC- □□S- 191913	190 x 190 x 130	7.48 x 7.48 x 5.12	30	98	165 x 165 x 114	1919 S	1919 P	-
BC- □□S- 192810	190 x 280 x 100	7.48 x 11.02 x 3.94	30	68	165 x 255 x 84	1928 S	1928 P	1928 G
BC- □□S- 192813	190 x 280 x 130	7.48 x 11.02 x 5.12	30	98	165 x 256 x 112	1928 S	1928 P	1928 G
BC- □□S- 192818	190 x 280 x 180	7.48 x 11.02 x 7.09	30	148	168 x 258 x 162	1928 S	1928 P	1928 G
BC- □□S- 193813	190 x 380 x 130	7.48 x 14.96 x 5.12	30	98	165 x 355 x 114	1938 S	1938 P	-
BC- □□S- 193818	190 x 380 x 180	7.48 x 14.96 x 7.09	30	148	165 x 355 x 164	1938 S	1938 P	-
BC- □□S- 282813	280 x 280 x 130	11.02 x 11.02 x 5.12	30	100	255 x 255 x 114	2828 S	2828 P	-
BC- □□S- 283413	280 x 340 x 130	11.02 x 13.39 x 5.12	30	98	256 x 314 x 112	2834 S	2834 P	-
BC- □□S- 283813	280 x 380 x 130	11.02 x 14.96 x 5.12	30	98	254 x 354 x 111	2838 S	2838 P	-
BC- □□S- 283818	280 x 380 x 180	11.02 x 14.96 x 7.09	30	148	255 x 355 x 162	2838 S	2838 P	-
BC- □□S- 285613	280 x 560 x 130	11.02 x 22.05 x 5.12	30	98	255 x 535 x 112	2856 S	-	-
BC- □□S- 334318	330 x 430 x 180	12.99 x 16.93 x 7.09	30	148	305 x 405 x 160	3343 S	3343 P	-
BC- □□S- 385618	380 x 560 x 180	14.96 x 22.05 x 7.09	30	148	349 x 535 x 160	3856 S	-	-

ACCESSORIES | 액세서리 | 配件

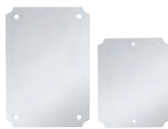

[Steel mounting plate]



[Plastic mounting plate]



[Cover screw(standard, CB28-)]



[Cover screw(optional, CB28+)]



[SUS bracket(B50)]
B50 : (Screw : TH M5x10)



[Plastic bracket(PB50)]
PB50 : (Screw : TH M5x12)



[Vent(V60, V80)]

Knock-Out Box

녹아웃 박스
敲落孔盒

80x110x70 ~ 125x175x100mm

FEATURE | 특성 | 特征

- Screw type, Knock out base
- 스크류 타입, 베이스 녹아웃 있는 제품
- 螺栓型, 敲落孔盒

SPECIFICATION | 사양 | 产品规格说明

- IP Rating / 방수, 방진 보호등급 / 防尘防水等级 | IP66/67
- IK Rating / 충격 테스트 / 冲击测试 | IK08
- Temperature Range / 온도영역 / 温度范围 | ABS : -40 ~ +70, PC : -40 ~ +110
- Flammability Rating / 난연성 / 阻燃等级 | ABS : 94-HB, PC : 94-V-0, 5VA, HB
- Certification / 인증 / 认证 | TUV, CE, UL (See page 6 / 6 페이지 참조 / 请参照第6页)

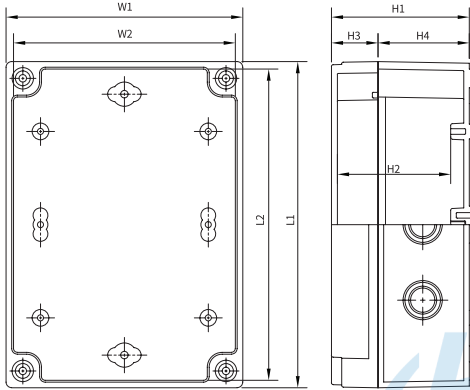

KNOCK-OUT BOX model name | 녹아웃 박스 모델선정방법 | 敲落孔盒 产品型号命名方法

BOXCO ① ② ③ ④ ⑤ ⑥ ⑦

BC - **S -** **08 11 07 - K**

- ① Material / 재료 / 材质 - A : ABS C : PC
- ② Cover / 커버색상 / 箱盖颜色 - G : Grey / 회색 / 灰色 T : Transparent / 투명 / 透明
- ③ Type / 타입 / 类型 - Screw Cover / 스크류 커버 / 螺栓型
- ④ Width / 가로 / 宽度(W)
- ⑤ Length / 세로 / 长度(L)
- ⑥ Height / 높이 / 高度(H) - Cover Included / 커버포함 / 含箱盖
- ⑦ Knock-Out / 녹아웃 / 敲落孔



Model 모델 / 型号	Product model / 제품모델 / 产品型号				Mounting plate / 속판모델 / 底板型号		
	Outside dimension 외부 치수 / 外部尺寸		Cover (H3)	Base (H4)	Inside dimension 내부 치수 / 内部尺寸	Steel 철 / 金属	Plastic 플라스틱 / 塑料
	Size (W1xL1xH1/mm)	Size (W1xL1xH1/inch)					
BC- <input type="checkbox"/> <input type="checkbox"/> S- 081107- K	80 x 110 x 70	3.15 x 4.33 x 2.76	20	50	72 x 102 x 56	-	-
BC- <input type="checkbox"/> <input type="checkbox"/> S- 081108- K	80 x 110 x 85	3.15 x 4.33 x 3.35	35	50	72 x 102 x 71	-	-
BC- <input type="checkbox"/> <input type="checkbox"/> S- 081307- K	80 x 130 x 70	3.15 x 5.12 x 2.76	20	50	72 x 122 x 56	-	-
BC- <input type="checkbox"/> <input type="checkbox"/> S- 081308- K	80 x 130 x 85	3.15 x 5.12 x 3.35	35	50	72 x 122 x 71	-	-
BC- <input type="checkbox"/> <input type="checkbox"/> S- 081807- K	80 x 180 x 70	3.15 x 7.09 x 2.76	20	50	72 x 172 x 57	-	-
BC- <input type="checkbox"/> <input type="checkbox"/> S- 081808- K	80 x 180 x 85	3.15 x 7.09 x 3.35	35	50	72 x 172 x 72	-	-
BC- <input type="checkbox"/> <input type="checkbox"/> S- 082507- K	80 x 250 x 70	3.15 x 9.84 x 2.76	20	50	72 x 242 x 57	-	-
BC- <input type="checkbox"/> <input type="checkbox"/> S- 082508- K	80 x 250 x 85	3.15 x 9.84 x 3.35	35	50	72 x 242 x 72	-	-
BC- <input type="checkbox"/> <input type="checkbox"/> S- 121707- K	125 x 175 x 75	4.92 x 6.89 x 2.95	25	50	119 x 167 x 61	1217 S	1217 P
BC- <input type="checkbox"/> <input type="checkbox"/> S- 121710- K	125 x 175 x 100	4.92 x 6.89 x 3.94	50	50	119 x 167 x 86	1217 S	1217 P

Push Button Box

푸시버튼 박스
按钮盒

HOLE : Ø22, Ø25, Ø30 (1 ~ 4 - HOLE)

FEATURE | 특성 | 特征

- Screw type, Knock out base
- This series has a pre-cut hole on the cover
- 스크류 타입, 베이스 녹아웃 있는 제품
- 커버홀이 있는 제품
- 螺栓型, 敲落孔盒
- 该系列盒盖有预先打好的孔

SPECIFICATION | 사양 | 产品规格说明

- Temperature Range / 온도영역 / 温度范围 | ABS : -40 ~ +70, PC : -40 ~ +110
- Flammability Rating / 난연성 / 阻燃等级 | ABS : 94-HB, PC : 94-V-0, 5VA, HB
- Certification / 인증 / 认证 | TUV, CE, UL (See page 6 / 6 페이지 참조 / 请参照第6页)



PUSH BUTTON HOLE

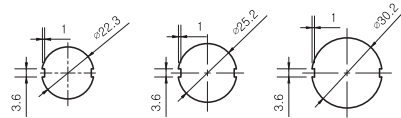

PUSH BUTTON HOLE SPACING

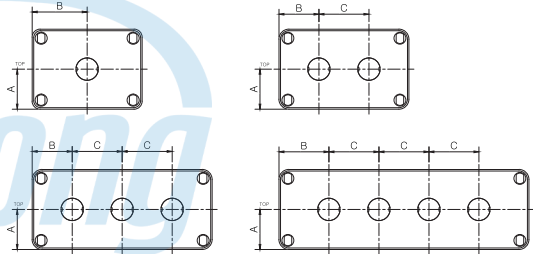

Model / 모델 / 型号	Hole	A	B	C
BC- □GS- 08110□- □□01	1-Hole	40	55	-
BC- □GS- 08130□- □□02	2-Hole	40	40	50
BC- □GS- 08180□- □□03	3-Hole	40	40	50
BC- □GS- 08250□- □□04	4-Hole	40	50	50

PUSH BUTTON BOX model name | 푸시버튼 박스 모델선정방법 | 按钮盒产品型号命名方法



- 1 Material / 재료 / 材质 - A : ABS C : PC
- 2 Cover / 커버색상 / 箱盖颜色 - G : Grey / 회색 / 灰色
- 3 Type / 타입 / 类型 - Screw Cover / 스크류 커버 / 螺栓型
- 4 Width / 가로 / 宽度(W)
- 5 Length / 세로 / 长度(L)
- 6 Height / 높이 / 高度(H) - 高度(H) Cover Included / 커버포함 / 含箱盖
- 7 Hole / 홈 개수 / 孔数

Model 모델 / 型号	Ø	Hole	Product model / 제품모델 / 产品型号				Inside depth(mm) 내부깊이 / 内部深度	
			Outside dimension 외부 치수 / 外部尺寸		Cover (H3)	Base (H4)		
			Size (W1xL1xH1/mm)	Size (W1xL1xH1/inch)				
BC- □GS- 081107- 2201	Ø22	1 HOLE	80 x 110 x 70	3.15 x 4.33 x 2.76	20	50	57	
BC- □GS- 081108- 2201			80 x 110 x 85	3.15 x 4.33 x 3.35	35	50	72	
BC- □GS- 081307- 2202			2 HOLE	80 x 130 x 70	3.15 x 5.12 x 2.76	20	50	57
BC- □GS- 081308- 2202				80 x 130 x 85	3.15 x 5.12 x 3.35	35	50	72
BC- □GS- 081807- 2203		Ø25	3 HOLE	80 x 180 x 70	3.15 x 7.09 x 2.76	20	50	57
BC- □GS- 081808- 2203				80 x 180 x 85	3.15 x 7.09 x 3.35	35	50	72
BC- □GS- 082507- 2204			4 HOLE	80 x 250 x 70	3.15 x 9.84 x 2.76	20	50	57
BC- □GS- 082508- 2204				80 x 250 x 85	3.15 x 9.84 x 3.35	35	50	72
BC- □GS- 081107- 2501	Ø25	1 HOLE	80 x 110 x 70	3.15 x 4.33 x 2.76	20	50	57	
BC- □GS- 081108- 2501			80 x 110 x 85	3.15 x 4.33 x 3.35	35	50	72	
BC- □GS- 081307- 2502		2 HOLE	80 x 130 x 70	3.15 x 5.12 x 2.76	20	50	57	
BC- □GS- 081308- 2502			80 x 130 x 85	3.15 x 5.12 x 3.35	35	50	72	
BC- □GS- 081807- 2503		Ø30	3 HOLE	80 x 180 x 70	3.15 x 7.09 x 2.76	20	50	57
BC- □GS- 081808- 2503				80 x 180 x 85	3.15 x 7.09 x 3.35	35	50	72
BC- □GS- 082507- 2504			4 HOLE	80 x 250 x 70	3.15 x 9.84 x 2.76	20	50	57
BC- □GS- 082508- 2504				80 x 250 x 85	3.15 x 9.84 x 3.35	35	50	72
BC- □GS- 081107- 3001	Ø30	1 HOLE	80 x 110 x 70	3.15 x 4.33 x 2.76	20	50	57	
BC- □GS- 081108- 3001			80 x 110 x 85	3.15 x 4.33 x 3.35	35	50	72	
BC- □GS- 081307- 3002		2 HOLE	80 x 130 x 70	3.15 x 5.12 x 2.76	20	50	57	
BC- □GS- 081308- 3002			80 x 130 x 85	3.15 x 5.12 x 3.35	35	50	72	
BC- □GS- 081807- 3003		Ø30	3 HOLE	80 x 180 x 70	3.15 x 7.09 x 2.76	20	50	57
BC- □GS- 081808- 3003				80 x 180 x 85	3.15 x 7.09 x 3.35	35	50	72
BC- □GS- 082507- 3004			4 HOLE	80 x 250 x 70	3.15 x 9.84 x 2.76	20	50	57
BC- □GS- 082508- 3004				80 x 250 x 85	3.15 x 9.84 x 3.35	35	50	72

Push Button Box

푸시버튼 박스
按钮盒

HOLE : Ø22, Ø25, Ø30 (1 ~ 4 - HOLE)

FEATURE | 특성 | 特征

- Screw type, Knock out base
- This series has a pre-cut hole on the cover
- 스크류 타입, 베이스 녹아웃 있는 제품
- 커버홀이 있는 제품
- 螺柱型, 敲落孔盒
- 该系列盒盖有预先打好的孔

SPECIFICATION | 사양 | 产品规格说明

- Temperature Range / 온도영역 / 温度范围 | ABS : - 40 ~ + 70, PC : - 40 ~ + 110
- Flammability Rating / 난연성 / 阻燃等级 | ABS : 94-HB, PC : 94-V-0, 5VA, HB
- Certification / 인증 / 认证 | TUV, CE



PUSH BUTTON HOLE

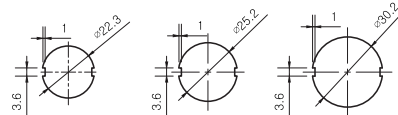

PUSH BUTTON HOLE SPACING

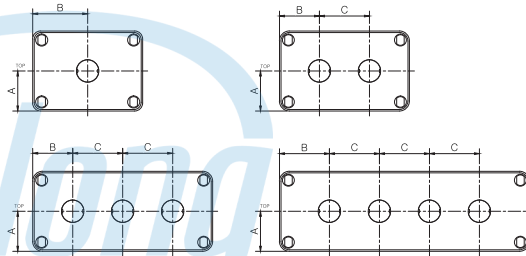

Model / 모델 / 型号	Hole	A	B	C
BC- A□S- 08110□- □□01	1-Hole	40	55	-
BC- A□S- 08130□- □□02	2-Hole	40	40	50
BC- A□S- 08180□- □□03	3-Hole	40	40	50
BC- A□S- 08250□- □□04	4-Hole	40	50	50

PUSH BUTTON BOX model name | 푸시버튼 박스 모델선정방법 | 按钮盒产品型号命名方法



- 1 Material / 재료 / 材质 - A : ABS
- 2 Cover / 커버색상 / 箱盖颜色 - Y : Yellow / 노란색 / 黄色 R : Red / 빨간색 / 红色
- 3 Type / 타입 / 类型 - Screw Cover / 스크류 커버 / 螺柱型
- 4 Width / 가로 / 宽度(W)
- 5 Length / 세로 / 长度(L)
- 6 Height / 높이 / 高度(H) - 高度(H) Cover Included / 커버포함 / 含箱盖
- 7 Hole / 홀 개수 / 孔数

INDUSTRIAL AUTOMATION

Product model / 제품모델 / 产品型号							
Model 모델 / 型号	Ø	Hole	Outside dimension 외부 치수 / 外部尺寸				Inside depth(mm) 내부깊이 / 内部深度
			Size (W1xL1xH1/mm)	Size (W1xL1xH1/inch)	Cover (H3)	Base (H4)	
BC- A□S- 081107- 2201	Ø22	1 HOLE	80 x 110 x 70	3.15 x 4.33 x 2.76	20	50	57
BC- A□S- 081108- 2201			80 x 110 x 85	3.15 x 4.33 x 3.35	35	50	72
BC- A□S- 081307- 2202		2 HOLE	80 x 130 x 70	3.15 x 5.12 x 2.76	20	50	57
BC- A□S- 081308- 2202			80 x 130 x 85	3.15 x 5.12 x 3.35	35	50	72
BC- A□S- 081807- 2203		3 HOLE	80 x 180 x 70	3.15 x 7.09 x 2.76	20	50	57
BC- A□S- 081808- 2203			80 x 180 x 85	3.15 x 7.09 x 3.35	35	50	72
BC- A□S- 082507- 2204		4 HOLE	80 x 250 x 70	3.15 x 9.84 x 2.76	20	50	57
BC- A□S- 082508- 2204			80 x 250 x 85	3.15 x 9.84 x 3.35	35	50	72
BC- A□S- 081107- 2501	Ø25	1 HOLE	80 x 110 x 70	3.15 x 4.33 x 2.76	20	50	57
BC- A□S- 081108- 2501			80 x 110 x 85	3.15 x 4.33 x 3.35	35	50	72
BC- A□S- 081307- 2502		2 HOLE	80 x 130 x 70	3.15 x 5.12 x 2.76	20	50	57
BC- A□S- 081308- 2502			80 x 130 x 85	3.15 x 5.12 x 3.35	35	50	72
BC- A□S- 081807- 2503		3 HOLE	80 x 180 x 70	3.15 x 7.09 x 2.76	20	50	57
BC- A□S- 081808- 2503			80 x 180 x 85	3.15 x 7.09 x 3.35	35	50	72
BC- A□S- 082507- 2504		4 HOLE	80 x 250 x 70	3.15 x 9.84 x 2.76	20	50	57
BC- A□S- 082508- 2504			80 x 250 x 85	3.15 x 9.84 x 3.35	35	50	72
BC- A□S- 081107- 3001	Ø30	1 HOLE	80 x 110 x 70	3.15 x 4.33 x 2.76	20	50	57
BC- A□S- 081108- 3001			80 x 110 x 85	3.15 x 4.33 x 3.35	35	50	72
BC- A□S- 081307- 3002		2 HOLE	80 x 130 x 70	3.15 x 5.12 x 2.76	20	50	57
BC- A□S- 081308- 3002			80 x 130 x 85	3.15 x 5.12 x 3.35	35	50	72
BC- A□S- 081807- 3003		3 HOLE	80 x 180 x 70	3.15 x 7.09 x 2.76	20	50	57
BC- A□S- 081808- 3003			80 x 180 x 85	3.15 x 7.09 x 3.35	35	50	72
BC- A□S- 082507- 3004		4 HOLE	80 x 250 x 70	3.15 x 9.84 x 2.76	20	50	57
BC- A□S- 082508- 3004			80 x 250 x 85	3.15 x 9.84 x 3.35	35	50	72

Terminal Block Box

단자박스
端子盒

4P ~ 20P

SPECIFICATION | 사양 | 产品规格说明

- IP Rating / 방수, 방진 보호등급 / 防尘防水等级 | IP66/67
- IK Rating / 충격 테스트 / 冲击测试 | IK 08
- Rated Insulation Voltage / 절연정격전압 / 正常耐压 | 400V
- Rated Current Capacity / 정격전류용량 / 正常电流量 | 0.75mm sq. - 1.5mm sq.
- Temperature Range / 온도영역 / 温度范围 | ABS : - 40 ~ + 70, PC : - 40 ~ + 110
- Flammability Rating / 난연성 / 阻燃等级 | ABS : 94-V-0, HB, PC : 94-HB, PBT : 94-V-0
- Certification / 인증 / 认证 | TUV, CE



TERMINAL BLOCK BOX model name

단자박스 모델선정방법 | 端子盒 产品型号命名方法

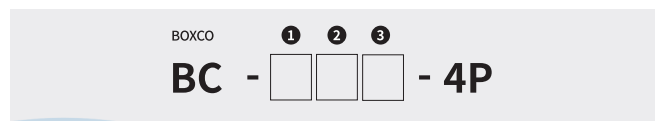

- ① Material / 재료 / 材质 - A : ABS T : PBT
- ② Cover / 커버색상 / 箱盖颜色 - G : Opaque / 불투명 / 不透明 T : Transparent / 투명 / 透明
- ③ Base / 베이스색상 / 盒底颜色 - G : Grey / 회색 / 灰色 B : Grayish blue / 청회색 / 青灰色

4P

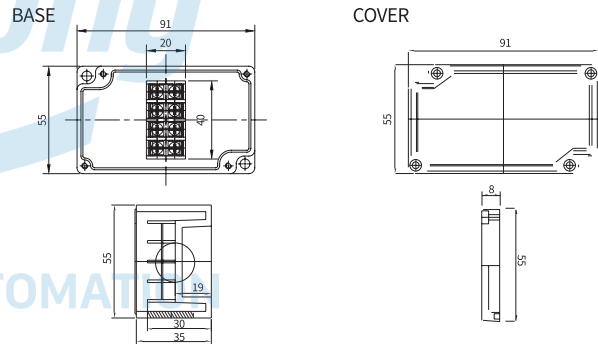
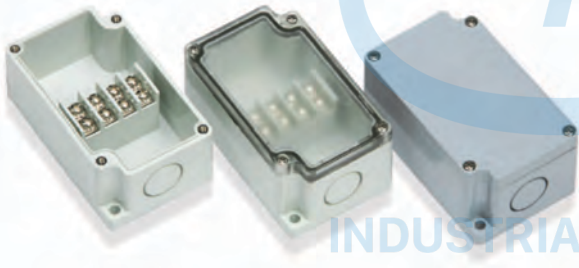

Model size / 모델사이즈 / 型号尺寸	Product model / 제품모델 / 产品型号			
Size (WxLxH/mm) 사이즈 / 尺寸	ABS Grey ABS회색 / ABS灰色		ABS Grayish blue ABS청회색 / ABS青灰色	
	Opaque 불투명 / 不透明	Transparent 투명 / 透明	Opaque 불투명 / 不透明	Transparent 투명 / 透明
55 x 91 x 43 x 21(Knock out)	BC- AGG- 4P	BC- ATG- 4P	BC- AGB- 4P	BC- ATB- 4P

4PH

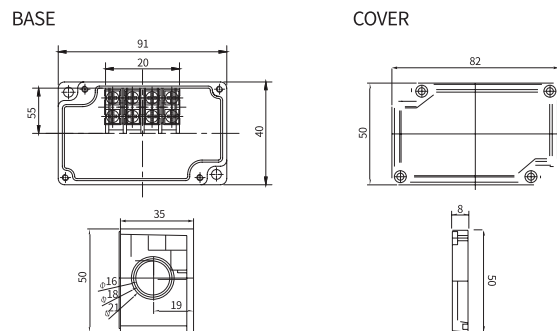
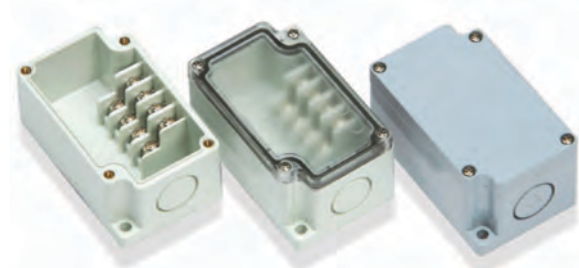

Model size / 모델사이즈 / 型号尺寸	Product model / 제품모델 / 产品型号			
Size (WxLxH/mm) 사이즈 / 尺寸	ABS Grey ABS회색 / ABS灰色		ABS Grayish blue ABS청회색 / ABS青灰色	
	Opaque 불투명 / 不透明	Transparent 투명 / 透明	Opaque 불투명 / 不透明	Transparent 투명 / 透明
50 x 82 x 43 x 21(Knock out)	BC- AGG- 4PH	BC- ATG- 4PH	BC- AGB- 4PH	BC- ATB- 4PH

4PT

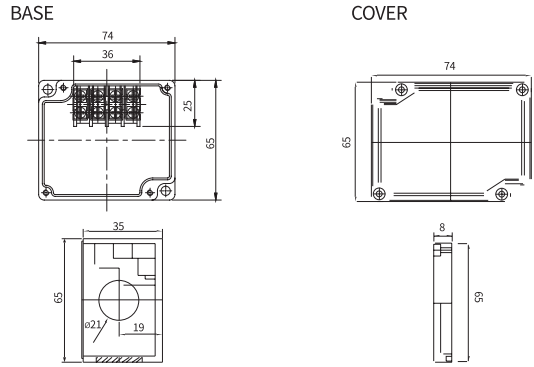

Model size / 모델사이즈 / 型号尺寸	Product model / 제품모델 / 产品型号			
Size (WxLxH/mm) 사이즈 / 尺寸	ABS Grey ABS회색 / ABS灰色		ABS Grayish blue ABS청회색 / ABS青灰色	
	Opaque 불투명 / 不透明	Transparent 투명 / 透明	Opaque 불투명 / 不透明	Transparent 투명 / 透明
65 x 74 x 43 x 21(Knock out)	BC- AGG- 4PT	BC- ATG- 4PT	BC- AGB- 4PT	BC- ATB- 4PT

6P

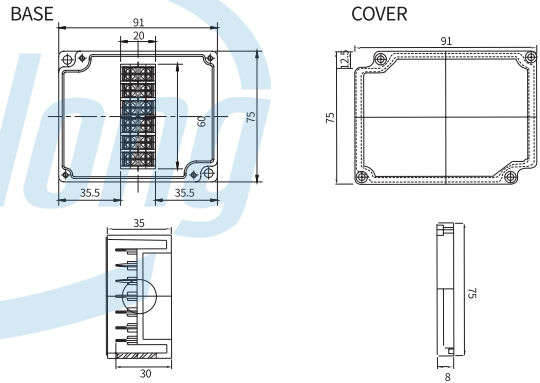
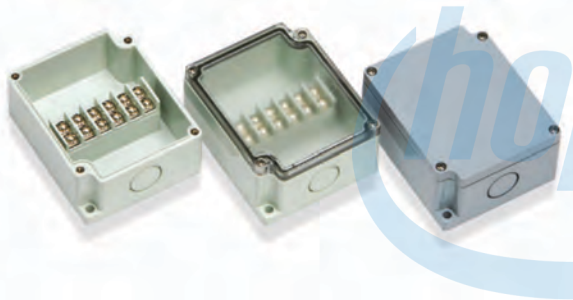

Model size / 모델사이즈 / 型号尺寸	Product model / 제품모델 / 产品型号			
Size (WxLxH/mm) 사이즈 / 尺寸	ABS Grey ABS회색 / ABS灰色		ABS Grayish blue ABS청회색 / ABS青灰色	
	Opaque 불투명 / 不透明	Transparent 투명 / 透明	Opaque 불투명 / 不透明	Transparent 투명 / 透明
75 x 91 x 43 x 21(Knock out)	BC- AGG- 6P	BC- ATG- 6P	BC- AGB- 6P	BC- ATB- 6P

6PH

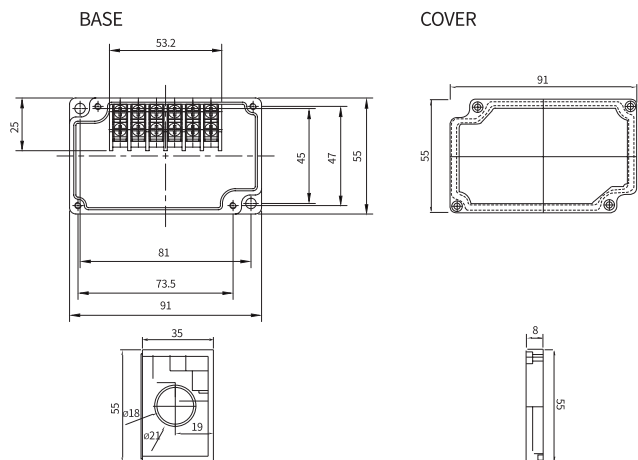
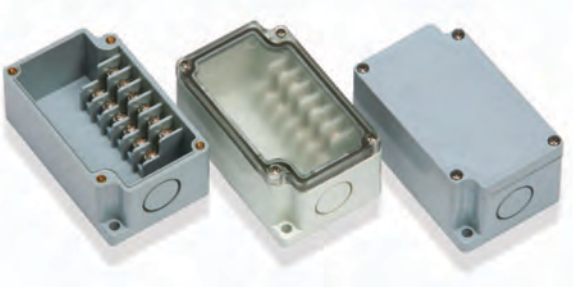

Model size / 모델사이즈 / 型号尺寸	Product model / 제품모델 / 产品型号			
Size (WxLxH/mm) 사이즈 / 尺寸	ABS Grey ABS회색 / ABS灰色		ABS Grayish blue ABS청회색 / ABS青灰色	
	Opaque 불투명 / 不透明	Transparent 투명 / 透明	Opaque 불투명 / 不透明	Transparent 투명 / 透明
55 x 91 x 43 x 21(Knock out)	BC- AGG- 6PH	BC- ATG- 6PH	BC- AGB- 6PH	BC- ATB- 6PH

6PT

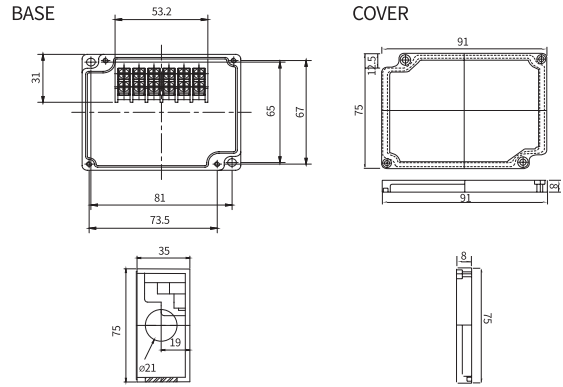

Model size / 모델사이즈 / 型号尺寸	Product model / 제품모델 / 产品型号			
Size (WxLxH/mm) 사이즈 / 尺寸	ABS Grey ABS회색 / ABS灰色		ABS Grayish blue ABS청회색 / ABS青灰色	
	Opaque 불투명 / 不透明	Transparent 투명 / 透明	Opaque 불투명 / 不透明	Transparent 투명 / 透明
75 x 91 x 43 x 21(Knock out)	BC- AGG- 6PT	BC- ATG- 6PT	BC- AGB- 6PT	BC- ATB- 6PT

10P

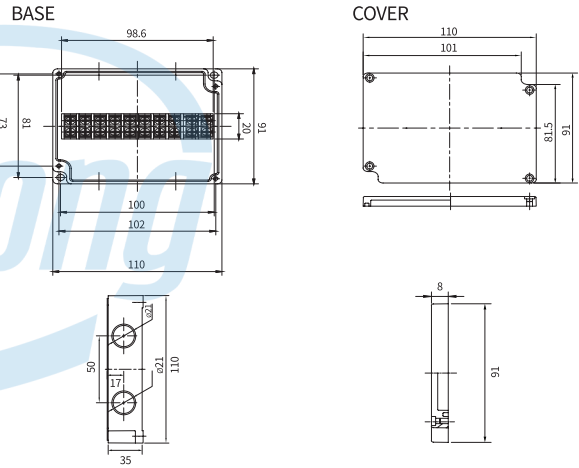
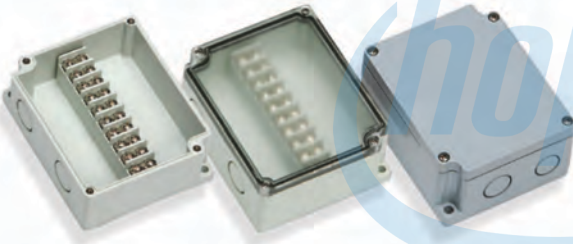

Model size / 모델사이즈 / 型号尺寸	Product model / 제품모델 / 产品型号			
Size (WxLxH/mm) 사이즈 / 尺寸	ABS Grey ABS회색 / ABS灰色		ABS Grayish blue ABS청회색 / ABS青灰色	
	Opaque 불투명 / 不透明	Transparent 투명 / 透明	Opaque 불투명 / 不透明	Transparent 투명 / 透明
91 x 110 x 43 x 21(Knock out)	BC- AGG- 10P	BC- ATG- 10P	BC- AGB- 10P	BC- ATB- 10P

10PT

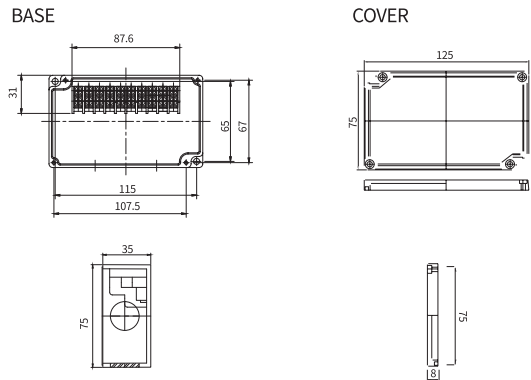

Model size / 모델사이즈 / 型号尺寸	Product model / 제품모델 / 产品型号			
Size (WxLxH/mm) 사이즈 / 尺寸	ABS Grey ABS회색 / ABS灰色		ABS Grayish blue ABS청회색 / ABS青灰色	
	Opaque 불투명 / 不透明	Transparent 투명 / 透明	Opaque 불투명 / 不透明	Transparent 투명 / 透明
75 x 125 x 43 x 21(Knock out)	BC- AGG- 10PT	BC- ATG- 10PT	BC- AGB- 10PT	BC- ATB- 10PT

15P

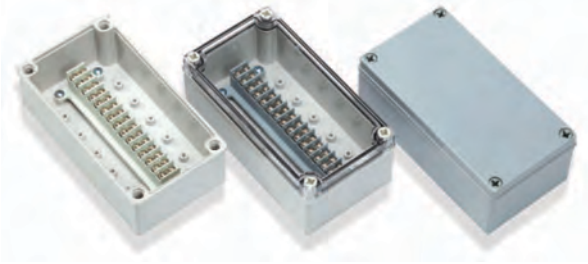

BASE

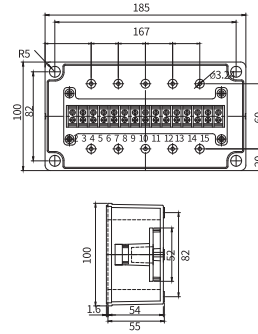

COVER

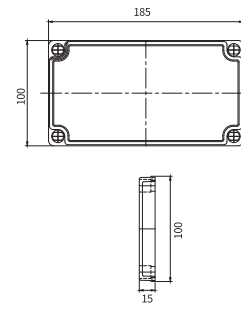

Model size / 모델사이즈 / 型号尺寸	Product model / 제품모델 / 产品型号			
Size (WxLxH/mm) 사이즈 / 尺寸	ABS Grey ABS회색 / ABS灰色		ABS Grayish blue ABS청회색 / ABS青灰色	
	Opaque 불투명 / 不透明	Transparent 투명 / 透明	Opaque 불투명 / 不透明	Transparent 투명 / 透明
100 x 185 x 70	BC- AGG- 15P	BC- ATG- 15P	BC- AGB- 15P	BC- ATB- 15P

15PT

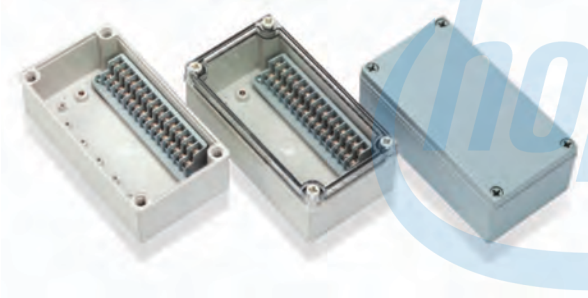

BASE

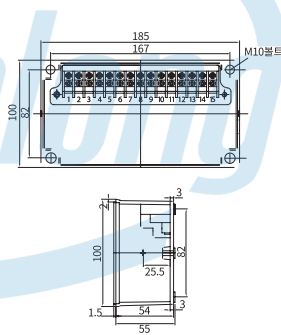

COVER

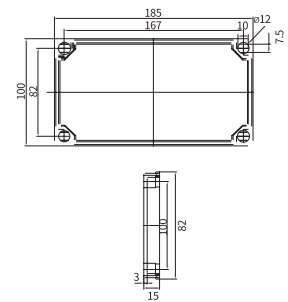

Model size / 모델사이즈 / 型号尺寸	Product model / 제품모델 / 产品型号			
Size (WxLxH/mm) 사이즈 / 尺寸	ABS Grey ABS회색 / ABS灰色		ABS Grayish blue ABS청회색 / ABS青灰色	
	Opaque 불투명 / 不透明	Transparent 투명 / 透明	Opaque 불투명 / 不透明	Transparent 투명 / 透明
100 x 185 x 70	BC- AGG- 15PT	BC- ATG- 15PT	BC- AGB- 15PT	BC- ATB- 15PT

20P



BASE

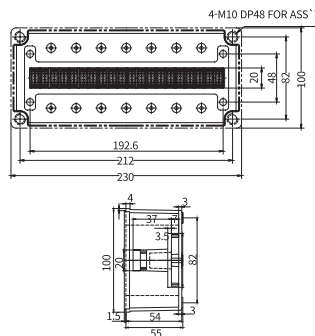

COVER

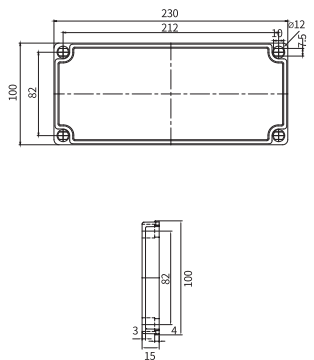

Model size / 모델사이즈 / 型号尺寸	Product model / 제품모델 / 产品型号			
Size (WxLxH/mm) 사이즈 / 尺寸	ABS Grey ABS회색 / ABS灰色		ABS Grayish blue ABS청회색 / ABS青灰色	
	Opaque 불투명 / 不透明	Transparent 투명 / 透明	Opaque 불투명 / 不透明	Transparent 투명 / 透明
100 x 230 x 70	BC- AGG- 20P	BC- ATG- 20P	BC- AGB- 20P	BC- ATB- 20P

20PT

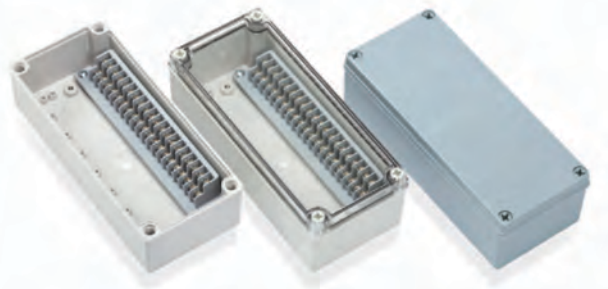

BASE

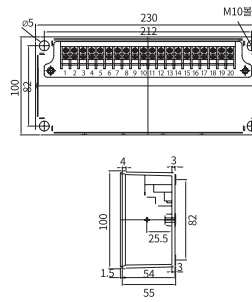

COVER

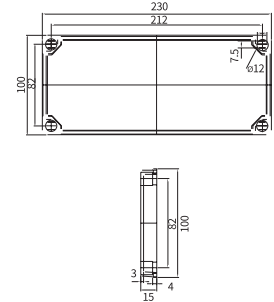

Model size / 모델사이즈 / 型号尺寸	Product model / 제품모델 / 产品型号			
Size (WxLxH/mm) 사이즈 / 尺寸	ABS Grey ABS회색 / ABS灰色		ABS Grayish blue ABS청회색 / ABS青灰色	
	Opaque 불투명 / 不透明	Transparent 투명 / 透明	Opaque 불투명 / 不透明	Transparent 투명 / 透明
100 x 230 x 70	BC- AGG- 20PT	BC- ATG- 20PT	BC- AGB- 20PT	BC- ATB- 20PT

20PA

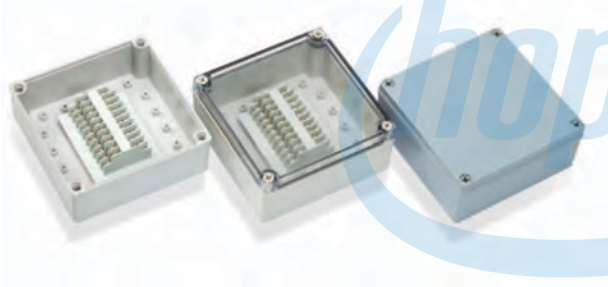

BASE

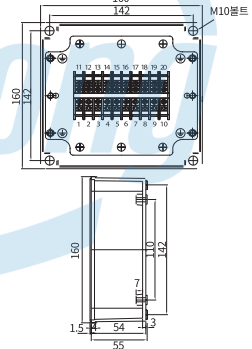

COVER

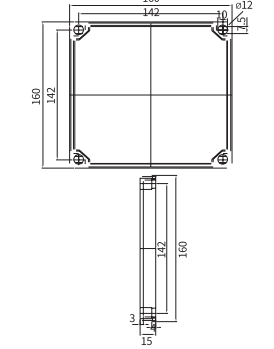

Model size / 모델사이즈 / 型号尺寸	Product model / 제품모델 / 产品型号			
Size (WxLxH/mm) 사이즈 / 尺寸	ABS Grey ABS회색 / ABS灰色		ABS Grayish blue ABS청회색 / ABS青灰色	
	Opaque 불투명 / 不透明	Transparent 투명 / 透明	Opaque 불투명 / 不透明	Transparent 투명 / 透明
160 x 160 x 70	BC- AGG- 20PA	BC- ATG- 20PA	BC- AGB- 20PA	BC- ATB- 20PA

20P2

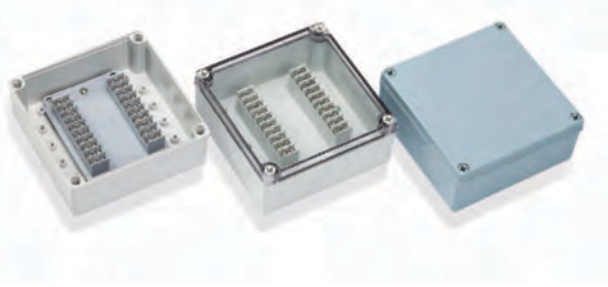

BASE

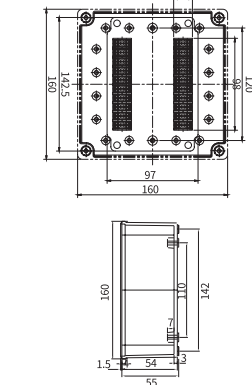

COVER

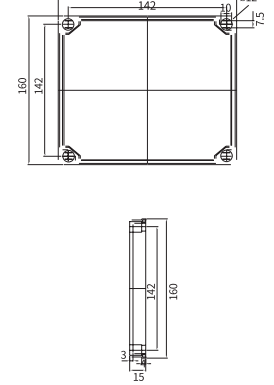

Model size / 모델사이즈 / 型号尺寸	Product model / 제품모델 / 产品型号			
Size (WxLxH/mm) 사이즈 / 尺寸	ABS Grey ABS회색 / ABS灰色		ABS Grayish blue ABS청회색 / ABS青灰色	
	Opaque 불투명 / 不透明	Transparent 투명 / 透明	Opaque 불투명 / 不透明	Transparent 투명 / 透明
160 x 160 x 70	BC- AGG- 20P2	BC- ATG- 20P2	BC- AGB- 20P2	BC- ATB- 20P2

3PC

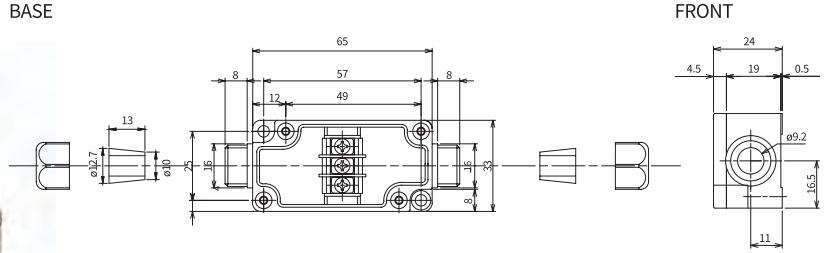

Model size / 모델사이즈 / 型号尺寸		Product model / 제품모델 / 产品型号					
Size (WxLxH/mm) 사이즈 / 尺寸	ABS Grey ABS회색 / ABS灰色		PBT Grey PBT 회색 / PBT灰色		PBT Black PBT 블랙 / PBT 黑色		
	Opaque 불투명 / 不透明	Transparent 투명 / 透明	Opaque 불투명 / 不透明	Transparent 투명 / 透明	Opaque 불투명 / 不透明	Transparent 투명 / 透明	
33 x 65 x 24 x 9	BC- AGG- 3PC	BC- ATG- 3PC	BC- TGG- 3PC	BC- TTG- 3PC	BC- TBB- 3PC	BC- TTB- 3PC	

4PC

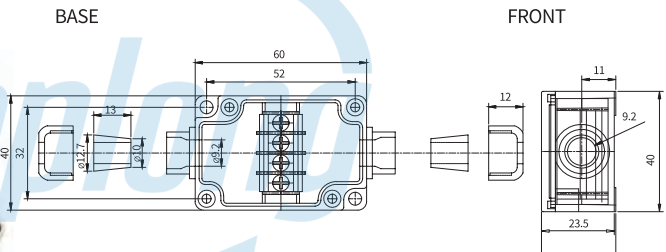

Model size / 모델사이즈 / 型号尺寸		Product model / 제품모델 / 产品型号					
Size (WxLxH/mm) 사이즈 / 尺寸	ABS Grey ABS회색 / ABS灰色		PBT Grey PBT 회색 / PBT灰色		PBT Black PBT 블랙 / PBT 黑色		
	Opaque 불투명 / 不透明	Transparent 투명 / 透明	Opaque 불투명 / 不透明	Transparent 투명 / 透明	Opaque 불투명 / 不透明	Transparent 투명 / 透明	
40 x 60 x 24 x 9	BC- AGG- 4PC	BC- ATG- 4PC	BC- TGG- 4PC	BC- TTG- 4PC	BC- TBB- 4PC	BC- TTB- 4PC	

6PC

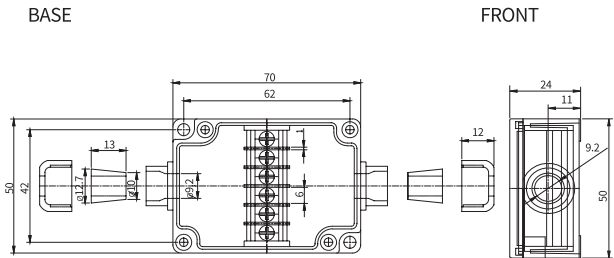

Model size / 모델사이즈 / 型号尺寸		Product model / 제품모델 / 产品型号					
Size (WxLxH/mm) 사이즈 / 尺寸	ABS Grey ABS회색 / ABS灰色		PBT Grey PBT 회색 / PBT灰色		PBT Black PBT 블랙 / PBT 黑色		
	Opaque 불투명 / 不透明	Transparent 투명 / 透明	Opaque 불투명 / 不透明	Transparent 투명 / 透明	Opaque 불투명 / 不透明	Transparent 투명 / 透明	
50 x 70 x 24 x 9	BC- AGG- 6PC	BC- ATG- 6PC	BC- TGG- 6PC	BC- TTG- 6PC	BC- TBB- 6PC	BC- TTB- 6PC	

SMPS Case SMPS 박스 / SMPS 盒

VENT IS OPTIONAL | 환기구별도 | 排气扇除外

BC- SMPS- 162609



Example of application / 적용예 / 实例

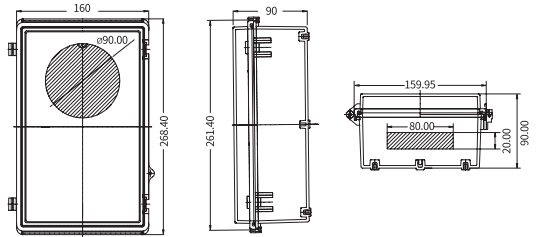

FEATURE | 특성 | 特征

- It has hole for installing vent in front. It is easy to assemble terminal block through cutting rectangle on the bottom.
- 전면에 환기구(Vent)를 부착할 수 있는 홀 가공이 되어 있으며, 하부에 단자대 조립이 쉽도록 사각 커팅이 되어 있습니다.
- 考虑到内部散热盒盖安装了通风窗，为了方便接线底部做了方型孔。

Model 모델 / 型号	Size (W譜謔/mm) 사이즈 / 尺寸
BC- SMPS- 162609	160 x 260 x 90

CONCENT Case CONCENT 박스 / CONCENT 盒

BC- CONCENT- 131508



Example of application / 적용예 / 实例



FEATURE | 특성 | 特征

- There are each three knockouts of 21mm in top and bottom and two U holes for drop wire.
- 상, 하부에 21Ø 너아웃 (Knock out)이 3개씩 있으며 전선 인입용 U홀이 2개 가공되어 있습니다.
- 上下部分别设有三个敲落孔(21φ), 为了方便连接电线, 另设有两个U形孔。

Model 모델 / 型号	Size (W譜謔/mm) 사이즈 / 尺寸
BC- CONCENT- 131508	135 x 150 x 80

BC-AB-111108



Example of bracket / 브라켓사용예 / 使用实例

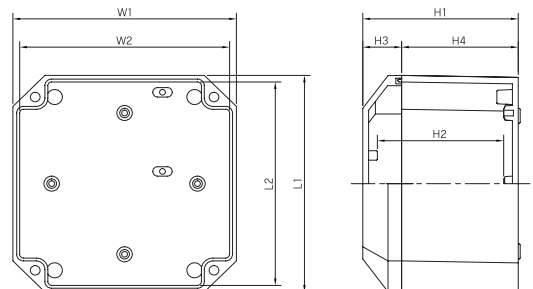

Model 모델 / 型号	Outside dimension 외부 치수 / 外部尺寸			Inside dimension 내부 치수 / 内部尺寸
	Size (W1xL1xH1/mm)	Cover (H3)	Base (H4)	Size (W2xL2xH2/mm)
BC- AB- 111108	115 x 115 x 80	20	60	108 x 108 x 65

Plastic bracket is optional(BC-PB1111) / 플라스틱 브라켓 별도구매(BC-PB1111) / 塑料挂件单独购买(BC-PB1111)

02

ALUMINUM BOX

알루미늄 박스
铸铝盒



Aluminum ALS Series
Aluminum AL Series
Aluminum Push Button Box
Aluminum Terminal Block Box

알루미늄 ALS 시리즈
알루미늄 AL 시리즈
알루미늄 푸시버튼 박스
알루미늄 단자박스

铸铝ALS系列
铸铝AL系列
铸铝按钮盒
铸铝端子盒

• Dimensions and specifications are subject to change without notice.

• 규격 및 사양은 사전 예고 없이 변경될 수 있습니다.

• 厂家会在没有任何提前通知的情况下更改产品规格与样式。

Aluminum ALS Series

알루미늄 ALS 시리즈
铸铝ALS系列

60x70x50 ~ 125x190x80mm

FEATURE | 특성 | 特征

- Screw type, RAL7001
- 스크류 타입, RAL 7001
- 螺栓型, RAL7001

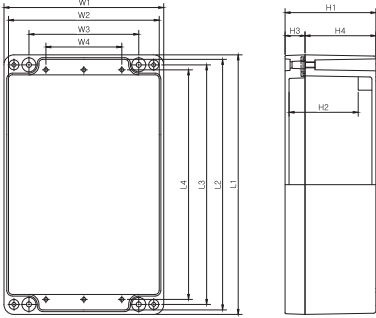

ALUMINUM BOX model name | 알루미늄 박스 모델선정방법 | 铸铝盒产品型号命名方法

BOXCO ① ② ③ ④
BC - AL - **06 07 05**

- ① Material / 재료 / 材质 - Aluminum diecasting
- ② Width / 가로 / 宽度(W)
- ③ Length / 세로 / 长度(L)
- ④ Height / 높이 / 高度(H) - Cover Included / 커버포함 / 含箱盖

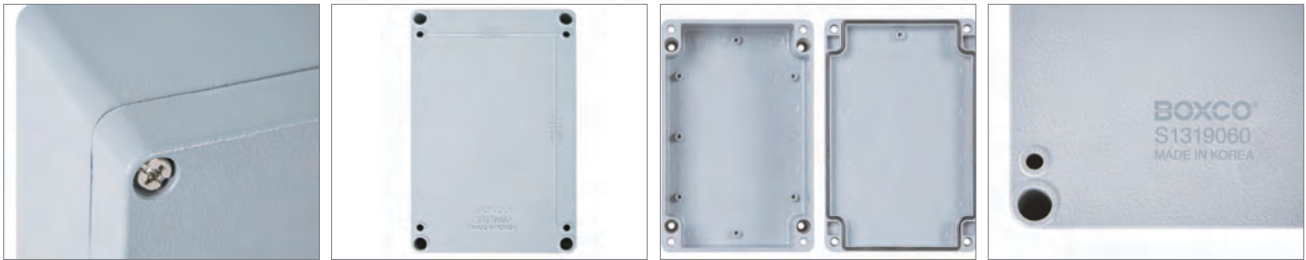

Product model / 제품모델 / 产品型号						Mounting plate / 속판모델 / 底板型号	
Model 모델 / 型号	Outside dimension 외부 치수 / 外部尺寸				Inside dimension 내부 치수 / 内部尺寸		Steel 철 / 金属
	Size (W1xL1xH1/mm)	Size (W1xL1xH1/inch)	Cover (H3)	Base (H4)	Size (W2xL2xH2/mm)		
BC- ALS- 060705	60 x 70 x 50	2.36 x 2.76 x 1.97	9	41	62 x 42 x 45		0607 A
BC- ALS- 071006	70 x 100 x 55	2.76 x 3.94 x 2.17	9	46	92 x 62 x 50		0710 A
BC- ALS- 071306	70 x 128 x 55	2.76 x 5.04 x 2.17	9	46	120 x 62 x 50		0713 A
BC- ALS- 071706	70 x 171 x 55	2.76 x 6.73 x 2.17	9	46	163 x 62 x 50		0717 A
BC- ALS- 082308	80 x 230 x 80	3.15 x 9.06 x 3.15	20	60	222 x 71 x 75		0823 A
BC- ALS- 111106	110 x 110 x 55	4.33 x 4.33 x 2.17	9	46	98 x 98 x 50		1111 A
BC- ALS- 131507	125 x 150 x 65	4.92 x 5.91 x 2.56	10	55	141 x 116 x 60		1315 A
BC- ALS- 131908	125 x 190 x 80	4.92 x 7.48 x 3.15	20	60	183 x 118 x 74		1319 A

Aluminum AL Series

알루미늄 AL 시리즈
铸铝AL系列

45x50x32 ~ 313x404x181mm

FEATURE | 특성 | 特征

- Screw type, RAL7001
- 스크류 타입, RAL 7001
- 螺栓型, RAL7001

SPECIFICATION | 사양 | 产品规格说明

- IP Rating / 방수, 방진 보호등급 / 防尘防水等级 | IP66/67
- IK Rating / 충격 테스트 / 冲击测试 | IK08
- Certification / 인증 / 认证 | TÜV, CE

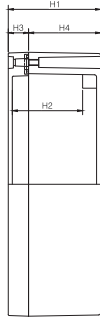
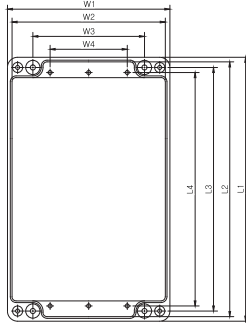

Product model / 제품모델 / 产品型号						Mounting plate / 속판모델 / 底板型号
Model 모델 / 型号	Outside dimension 외부 치수 / 外部尺寸			Inside dimension 내부 치수 / 内部尺寸		Steel 철 / 金属
	Size (W1xL1xH1/mm)	Size (W1xL1xH1/inch)	Cover (H3)	Base (H4)	Size (W2xL2xH2/mm)	
BC-AL-050503	45 x 50 x 32	1.77 x 1.96 x 1.25	7	25	46 X 41 X 27	-
BC-AL-060603	64 x 58 x 34	2.51 x 2.28 x 1.33	9	25	58 X 52 X 29	-
BC-AL-060605	64 x 58 x 46	2.51 x 2.28 x 1.81	9	37	58 X 52 X 41	-
BC-AL-061003	64 x 98 x 34	2.51 x 3.85 x 1.33	9	25	92 X 58 X 29	-
BC-AL-061005	64 x 98 x 46	2.51 x 3.85 x 1.81	9	37	92 X 58 X 41	-
BC-AL-061503	64 x 150 x 34	2.51 x 5.90 x 1.33	9	25	144 X 58 X 29	-
BC-AL-061505	64 x 150 x 46	2.51 x 5.90 x 1.81	9	37	144 X 58 X 41	-
BC-AL-080806	80 x 75 x 57	3.14 x 2.95 x 2.24	15	42	72 X 67 X 49	0808 A
BC-AL-080807	80 x 75 x 70	3.14 x 2.95 x 2.75	15	55	72 X 67 X 62	0808 A
BC-AL-081306	80 x 125 x 57	3.14 x 4.92 x 2.24	15	42	117 X 72 X 50	0813 A
BC-AL-081307	80 x 125 x 70	3.14 x 4.92 x 2.75	15	55	117 X 72 X 63	0813 A
BC-AL-081806	80 x 175 x 57	3.14 x 6.88 x 2.24	15	42	167 X 72 X 51	0818 A
BC-AL-081807	80 x 175 x 70	3.14 x 6.88 x 2.75	15	55	167 X 72 X 63	0818 A
BC-AL-082506	80 x 250 x 57	3.14 x 9.84 x 2.24	15	42	240 X 70 X 50	0825 A
BC-AL-082507	80 x 250 x 70	3.14 x 9.84 x 2.75	15	55	240 X 70 X 63	0825 A
BC-AL-101008	100 x 100 x 81	3.93 x 3.93 x 3.18	20	61	91 X 91 X 74	1010 A
BC-AL-101608	100 x 160 x 81	3.93 x 6.29 x 3.18	20	61	151 X 91 X 74	1016 A
BC-AL-121208	120 x 122 x 81	4.72 x 4.80 x 3.18	20	61	113 X 111 X 74	1212 A
BC-AL-122208	120 x 220 x 81	4.72 x 8.66 x 3.18	20	61	211 X 111 X 74	1222 A
BC-AL-122209	120 x 220 x 91	4.72 x 8.66 x 3.58	30	61	211 X 111 X 82	1222 A
BC-AL-123608	120 x 360 x 81	4.72 x 14.17 x 3.18	20	61	351 X 111 X 72	1236 A
BC-AL-151309	150 x 132 x 90	5.90 x 5.19 x 3.54	20	71	141 X 123 X 82	1513 A
BC-AL-161609	160 x 160 x 91	6.29 x 6.29 x 3.58	20	71	151 X 151 X 82	1616 A
BC-AL-162110	160 x 210 x 100	6.29 x 8.26 x 3.93	20	80	200 X 150 X 92	1621 A
BC-AL-162609	160 x 260 x 91	6.29 x 10.23 x 3.58	20	71	251 X 151 X 82	1626 A
BC-AL-163609	160 x 360 x 91	6.29 x 14.17 x 3.58	20	71	349 X 149 X 83	1636 A
BC-AL-181810	180 x 180 x 101	7.08 x 7.08 x 3.97	30	71	171 X 171 X 92	1818 A
BC-AL-232011	230 x 200 x 111	9.05 x 7.87 x 4.37	20	91	220 X 190 X 102	2320 A
BC-AL-232018	230 x 200 x 180	9.05 x 7.87 x 7.08	20	160	222 X 192 X 167	2320 A
BC-AL-232811	230 x 280 x 111	9.05 x 11.02 x 4.37	20	91	270 X 220 X 102	2328 A
BC-AL-233311	230 x 330 x 111	9.05 x 12.99 x 4.37	20	91	320 X 220 X 102	2333 A
BC-AL-314011	313 x 404 x 111	12.32 x 15.90 x 4.37	20	91	394 X 303 X 102	3140 A
BC-AL-314018	313 x 404 x 181	12.32 x 15.90 x 7.12	20	161	394 X 303 X 167	3140 A

Aluminum Push Button Box

알루미늄 푸시버튼 박스
铸铝按钮盒

HOLE : Ø22, Ø25, Ø30 (1 ~ 4-HOLE)

FEATURE | 특성 | 特征

- Screw type, RAL7001
- This series has a pre-cut hole on the cover
- 스크류 타입, RAL 7001
- 커버에 홀 있는 제품
- 螺栓型, RAL7001
- 该系列盒盖有预先打好的孔



PUSH BUTTON HOLE

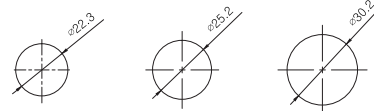

PUSH BUTTON HOLE SPACING

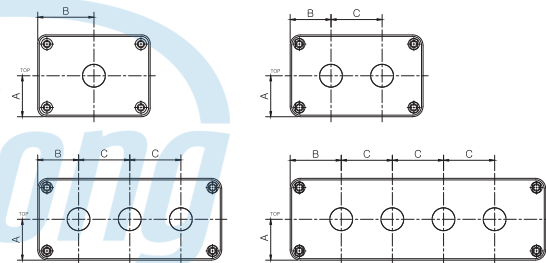

Model / 모델 / 型号	Hole	A	B	C
BC- AL- 08080□- □□01	1-Hole	37.5	40	-
BC- AL- 08130□- □□02	2-Hole	40	38	50
BC- AL- 08180□- □□03	3-Hole	40	38	50
BC- AL- 08250□- □□04	4-Hole	40	50	50

PUSH BUTTON BOX model name | 푸시버튼 박스 모델선정방법 | 按钮盒产品型号命名方法

BOXCO ① ② ③ ④ Ø ⑤

BC - AL - 08 08 06 - □ □ □ □ □ □

- ① Material / 재료 / 材质 - Aluminum diecasting
- ② Width / 가로 / 宽度(W)
- ③ Length / 세로 / 长度(L)
- ④ Height / 높이 / 高度(H) - 高度(H) Cover Included / 커버포함 / 含箱盖
- ⑤ Hole / 홀 개수 / 孔数

Model 모델 / 型号	Ø	Hole	Product model / 제품모델 / 产品型号				Inside depth(mm) 내부깊이 / 内部深度
			Outside dimension 외부 치수 / 外部尺寸				
			Size (W1xL1xH1/mm)	Size (W1xL1xH1/inch)	Cover (H3)	Base (H4)	
BC- AL- 080806- 2201	Ø22	1 HOLE	80 x 75 x 57	3.14 x 2.95 x 2.24	15	42	49
BC- AL- 080807- 2201			80 x 75 x 70	3.14 x 2.95 x 2.75	15	55	62
BC- AL- 081306- 2202		2 HOLE	80 x 125 x 57	3.14 x 4.92 x 2.24	15	42	50
BC- AL- 081307- 2202			80 x 125 x 70	3.14 x 4.92 x 2.75	15	55	63
BC- AL- 081806- 2203		3 HOLE	80 x 175 x 57	3.14 x 6.88 x 2.24	15	42	51
BC- AL- 081807- 2203			80 x 175 x 70	3.14 x 6.88 x 2.75	15	55	63
BC- AL- 082506- 2204		4 HOLE	80 x 250 x 57	3.14 x 9.84 x 2.24	15	42	50
BC- AL- 082507- 2204			80 x 250 x 70	3.14 x 9.84 x 2.75	15	55	63
BC- AL- 080806- 2501	Ø25	1 HOLE	80 x 75 x 57	3.14 x 2.95 x 2.24	15	42	49
BC- AL- 080807- 2501			80 x 75 x 70	3.14 x 2.95 x 2.75	15	55	62
BC- AL- 081306- 2502		2 HOLE	80 x 125 x 57	3.14 x 4.92 x 2.24	15	42	50
BC- AL- 081307- 2502			80 x 125 x 70	3.14 x 4.92 x 2.75	15	55	63
BC- AL- 081806- 2503		3 HOLE	80 x 175 x 57	3.14 x 6.88 x 2.24	15	42	51
BC- AL- 081807- 2503			80 x 175 x 70	3.14 x 6.88 x 2.75	15	55	63
BC- AL- 082506- 2504		4 HOLE	80 x 250 x 57	3.14 x 9.84 x 2.24	15	42	50
BC- AL- 082507- 2504			80 x 250 x 70	3.14 x 9.84 x 2.75	15	55	63
BC- AL- 080806- 3001	Ø30	1 HOLE	80 x 75 x 57	3.14 x 2.95 x 2.24	15	42	49
BC- AL- 080807- 3001			80 x 75 x 70	3.14 x 2.95 x 2.75	15	55	62
BC- AL- 081306- 3002		2 HOLE	80 x 125 x 57	3.14 x 4.92 x 2.24	15	42	50
BC- AL- 081307- 3002			80 x 125 x 70	3.14 x 4.92 x 2.75	15	55	63
BC- AL- 081806- 3003		3 HOLE	80 x 175 x 57	3.14 x 6.88 x 2.24	15	42	51
BC- AL- 081807- 3003			80 x 175 x 70	3.14 x 6.88 x 2.75	15	55	63
BC- AL- 082506- 3004		4 HOLE	80 x 250 x 57	3.14 x 9.84 x 2.24	15	42	50
BC- AL- 082507- 3004			80 x 250 x 70	3.14 x 9.84 x 2.75	15	55	63

Aluminum Terminal Block Box

알루미늄 단자박스
铸铝端子盒

5P ~ 50P

FEATURE | 특성 | 特征

- Screw type, RAL7001
- 스크류 타입, RAL 7001
- 螺栓型, RAL7001

SPECIFICATION | 사양 | 产品规格说明

- IP Rating / 방수, 방진 보호등급 / 防尘防水等级 | IP66/97
- IK Rating / 충격 테스트 / 冲击测试 | IK08
- Certification / 인증 / 认证 | TUV, CE



ALUMINUM TERMINAL BLOCK BOX

5PT

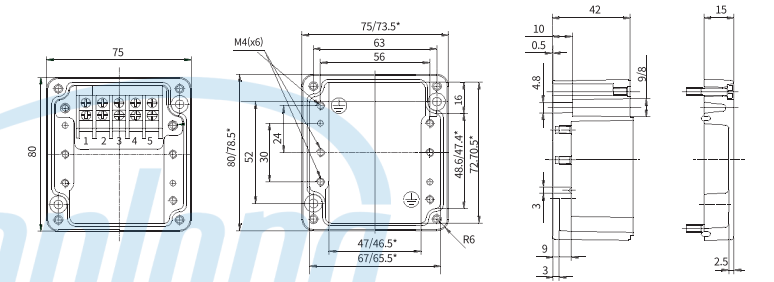

Model / 모델 / 型号	Size(WxLxH1/mm) / 사이즈 / 尺寸
BC-AL-5PT	80 x 75 x 57

6P

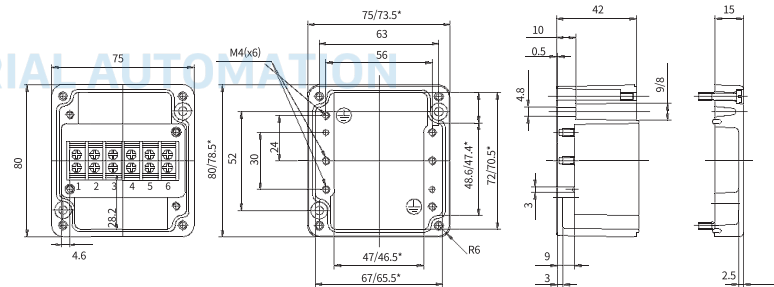

Model / 모델 / 型号	Size(WxLxH1/mm) / 사이즈 / 尺寸
BC-AL-6P	80 x 75 x 57

9P

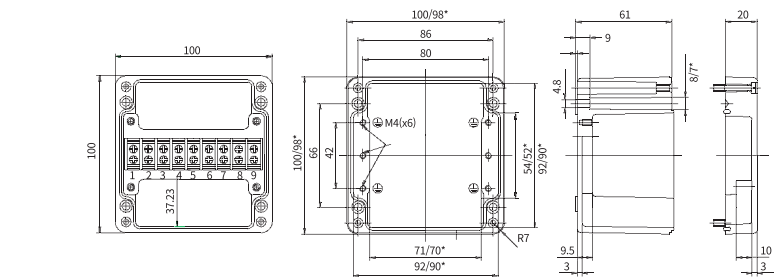

Model / 모델 / 型号	Size(WxLxH1/mm) / 사이즈 / 尺寸
BC-AL-9P	100 x 100 x 80

10PT

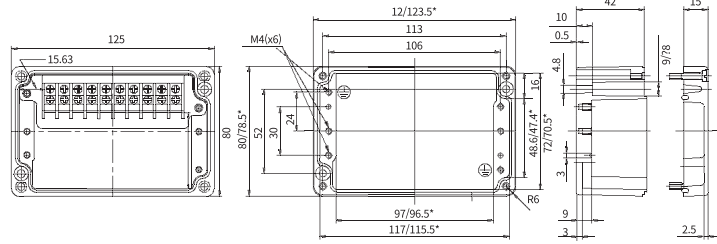

Model / 모델 / 型号

Size(W1xL1xH1/mm) / 사이즈 / 尺寸

BC- AL- 10PT

80 x 125 x 57

15PT

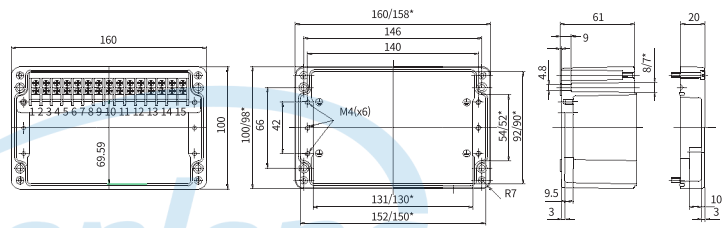

Model / 모델 / 型号

Size(W1xL1xH1/mm) / 사이즈 / 尺寸

BC- AL- 15PT

100 x 160 x 80

15P

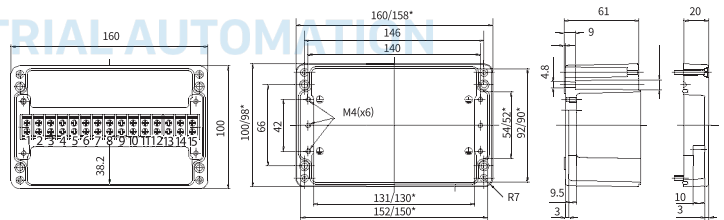

Model / 모델 / 型号

Size(W1xL1xH1/mm) / 사이즈 / 尺寸

BC- AL- 15P

100 x 160 x 80

20PT

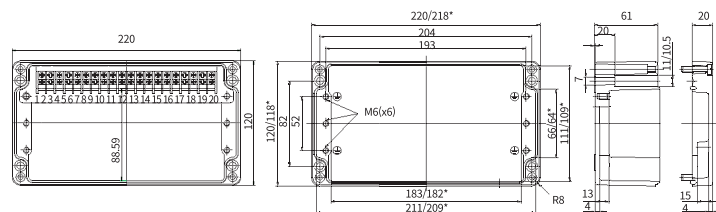

Model / 모델 / 型号

Size(W1xL1xH1/mm) / 사이즈 / 尺寸

BC- AL- 20PT

120 x 220 x 80

20P

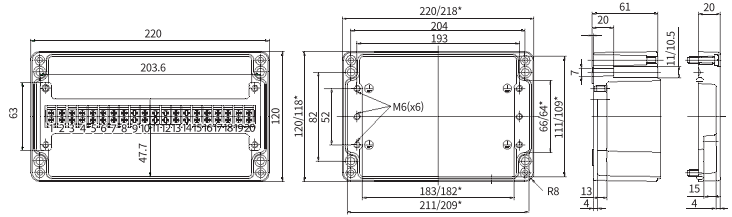
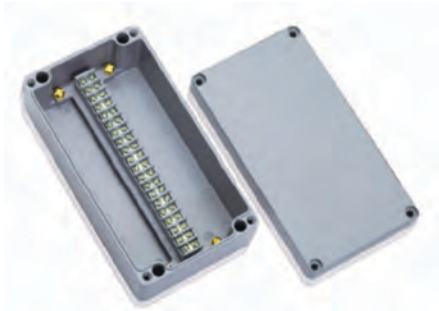

Model / 모델 / 型号	Size(W1xL1xH1/mm) / 사이즈 / 尺寸
BC-AL-20P	120 x 220 x 80

20PAS

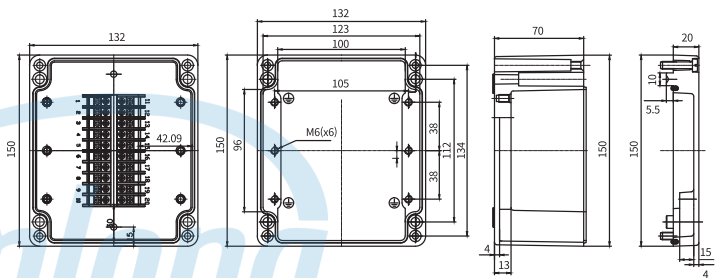

Model / 모델 / 型号	Size(W1xL1xH1/mm) / 사이즈 / 尺寸
BC-AL-20PAS	150 x 132 x 90

20PA

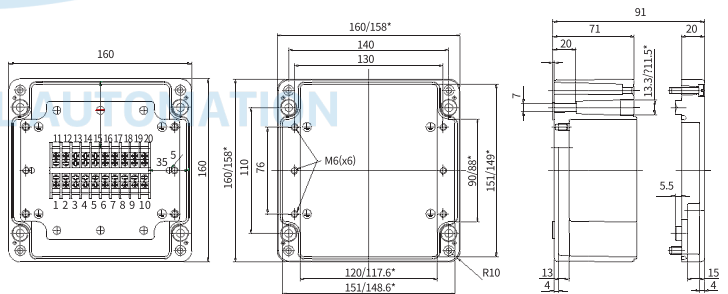
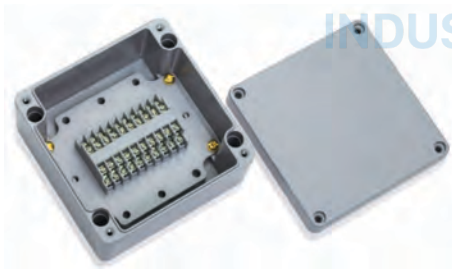

Model / 모델 / 型号	Size(W1xL1xH1/mm) / 사이즈 / 尺寸
BC-AL-20PA	160 x 160 x 90

20P2

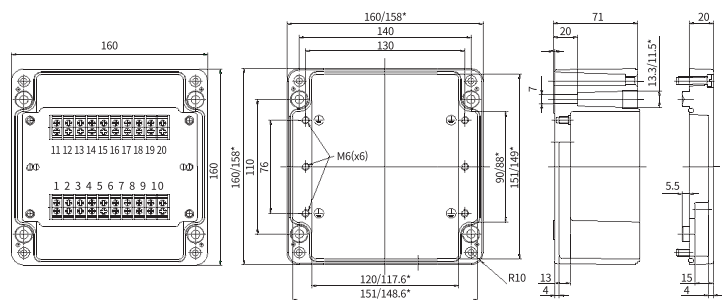

Model / 모델 / 型号	Size(W1xL1xH1/mm) / 사이즈 / 尺寸
BC-AL-20P2	160 x 160 x 90

25PT

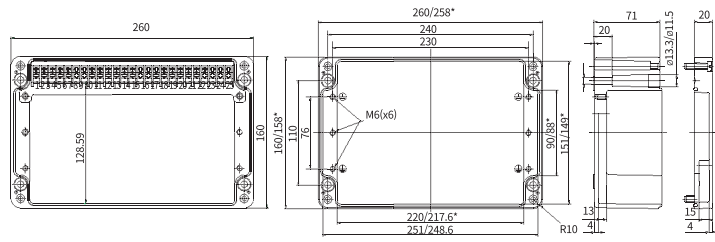

Model / 모델 / 型号	Size(W1xL1xH1/mm) / 사이즈 / 尺寸
BC- AL- 25PT	160 x 260 x 90

30PAS

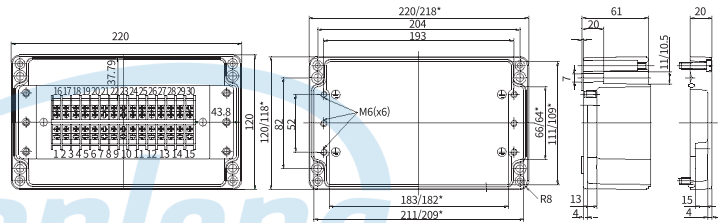
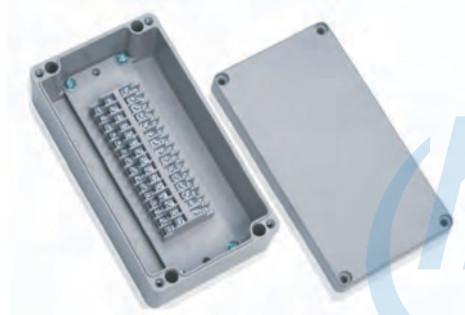

Model / 모델 / 型号	Size(W1xL1xH1/mm) / 사이즈 / 尺寸
BC- AL- 30PAS	120 x 220 x 80

30PA

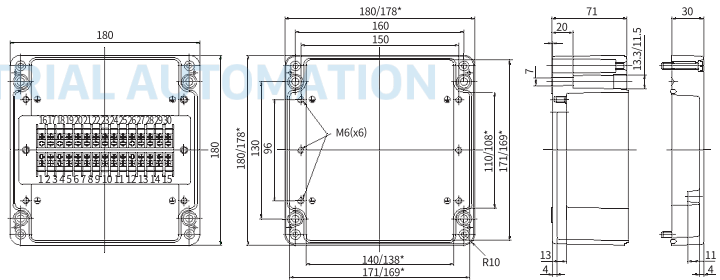
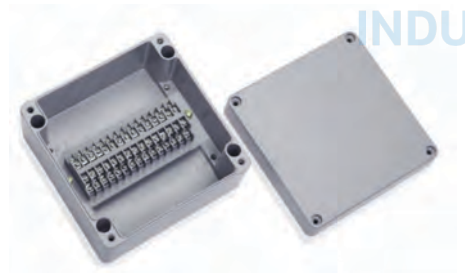

Model / 모델 / 型号	Size(W1xL1xH1/mm) / 사이즈 / 尺寸
BC- AL- 30PA	180 x 180 x 100

30P2

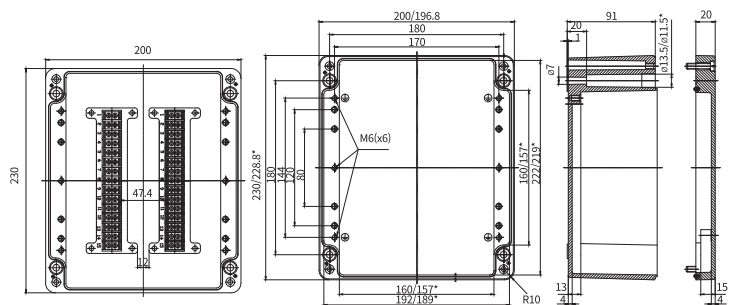
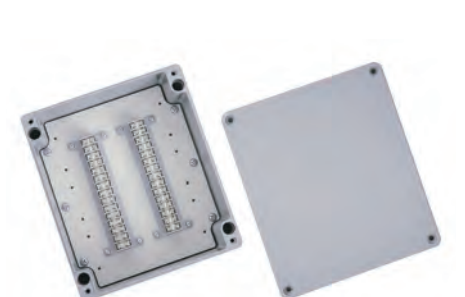

Model / 모델 / 型号	Size(W1xL1xH1/mm) / 사이즈 / 尺寸
BC- AL- 30P2	230 x 200 x 110

40PA

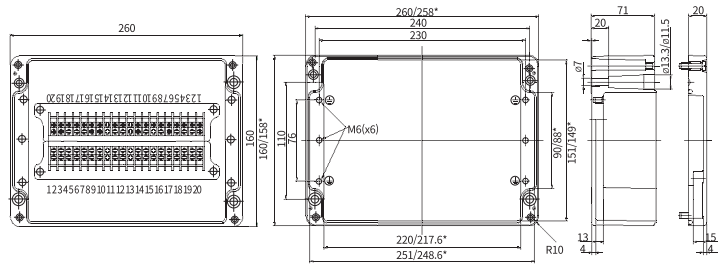
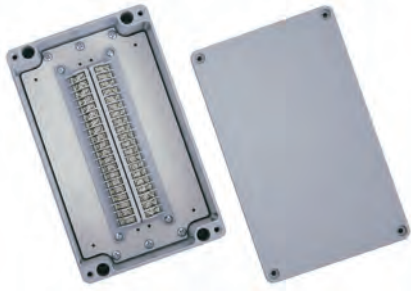

Model / 모델 / 型号	Size(W1xL1xH1/mm) / 사이즈 / 尺寸
BC- AL- 40PA	160 x 260 x 90

40P2

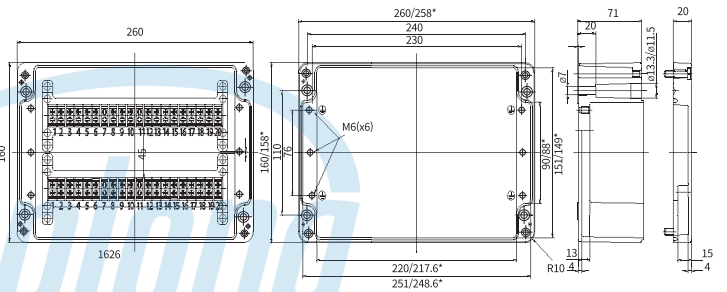
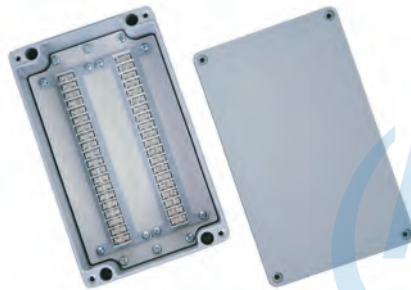

Model / 모델 / 型号	Size(W1xL1xH1/mm) / 사이즈 / 尺寸
BC- AL- 40P2	160 x 260 x 90

45P3

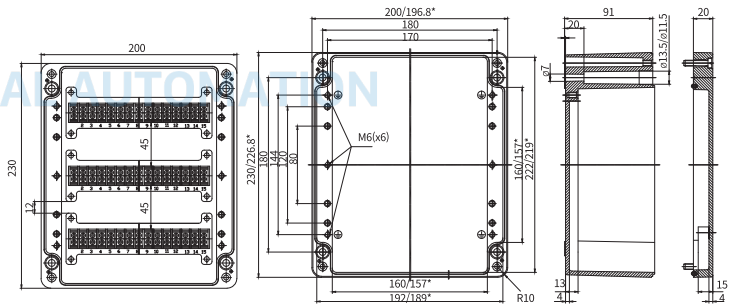
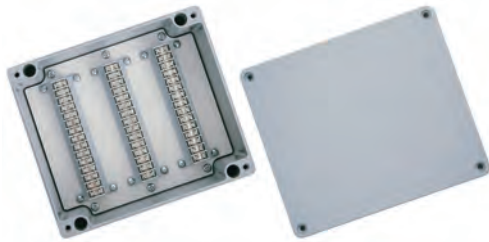

Model / 모델 / 型号	Size(W1xL1xH1/mm) / 사이즈 / 尺寸
BC- AL- 45P3	230 x 200 x 110

50PA

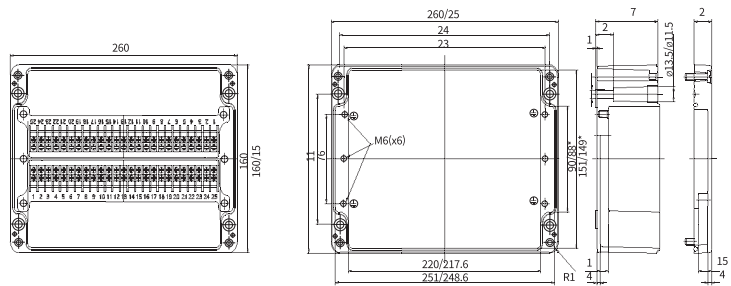

Model / 모델 / 型号	Size(W1xL1xH1/mm) / 사이즈 / 尺寸
BC- AL- 50PA	160 x 260 x 90

03

CABLE GLANDS, PLUGS & ACCESSORIES

케이블 그랜드, 플러그 및 액세서리
电缆防水接头, 插头和配件



Dual door
Cable glands, Plugs - PG Series
Cable glands, Plugs - M Series
Accessories
Conta Clip

이중도어
케이블 그랜드, 플러그 - PG 시리즈
케이블 그랜드, 플러그 - M 시리즈
액세서리
콘타클립

双层门
电缆防水接头, 插头 - PG 系列
电缆防水接头, 插头 - M 系列
配件
Conta Clip

• Dimensions and specifications are subject to change without notice.

• 규격 및 사양은 사전 예고 없이 변경될 수 있습니다.

• 厂家会在没有任何提前通知的情况下更改产品规格与样式。

Dual door

이중도어 双层门

FEATURE | 특성 | 特征

- Dual door is easy to open or close as it will be assembled with handle and hinge type.
- It is very strong as it is fixed with 4 supports and it has good external appearance.
- 이중도어는 손잡이와 힌지 방식으로 조립되어 개폐가 용이합니다.
- 4개의 지지대로 고정이 되어 매우 견고하고 내구성을 가지며, 외관이 미려합니다.
- 双层门系列采用安装把手与铰链的方式，方便开合。
- 采用4个支架点固定，非常牢固，外型美观大方。



ASSEMBLY OF DUAL DOOR KITS | 이중도어 조립도

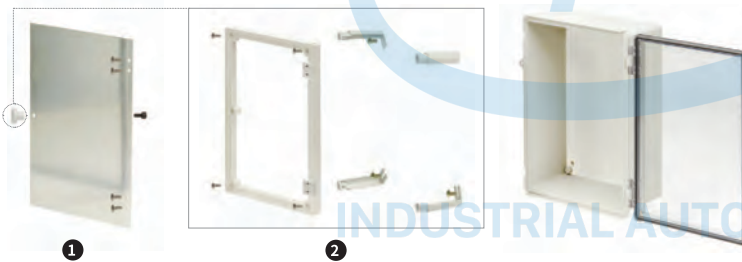

① Dual door aluminium plate

알루미늄 중판
铝板中门

② Dual door (Frame, support, hinge, handle Incl.)

이중도어 (프레임, 지지대, 힌지, 핸들 포함)
双层门 (包括框架, 支柱, 铰链, 把手, 安装螺丝)

① + ② Dual door set

이중도어 세트
套装双层门用配件

Dual door applicable model / 이중도어 적용가능 제품 / 适用产品		Product model / 제품모델 / 产品型号		
Model 모델 / 型号	Size(mm) 사이즈 / 尺寸	② Dual door 이중도어 / 双层门系列	① Dual door aluminium plate 알루미늄 중판 / 铝板中门	① + ② Dual door set 이중도어 세트 / 套装双层门用配件
BC- □□P- 203013	200 x 300 x 130	BC- F203013	BC- FA2030	BC- FA203013
BC- □□P- 203015	200 x 300 x 150	BC- F203015	BC- FA2030	BC- FA203015
BC- □□P- 203018	200 x 300 x 180	BC- F203018	BC- FA2030	BC- FA203018
BC- □□P- 253515	250 x 350 x 150	BC- F253515	BC- FA2535	BC- FA253515
BC- □□P- 253518	250 x 350 x 180	BC- F253518	BC- FA2535	BC- FA253518
BC- □□P- 282813	280 x 280 x 130	BC- F282813	BC- FA2828	BC- FA282813
BC- □□P- 283813	280 x 380 x 130	BC- F283813	BC- FA2838	BC- FA283813
BC- □□P- 303015	300 x 300 x 150	BC- F303015	BC- FA3030	BC- FA303015
BC- □□P- 303018	300 x 300 x 180	BC- F303018	BC- FA3030	BC- FA303018
BC- □□P- 304015	300 x 400 x 150	BC- F304015	BC- FA3040	BC- FA304015
BC- □□P- 304018	300 x 400 x 180	BC- F304018	BC- FA3040	BC- FA304018
BC- □□P- 354516	350 x 450 x 160	BC- F354516	BC- FA3545	BC- FA354516
BC- □□P- 354520	350 x 450 x 200	BC- F354520	BC- FA3545	BC- FA354520
BC- □□P- 405016	400 x 500 x 160	BC- F405016	BC- FA4050	BC- FA405016
BC- □□P- 405020	400 x 500 x 200	BC- F405020	BC- FA4050	BC- FA405020
BC- □□P- 406018	400 x 600 x 180	BC- F406018	BC- FA4060	BC- FA406018
BC- □□P- 406023	400 x 600 x 230	BC- F406023	BC- FA4060	BC- FA406023
BC- □□P- 506018	530 x 630 x 185	BC- F506018	BC- FA5060	BC- FA506018
BC- □□P- 506025	530 x 630 x 255	BC- F506025	BC- FA5060	BC- FA506025
BC- □□H- 405020	400 x 500 x 200	BC- F405020	BC- FA4050	BC- FA405020
BC- □□H- 406023	400 x 600 x 230	BC- F406023	BC- FA4060	BC- FA406023

Cable Glands, Plugs - PG Series

케이블 그랜드, 플러그 - PG 시리즈
电缆防水接头, 插头 - PG 系列

- Dimensions and specifications are subject to change without notice.
- 규격 및 사양은 사전 예고 없이 변경될 수 있습니다.
- 厂家会在没有任何提前通知的情况下更改产品规格与样式。

BC- PG | CABLE GLAND

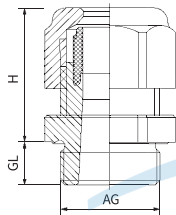

FEATURE | 특성 | 特征

- Material / 재질 / 材质 | PA
- Hermetic seal / 밀봉 씬 / 密封圈 | NBR
- Washer / 와샤 / 平垫 | NBR
- Color / 색상 / 颜色 | Grey, Black, Dark grey
- IP Rating / 방수, 방진 보호등급 / 防尘防水等级 | IP66/67

Model No.			Thread	Cable Ø (mm)	H (mm)	GL (mm)	Wrench (mm)	AG (mm)
Grey	Dark Grey	Black						
BC-PG7-G	BC-PG7-D	BC-PG7-B	PG7	4~6.5	19	9	16	12.5
BC-PG9-G	BC-PG9-D	BC-PG9-B	PG9	4.5~8.5	24	9	19	15.2
BC-PG11-G	BC-PG11-D	BC-PG11-B	PG11	5~10	25	9	22	18.6
BC-PG13.5-G	BC-PG13.5-D	BC-PG13.5-B	PG11	6~11	27	10	24	20.4
BC-PG16-G	BC-PG16-D	BC-PG16-B	PG16	8~13	29	10	27	22.5
BC-PG19-G	BC-PG19-D	BC-PG19-B	PG19	12~15	30	10	28	24
BC-PG21-G	BC-PG21-D	BC-PG21-B	PG21	13~18	35	12	33	28.3
BC-PG25-G	BC-PG25-D	BC-PG25-B	PG25	16~21	33	12	35	30
BC-PG29-G	BC-PG29-D	BC-PG29-B	PG29	18~25	41	12	42	37
BC-PG36-G	BC-PG36-D	BC-PG36-B	PG36	23~32	47	15	52	47
BC-PG42-G	BC-PG42-D	BC-PG42-B	PG42	30~38	50	18	60	54
BC-PG48-G	BC-PG48-D	BC-PG48-B	PG48	37~44	54	18	68	59.3
BC-PG63-G	BC-PG63-D	BC-PG63-B	PG63	42~51	59	30	77	70

BC- PG- L | LONG CABLE GLAND

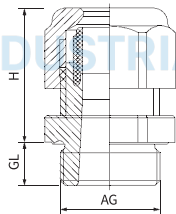

FEATURE | 특성 | 特征

- Material / 재질 / 材质 | PA
- Hermetic seal / 밀봉 씬 / 密封圈 | NBR
- Washer / 와샤 / 平垫 | NBR
- Color / 색상 / 颜色 | Grey
- IP Rating / 방수, 방진 보호등급 / 防尘防水等级 | IP66/67

Model No.	Thread	Cable Ø (mm)	H (mm)	GL (mm)	Wrench (mm)	AG (mm)
BC-PG7L-G	PG7	4~6.5	19	15	16	12.5
BC-PG9L-G	PG9	4.5~8.5	24	15	19	15.2
BC-PG11L-G	PG11	5~10	25	15	22	18.6
BC-PG13.5L-G	PG13.5	6~11	27	15	24	20.4
BC-PG16L-G	PG16	8~13	29	15	27	22.5
BC-PG21L-G	PG21	13~18	35	15	33	28.3
BC-PG29L-G	PG29	18~25	41	15	42	37
BC-PG36L-G	PG36	23~32	47	18	52	47
BC-PG42L-G	PG42	30~38	50	20	60	54
BC-PG48L-G	PG48	37~44	54	20	68	59.3

BC- BP- PG | BEND PROOF CABLE GLAND

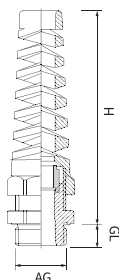

FEATURE | 특성 | 特征

- Material / 재질 / 材质 | PA
- Hermetic seal / 밀봉 씬 / 密封圈 | NBR
- Washer / 와샤 / 平垫 | NBR
- Color / 색상 / 颜色 | Grey

Model No.	Thread	Cable Ø (mm)	H (mm)	GL (mm)	Wrench (mm)	AG (mm)
BC-BP-PG7	PG7	4~6.5	59	9	16	12.5
BC-BP-PG9	PG9	4.5~8.5	68	9	19	15.2
BC-BP-PG11	PG11	5~10	74	9	23	18.6
BC-BP-PG13.5	PG13.5	6~12	90	9	24	20.4
BC-BP-PG16	PG16	10~14	100	10	27	22.5
BC-BP-PG21	PG21	13~18	104	12	33	28.3

BC- BP- PG- L | LONG BEND PROOF CABLE GLAND

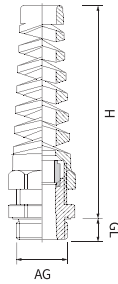

Model No. Grey	Thread	Cable Ø (mm)	H (mm)	GL (mm)	Wrench (mm)	AG (mm)
BC- BP- PG7L- G	PG7	4~6.5	59	15	16	12.5
BC- BP- PG9L- G	PG9	4.5~8.5	68	15	19	15.2
BC- BP- PG11L- G	PG11	5~10	74	15	23	18.6
BC- BP- PG13.5L- G	PG13.5	6~11	78	15	24	20.4
BC- BP- PG16L- G	PG16	8~13	82	15	27	22.5
BC- BP- PG21L- G	PG21	13~18	104	15	33	28.3

FEATURE | 특성 | 特征

- Material / 재질 / 材质 | PA
- Hermetic seal / 밀봉 씬 / 密封圈 | NBR
- Washer / 와셔 / 平垫 | NBR
- Color / 색상 / 颜色 | Grey

BC- MPG | METAL CABLE GLAND

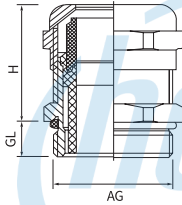

Model No.	Thread	Cable Ø (mm)	H (mm)	GL (mm)	Wrench (mm)	AG (mm)
BC- MPG7	PG7	4~7	15	6	14	12.5
BC- MPG9	PG9	5~8	19	7	18	15.2
BC- MPG11	PG11	6~10	20	8	20	18.6
BC- MPG13.5	PG13.5	6~12	22	9	22	20.4
BC- MPG16	PG16	7~14	21	9	24	22.5
BC- MPG19	PG19	9~16	23.5	9	27	24
BC- MPG21	PG21	13~18	24	9	30	28.3
BC- MPG25	PG25	16~22	27	11	34	32
BC- MPG29	PG29	14~24	31	10	40	37
BC- MPG36	PG36	25~32	35	10	50	47
BC- MPG42	PG42	32~38	36	14	58	54
BC- MPG48	PG48	34~44	39	12	64	59.3
BC- MPG63	PG63	43~52	40	15	76	70

FEATURE | 특성 | 特征

- Material / 재질 / 材质 | Nickel-plated brass
- Fixture pack / 고정부 / 夹紧抓 | PA
- Hermetic seal / 밀봉 씬 / 密封圈 | NBR
- O-Ring / 오링 / O型圈 | NBR
- IP Rating / 방수, 방진 보호등급 / 防尘防水等级 | IP66/67

BC- MPG- L | LONG METAL CABLE GLAND

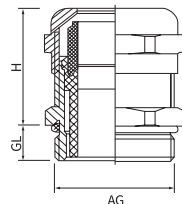

Model No.	Thread	Cable Ø (mm)	H (mm)	GL (mm)	Wrench (mm)	AG (mm)
BC- MPG7L	PG7	4~7	15	10	14	12.5
BC- MPG9L	PG9	5~8	19	10	18	15.2
BC- MPG11L	PG11	6~10	20	10	20	18.6
BC- MPG13.5L	PG13.5	6~12	22	10	22	20.4
BC- MPG16L	PG16	7~14	21	10	24	22.5
BC- MPG19L	PG19	9~16	23.5	12	27	24
BC- MPG21L	PG21	13~18	24	12	30	28.3
BC- MPG25-L	PG25	16~22	27	12	34	30
BC- MPG29-L	PG29	14~24	31	12	40	37
BC- MPG36L	PG36	25~32	35	12	50	47
BC- MPG42L	PG42	32~38	36	15	58	54
BC- MPG48L	PG48	34~44	39	15	64	59.3

FEATURE | 특성 | 特征

- Material / 재질 / 材质 | Nickel-plated brass
- Fixture pack / 고정부 / 夹紧抓 | PA
- Hermetic seal / 밀봉 씬 / 密封圈 | NBR
- O-Ring / 오링 / O型圈 | NBR
- IP Rating / 방수, 방진 보호등급 / 防尘防水等级 | IP66/67

BC- PKM- P | PKM METAL CABLE GLAND

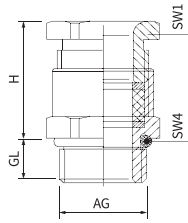

Model No.	Thread	Cable Ø (mm)	H (mm)	GL (mm)	Wrench (mm)	AG (mm)
BC- PKM- P7	PG7	6~8	16.1	6	15	12.5
BC- PKM- P9	PG9	8~10	17	7	17	15.2
BC- PKM- P11	PG11	10~12	18	7	20	18.6
BC- PKM- P13.5	PG13.5	12~14	19.5	7	24	20.4

FEATURE | 특성 | 特征

- Material / 재질 / 材质 | Nickel-plated brass
- Hermetic seal / 밀봉 씬 / 密封圈 | Modified rubber
- IP Rating / 방수, 방진 보호등급 / 防尘防水等级 | IP66

BC- HSK- EX- P | EX PLASTIC CABLE GLAND

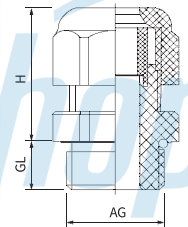

Model No.	Thread	Cable Ø (mm)	H (mm)	GL (mm)	Wrench (mm)	AG (mm)
BC- HSK- EX- P7	PG7	3~6.5	20	8	15	12.5
BC- HSK- EX- P9	PG9	4~8	22	8	19	15.2
BC- HSK- EX- P11	PG11	5~10	25	8	22	18.6
BC- HSK- EX- P13.5	PG13.5	6~12	26.5	9	24	20.4
BC- HSK- EX- P16	PG16	8~14	28	10	27	22.5
BC- HSK- EX- P21	PG21	13~18	31.5	11	33	28.3
BC- HSK- EX- P29	PG29	18~25	39	11	42	37
BC- HSK- EX- P36	PG36	22~32	48.5	13	53	47
BC- HSK- EX- P42	PG42	30~38	47.3	15	60	54
BC- HSK- EX- P48	PG48	37~44	47	15	65	59.3

FEATURE | 특성 | 特征

- Material / 재질 / 材质 | PA6
- Hermetic seal / 밀봉 씬 / 密封圈 | Modified rubber
- Washer / 와셔 / 平垫 | Modified rubber
- Color / 색상 / 颜色 | Grey
- IP Rating / 방수, 방진 보호등급 / 防尘防水等级 | IP68

BC- HSM- EX- P | EX METAL CABLE GLAND

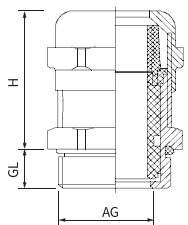

Model No.	Thread	Cable Ø (mm)	H (mm)	GL (mm)	Wrench (mm)	AG (mm)
BC- HSM- EX- P7	PG7	3~6.5	19	6	14	12.5
BC- HSM- EX- P9	PG9	4~8	21	7	17	15.2
BC- HSM- EX- P11	PG11	5~10	22.5	7	20	18.6
BC- HSM- EX- P13.5	PG13.5	6~12	23.5	7	22	20.4
BC- HSM- EX- P16	PG16	8~14	23.5	7	24	22.5
BC- HSM- EX- P21	PG21	13~18	26	7	30	28.3
BC- HSM- EX- P29	PG29	18~25	33	8	40	37
BC- HSM- EX- P36	PG36	22~32	38.5	9	50	47
BC- HSM- EX- P42	PG42	30~38	40	9	58	54
BC- HSM- EX- P48	PG48	37~44	41	10	65	59.3

FEATURE | 특성 | 特征

- Material / 재질 / 材质 | Nickel-plated brass
- Fixture pack / 고정부 / 夹紧抓 | PA
- Hermetic seal / 밀봉 씬 / 密封圈 | Modified rubber
- O-Ring / 오링 / O型圈 | Modified rubber
- IP Rating / 방수, 방진 보호등급 / 防尘防水等级 | IP68

BC- RG- PG | RUBBER GROMMET PG

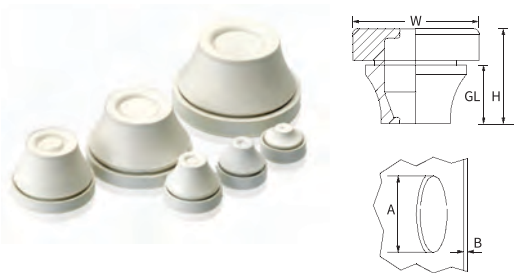

FEATURE | 특성 | 特征

- Material / 재질 / 材质 | EPDM
- IP Rating / 방수, 방진 보호등급 / 防尘防水等级 | IP67

Article No.	Thread	Cable Ø (mm)	A (mm)	B (mm)	H (mm)	GL (mm)	W (mm)
BC- RG- PG7	PG7	3~5	13	0.5~2	12.6	5.4	20
BC- RG- PG9	PG9	5~7	16	1~4	17.8	10.3	21
BC- RG- PG11	PG11	7~10	19	1~4	19.8	12.7	24
BC- RG- PG16	PG16	10~14	23	1~4	21.6	14.7	28
BC- RG- PG21	PG21	14~20	29	1~4	24.6	17.6	35
BC- RG- PG29	PG29	20~26	38	1~4	28.5	20	46
BC- RG- PG36	PG36	26~35	48	1~4	34.9	23.9	58

BC- SP- PG | NYLON SCREW PLUG

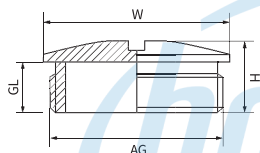

FEATURE | 특성 | 特征

- Material / 재질 / 材质 | PA

Model No.	Thread	H (mm)	GL (mm)	W (mm)	AG (mm)
BC- SP- PG7	PG7	12	9	16	12.5
BC- SP- PG9	PG9	13	8.5	19	15
BC- SP- PG11	PG11	12	9	22	18.6
BC- SP- PG13.5	PG13.5	14.5	11	25	20.4
BC- SP- PG16	PG16	14.5	11	27	22.5
BC- SP- PG21	PG21	14.5	11	33	28.3
BC- SP- PG29	PG29	16	11.5	44	37
BC- SP- PG36	PG36	18	13.5	55	46.7
BC- SP- PG42	PG42	18.5	13.5	62	53.7
BC- SP- PG48	PG48	19.5	14.5	68	59

INDUSTRIAL AUTOMATION

BC- HP | HOLE PLUG

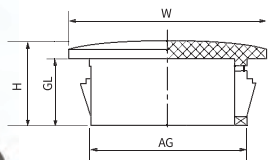

FEATURE | 특성 | 特征

- Material / 재질 / 材质 | PA

Model No.	H (mm)	GL (mm)	W (mm)	AG (mm)
BC- HP- 8	8	6.4	11.9	7.8
BC- HP- 10	10.5	8.9	13	9.5
BC- HP- 13	10.5	8.9	16.9	12.7
BC- HP- 16	10.5	8.9	19.8	15.9
BC- HP- 19	10.5	8.9	22.9	19
BC- HP- 22	11.5	9.9	24.9	22.2
BC- HP- 26	11.5	9.9	28.3	25.5
BC- HP- 30	11.5	9.9	34.2	30

BC- MSP- PG | METAL SCREW PLUG

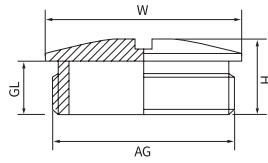

FEATURE | 특성 | 特征

- Material / 재질 / 材质 | Nickel-plated brass

Model No.	Thread	H (mm)	GL (mm)	W (mm)	AG (mm)
BC- MSP- PG7	PG7	9.7	7	14	12.2
BC- MSP- PG9	PG9	9.7	7	18	14.8
BC- MSP- PG11	PG11	10	7	20	18.2
BC- MSP- PG13.5	PG13.5	10.5	7	22	20
BC- MSP- PG16	PG16	10.5	7	24	22.2
BC- MSP- PG19	PG19	10.5	7	26	26.2
BC- MSP- PG21	PG21	11	7.8	30	27.9
BC- MSP- PG25	PG25	11	8	32	29.6
BC- MSP- PG29	PG29	13	9.5	40	36.5
BC- MSP- PG36	PG36	14	9.5	50	46.6
BC- MSP- PG42	PG42	15	9.5	57	53.5
BC- MSP- PG48	PG48	15	10	64	59.1

BC- DPM- P | HEXAGON PLUG

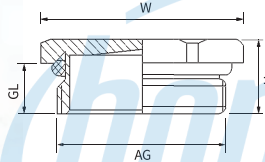

FEATURE | 특성 | 特征

- Material / 재질 / 材质 | Nickel-plated brass

Model No.	Thread	H (mm)	GL (mm)	W (mm)
BC- DPM- P7	PG7	8	5	14
BC- DPM- P9	PG9	9	6	17
BC- DPM- P11	PG11	9	6	20
BC- DPM- P13.5	PG13.5	9.5	6.5	22
BC- DPM- P16	PG16	9.5	6.5	24
BC- DPM- P21	PG21	11	7	30
BC- DPM- P29	PG29	12	8	39
BC- DPM- P36	PG36	15	9	50
BC- DPM- P42	PG42	16	10	57
BC- DPM- P48	PG48	16	10	64

INDUSTRIAL AUTOMATION

BC- MRH- PG | METAL REDUCER

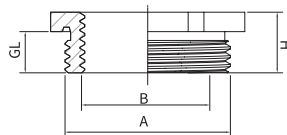

FEATURE | 특성 | 特征

- Material / 재질 / 材质 | Nickel-plated brass

Model No.	Thread A	Thread B	H (mm)	GL (mm)
BC- MRH- PG0907	PG9	PG7	9	6
BC- MRH- PG1107	PG11	PG7	9	6
BC- MRH- PG1109	PG11	PG9	9	6
BC- MRH- PG1309	PG13.5	PG9	9.5	6.5
BC- MRH- PG1609	PG16	PG9	9.5	6.5
BC- MRH- PG1611	PG16	PG11	9.5	6.5
BC- MRH- PG1613	PG16	PG13.5	9.5	6.5
BC- MRH- PG2111	PG21	PG11	10.3	7
BC- MRH- PG2113	PG21	PG13.5	10.3	7
BC- MRH- PG2116	PG21	PG16	10.3	7
BC- MRH- PG2916	PG29	PG16	11.5	8
BC- MRH- PG2921	PG29	PG21	11.5	8
BC- MRH- PG3621	PG36	PG21	12.5	9
BC- MRH- PG3629	PG36	PG29	12.5	9
BC- MRH- PG4229	PG42	PG29	13.5	10
BC- MRH- PG4236	PG42	PG36	13.5	10
BC- MRH- PG4836	PG48	PG36	14	10
BC- MRH- PG4842	PG48	PG42	14	10

Cable Glands, Plugs - M Series

케이블 그랜드, 플러그 - M 시리즈
 电缆防水接头, 插头 - M 系列

- Dimensions and specifications are subject to change without notice.
- 규격 및 사양은 사전 예고 없이 변경될 수 있습니다.
- 厂家会在没有任何提前通知的情况下更改产品规格与样式。

BC- M | CABLE GLAND

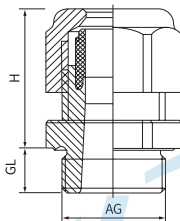

Model No.			Thread	Cable Ø (mm)	H (mm)	GL (mm)	Wrench (mm)	AG (mm)
Grey	Dark Grey	Black						
BC- M12- G	BC- M12- D	BC- M12- B	M12	4~6.5	20	9	16	12
BC- M16- G	BC- M16- D	BC- M16- B	M16	4.5~8.5	24	9	19	16
BC- M18- G	BC- M18- D	BC- M18- B	M18	5~10	25	9	22	18
BC- M20- G	BC- M20- D	BC- M20- B	M20	6~11	29	10	24	20
BC- M22- G	BC- M22- D	BC- M22- B	M22	8~13	29	10	27	22
BC- M24- G	BC- M24- D	BC- M24- B	M24	12~16	30	10	26	23.9
BC- M25- G	BC- M25- D	BC- M25- B	M25	13~18	33	12	33	25
BC- M27- G	BC- M27- D	BC- M27- B	M27	13~18	31	10	32	26.8
BC- M30- G	BC- M30- D	BC- M30- B	M30	16~21	39	12	35	30
BC- M32- G	BC- M32- D	BC- M32- B	M32	16~21	40	12	36	32
BC- M36- G	BC- M36- D	BC- M36- B	M36	18~25	42	12	40	36
BC- M40- G	BC- M40- D	BC- M40- B	M40	22~32	48	13	50	40
BC- M50- G	BC- M50- D	BC- M50- B	M50	32~38	49	13	60	49.5
BC- M63- G	BC- M63- D	BC- M63- B	M63	37~44	49	14	66	63.1

FEATURE | 특성 | 特征

- Material / 재질 / 材质 | PA
- Hermetic seal / 밀봉 씬 / 密封圈 | NBR
- Washer / 와샤 / 平垫 | NBR
- Color / 색상 / 颜色 | Grey, Black, Dark grey
- IP Rating / 방수, 방진 보호등급 / 防尘防水等级 | IP66/67

INDUSTRIAL AUTOMATION

BC- M- L | LONG CABLE GLAND

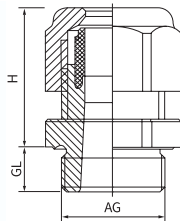

Model No.	Thread	Cable Ø (mm)	H (mm)	GL (mm)	Wrench (mm)	AG (mm)
Grey						
BC- M12L- G	M12	3~6.5	21	15	15	12
BC- M16L- G	M16	4.5~8.5	24	15	19	16
BC- M18L- G	M18	5~10	27	15	22	18
BC- M20L- G	M20	6~11	29	15	24	20
BC- M22L- G	M22	10~14	30	15	27	22
BC- M25L- G	M25	13~18	33	15	33	25
BC- M32L- G	M32	16~21	40	15	36	32
BC- M40L- G	M40	20~27	42	18	46	40
BC- M50L- G	M50	30~38	50	20	60	50
BC- M63L- G	M63	37~44	58	20	68	63

FEATURE | 특성 | 特征

- Material / 재질 / 材质 | PA
- Hermetic seal / 밀봉 씬 / 密封圈 | NBR
- Washer / 와샤 / 平垫 | NBR
- Color / 색상 / 颜色 | Grey
- IP Rating / 방수, 방진 보호등급 / 防尘防水等级 | IP66/67

BC- M- MULTI HOLE

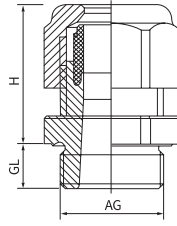

FEATURE | 특성 | 特征

- Material / 재질 / 材质 | PA
- Hermetic seal / 밀봉 씬 / 密封圈 | NBR
- Washer / 와샤 / 平垫 | NBR
- Color / 색상 / 颜色 | Black

Model No.	Thread	Cable Ø (mm)	H (mm)	GL (mm)	Wrench (mm)	AG (mm)
Black						
BC- M- 1 MULTI HOLE						
BC- 1H- M12- B	M12	4.5~8	25	9	19	12
BC- 1H- M16- B	M16	6~10	27	15	22	16
BC- 1H- M20- B	M20	9~14	33	15	27	20
BC- 1H- M25- B	M25	13~18	34	15	33	25
BC- 1H- M32- B	M32	18~25	41	15	42	32
BC- 1H- M40- B	M40	24~32	45	20	52	40
BC- 1H- M50- B	M50	31~41	51	22	62	50
BC- 1H- M63- B	M63	44~51	53	25	75	63
BC- 1H- M75- B	M75	56~66	56	25	92	75
BC- 1H- M90- B	M90	66~77	57	25	110	90
BC- M- 2 MULTI HOLE						
BC- 2H- M12- B	M12	1.5~3	25	9	19	12
BC- 2H- M16- B	M16	2~4	27	15	22	16
BC- 2H- M20- B	M20	3~6	33	15	27	20
BC- 2H- M25- B	M25	5~8	34	15	33	25
BC- 2H- M32- B	M32	7~11	41	15	42	32
BC- 2H- M40- B	M40	10~13	45	20	52	40
BC- M- 3 MULTI HOLE						
BC- 3H- M12- B	M12	1.5~2.5	25	9	19	12
BC- 3H- M16- B	M16	2~4	27	15	22	16
BC- 3H- M20- B	M20	3~5	33	15	27	20
BC- 3H- M25- B	M25	4.5~7	34	15	33	25
BC- 3H- M32- B	M32	7~10	41	15	42	32
BC- 3H- M40- B	M40	9~12	45	20	52	40
BC- M- 4 MULTI HOLE						
BC- 4H- M12- B	M12	1.5~2.5	25	9	19	12
BC- 4H- M16- B	M16	1.5~3	27	15	22	16
BC- 4H- M20- B	M20	2.5~4.5	33	15	27	20
BC- 4H- M25- B	M25	4~6	34	15	33	25
BC- 4H- M32- B	M32	8~9	41	15	42	32
BC- 4H- M40- B	M40	8~11	45	20	52	40
BC- M- 5 MULTI HOLE						
BC- 5H- M16- B	M16	1~2.5	27	15	22	16
BC- 5H- M20- B	M20	2~4	33	15	27	20
BC- 5H- M25- B	M25	3.5~5.5	34	15	33	25
BC- 5H- M32- B	M32	5.5~8	41	15	42	32
BC- 5H- M40- B	M40	7~9.5	50	20	52	40
BC- M- 6 MULTI HOLE						
BC- 6H- M16- B	M16	1~2	27	15	22	16
BC- 6H- M20- B	M20	1.5~3	33	15	27	20
BC- 6H- M25- B	M25	2.5~4.5	34	15	33	25
BC- 6H- M32- B	M32	5~7	41	15	42	32
BC- 6H- M40- B	M40	6~8	45	20	52	40

BC- BP- M | BEND PROOF CABLE GLAND

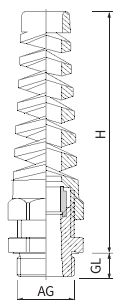

FEATURE | 특성 | 特征

- Material / 재질 / 材质 | PA
- Hermetic seal / 밀봉 씬 / 密封圈 | NBR
- Washer / 와샤 / 平垫 | NBR
- Color / 색상 / 颜色 | Grey

Model No.	Thread	Cable Ø (mm)	H (mm)	GL (mm)	Wrench (mm)	AG (mm)
BC- BP- M12- G	M12	4~6.5	60	9	16	12
BC- BP- M16- G	M16	4~8	63	8	19	16
BC- BP- M18- G	M18	5~10	78	8	21	18
BC- BP- M20- G	M20	6~12	90	9	23	20
BC- BP- M22- G	M22	8~13	82	10	27	22
BC- BP- M25- G	M25	13~18	114	10	32	25

BC- BP- M- L | LONG BEND PROOF CABLE GLAND

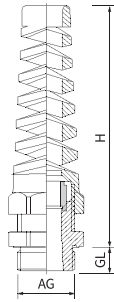

Model No.	Thread	Cable Ø (mm)	H (mm)	GL (mm)	Wrench (mm)	AG (mm)
BC- BP- M12L- G	M12	4~6.5	60	15	16	12
BC- BP- M16L- G	M16	4.5~8.5	68	15	19	16
BC- BP- M18L- G	M18	5~10	73	15	23	18
BC- BP- M20L- G	M20	6~11	82	15	24	20
BC- BP- M22L- G	M22	8~13	82	15	27	22
BC- BP- M25L- G	M25	13~18	105	15	33	25

FEATURE | 특성 | 特征

- Material / 재질 / 材质 | PA
- Hermetic seal / 밀봉 씬 / 密封圈 | NBR
- Washer / 와샤 / 平垫 | NBR
- Color / 색상 / 颜色 | Grey

BC- MM | METAL CABLE GLAND

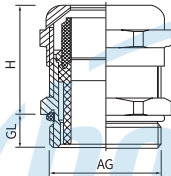

Model No.	Thread	Cable Ø (mm)	H (mm)	GL (mm)	Wrench (mm)	AG (mm)
BC- MM12	M12	4~7	15	6	14	12
BC- MM16	M16	5~8	19	7	18	16
BC- MM18	M18	6~10	20	8	20	18
BC- MM20	M20	6~12	22	8	22	20
BC- MM22	M22	7~14	21	9	24	22
BC- MM24	M24	12~15	23	7	27	23.7
BC- MM25	M25	7~14	21	9	27	25
BC- MM27	M27	13~18	24	7.5	30	27
BC- MM30	M30	13~18	23	8	32	30
BC- MM32	M32	16~22	27	11	34	32
BC- MM36	M36	14~24	31	10	40	36
BC- MM40	M40	22~30	37	9	45	39.4
BC- MM50	M50	32~38	37	9	58	49.2
BC- MM63	M63	34~44	39	13	68	63

FEATURE | 특성 | 特征

- Material / 재질 / 材质 | Nickel-plated brass
- Fixture pack / 고정부 / 夹紧抓 | PA
- Hermetic seal / 밀봉 씬 / 密封圈 | NBR
- O-Ring / 오링 / O型圈 | NBR
- IP Rating / 방수, 방진 보호등급 / 防尘防水等级 | IP66/67

BC- MM- L | LONG METAL CABLE GLAND

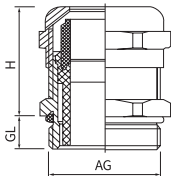

Model No.	Thread	Cable Ø (mm)	H (mm)	GL (mm)	Wrench (mm)	AG (mm)
BC- MM12L	M12	4~7	15	10	14	12
BC- MM16L	M16	5~8	19	10	18	16
BC- MM18L	M18	5~10	21	10	20	17.7
BC- MM20L	M20	6~12	22	10	22	20
BC- MM22L	M22	10~14	23	10	24	21.8
BC- MM24L	M24	12~15	23	10	27	23.7
BC- MM25L	M25	7~14	21	12	27	25
BC- MM27L	M27	13~18	26	12	30	26.7
BC- MM30L	M30	16~22	28	12	33	29.6
BC- MM32L	M32	16~22	27	14	34	32
BC- MM36L	M36	14~24	31	14	40	36
BC- MM40L	M40	23~28	30	15	45	40
BC- MM50L	M50	32~38	36	15	58	50
BC- MM63L	M63	34~44	39	15	68	63

FEATURE | 특성 | 特征

- Material / 재질 / 材质 | Nickel-plated brass
- Fixture pack / 고정부 / 夹紧抓 | PA
- Hermetic seal / 밀봉 씬 / 密封圈 | NBR
- O-Ring / 오링 / O型圈 | NBR
- IP Rating / 방수, 방진 보호등급 / 防尘防水等级 | IP66/67

BC- SP- M | NYLON SCREW PLUG

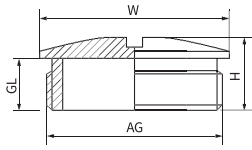

FEATURE | 특성 | 特征

- Material / 재질 / 材质 | PA
- Color / 색상 / 颜色 | Grey

Model No.	Thread	H (mm)	GL (mm)	W (mm)	AG (mm)
BC- SP- M12	M12	12	9	16	12
BC- SP- M16	M16	12	9	20	16
BC- SP- M18	M18	13	9	22	17.7
BC- SP- M20	M20	14.5	11	25	20
BC- SP- M22	M22	15	10.5	27	21.5
BC- SP- M24	M24	14.5	11	30	24
BC- SP- M25	M25	14.5	11	30	25
BC- SP- M27	M27	15.5	10.5	33	27
BC- SP- M32	M32	15	11	38	32
BC- SP- M40	M40	16	12	46	40
BC- SP- M50	M50	18	13.5	56	49.8
BC- SP- M63	M63	17	12	69	63

BC- MSP- M | METAL SCREW PLUG

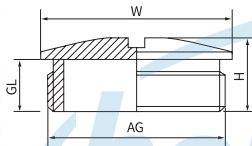

FEATURE | 특성 | 特征

- Material / 재질 / 材质 | Nickel-plated brass

Model No.	Thread	H (mm)	GL (mm)	W (mm)	AG (mm)
BC- MSP- M12	M12	9	6	14	11.7
BC- MSP- M16	M16	9	6	18	15.7
BC- MSP- M18	M18	10	6.5	20	17.4
BC- MSP- M20	M20	10.5	7.5	22	19.7
BC- MSP- M22	M22	10.5	7.5	24	21.5
BC- MSP- M24	M24	10	7	27	24
BC- MSP- M25	M25	10	7	28	25
BC- MSP- M27	M27	11	7	29.5	27
BC- MSP- M30	M30	12	8	32.5	30
BC- MSP- M32	M32	12	8	35	32
BC- MSP- M36	M36	12	8	38.5	36
BC- MSP- M40	M40	12.5	8	42	39.6
BC- MSP- M50	M50	14	10	52	49.7
BC- MSP- M63	M63	15	10.5	67	62.5

BC- MRH- M | METAL REDUCER

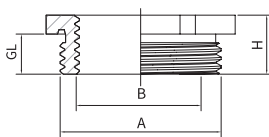

FEATURE | 특성 | 特征

- Material / 재질 / 材质 | Nickel-plated brass

Model No.	Thread A	Thread B	H (mm)	GL (mm)
BC- MRH- M1612	M16 x 1.5	M12 x 1.5	8	5
BC- MRH- M2012	M20 x 1.5	M12 x 1.5	9	6
BC- MRH- M2016	M20 x 1.5	M16 x 1.5	9	6
BC- MRH- M2516	M25 x 1.5	M16 x 1.5	10	7
BC- MRH- M2520	M25 x 1.5	M20 x 1.5	10	7
BC- MRH- M3216	M32 x 1.5	M16 x 1.5	11	8
BC- MRH- M3220	M32 x 1.5	M20 x 1.5	11	8
BC- MRH- M3225	M32 x 1.5	M25 x 1.5	11	8
BC- MRH- M4020	M40 x 1.5	M20 x 1.5	12	8
BC- MRH- M4025	M40 x 1.5	M25 x 1.5	12	8
BC- MRH- M4032	M40 x 1.5	M32 x 1.5	12	8
BC- MRH- M5025	M50 x 1.5	M25 x 1.5	13	9
BC- MRH- M5032	M50 x 1.5	M32 x 1.5	13	9
BC- MRH- M5040	M50 x 1.5	M40 x 1.5	13	9
BC- MRH- M6332	M63 x 1.5	M32 x 1.5	14	10
BC- MRH- M6340	M63 x 1.5	M40 x 1.5	14	10
BC- MRH- M6350	M63 x 1.5	M50 x 1.5	14	10

Accessories

액세서리
配件

VENT



FEATURE | 특성 | 特征

- It is easy to exhaust heat of inside box to outside.
- It is easy to install cooling pan inside the box.
- 박스내부의 발열을 외부로 쉽게 배출하게 해주는 부품입니다.
- 내부에 냉각팬이 쉽게 설치하게 되어 있습니다.
- 本产品有助于排出盒体内部的热空气。
- 本产品有助于在盒体内部安装冷却板。

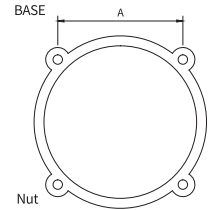

Material of nut for BC-CG-V60 / 80 is ABS /
BC-CG-V60 / 80 너트재질은 ABS임 / BC-CG-V60 / 80 螺母的材质是ABS

Model No.	Material	Thread Dimension (A)	Clamping range(mm)	Fan size(Ø)
BC-AG-V60	ABS	50 ± 0.3	63 ~ 65	60
BC-AG-V80	ABS	71.5 ± 0.3	88 ~ 90	80
BC-CG-V60	PC	50 ± 0.3	63 ~ 65	60
BC-CG-V80	PC	71.5 ± 0.3	88 ~ 90	80

Draw Latch

Material / 재질 / 材质 : SUS 304



Small size
소형 / 小型

S/H0811~1919



Medium
중형 / 中型

S/H1928~3040



Medium and large
중·대형 / 中·大型

H3545~4060

BC-L55

BC-L65

BC-L75

Hinge

Material / 재질 / 材质 : SUS 304



Small size
소형 / 小型

S/H0811~1919



Medium
중형 / 中型

S/H1928~3040



Medium and large
중·대형 / 中·大型

H3545~4060

BC-H55

BC-H65

BC-H75

SUS Bracket

Material / 재질 / 材质 : SUS 304



BC-B40



BC-B50



BC-B60

Plastic Bracket

Material / 재질 / 材质 : PC



BC-PB40



BC-PB50

Integral Lock (ABS)

Material / 재질 / 材质 : SUS 304 (For P series / P 시리즈 전용 / P系列专用)



P192810~353518



P354512~406023



P506018~608028

BC-PPK20-A

BC-PPK35-A

BC-PPK50-A

Integral Lock (PC)

Material / 재질 / 材质 : SUS 304 (For P series / P 시리즈 전용 / P系列专用)



P091207~172711,
P212110, P212113



P192810~353518



P354512~406023



P506018~608028

BC-PSK15-C

BC-PPK20-C

BC-PPK35-C

BC-PPK50-C

Plastic Lock

Material / 재질 / 材质 : Polyamide(PA)

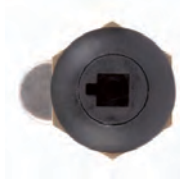

BC-PK

Lock

Material / 재질 / 材质 : SUS 304 etc.



BC-SK

Key Ring

Material / 재질 / 材质 : SUS 304



BC-K40

Plastic Mounting Plate

Material / 재질 / 材质 : ABS



P Plate



G Plate



C Plate

Steel Mounting Plate

Material / 재질 / 材质 : Steel (Zinc plating / 아연도금 / 镀锌)



S Plate



SQ Plate

Pole Mounting Bracket

Material / 재질 / 材质 : SUS 304



BC-PMB



Examples of use /
고객사용예 / 使用实例

Dual Door

Material / 재질 / 材质 : Aluminum / 알루미늄 / 铝



FA Plate

Material / 재질 / 材质 : ABS



Frame, Support, Hinge, Handle

Duct Ring

Material / 재질 / 材质 : Steel (Zinc plating / 아연도금 / 镀锌)



BC-D25S



BC-D25L



BC-D30S



BC-D30L

Cover Screw

Material / 재질 / 材质 : Polyamide(PA) CBG: ABS Color / ABS 색상 / ABS 颜色, CBB: PC Color / PC 색상 / PC 颜色



ABS	CBG10+	CBG20-	CBG20+	CBG28-	CBG28+	CBG35+	CBG50+
PC	CBB10+	-	CBB20+	CBB28-	CBB28+	CBB35+	CBB50+

Conta Clip

콘타클립

FEATURE | 특성 | 特征

- Material / 재질 / 材质 | Polyamide PA6.6, glass-fibre reinforced I TPE
- Color / 색상 / 颜色 | Black
- Flammability Rating / 난연성 / 阻燃等级 | UL94 V-0
- Temperature Range / 온도영역 / 温度范围 | - 40°C to + 120°C
- Halogen-free, Silicone-free
- Protection | IP66

KDS Click Cable Entry System | 모듈형 케이블 엔트리 시스템

혁신적인 케이블 엔트리 시스템

빠르다. 안전하다. 케이블 내부를 외부로!

KDS Click 케이블 엔트리 시스템은 개폐 장치 캐비닛, 하우징 및 기계를 위한 케이블 관리 솔루션으로 커넥터가 포함 또는 포함되지 않은 사전 조립 및 조립되지 않은 케이블에 대해 안전한 밀봉 및 변형 방지 기능을 제공합니다. KDS Click은 시간을 절약하고 최대한의 융통성을 제공합니다.

프레임에 부착

일체형 프레임은 쉽고 빠르게 벽에 부착할 수 있습니다.

보다 쉬운 서비스 작업을 위한 신속한 내부-외부로 어셈블리

요구사항이 변경되거나 서비스 작업을 수행하는 경우 프레임은 분해할 필요가 없습니다.

캡티브 씬

발포 프레임 개스킷은 조립 불량(가스켓 있음)을 방지하고 조립 공정의 속도를 높여줍니다.

씬의 간편한 분리

웨이브 컷 프로필은 설치가 쉽고 케이블 주위에 완벽한 착용감을 보장합니다.

케이블 조립 중 보증 무효 없음

커넥터를 분해하고 다시 연결할 필요가 없으므로 제조업체의 보증이 무효화되지 않습니다.

다양한 목적성 고밀도 조립 가능

1방향, 2방향 및 4방향 씬은 케이블 관리를 위한 탁월한 융통성을 제공합니다.

최적화된 웨어하우징을 통해 뛰어난 다기능성

프레임, 인레이 및 씬은 여러 가지 방법으로 결합될 수 있으므로 다재 다능한 구성 옵션을 다양하게 확보할 수 있습니다.

청각 피드백을 통한 안전하고 신속한 설치

"클릭" 소리는 인레이가 프레임에 올바르게 설치되었음을 확인시켜 줍니다.

통합된 변형 완화

씬의 안정된 결합은 DIN EN 62444에 따라 케이블의 변형 완화 메커니즘을 보장합니다.

아주 우수한 IP66 씬

다중 저항성, 테이퍼형 씬은 내부 및 외부 씬링 길을 갖추고 있습니다.

내부 잠금 프레임

옵션인 잠금 프레임은 공구를 사용하지 않고 씬을 밀어 낼 수 없도록 합니다.

-40°C ~ +120°C에서 사용 가능합니다.

재료에는 할로겐 또는 실리콘이 들어 있지 않아 다양한 용도에 적합합니다.

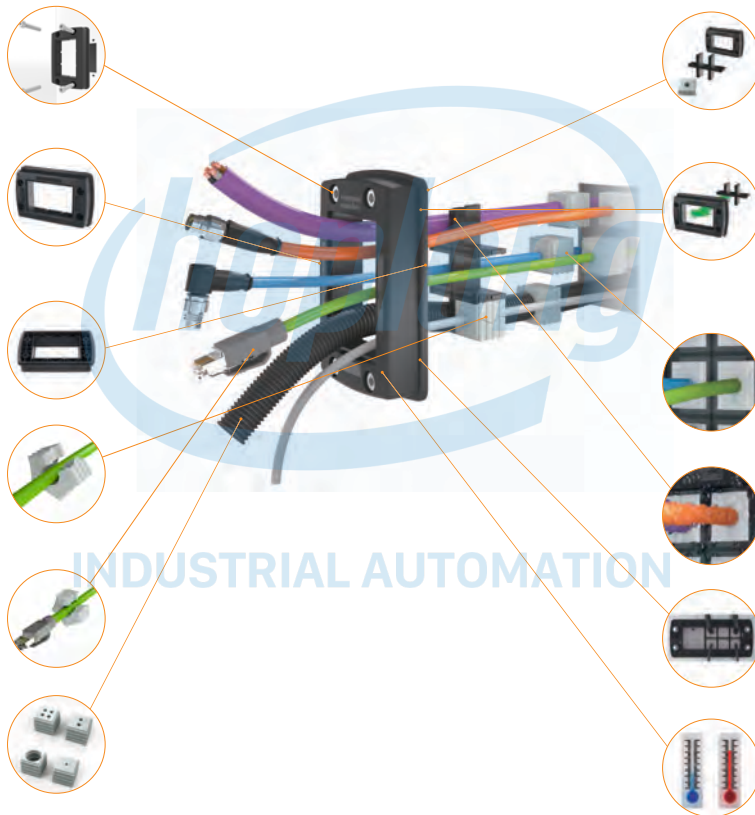

모듈형 시스템의 기본 구성 요소

프레임·인레이·씬·모듈형 디자인 / 3가지 기본 구성품 : 보다 다목적, 변화, 다양성을 제공합니다.



1. 프레임

2. 인레이

3. 씬



프레임 및 인레이



KDS-SR 1-4



KDS-SR 6/10



KDS-SR 8/16



KDS-SR 10/24

KDS Click | 분리형 케이블 그랜드

요구 사항에 맞는 전천후 "코너" 솔루션!

CONTA CLIP은 M20에서 M63까지 미터법에 의한 브레이크 아웃을 위해 플러그가 부착되거나 부착되지 않은 케이블용으로 분리형 케이블 그랜드를 제공합니다. 조립된 케이블 하네스로 유지 보수하거나 개량하는 경우 2 ~ 35 mm 직경의 케이블을 개폐 장치 캐비닛이나 하우징에 빠르고 안전하게 삽입하고 IP66에 따라 밀봉할 수 있습니다. 이 분리형 시스템은 빠르고 간단한 설치를 보장합니다. 슬릿형 씬에는 웨이브 컷 프로파일일 있어 확실한 씬링과 완벽한 부착을 보장합니다.

장착

케이블 그랜드를 장착하기 위해 공구가 필요하지 않습니다.

가변성

단 하나의 케이블 그랜드를 사용하여 최대 4개의 케이블을 연결할 수 있습니다.

보증 무효 없음: 조립된 케이블

커넥터를 분해하고 다시 연결할 필요가 없으므로 제조업체의 보증이 무효화되지 않습니다.

다양한 고밀도 조립 가능

1방향, 2방향 및 4방향 씬은 케이블 관리를 위한 탁월한 융통성을 제공합니다.



아주 우수한 IP66 씬

다중 저항성, 테이퍼형 씬은 내부 및 외부 씬링 길이를 갖추고 있습니다.

통합된 변형 완화

씬의 완벽한 견고함은 DIN EN 62444를 준수하는 케이블의 변형 방지 메커니즘을 보장합니다.

시설 가용성

케이블 그랜드와 잠금 너트는 분리 가능하므로 작동 중에 수리가 가능합니다.

-40 °C ~ +120°C에서 사용 가능합니다

할로겐 또는 실리콘을 포함하지 않는 재료라 다양한 응용 분야에 적합합니다.

INDUSTRIAL AUTOMATION

모듈형 시스템의 기본 구성 요소



1. 분할 케이블 그랜드 2. 분리형 로크너트 3. 씬



KDS-KV M20

KDS-KV M25

KDS-KV M32



KDS-KV M40

KDS-KV M50

KDS-KV M63



Example of application / 적용예 / 实例

CÔNG TY CỔ PHẦN CÔNG NGHỆ HỢP LONG

주식회사 박스코

본사(공장)영업부 부산광역시 사하구 신산로 134
T. 051-313-4401~7 F. 051-313-4408
부산전시판매장 부산광역시 사상구 광장로20번길 62(산업용품유통단지 서문 앞)
T. 051-902-4401 F. 051-902-4408
구로전시판매장 서울특별시 구로구 경인로53길 15 중앙유통단지 제 D1-1호
T. 02-2612-4401 F. 02-2612-4407
안양전시판매장 경기도 안양시 동안구 엘레스로 92 안양국제유통단지 13동 116, 117호
T. 031-451-4401 F. 031-451-4408

BOXCO Inc.

Head office and factory : 134, Sinsan-ro, Saha-gu, Busan, 49438, Korea
本社 · 工厂 : 釜山广域市沙下区新山路134
T. +82-51-313-4407 F. +82-51-316-4408



INDUSTRIAL AUTOMATION



Hotline: 1900.6536 - Website: HOPLONGTECH.COM