



Always with our customers

www.hynux.com

Always With Our Customers

WORLD LEADER IN CONTROL & MEASUREMENT

PRODUCT GUIDE



HANYOUNG NUX

Since 1972



SHANGHAI HANYOUNG ELECTRONICS CO., LTD

























PT. HANYOUNG ELECTRONIC INDONESIA





CONTENTS



Selection Table



	Temperature Controllers	22 page
	Recorders	65 page
	Digital Counter/Timers	68 page
	Analog Timers	79 page
	Multi Pulse Meters	84 page
	Panel Meters & Peripheral Devices	88 page
	Proximity Sensors	102 page
	Photo Sensors	115 page
	Rotary Encoders	131 page
	Thyristor Power Regulators	135 page
	Solid State Relays	143 page
	Power Supplies	155 page
	Control Switches / Combination Display Lights	158 page
	Power / Main / Cam Switches	163 page
	Limit Switches	167 page
	Micro Switches	169 page
	Foot / Mono Lever / Pendant Switches	170 page
	Sign Towers	174 page
	Wall Mounted Lights	179 page
	Turn Lights	181 page
	Warning Lights	182 page
	Power Buzzers, Terminal Blocks Fuse Holders, Control Boxes	184 page

Selection Table



Temperature Controllers



Type	Modular Programmable Temperature Controllers		2-Channel Programmable Temperature Controllers	
Model	TD510		TD500	TD300
Appearance				
Features	<ul style="list-style-type: none"> 2-channel control · Several alarm functions Multi input (RTD, TC, VDC) Communication function built-in (RS485) Detachable and expandable structure Digital Recorder function (internal memory, SD card storage) Digital input (DI) max. 32 contacts, digital output (DO) max. 32 contacts 5.7" Color TFT LCD touch screen 		<ul style="list-style-type: none"> 5.7" Color STN LCD touch screen 2-channel control · PID control Max. 100 patterns, 100 segments / pattern (total 2,400 segments) Several alarm functions (output: 4 contacts, operation: 20 types) Digital input (DI) 8 contacts, Digital output (DO) 16 contacts Communication function (RS485 or RS232 depending on the suffix code) 	<ul style="list-style-type: none"> 2-channel control · PID control 3.5" Color TFT LCD touch screen Max. 100 patterns, 100 segments/pattern (total 2,400 segments) Several alarm functions (output: 4 contacts, operation: 20 types) Digital input (DI) 8 contacts, Digital output (DO) 8 contacts Communication function (RS485 or RS232 depending on the suffix code) Data storage and parameter backup through SD card
Power voltage	100 - 240 V a.c.			
Accuracy	±0.15 % of FS		±0.1 % of FS	
Input	RTD, thermocouple, DC voltage			
Output	Relay output, SSR output, current output			
Control type	PID control/ ON-OFF control			
Page	22		23	24



Type	Modular Programmable Temperature & Humidity Controllers		Programmable Temperature & Humidity Controllers	
Model	TH510		TH500	TH300
Appearance				
Features	<ul style="list-style-type: none"> High-precision control Several alarm functions Smartphone remote monitoring function Communication function built-in (RS485) Detachable and expandable structure Temperature, humidity independent PID control Digital recorder function (internal memory, SD card storage) Digital input (DI) max. 32 contacts, digital output (DO) max. 32 contacts 5.7" Color TFT LCD touch screen 		<ul style="list-style-type: none"> 5.7" Color STN LCD touch screen High-precision control 100 patterns (total 6000 segments) Temperature, humidity independent PID control Several alarm functions Digital input (DI) 8 contacts, Digital output (DO) 20 contacts Communication function built-in (RS232, RS422/485) 	<ul style="list-style-type: none"> 3.5" Color TFT LCD touch screen High-precision control 100 patterns (total 2000 segments, 100 segments / pattern) Temperature, humidity independent PID control Several alarm functions Digital input (DI) 4 contacts, digital output (DO) 12 contacts Communication function (RS485 or RS232 depending on the suffix code)
Power voltage	100 - 240 V a.c.			
Accuracy	Temperature: ±0.1 % of FS / Humidity: ±1 % of FS		Temperature: ±0.2 % of FS / Humidity: ±2 % of FS	
Input	RTD, DC voltage			
Output	SSR output, current output			
Control type	PID control/ ON-OFF control			
Page	26		25	27

Type	Thermal Shock Test Controllers		Programmable Temperature Controllers	
Model	TS510		NP200	NP100
Appearance				
Features	<ul style="list-style-type: none"> Damper & elevator method support Multi input (RTD, TC, VDC) Communication function built-in (RS485) Detachable and expandable structure Digital Recorder function (internal memory, SD card storage) Digital input (DI) max. 32 contacts, digital output (DO) max. 32 contacts 5.7" Color TFT LCD touch screen 		<ul style="list-style-type: none"> Multi input / output, ±0.1 % high accuracy 30 patterns, 300 segments (1 pattern / 99 segments) Heating / cooling PID control 3-level PID selection (4 PID groups) PID auto-tuning mode 2 types Digital input (DI) 7 contacts, User output (UO) 10 contacts Communication function (RS485/422) 	<ul style="list-style-type: none"> 2 patterns / 20 segments (1 pattern / 10 segments) Fuzzy function, PID auto-tuning Group PID 3 types Alarm output/Time signal output 2 contacts each Digital input (DI) 3 contacts (RUN, RESET, HOLD) Communication function (RS485/422)
Power voltage	100 - 240 V a.c.			
Accuracy	RTD: ±0.1% of FS, thermocouple: ±0.15 % of FS		±0.1 % of FS	
Input	RTD, thermocouple, DC voltage			
Output	SSR output, current output		Relay output, SSR output, current output	
Control type	PID control/ ON-OFF control			
Page	30		28	29

Temperature Controllers



Type	LCD Temperature Controllers		Multi-Channel Digital Temperature Controllers	Modular Multi-Channel Temperature Controllers
Model	VX4		MC9	ML series
Appearance				
Features	<ul style="list-style-type: none"> Wide viewing angle LCD and white backlight Several input sensor support (TC, RTD, Voltage, Current) High precision (0.2 % accuracy) High speed sampling cycle (50 ms) IP65 (IEC 60529) front degree of protection Convenient parameter setting by USB cable. 		<ul style="list-style-type: none"> 4/8 channel control function Multi-memory function (ax 8 X 8) Heating / cooling control (4 channels) Digital input (DI) Communication function (RS232, RS485/422) 	<ul style="list-style-type: none"> Sampling cycle 50 ms 8 Event output contact units Max. 32 parallel connections (including ML-E) Unit power, communication connection by side connector Communication function (RS232C, RS485)
Power voltage	100 - 240 V a.c. 50/60 Hz			24 V d.c.
Accuracy	±0.2 % of FS ± 1 digit		±0.3 % of FS ±1 Digit	
Input	RTD, thermocouple, DC voltage, DC current		RTD, thermocouple, DC voltage	
Output	Relay output, SSR output, current output		Relay output, SSR output, current output, Triac output	Relay output, SSR output, current output
Control type	ON/OFF, PID control, 2DOF PID control		PID control / ON-OFF control	
Page	36		32	34



Type	Board Type Temperature Controllers	
Model	BX8	SM100
Appearance		
Features	<ul style="list-style-type: none"> Fuzzy function, PID auto-tuning 3 zone PID/ Group PID 3 types Ramp control function Heating / cooling control, Heater break alarm 3 set value type selection function by digital input (DI) Communication function (RS485) Convenient design (detachable case) 	<ul style="list-style-type: none"> Less installation space required with the board design 20 Channel integrated digital temperature controller ± 0.5% display accuracy of max. range Several alarm functions. (digital output 3 contacts) Communication function built-in (RS485/422, RS232C)
Power voltage	100 - 240 V a.c.	
Accuracy	±0.5% of FS ±1 Digit	±0.5 % of FS
Input	RTD, thermocouple, DC voltage	RTD, thermocouple
Output	Relay output, SSR output, current output	SSR output
Control type	PID control/ ON-OFF control	
Page	45	31





Type	Multi Input Temperature Controllers		
Model	AX series	KX series	MT100
Appearance			
Features	<ul style="list-style-type: none"> Multi Input High speed sampling cycle (0.1 sec) Installation depth: 63 mm Control output selectable: reverse operation/ direct operation Control loop break alarm (LBA) 	<ul style="list-style-type: none"> Multi Input Decimal point position selection 2-stage step function by external contact (KX45) Output operation selectable: reverse operation/direct operation PID auto-tuning 	<ul style="list-style-type: none"> Input 4 channels (control: 2 channels, monitoring: 2 channels) Temperature, pressure, current detection alarm functions Abnormal history display and saving functions Reverse phase detection (motor rotation direction) function Medium replenishment and suction function Communication function (RS485/422)
Power voltage	100 - 240 V a.c.		
Accuracy	±0.3 % of FS	0.5 % of FS	Temperature: ±0.3% of FS ±1 Digit Pressure: ±3% of FS ±1 Digit
Input	RTD, thermocouple (K, J, R, T, IEC 584-1)	RTD, thermocouple, DC voltage	RTD, thermocouple
Output	Relay output, SSR output, current output		Relay output, SSR output
Control type	PID control/ ON-OFF control		
Page	39	46	48

Selection Table



Temperature Controllers

Type	Multi Input / Output Temperature Controllers		Easy Operation Temperature Controllers
Model	NX series	HX series	DX series
Appearance			
Features	<ul style="list-style-type: none"> Fuzzy function, PID auto-tuning 3 zone PID/ Group PID 3 types Ramp control function Heating / cooling control, Heater break alarm 3 set value type selection function by digital input (DI) Communication function (RS485/422) 	<ul style="list-style-type: none"> Installation depth: 63 mm High speed sampling cycle (62.5 ms) Heater break alarm/ Retransmission output built-in Communication function (RS485)built-in Set value selection using digital input (DI) Heating/Cooling Control/Simultaneous Heating · Cooling Control Easy operation using the hot-key (SET + ▲) (auto-tuning, selectable from manual output) 	<ul style="list-style-type: none"> PID auto-tuning Direct/reverse operation internal selection High and Low alarm output Control loop break alarm (LBA) Decimal point display and high / low setting limitation Retransmission output
Power voltage	100 - 240 V a.c.		
Accuracy	0.5 % of FS	± 0.5 % of FS, ± 1.0 % of FS (refer to range and input code)	± 0.5 % of FS
Input	RTD, thermocouple, DC voltage		
Output	Relay output, SSR output, current output		
Control type	PID control/ ON-OFF control		
Page	40	38	50



Type	Easy Operation Temperature Controllers		Digital Temperature Controllers
Model	HY series	DF series	RS6
Appearance			
Features	<ul style="list-style-type: none"> Proportional control or ON / OFF control Convenient temperature setting Alarm setting (HY-8200S) Sharp digital display 	<ul style="list-style-type: none"> Proportional control or ON / OFF control Convenient temperature setting Auxiliary output setting (SUB) Sharp digital display Convenient 8 pin socket type (DF4) 	<ul style="list-style-type: none"> Heating/cooling control selection Alarm output 2 contacts For ON/OFF control only 0.1°C display Delay output time setting
Power voltage	110/220 V a.c. 50/60 Hz	DF2: 110/220 V a.c. 50/60 Hz DF4: 220 V a.c, 110 V a.c. 50/60 Hz (order separately)	12 V a.c.
Accuracy	±1 % of FS ±1 Digit	±1 % of FS ±1 Digit	±1 % of FS
Input	RTD, thermocouple, DC voltage	RTD, thermocouple	RTD, thermocouple, NTC exclusive product
Output	Relay output, SSR output, current output		Relay output
Control type	Proportional control, ON/OFF control		ON-OFF control
Page	52	53	59



Type	Temperature Controllers For Refrigerators		Cost-Effective Digital Temperature Controllers	Temperature Controllers For Greenhouses
Model	BR6A	BR6	ED6	HD6
Appearance				
Features	<ul style="list-style-type: none"> Heating/cooling control selection Alarm output, timer output selection ON/OFF, Proportional control selection 0.1°C / 1°C selection Delay output time setting IP65 (IEC 60529) front degree of protection Operation convenience improved with the set move key 	<ul style="list-style-type: none"> heating/cooling control selection Alarm output and timer output selection ON/OFF, Proportional control selection 0.1°C / 1°C selection Delay output time setting 	<ul style="list-style-type: none"> heating/cooling control selection Alarm output and timer output selection ON/OFF, Proportional control selection 0.1°C / 1°C selection Delay output time setting 	<ul style="list-style-type: none"> Greenhouse open / close motor control only 1-, 2-stage control operation according to set value Hysteresis setting by ON/OFF output Operation according to temperature and time setting 0.1 °C display function
Power voltage	100 - 240 V a.c./d.c.	100 - 240 V, 10-24 V a.c./d.c.	100 - 240 V a.c. ,10 - 24 V a.c./d.c.	100 - 240 V a.c.
Accuracy	±1 % of FS ±1 Digit		±0.5 % of FS ±1 Digit	±1 % of FS
Input	TH-570N (Hanyoung Nux exclusive sensor)	Thermistor (Hanyoung Nux exclusive sensor)	RTD, thermocouple	Thermistor (Hanyoung Nux exclusive sensor)
Output	Relay output, SSR output			Relay output
Control type	Proportional control, ON/OFF control		Proportional control, ON/OFF control	
Page	57	57	58	58

■ Temperature Controllers

Type	Analog Temperature Controllers	Deviation Indicating Temperature Controllers	Temperature Controllers Without Indicator
Model	HY-4500S / 5000	AF1	HY-2000, HY-1000, ND4
Appearance			
Features	<ul style="list-style-type: none"> Proportional control or ON/OFF control Convenient temperature setting Plug-in method (repair, inspection, exchange convenience) Burnout function (output OFF during sensor disconnection) 	<ul style="list-style-type: none"> Proportional control or ON/OFF control Convenient temperature setting Burnout function (output OFF during sensor disconnection) Control operation influence absent even during indicator breakdown 	<ul style="list-style-type: none"> Proportional control or ON/OFF control Convenient temperature setting Plug-in method (repair, inspection, exchange convenience) Burnout function (output OFF during sensor disconnection) Strong against vibrations and impacts, so it can be installed directly on the machine
Power voltage	110/220 V a.c.		
Accuracy	±2 % of FS ±1 Digit	±1 % of FS	Non-indicating
Input	RTD, thermocouple		RTD, thermocouple
Output	Relay output, SSR output, current output		Relay output
Control type	Proportional control, ON/OFF control		
Page	54	55	56

■ Temperature Indicators

Type	Digital Temperature Indicators		Large LED Temperature Indicators
Model	AT	BK3	HN100
Appearance			
Features	<ul style="list-style-type: none"> Common features: <ul style="list-style-type: none"> 0.5% high accuracy indicator Simple exclusive indication AT3: <ul style="list-style-type: none"> Character height 14.2 mm LED applied AT6: <ul style="list-style-type: none"> Free voltage (100 - 240 V a.c) Character height 11 mm LED applied 	<ul style="list-style-type: none"> 0.5 % high accuracy indicator Simple exclusive indication Power voltage 110/220 V a.c Character height 14.2/20.0 mm LED applied 	<ul style="list-style-type: none"> Large LED indication (character 34 X 56 mm) IP57 (IEC 60529) waterproof type Stainless external case Suitable for saunas, green houses, sport centers, Greenhouses
Power voltage	100 - 240 V a.c.	110/220 V a.c.	12 V d.c.
Accuracy	±0.5 % of FS		
Input	RTD, thermocouple	RTD, thermocouple, DC voltage, DC current	RTD, DC current
Page	60	61	64



Type	5-channel Temperature Indicators	Multi Input Temperature Indicators	Portable Thermometers
Model	TP3	BK6-M	D55
Appearance			
Features	<ul style="list-style-type: none"> Indicates 5 contact temperatures Temperature deviation compensation function in each channel Channel fixing/channel automatic switch selection Automatic switching time selection in each channel 	<ul style="list-style-type: none"> Multi Input (thermocouple, RTD, voltage · current) Retransmission output (4 - 20 mA d.c) Temperature unit selection Measured value correction function 	<ul style="list-style-type: none"> Temperature indication by large LCD Temperature unit selection Thermocouple selection function (K, J) Indication value hold, max. / min value indication Individual temperature and temperature difference indication with 2 contact measurement input
Power voltage	100 - 240 V a.c. 50/60 Hz		9 V d.c.
Accuracy	±0.5 % of FS ±1 Digit		
Input	RTD, thermocouple	Multi Input (19 types), thermocouple, RTD	Thermocouple
Page	62	63	98

Selection Table





■ Data Storage Devices

■ Floatless Level Switches



■ Fuse Holders

Type	Data Storage Devices	Floatless Level Switches	Fuse Holders
Model	EM310	FS - 3A	HY-ER3
Appearance			
Features	<ul style="list-style-type: none"> · 32 Mbyte data storage device · Convenient panel installation type (72 × 36 mm) · USB port for memory stick connection 	<ul style="list-style-type: none"> · Used for agricultural water, water treatment plant, sewage treatment plant, factory and several surface water control · Lightweight and easy to install · Operation status is indicated by LED 	<ul style="list-style-type: none"> · IP63 (IEC 60529) degree of protection · The PBT flame retardant provides robustness and reduces the fire risk · Body and cover are connected by hook coupling structure so they are easily detached by screwdriver
Power voltage	24 V d.c.	110 V a.c. / 220 V a.c.	-
Page	98	99	99

■ Converters





Type	Ethernet To Serial Converters	WiFi To Serial Converters	Communication Converters	Temperature / Humidity Converters
Model	HMCE-103	HMCW-103	CV310	CV250
Appearance				
Features	<ul style="list-style-type: none"> · Several connection interface support (RS232 / RS485 / RS422) · Open network protocol support · Up to 3 clients can be simultaneously connected 	<ul style="list-style-type: none"> · IEEE 802.11 b · DHCP support (available in dynamic IP environments) · Dipole antenna, SMA type antenna connection port · Host connection mode support (TCP server, TCP client, UDP) · RS232/RS485/RS422 · Security functions (Password, open, WEP 40, WEP 104, WPA-PSK, WPA2-PSK) 	<ul style="list-style-type: none"> · RS232 to RS485 / RS422 signal conversion · RS232 and RS485 / RS422 2 kV electrical insulation built-in protection device · RS485 Echo, Non-Echo function support · Excellent compatibility with fast transmission/reception switching speed · Max. 1.2 Km, 256 Node connection available 	<ul style="list-style-type: none"> · DIN rail and bolt fixing mounting method · Uniform with DC signal · Relative humidity calculation by dry bulb temperature and wet bulb temperature · Two-wire transmission line is simple. · Simple signal distribution (low output resistance) · Linear signal
Power voltage	5 V d.c.	9 V d.c.	5 V d.c.	-
Page	101	100	101	100

■ Recorders





Type	Touch Screen Recorders		2-channel temperature controllers & recorders
Model	GR2000	GR200	RT9N
Appearance			
Features	<ul style="list-style-type: none"> · Large high-definition screen: 12.1" 800 × 600 TFT-LCD · User note / save function · Fast DB integrated search · Various and abundant saving space (internal memory: 400 MByte (non-volatile), external memory: USB memory, SD CARD) · Smartphone remote monitoring function · RS485/422/ETHERNET 	<ul style="list-style-type: none"> · High-definition screen: 5.7" 640×480 TFT-LCD · Large memory: SD and SDHC card support (internal memory: 80 MB) · 3-language support: Korean, English, Chinese (simplified) · Data storage and parameter backup function with SD card · RS485/422/ETHERNET 	<ul style="list-style-type: none"> · Several alarm functions · Multi input/output · Communication function (RS485) · Free scale function · PID auto-tuning · Temperature record & control
Power voltage	100 - 240 V a.c.		
Accuracy	±0.15 % of FS ±1 Digit		±0.5 % of FS
Input	RTD, thermocouple, DC voltage		
Channels	6/12/18/24/30/36/42/48/54/60 channels	2/4/8/12 channels	1/2 channels
Contact outputs	16 contacts, 32 contacts	6 contacts, 12 contacts	Alarm: 2 contacts, Control output: 1 contact
Page	65	66	67



Selection Table

Counter / Timers

Type	LCD Counter / Timers		Digital Counter / Timers	Counter / Timers	LCD Digital Counters
Model	LC series		GE series	GF series	LC1
Appearance					
Features	<ul style="list-style-type: none"> Improved visibility with the wide viewing angle LCD and white display Pre-scale setting range expanded (0.00001 ~ 999999) 		<ul style="list-style-type: none"> NPN / PNP input selection Pre-scale setting 4 decimal places Addition and down display by CP1 and CP2 inputs Batch function built-in 	<ul style="list-style-type: none"> Counter & timer functions Pre-scale setting (GF7) 14 input operations, 16 output operations Decimal places setting 16 timer ranges (decimal / sexagesimal 8 types) NPN/PNP (voltage / non-voltage) input selection 	<ul style="list-style-type: none"> Compact LCD indicating total counter External power not needed with the built-in battery You can reuse the product by replacing the battery Small Power consumption and long battery life (about 7 years at room temperature) Non-voltage or voltage input IP66 (IEC 60529) degree of protection (front side)
Power voltage	100 - 240 V a.c.				Lithium battery built-in
Type	Preset method		Preset method, Indication only		Indication only
Control functions			Counter, Timer		Counter
Display digits			4 digits, 6 digits		8 digits (addition)
Setting stages			1-stage setting, 2-stage setting		-
Page	73		68		70



Timers



Type	LCD Timers	Digital Twin Timers		Digital Timers
Model	LT1	TT7H	TT4	TF4
Appearance				
Features	<ul style="list-style-type: none"> Compact LCD indicating total counter External power not needed with the built-in battery You can reuse the product by replacing the battery Long battery life with small power consumption (about 10 years at room temperature) Non-voltage or voltage input IP66 (IEC 60529) degree of protection (front side) 	<ul style="list-style-type: none"> Individual setting of ON time and OFF time Output operation control according to external START input signal Wide power specifications (100 - 240 V a.c. 50/60 Hz) 	<ul style="list-style-type: none"> Free voltage (100 - 240 V a.c. 50/60 Hz) Dual timer & twin timer functions (Can be used as 2 independent timers) Output operation control according to external input signal (START, RESET, INHIBIT) 	<ul style="list-style-type: none"> Simple functions, convenient setting Range selection with front side deep switch (2 types) Decimal or sexagesimal Relay or transistor output Free power (100 - 240 V a.c. 50/60 Hz, 24 - 60 V d.c.)
Power voltage	Lithium battery built-in	100 - 240 V a.c. (TT4), 220 V a.c. (TT7H)		100 - 240 V a.c.
Type	Indication only			
Control functions	Timer			
Display digits	8 digits (addition)	4 digits		
Time specs	-	0.01 s ~ 9999 hour		Refer to standard range
Page	71	75		76

Type	LCD Timers		LCD Weekly & Yearly Time Switches
Model	LT4 / LT4S	LF4N	LY series
Appearance			
Features	<ul style="list-style-type: none"> Bright and easy to view with the wide viewing angle LCD Time limit 1c, Instantaneous 1c + Time limit 1c, Time limit 2c, STAR + DELTA Minimum signal time selection (1 ms / 20 ms) Several time ranges (0.01 sec ~ 9999 hrs) Several operation modes (LT4: 7 operation modes, LT4S: 10 operation modes) One-shot output time setting (0.01 sec ~ 99.99 sec) Wide power specifications (24 - 240 V a.c. 50/60 Hz, 24 - 240 V d.c. dual usage) 	<ul style="list-style-type: none"> LCD display (displays several functions) Multi input ranges (10 types) Multi output operations (10 types) Bar graph over time display Reset, start and inhibit inputs Free voltage (24 - 240 V a.c./d.c. 50/60 Hz) 	<ul style="list-style-type: none"> Easy to check and change programs Automatic change of seasonal program according to season setting function It is possible to add the yearly program to the weekly program The holiday setting function can block the output during the selected holidays Embedded type and exposed type installations (it can be installed on DIN rail without base plate)
Power voltage	24 - 240 V a.c. 50/60 Hz, 24 - 240 V d.c.	24-240 V a.c./d.c.	
Display digits	4 digits		4 digits, 2 lines
Time specs	0.01 sec ~ 9999 hour	0.01 sec ~ 9990 hour	
Page	74	78	





Selection Table

■ Timers





Type	Timing Relays	ON-Delay Timers
Model	T21	T38N, T48N, T57N
Appearance		
Features	<ul style="list-style-type: none"> Timing Relay (time limit 4c) Dimensions: 21.4 (W) X 28 (H) mm Plug-in type (14 pins) Time range and operation mode customizable by the user Several time ranges (min/sec : 0.1 sec ~ 60 min, hrs: 0.3 hrs ~ 24 hrs) Multi operation mode (power ON delay, interval, flicker OFF start, flicker ON start) 	<ul style="list-style-type: none"> Time progress display using ON LED Several time ranges (7 types) Time unit selectable (hours, minutes, seconds) Several model configurations (5 types) Free voltage (24 - 240 V a.c./d.c. 50/60 Hz)
Power voltage	100 - 120 V a.c., 200 - 230 V a.c., 24 V d.c.	24 - 240 V a.c./d.c.
Time specs	0.1 s ~ 24 hour	0.01 s ~ 60 hour
Page	79	80





Type	Twin / Dual Timers	Analog Multi Timers	Star-Delta Timers
Model	TF62N, TF62D	MA4N	MA4SD
Appearance			
Features	<ul style="list-style-type: none"> Time progress display using ON LED Several time ranges (7 types) Time unit selectable (hours, minutes, seconds) Several model configurations (5 types) Free voltage (24 - 240 V a.c./d.c. 50/60 Hz) 	<ul style="list-style-type: none"> Output operation modes (6 types) Multi range (4 types) Time units (4 types) Reset, start and inhibit inputs Free voltage (24 - 240 V a.c./d.c. 50/60 Hz) 	<ul style="list-style-type: none"> 8-pin plug type High capacity motor start timer Star-delta contact outputs, Instantaneous contact outputs Wide power specifications (AC/DC dual usage) (100 - 240 V a.c. 50/60 Hz, 24 - 240 V d.c.)
Power voltage	24-240 V a.c./d.c.		100-240 V a.c.
Time specs	Time range selection (3 types)	Minimum spacing interval: 1 minute	1~300 s
Page	81	82	83

■ Multi Pulse Meters

Type	LCD Multi Pulse Meters	Small LCD Pulse Meters	Multi Pulse Meters	Multi Pulse Meters
Model	LP3	LP1	BP6	RP series
Appearance				
Features	<ul style="list-style-type: none"> Improved visibility with the wide viewing angle LCD and white display High-speed pulse measurement (50 KHz) 	<ul style="list-style-type: none"> Small LCD Pulse Meters Rotation speed / Frequency measurement 5-digit display available External power not needed with the built-in battery Non-voltage or free voltage input IP66 (IEC 60529) degree of protection (front side) 	<ul style="list-style-type: none"> Auto zero time setting Comparative output (HH,H,GO,L,LL) Start compensation timer function Max. value (5 types), min value (5 types) save Power outage compensation function (F9 mode) Max. 50 KHz 	<ul style="list-style-type: none"> Auto zero time setting Comparative output (HH, H, GO, L, LL) Start compensation timer function Max. value (5 types), min value (5 types) save Power outage compensation function (F9 mode) Max. 10 KHz input
Power voltage	100 - 240 V a.c.	Lithium battery built-in	100 - 240 V a.c., 24 - 60 V a.c. / d.c.	
Operation modes	Number of revolutions, frequency, speed, Moving speed, cycle, transit time, time difference, time width, measured length, interval, integration, absolute ratio, error ratio, density, error	Revolution speed, frequency	Number of revolutions, frequency, speed, Moving speed, cycle, transit time, time difference, time width, pulse width, pulse interval, integration counter, absolute ratio, error ratio, density, error	Number of revolutions, frequency, speed, Moving speed, cycle, transit time, time difference, time width, pulse width, pulse interval, integration counter
Input frequency	Contactless (max. 50 KHz, ON/OFF pulse width 10 us min), contact (max. 30 Hz, ON/OFF pulse width min. 16.6 ms)	-	50 KHz	10 KHz
Display cycle	0.05, 0.5, 1, 2, 4, 8 sec	-	0.05, 0.5, 1, 2, 4, 8 sec	
Output	Proportional control, ON/OFF control	-	Relay, transistor	Relay, transistor, retransmission
Page	86	87	84	85





■ Panel Meters

Type	Digital Wattmeters	Digital Power Factor Meters	Digital Multi Panel Meters	Digital Frequency Meters
Model	WM3	PF3	MP3 / MP6	MP3-4H / MP6-4H
Appearance				
Features	<ul style="list-style-type: none"> Effective power display by RMS measurement Converter not needed with the voltage and current measurement method Measuring range up to 220 V a.c. Several outputs (Relay 4 - 20 mA d.c. open collector) 	<ul style="list-style-type: none"> Power factor display by voltage and current measurement Single-phase 2-wire 220 V a.c. Display range $\pm(0.10 \sim 1.00)$ Several output specifications (Relay, 4 - 20 mA) 	<ul style="list-style-type: none"> RMS measurement Multi input range Wide display range, 4 digits (-1999 ~ 9999) 	<ul style="list-style-type: none"> Exclusive frequency meter Frequency measurement by AC voltage input signal Wide display range, 4 digits (-1999~9999)
Power voltage	100-240 V a.c.			
Display digits	-1999 ~ 9999	$\pm 0.10 \sim 1.00$	-1999 ~ 9999	
Functions	Wattmeter (W)	Power factor meter (COS ϕ), single-phase 2 W	Scaling	Frequency meter (Hz)
Input	Single-phase 2-wire 220 V a.c.	Current 5 A Max. 0-240 V a.c. Current transformer used when exceed 5A	Multi Input	Relay output
Output	Display only, 4 - 20 mA d.c. relay (HI, GO, LO), transistor, communication (RS485)		Relay (HI,GO,LO) transistor,4 - 20 mA d.c., communication (RS485) BCD (Except MP6), display only	Relay (HI, GO, LO), transistor, 4 - 20 mA d.c., communication (RS485), display only
Page	88	89	90	94





Type	Digital Voltmeter / Ammeters		Digital Scale Meters	Non-Power Scale Meters
Model	BS	BA1	HP3	HLP1
Appearance				
Features	<ul style="list-style-type: none"> Bright and clear LED display Cost-effective Max. display 1999 Average value measurement 	<ul style="list-style-type: none"> Bright and clear LED display Cost-effective Max. display 1999 	<ul style="list-style-type: none"> High accuracy indicator (± 0.03 % of FS) Max. display (-19999 ~ 19999) Retransmission output (4 - 20 mA d.c.) Communication function (RS232 or RS485) selection 	<ul style="list-style-type: none"> Non-power free scale high accuracy indicator (± 0.3 % of FS) Max. display (-1999 ~ 9999) Current input (4 - 20 mA d.c.)
Power voltage	100/240 V a.c.	5 V d.c., 12-24 V d.c.	100 - 240 V a.c.	Non-power
Display digits	± 19999			-1999 ~ 9999
Functions	Polarity display (BS3) Indication value hold by external contact	Decimal point and polarity display over range indication	Scale meter	
Input	4 - 20 mA d.c. / 1 - 5 V d.c. AC voltmeter / AC ammeter/ DC voltmeter/ DC ammeter	4 - 20 mA d.c. / 1 - 5 V d.c. DC voltmeter / DC ammeter	1 channel 1 - 5 V d.c., 4 - 20 mA d.c.	4-20 mA d.c.
Output	Indication only		4 - 20 mA d.c. Alarm output 2 contacts	Indication only
Page	95	96	97	93

Selection Table

■ Proximity Sensors

Type	Inductive Round Type Proximity Sensors	Inductive Square Type Proximity Sensors	Inductive Flat Type Proximity Sensors	Capacitive Type Proximity Sensors
Model	UP□R series	UP□S series	UP□F series	CUP series
Appearance				
Features	<ul style="list-style-type: none"> World's first exclusive IC for C-MOS Wide operating voltage (5- 35 V d.c. : DC 3-wire) Noise resistant reinforced circuit 2-wire type nonpolar applied 	<ul style="list-style-type: none"> World's first exclusive IC for C-MOS Wide operating voltage (5- 35 V d.c. : DC 3-wire) Noise resistant reinforced circuit 2-wire type nonpolar applied 	<ul style="list-style-type: none"> World's first exclusive IC for C-MOS Wide operating voltage Noise resistant reinforced circuit 2-wire type proximity nonpolar applied It can be installed directly on metal surfaces 	<ul style="list-style-type: none"> Noise resistant reinforced circuit Leakage current less than 2 mA Operating Voltage 12 - 240 V a.c./d.c. (2-wire)
Power voltage	100 - 240 V a.c., 12 - 24 V d.c.			10 - 240 V a.c./d.c., 12 - 24 V d.c.
Shield	Shield, Non shield		-	Non shield
Sensing distance	1.5, 2, 4, 5, 7, 8, 10, 14, 15, 25 mm	2, 4, 5, 8, 10, 12, 15, 20 mm	8 mm	8, 15 mm
Page	102	107	110	112

■ Photo Sensors

Type	General Purpose Photo Sensors	Amplifier Built-In Photo Sensors	Flat Photo Sensors	Ultra Small/ Ultra Flat Photo Sensors
Model	PB series	PLD	PY series	PCS / PCF series
Appearance				
Features	<ul style="list-style-type: none"> 25.4mm standard mounting hole Hanyoung Nux new ASIC chip used (operation stability, long-distance detection) Built-in VR for sensitivity adjustment Convenient operation mode selection by VR You can check the presence of overload with the output short circuit notification function Excellent noise immunity and reduced disturbance of light influence Strong protection circuit 	<ul style="list-style-type: none"> Power reverse connection and output short circuit protecting circuit built-in Diffuse-reflective type with 2 m of sensing distance 1 ms response time Sensitivity adjustment volume built-in IP64 (IEC 60529) degree of protection 	<ul style="list-style-type: none"> Light ON / Dark ON mode switching selection by control wire Power reverse connection and output short circuit protecting circuit built-in Convenient installation with the ultra slim size 1 ms response time Control output and stable output display 	<ul style="list-style-type: none"> Installation space minimized with the ultra small/ultra flat sizes High-performance one-chip photo ASIC The detection spot position can be checked with the visible light source Bright operation and stability indicators IP67 (IEC 60529) degree of protection
Power voltage	12 - 24 V d.c.			
Sensing mode	Through-beam, Diffuse-reflective, Retro-reflective (mirror), Retro-reflective (polarized mirror), Distance-settable	Diffuse-reflective	Through-beam	Through-beam , Diffuse-reflective
Sensing distance	7 m, 10 m, 15 m, 0.1 - 3 m, 1 m, 100 mm, 400 mm	2m	3 m	1 m, 5-30 mm
Operating mode	Light ON , Dark ON	Light ON	Light ON , Dark ON	
Response time	Max. 1 ms			
Page	115	123	117	116











Type	Light ON , Dark ON Voltage Output Photo Sensors	Round Photo Sensors	U-Shaped Fast Response Photo Sensors	Long Distance Detection Photo Sensors
Model	PN series	PR series	PU series	PEN series
Appearance				
Features	<ul style="list-style-type: none"> Power reverse connection and output short circuit protecting circuit built-in Motion display light attached Sensitivity adjustment volume attached Light ON/ Dark ON selectable by external wire 	<ul style="list-style-type: none"> Degree of protection IP66 (IEC 60529), round structure Output cutoff over current protecting circuit built-in Sensitivity adjustment volume attached Light ON /Dark ON selection 	<ul style="list-style-type: none"> Optic axis control not needed Solid die casting case Sensitivity adjustment volume attached Sensing distance 30/50 mm Operating mode selection by power polarity reverse connection 	<ul style="list-style-type: none"> Long distance detection IP64 (IEC 60529) degree of protection Stability indication
Power voltage	12 - 24 V d.c.			24 - 240 V a.c./d.c.
Sensing mode	Through-beam, Diffuse-reflective, Retro-reflective		Through-beam	Through-beam , Diffuse-reflective, Retro-reflective
Sensing distance	3 m, 0.1 - 1 m, 200 mm	10 m, 0.1 - 1 m, 0.1 - 2 m, 300 mm	30 mm, 50 mm	10 m, 0.1 - 5 m, 700 mm
Operating mode	Light ON , Dark ON			
Response time	Max. 3 ms	Max. 1.5 ms	Max. 1 ms	Max. 20 ms
Page	118	119	120	124



Photo Sensors

Type	Power /Amplifier Built-In Photo Sensors	Power Built-In Photo Sensors	Distance-settable Photo Sensors
Model	PTX series	PE series	PL-D2B
Appearance			
Features	<ul style="list-style-type: none"> Terminal block type connection for convenient wiring Wide power voltage range (24 - 240 V a.c. / d.c., 12 - 24 V d.c.) Timer function available NPN/PNP open collector simultaneous output with DC power IP66 (IEC 60529) waterproof structure 	<ul style="list-style-type: none"> Cost-effective Wide power voltage Relay output Operation status indication attached Lower impact of dust with the flat lens 	<ul style="list-style-type: none"> Distance setting reflective type by 2 split photo diodes Almost no influence of the amount of light change with the distance detection method by light angle Applicable in several fields with the long detection distance (2m) Power reverse connection and output short circuit protective circuit built-in IP65 (IEC 60529) protective circuit
Power voltage	24 - 240 V a.c./d.c.	24 V d.c., 100 - 240 V a.c./d.c.	12 - 24 V d.c.
Sensing mode	Through-beam , Diffuse-reflective, Retro-reflective		Distance-settable
Sensing distance	15 m, 7 m, 1 m	5 m, 0.1 - 3 m, 500 mm	0.2 - 2 m
Operating mode	Light ON , Dark ON		
Response time	Power built-in type: max. 20 ms Amplifier built-in type: max. 1 ms	Max. 25 ms	Max. 2 ms
Page	121	120	122

Fiber Optic Sensors

Type	Fiber Optic Sensors		Multi-Function Digital Fiber Optic Sensors
Model	PG series	PFB	PFD
Appearance			
Features	<ul style="list-style-type: none"> Applicable to any application with the AMP unit 4 type and several fiber unit types. Easy to install to a 35 mm wide DIN rail, so less installing space is needed. 	<ul style="list-style-type: none"> Sensitivity setting by auto-teaching Light volume indication by Bar LED External teaching input/external synchronous input Output delay time (40 ms fixed) Mutual interference prevention, power reverse connection protection, output short circuit protection Light ON/ Dark ON selection by slide switch 	<ul style="list-style-type: none"> Sensitivity setting by auto-teaching 7-Segment 4-digit LED display Mark detection/ counter / tachometer functions (multi-type) Output delay time setting (1 ~ 9999 ms)
Power voltage	12 - 24 V d.c.		
Sensing mode	Through-beam, Diffuse-reflective		
Sensing distance	By fiber optic cable		
Operating mode	Light ON , Dark ON		
Response time	Max. 1 ms		RM: max. 1 ms, RG: max. 0.7 ms
Page	125	127	126

Area sensors



Type	Area Sensors	Area Sensors Equipped With An Exclusive IC
Model	PAS series	PAN series
Appearance		
Features	<ul style="list-style-type: none"> Less installation space (thickness: 13.5 mm, width : 30 mm) Automatic sensitivity correction function built-in Mutual interference prevention function built-in Minimum sensing object (Ø30 mm) 	<ul style="list-style-type: none"> Several optical axis distances (20/40 mm) Mutual interference prevention function built-in Output short circuit protection circuit built-in Operating mode selection (all optical axes/1 optical axis light ON)
Power voltage	12 - 24 V d.c.	
Sensing mode	Through-beam	
Sensing distance	5 m	7 m
Operating mode	Output ON operation during light ON of all optical axes (output OFF operation during dark ON of 1 optical axis or more)	Emitter:M/S operation selection (mutual interference prevention setting) Receiver:A mode (light ON of all optical axes)/ O mode (light ON of 1 optical axis)
Response time	Max. 7 ms	Max. 7 ms, max. 15 ms
Page	128	129

Sensor Controllers



Type	Sensor Controllers
Model	HPA-12
Appearance	
Features	<ul style="list-style-type: none"> NPN/PNP dual usage input sensor controller Solid output contact (250 V 3 A, more than 100,000 times). Convenient installation with plug in method
Power voltage	220 V a.c.
Functions	Universal
Power consumption	Approx. 4 VA
External output power	12 V d.c., ± 10 %, max. 50 mA
Output	Relay 1c, 250 V a.c., 3A (resistive load)
Page	130

Selection Table

■ Sensor Controllers





Type	Sensor Controllers		
Model	HPAN-C7	HPAN-CT7	HPAN-C7W
Appearance			
Features	<ul style="list-style-type: none"> · Contact/contactless, 2 outputs built-in (HPAN-C7, HPAN-CT7) · For connecting 2 sensor · Corresponds to DIN rail 		
Power voltage	100 - 240 V a.c. 50/60 Hz ±10%		
Functions	Universal	High function (timer)	2 built-in sensors for connection
	2 inputs 1 output		2 inputs 2 outputs
Power consumption	Approx. 5 VA		
External output power	12 V d.c. (± 10 %), load current: max. 200 mA		
Output	OUT 1		OUT 1, OUT 2
	Contact	Relay 1 c, 250 V a.c., 3A (resistive load) ※ HPAN - C7W (1 c X 2 relay contact)	
Contactless	NPN open collector 30 V d.c., max. 200 mA		-
Page	130		





■ Rotary Encoders

Type	Shaft Type	Hollow Shaft Type	Blind Shaft Type
Model	HE30B, HE40B, HE50B	HE40H	HE40HB
Appearance			
Features	<ul style="list-style-type: none"> · Wide power voltage (5 - 12 / 12 - 24 V d.c.) · Several output specifications · Convenient installation structure 	<ul style="list-style-type: none"> · Wide power voltage (5-12/12-24 V d.c.) · Several output specifications · Convenient installation structure 	<ul style="list-style-type: none"> · Wide power voltage (5 - 12 / 12 - 24 V d.c.) · Several output specifications · Convenient installation structure
Power voltage	5 - 12 V d.c. ±5 %, 12 - 24 V d.c. ±5 %		
Output phase difference	Phase difference between A, B phases: T/4±T/8 (1 cycle of A phase=T)		
Response time	Max. 1 μs		
Number of pulses	1, 2, 5, 10, 12, 15, 20, 25, 30, 40, 45, 50, 60, 75, 100, 120, 125, 150, 192, 200, 240, 250, 256, 300, 360, 400, 500, 512, 600, 800, 1000, 1024		
Page	131	132	133





Type	Wheel Type
Model	PSC
Appearance	
Features	<ul style="list-style-type: none"> · The wheel type detection structure is suitable for length and speed measurement · Several measuring units (6 types) · Cost-effective · Convenient installation structure
Power voltage	5 - 12 V d.c. ±5 %, 12 - 24 V d.c. ±5 %
Output phase difference	Phase difference between A, B phases: T/4±T/8 (1 cycle of A phase=T)
Response time	Max. 1 μs
Number of pulses	According to the minimum measured length
Page	134

■ Thyristor Power Regulators

Type	Slim Type Single-Phase Thyristor Power Regulators		Single-Phase Thyristor Power Regulators	Small 3-Phase Thyristor Power Regulators
Model	TPR-2M	TPR-2SL	TPR-2N	TPR-3M
Appearance				
Features	<ul style="list-style-type: none"> Several protection functions (heater break, overcurrent, heat sink overheating, SCR short circuit, etc) Improved safety by of circuit power supply and load power supply separation (free voltage) SOFT START(60 sec), SOFT UP/DOWN (15 sec) Status indication with 4 LEDs 	<ul style="list-style-type: none"> Alarm output divided into caution and warning Several Control types available depending on load Several protection functions (partial heater break, overcurrent, heat sink overheating, SCR short circuit, etc) Improved safety by of circuit power supply and load power supply separation (free voltage circuit) 	<ul style="list-style-type: none"> Maximum output voltage setting by gradient setting Several input signals Phase control/cycle control internal selection 	<ul style="list-style-type: none"> 110 mm (width) small 3-phase slim type thyristor power regulators Improved safety with the separate power supply 4 LEDs to check operation status and alarm Several alarm functions. "Caution" and "warning" alarm separation.
Power voltage	100 - 240 V a.c., 100 - 440 V a.c.	100 - 240 V a.c., 380 - 440 V a.c.	100 - 240 V a.c., 380 V a.c.	100 - 240 V a.c.
Rated current	25 A, 35 A	25A, 40A, 55A, 70A, 90A, 110A, 130A, 160A, 200A	25 A, 35 A, 50 A, 70 A	25A, 45A
Control type	Phase control (standard), variable cycle control (optional)	Phase control, cycle control, ON/OFF control (dip switch selection)	Phase control, fixed cycle control, variable cycle control, ON/OFF control	Phase control (fixed cycle control, variable cycle control option)
Page	137	136	135	142





Type	Slim Type 3-Phase Thyristor Power Regulators	3-Channel Each Phase Control Thyristor Power Regulators	3-Phase Thyristor Power Regulators	
Model	TPR-3SL	TPR-3SL-EP	TPR-3N	TPR-3
Appearance				
Features	<ul style="list-style-type: none"> The slimmest type among 3-phase thyristor power regulators under the same rating (110 mm) The heat sink excellent design and several protection circuits provide high durability. Improved safety with the separation of circuit power supply and load power supply Several alarm functions (heater break, load imbalance, heat sink overheating, overcurrent, etc.) 	<ul style="list-style-type: none"> 3 individual phase controls available in one product Setting and monitoring with RS485 communication Load input power single-phase, and 3-phase available. Free voltage available (100-440V a.c) Several protection functions 	<ul style="list-style-type: none"> Status indication with 9 LEDs Several protection functions Soft start / Soft up / Soft down Fast fuse built-in 	<ul style="list-style-type: none"> Status indication with 9 LEDs Several alarm functions Soft start & Soft down Fast fuse built-in
Power voltage	100 - 240 V a.c., 380 - 440 V a.c.	100 - 240 V a.c., 100 - 440 V a.c.	220, 380, 440 V a.c.	
Rated current	40A, 55A, 70A, 90A, 130A, 160A		70A, 100A	70A, 100A, 150A, 200A, 250A, 320A, 500A, 600A
Control type	Phase control, fixed cycle control, variable cycle control, ON/OFF control		Phase control, ON/OFF control	Phase control, ON/OFF control, cycle control
Page	140	141	139	138

■ Solid State Relays



Type	Single-Phase Solid State Relays		3-Phase Solid State Relays	
Model	SSR-2	HSR-2	SSR-3	HSR-3
Appearance				
Features	<ul style="list-style-type: none"> Terminal protection cover for safety Two types of load voltage (low voltage 90-264 V a.c. / high voltage 90 - 480 V a.c.) Operation check by operation indicator (red LED) Zero cross switching/ random switching 	<ul style="list-style-type: none"> Load voltage 90 - 264 V a.c. / 90 - 480 V a.c. High insulation between input and output High reliability as non-contact C-R Snubber, Zero cross switching 	<ul style="list-style-type: none"> Terminal protection cover for safety Two types of load voltage (low voltage 90-264 V a.c. / high voltage 90 - 480 V a.c.) Operation check by operation indicator (red LED) Zero cross switching / random switching 	<ul style="list-style-type: none"> Load voltage 90 - 264 V a.c. / 90 - 480 V a.c. High insulation between input and output High reliability as non-contact C-R Snubber, Zero cross switching
Input voltage	70 - 264 V a.c., 4.6 - 32 V d.c.	4 - 32 V d.c., 90 - 264 V d.c.	70 - 264 V a.c., 4.6 - 32 V d.c.	4 - 32 V d.c., 90 - 264 V d.c.
Rated load current	10 A, 20 A, 30 A, 40 A	10 A, 20 A, 30 A, 40 A, 50 A, 70 A	10 A, 20 A, 30 A, 40 A	10 A, 20 A, 30 A, 40 A, 50 A, 70 A
Load voltage	90 - 264 V a.c., 90 - 480 V a.c.			
Page	143	145	147	149

Selection Table





Solid State Relays

Type	Slim Type Single-Phase Solid State Relays	2-Wire Cutoff Solid State Relays	Slim Type 3-Phase Solid State Relays	Single-Phase Solid State Relays For PCB Substrate
Model	HSR-SL	HSR-2SLD / SE	HSR-3SL	HSR-PD
Appearance				
Features	<ul style="list-style-type: none"> · 22.4 mm Slim Type · Load voltage 90 - 264 V a.c. / 90 - 480 V a.c. · High insulation between input and output · C-R Snubber, Zero cross switching · Improved safety and working convenience with the heat sink one-body type. 	<ul style="list-style-type: none"> · Status indication with several LED displays · Control each phase simultaneously with the 2-wire disconnection function · When the temperature of heat sink is 60 °C / 80 °C, the alarm output works and operation stops · Improved safety and working convenience with the heat sink one-body type (din rail is available). · It has the mandatory functions required from FPD industry 	<ul style="list-style-type: none"> · Din rail installation type · Improved safety and working convenience with the heat sink one-body type · Can be installed in small spaces with the small design · It is the slimmest type among the 3-phase solid state relays under the same rating (79 mm) 	<ul style="list-style-type: none"> · Load voltage 90 - 240 V a.c · High insulation between input and output · Compact, lightweight, with large capacity · High reliability as non-contact · Zero cross switching
Operating voltage range	4 - 32 V d.c.			
Rated load current	15A, 25A, 40A	25A, 40A	15A, 25A, 40A	3A, 5A
Load voltage	90 - 264 V a.c., 90 - 480 V a.c.			90 - 240 V a.c.
Page	151	152	153	154



Power Supplies

Type	DIN Rail Type Power Supplies	Enclosed type Power Supplies
Model	DPS	TPS
Appearance		
Features	<ul style="list-style-type: none"> · 35 mm width DIN Rail installation method · Low output voltage fluctuation · High efficiency and low heat generation · Equipped with DC OK signal relay output · Overcurrent, overvoltage, overheating protection functions · Wide product range from 15W to 240W · Output ON indication (LED) · Input voltage 100 - 240 V free voltage or 110/220 V automatic selection 	<ul style="list-style-type: none"> · Input inrush current limit · Output voltage adjustable volume · CE certification · Overcurrent/overvoltage/short circuit protection/overheating protection
Power output	15 W, 30 W, 50 W, 75 W, 100 W, 120 W, 180 W, 216W, 240 W	15 W, 30 W, 50 W, 55 W, 75 W, 100 W, 150 W, 220 W, 230 W, 350 W, 450 W
Input voltage	100 - 240 V a.c. , 100 - 120 V a.c. / 200 - 240 V a.c.	
Output voltage	5 V, 12 V, 15 V, 24 V, 48 V	5 V, 12 V, 15 V, 24 V, 48 V, 24/05 V, 24/12 V, 24/24 V
Voltage fluctuation range	± 5 ~ 10 % (according to internal VR)	
Protection circuit	Overcurrent, overvoltage, overheating, output short-circuit protection	
Dielectric strength	2700 V a.c. for 1 min (Input - Output)	
Page	155	156



Control Switches

Type	Ø22, Ø25, Ø30 LED Switches		Ø25, Ø30 LED Switches	Ø16 Switches
Model	MR	AR	CR	SR
Appearance				
Features	<ul style="list-style-type: none"> 3 aluminum guard and 2 plastic guard types provide wide configuration possibilities High brightness and durability with the LED light Double break snap action open / close contacts with self-diagnosis function for high contact reliability 	<ul style="list-style-type: none"> Elegant European design Easy to attach and detach actuators and contacts Ø22, 25 dual usage 	<ul style="list-style-type: none"> Ø25, Ø30 series 1a1b one-body type Long life with the bright LED light source Convenient product configuration with the modular actuators and contacts High contact reliability with the slow-make contact point and self-diagnosis function Product weight reduced 	<ul style="list-style-type: none"> Light operation feeling with high-performance contacts Upper and lower side separated High-quality small-size control unit applicable to a wide range of applications from automation equipment to FA Incandescent lamp / LED selectable
Type	Push buttons, illuminated push buttons, pilot lamps, selectors, key selectors, illuminated selectors, emergency switches, illuminated emergency switches, buzzers	Push buttons, illuminated push buttons, pilot lamps, selectors, illuminated selectors, key selectors, emergency switches	Push buttons, illuminated push buttons, pilot lamps, selectors, key selectors, emergency switches	Push buttons, illuminated push buttons, pilot lamps, selectors, key selectors, emergency switches
Power voltage	100 - 240 V a.c., 380 V a.c., 12 - 24 V a.c. / d.c.	110 V a.c., 220 V a.c.	100 - 240 V a.c., 380 V a.c., 12 - 24 V a.c. / d.c.	6.3 V a.c./d.c., 12 V a.c./d.c., 24 V a.c./d.c.
Dielectric strength	2000 V a.c. for 1 min	2000 V a.c. for 1 min (among pole terminals)	1500 V a.c. 60 Hz for 1 min	2000 V a.c. each 50/60 Hz for 1 min
Page	158	160	161	162

Combination Display Lights



Type	LED Square Indicators	LED Combination Display Lights
Model	CR40	CD
Appearance		
Features	<ul style="list-style-type: none"> Display surface size 40 X 32 mm Bright LED light source Convenient individual mounting, gathered / assembled mounting Gathered / assembled mounting by the + appearance connector (die casting) 	<ul style="list-style-type: none"> Display surface size 30(W) x 30(H) mm, 30 X 40 mm 2Type High brightness square LED units 6 indicating colors Simple assembling. Able to change the colors on the spot Max. 200 compositions (10 rows, 20 columns)
Power voltage	100 - 240 V a.c., 380 V a.c., 12 - 24 V d.c.	110 / 220 V a.c., 24 V d.c., 110 / 125 V d.c.
LED display color	Red, green, yellow, blue, white	Red, green, yellow, white, orange, blue
Dielectric strength	1500 V a.c. for 1 min	2000 V a.c. for 1 min
Page	162	163

Power Switches

Type	Power Switches	
Model	HY-500	BE
Appearance		
Features	<ul style="list-style-type: none"> Directly turn ON/OFF the power of compact electric motor Exposed type/flush type, plastic/cold rolled steel case Push buttons for turning ON/OFF electric motors (forward, reverse operations) Lamp power ON/OFF switch mounting type Electrical appliances safety certification 	<ul style="list-style-type: none"> Directly turn ON/OFF the power of compact electric motor Exposed type/flush type, plastic/cold rolled steel case Push buttons for turning ON/OFF electric motors (forward, reverse operations) Waterproof non-flammable ABS Plastic Case
Rated capacity	250 V a.c. 15A	440 V a.c. 15 ~ 30 A
Display legends	ON, OFF, FOR, STOP, REV	
Case material	Cold rolled steel case, plastic	Cold rolled steel case, non-flammable ABS
Page	163	164

Selection Table



Cam switches

Type	Cam switches	
Model	HY-SQ5 / 255 / 305 / MRK	SQ4
Appearance		
Features	<ul style="list-style-type: none"> ▷ HY-SQ5 / 305/255 series <ul style="list-style-type: none"> · Several surfaces (square, Ø25 round, Ø30 round) · Switch-board switch A/S, V/S, C/S standard manufacturing product · Machine tools and electrical installation custom circuit configurations for every industry ▷ HY-MRK <ul style="list-style-type: none"> · Handle lock function by key lock · Rated current 20A, high capacity cam switches/ custom circuit configuration 	<ul style="list-style-type: none"> · Small Cam switches (48(W) X 48(H) mm) · 2 operation handles (H type, R type) · Ammeter switch (AS), voltmeter switch (VS) · Small cam switches with several circuit configurations
Rated insulation voltage	600 V	690 V a.c.
Rated current	10 A	16A-24 V a.c., 8A-48 V a.c., 5A-110 V a.c., 3A-220 V a.c., 1.8A-380 V a.c.
Dielectric strength	2500 V a.c. for 1 min	
Page	165	166

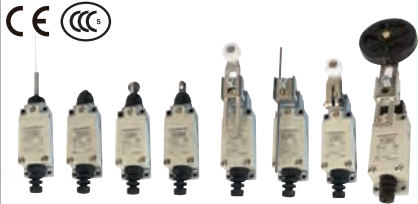

Main Switches

Type	Main Switches
Model	MAS
Appearance	
Features	<ul style="list-style-type: none"> · Designed as rapid switching structure for excellent contact reliability · Lock ring applied in the OFF state · Handle and contact parts with detachable structure (MAS-025) · 2 color types of handle and handle guard (red/yellow and black/white) · Ø22, Ø30 (MAS-025), 4 holes fixed panel mounting · Clear indication of ON/OFF contact status (turning OFF the operation handle will block all contacts)
Rated insulation voltage	690 V a.c.
Rated current	25A, 63A, 125A
Materials	Non-flammable
Page	164

Limit Switches

Type	Aluminum Die Casting	Zinc Die Casting	Plastic Case
Model	HY-M900	HY-L800	HY-LS800
Appearance			
Features	<ul style="list-style-type: none"> · Solid die casting case and 2 circuits double micro switch built-in · High mechanical intensity with the heat resistant, oil proof and dust protection structure · IP67 (IEC 60529) degree of protection (when using the company HYC-M1 connector in wire opening) · Check the operation state on the outside with the operation indicator 	<ul style="list-style-type: none"> · Less installation space with the compact size · Zinc die casting body and plastic cover structure · 4 actuator types provide wide selection possibilities · Applicable to machine tools, transportation machines, assembling lines and several industrial machines 	<ul style="list-style-type: none"> · Compact size and lightweight with the plastic case · The plastic case is safe against electric leakage · 6 actuator types provide wide selection possibilities
Open/close frequency	Mechanical: 120 times/min, electrical: 20 times/min		
Insulation resistance	Min. 100 MΩ (500 V d.c.)		
Dielectric strength	Among terminals: 1000 V a.c. 50/60 Hz for 1 min, Among unfilled metal parts: 1500 V a.c. 50/60 Hz for 1 min	Among terminals: 1500 V a.c. 50/60 Hz for 1 min, Among unfilled metal parts: 2000 V a.c. 50/60 Hz for 1 min	1000 V a.c. 50/60 Hz for 1 min, 2000 V a.c. 50/60 Hz for 1 min
Page	167	167	168

Micro Switches

Type	Micro Switches	
Model	HY-700	ZCN-500
Appearance		
Features	<ul style="list-style-type: none"> · Certain operation and long life with the snap action tool · Excellent repetitive accuracy and 10A open/close capacity · Standard type, installation hole gap: 25.4mm, fixed with M4 bolt · 9 actuator types provide wide selection possibilities · Terminal protective cover (optional) 	<ul style="list-style-type: none"> · Certain operation and long life with the beryllium copper and running spring to the strong chemically resistant resin case. · Compact, lightweight, with strong mechanical durability · 9 actuator types provide wide selection possibilities
Open/close frequency	Mechanical: 120 times/min, electrical: 20 times/min	
Insulation resistance	Min. 100 MΩ (500 V d.c.)	
Rated current	10A 250 V a.c.	
Page	169	168

Selection Table



■ Foot Switches

Type	Foot Switches
Model	HY-100
Appearance	
Features	<ul style="list-style-type: none"> High mechanical safety with the aluminum case Micro switch with excellent electrical reliability built-in Protective cover from falling materials and safety latch lever attached. (HY-104) Cable locker applied (HY-103, 104) Cost-effective plastic case (HY-101)
Rated current	10 A 250 V a.c.
Foot switch materials	Plastic, aluminum
Contact structure	C Contact
Page	170



■ Mono Lever Switches



Type	Mono Lever Switches
Model	LEL / LES
Appearance	
Features	<ul style="list-style-type: none"> 4-direction switches that can operate 4 directions in a single lever The lever tilting direction minimizes malfunctions during use and it is suitable for products that are frequently switched in direction. There are auto returning, manual returning and mixed types depending on lever operation type. The circuit configuration of the contact part is flexible and the installation cutout hole is Ø30.
Rated insulation voltage	600 V
Rated electric current	3 A 250 V a.c.
Dielectric strength	2500 V a.c. for 1 min
Page	170

■ Pendant Switches

Type	Pendant Switches	
Model	HY-1020	HY-P series
Appearance		
Features	<ul style="list-style-type: none"> Used in hoists, cranes, truck lifts, electric lifts, etc. Also available with built-in emergency switch. Several contact unit compositions (2-stage contact unit for motor speed control, momentary operation, alternate operation, seesaw contact unit) Case made of high impact ABS resin, providing excellent mechanical strength, shock durability, electric shock protection and electrical properties 	<ul style="list-style-type: none"> Easy wiring and operation with the wire holder bending structure (15°) Solidity improved with the thicker high impact ABS resin, and anti-slip structure The wide internal wiring space makes wiring easier and more convenient Several new features on-demand (LED, volume, toggle switch).
Degree of protection	IP66 (IEC 60529) (emergency switch type excluded)	IP65 (IEC 60529) (emergency switch type included)
Materials	Case: ABS, screws: cover bolt (stainless steel screws), button coating: special rubber (black), cable bracket: special rubber (black)	Case: high impact ABS, Contacts: AgSnO2
Insulation resistance	Min. 100 MΩ (500 V d.c.)	Min. 100 MΩ (500 V d.c.)
Page	171	172

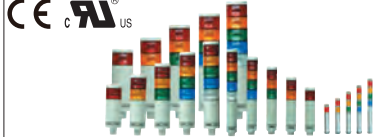

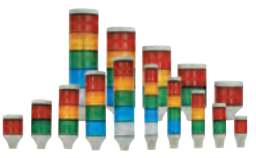
■ Sign Towers



Type	Ø25 Modular LED Sign Towers	Ø60 Modular LED Sign Towers	LED Sign Towers
Model	STE025	STE060	STL
Appearance			
Features	<ul style="list-style-type: none"> Ø25 column type, suitable installation structure for small machines and narrow spaces Long life with high brightness LED light source 1~3 stacks and 3 color types Easy installation with pipe direct installation structure Convenient configuration (number of stacks and colors) with the modular type Continuous light only 	<ul style="list-style-type: none"> Long life with the high brightness LED light source Simple structure from 1 to 5 stacks Several mounting supporters Convenient configuration (number of stacks and colors) with the modular type 	<ul style="list-style-type: none"> ▷ Ø25, Ø40, Ø60, Ø80 Long life with the high brightness LED light source 1~5 stacks and 5 color types Convenient installation with the aluminium pipe direct installation structure Cost-effective, continuous light models with IP54 (IEC 60529) degree of protection Several sizes (Ø25, Ø40, Ø60, Ø80) Continuous light/flushing/buzzer models (selection by external signal)
Diameter	Ø 25	Ø 60	Ø 25 Ø 40, Ø 60, Ø 80
Supporter	L type bracket (sold separately)	Plastic round supporter, L type bracket, elbow type supporter (optional)	
Rated voltage	24 V d.c.	24 V d.c., 100 - 240 V a.c. 50/60 Hz	24 V d.c., 24 V a.c. / d.c., 100 - 240 V a.c. 50/60 Hz
Number of stacks & colors	1~3 stacks (red, green, yellow)	1~5 stacks (red, green, yellow, blue, white)	
Page	177	176	175

Type	Ø40, Ø60, Ø80 LED Sign Towers	Ø55 Sign Towers
Model	STS	HY-TN
Appearance		
Features	<ul style="list-style-type: none"> Several sizes (Ø40, Ø60, Ø80) Long life with the high brightness LED light source 1~5 stacks and 5 color types 3 installation types Continuous light only 	<ul style="list-style-type: none"> Ø55 round type 1~5 stacks and 5 color types Continuous light, continuous light/flushing/buzzer (selection by external signal)
Diameter	Ø40, Ø60, Ø80	Ø55
Supporter	Plastic round supporter, L type bracket, elbow type supporter (optional)	Plastic round supporter, L type bracket, elbow type supporter (optional), Plastic supporter with pipe connection
Rated voltage	24 V a.c. / d.c., 12 V a.c. / d.c. (order-made)	24 V d.c., 220 V a.c.
Number of stacks and colors	1~5 stacks (red, green, yellow, blue, white)	
Page	174	178



Selection Table

■ Indicating Lights

Type	LED Wall Mounted Lights	
Model	WME	WMS
Appearance		
Features	<ul style="list-style-type: none"> 3-color slim type, suitable for wall mounting Long life with the high brightness LED light source 2 body type: beige or chrome plated Continuous light, flashing light, 2-melody buzzer built-in Degree of protection IP54 (IEC 60529) 	<ul style="list-style-type: none"> 1~5 stacks, suitable for wall mounting Long life with the high brightness LED light source 2 types of buzzer melodies (single melody/ beeping) Continuous light, flashing light Degree of protection IP54 (IEC 60529)
Diameter	-	
Rated voltage	24 V a.c./d.c., 12 V a.c./d.c. (order-made)	
Functions	Continuous light · flashing · buzzers	
Number of stacks and colors	3 tiers Red, green, yellow	1~5 tiers Red, green, yellow, blue, white
Page	179	180



Type	Signal Lights (Xenon)	Ø84 LED Signal Lights	Ø70 LED Signal Lights
Model	RLA-WX / WXB	LT	SLB
Appearance			
Features	<ul style="list-style-type: none"> Ø118 Rotating continuous light only, rotating continuous light and buzzers built-in Xenon tube strobe light Excellent instant light emitting and high brightness Less current consumption compares to the rotating light and 4 times longer life expectancy compared to the regular lamp Simple attaching/detaching due to the permanent magnet attachment type (for cars) Degree of protection IP54 (IEC 60529) 	<ul style="list-style-type: none"> Rotational flickering function by the sequential flashing Long life with the high brightness LED light source Ø84 round cap, direct or supporter mounting Acrylic cap for excellent visible light transmittance Solid and smart design Degree of protection IP54 (IEC 60529) 	<ul style="list-style-type: none"> Continuous light, flashing light, buzzer (selection by external signal) Long life with the high brightness LED light source Select Ø70 round type cap, rectangular type cap, direct installation, supporter mounting installation Cost-effective, simple installation structure Solid polycarbonate protective cap Degree of protection IP54 (IEC 60529)
Diameter	Ø118	Ø84	Ø70
Rated voltage	110 V a.c., 220 V a.c., 12 V d.c., 24 V d.c.	12 - 24 V a.c., 110/220 V a.c., 12 - 48 V d.c.,	12 V a.c. / d.c., 24 V a.c. / d.c., 110 - 240 V a.c.
Functions	Rotating continuous light · buzzers	Rotating continuous light, flashing, buzzer built-in	Continuous light, flashing, buzzers (selection by external input signal)
Colors	Red, blue, white	Red, yellow, green, blue	Red, yellow, green
Page	182	183	183

■ Warning Lights



Type	Ø60 / Ø84 / Ø100 / Ø150 Revolving Warning Lights	Ø118 Revolving Warning Lights
Model	T series	RLA-KB / KBB
Appearance		
Features	<ul style="list-style-type: none"> Ø60 / Ø84 / Ø100 / Ø150 rotating continuous light, rotating continuous light and buzzers Incandescent lamp indicator (socket type) Several supporter mounting type Cost-effective, simple installation structure Solid polycarbonate protective cap Rotational structure with the excellent abrasion resistive acetal gear Degree of protection IP54 (IEC 60529) 	<ul style="list-style-type: none"> Ø118 rotating continuous light / rotating continuous light and buzzer built-in Incandescent lamp (BA 15S) Used the special power transmitting plant, less noise and long life expectancy Large size rotational reflector is built-in, excellent light reflection Excellent attaching / detaching due to the permanent magnet attachment type (refer to the suffix code) Degree of protection IP54 (IEC 60529)
Diameter	Ø60 / Ø84 / Ø100 / Ø150	Ø118
Rated voltage	110 V a.c., 220 V a.c., 12 V d.c., 24 V d.c.	110 / 220 V a.c., 12 V d.c., 24 V d.c.
Functions	Rotating continuous light · buzzers	
Colors	Red, yellow, green, blue	Red, green, yellow
Page	181	182

Selection Table

Buzzers

Type	Power Buzzers	4-Tone Buzzers	3-Tone Electronic Buzzers
Model	HY-256 / 306 / 606 / 606N	HY-606MD / MA	HY-226M / 256M
Appearance			
Features	<ul style="list-style-type: none"> Compact size, lightweight, high capacity buzzer melody Excellent alarm function Suitable for panel installation Low Power consumption 	<ul style="list-style-type: none"> 4 tones of melody selectable Compact, light weight, high capacity tones Low Power consumption and long life expectancy Simple installation structure with the panel installation type 	<ul style="list-style-type: none"> Compact, lightweight, with 3 melodies Front LED illuminates during buzzer operation Simple installation structure with the panel installation type Low Power consumption
Rated voltage	110 V a.c., 220 V a.c., 12 V d.c., 24 V d.c.	12 / 24 V d.c., 110 / 220 V a.c.	100 - 240 V a.c., 12 - 24 V d.c.
Power consumption	4 VA, 8 VA, 30 mA	2.5 W	0.6 W, 13.5 W
Volume (1 m distance)	85 dB	Max. 98 dB	80 dB
Page	184	184	184

Terminal Blocks

Type	Assembly Terminal Blocks		Fixing Type Terminal Blocks
Model	HYBT-15A2	HYTM	HYT
Appearance			
Features	<ul style="list-style-type: none"> DIN rail installation structure Possible to assemble the terminal block with different capacity to the same fixing plate Excellent attaching / detaching of terminal at the temporal position 	<ul style="list-style-type: none"> New design (simple and robust image) Contact protective structure for the terminal block live parts O-type and Y-type crimp terminal use more convenient with the screw self-up structure Din Rail one-touch assemblable and detachable structure (using slotted screwdriver during removal) 	<ul style="list-style-type: none"> Several polarities for each current capacity, easy selection Body made of phenolic resin (60 - 500 A) and ABS flame retardant resin (10 - 30 A) Because the bolt and plate underwent heat treatment and rust-proof treatment, it has excellent electrical and mechanical characteristics Standard product of rated current Simple installation
Rated insulation voltage	600 V		
Rated current	15A	15A, 25A, 35A, 60A, 100A	10A, 20A, 30A, 60A, 100A, 150A, 200A, 300A, 400A, 500A
Insulation resistance	Min. 100 MΩ (between each charging part and between each charging part and mounting metal plate)		
Page	185	185	188

Fuse Holders

Type	Fuse Holders
Model	HY-F15 / HY-F30
Appearance	
Features	<ul style="list-style-type: none"> HY-F15 series <ul style="list-style-type: none"> LED continuous light indication during fuse disconnection / safety cover installation structure DIN rail and bolt fixing structure / Easy installation by 1P, 2P, 3P individual products HY-F30 series <ul style="list-style-type: none"> Body materials are made of NYLON66 with glass fiber and have excellent electrical insulation, strong against impact and heat The fuse comes out when replacing it, which provides excellent safety
Rated current	24 V d.c. 10 A, 250 V a.c. 15 A, 250 V a.c. 30 A
Remarks	110-220 V a.c., 12-24 V d.c., 110-600 V a.c.
Page	189

Cable Connectors

Type	Cable Connectors
Model	HYC-M1 / HYC-M2
Appearance	
Features	<ul style="list-style-type: none"> Applied as waterproof and spinning-proof when extending the cable from many machine tools PF 1/2 cover fixing type nut Nut tightening structure by the seal rubber and stuffing washer
Materials	PC (resin)
Remarks	Ø8, Ø11
Page	190

Control Boxes

Type	Control Boxes
Model	Roller Steel Control Boxes HY-25 / HY-30
Appearance	
Features	<ul style="list-style-type: none"> Roller iron and ivory color enamel painted Several operating switches attached (Ø20 and Ø30) Several specifications (1 ~ 6 holes)
Materials	Roller steel
Remarks	Ø25, Ø30
Page	190

Temperature Controllers

TD510 Programmable Temperature Controllers

Specifications

Model		TD510		
Appearance				
W×H×D (mm)		145.0×145.0×33.5		
Power voltage		100 - 240 V a.c. 50/60 Hz (Voltage fluctuation rate: ±10 % of power voltage) max. 30 V A		
Dielectric strength		Between 1st and 2nd terminals: Min. 1500 V a.c for 1 min, between 1st and FG terminals: Min. 1500 V a.c for 1 min Between 2nd and FG terminals: Min. 1500 V a.c for 1 min		
Input type		<ul style="list-style-type: none"> • 2 types of RTD (Pt-100, KPt-100) ±0.1 % of FS ±1 Digit • 11 types of thermocouple (K, J, E, T, R, B, S, L, N, U, Wire 5 - 26) ±0.15 % of FS ±1 Digit • 4 types of DC voltage (-10 - 20 mV, 0 - 100 mV, 1 - 5 V, 0 - 30 V) ±0.1 % of FS ±1 Digit 		
Sampling cycle		250 ms		
Contact output (DO)	Up to 32 relay contacts	A contact	Max. 30 V d.c. 3 A, 250 V a.c. 3 A	
		B contact	NO: max. 30 V d.c. 5 A, 250 V a.c. 5 A	
Control output	SSR output	ON: 18 V d.c. pulse voltage (load resistance min. 800 Ω)		
	SCR output	4 - 20 mA d.c. (load resistance max. 600 Ω)		
Retransmission output	Current output	4 - 20 mA d.c.		
	Load resistance	Load resistance max. 600 Ω		
	Output type	Present value (PV), Set value (SV), output volume (MV), Random selection		
	Refresh interval	250 ms		
Functions	Input type	Input calibration (sensor bias)	Temperature 2 contacts: EUS (0 ~ 100 %)	
		Scaling	DC voltage (VDC): Input scaling according to conversion range	
		Input filter (LPF)	0 ~ 120 sec	
	Control mode	Operation type	Constant-value / Program control	
	Control output	Temperature control output	SSR or SCR (4 - 20 mA d.c.) output selection	
		Control operation	Pattern	100 patterns (1 pattern / 100 segments)
	Segment		2000 segments	
	PID group		4 groups	
	Auto-tuning		Auto-tuning according to target set value	
	Proportional band		0.00 ~ 100.00% (ON / OFF control for 0.00%)	
	Integral time		0 ~ 3000 seconds (OFF state if 0 second is set)	
	Derivative time			
	ON/OFF control		Set proportional band (PB) to 0	
	Direct/reverse action	Depending on the direct/reverse action selection of the control output		
	Hysteresis	EUS (0 ~ 100 %)		
	Retransmission output	Temperature (Ch.1 and 2)	4 - 20 mA d.c. Present value (PV), Set value (SV), output volume (MV)	
		Scaling	Auto scaling for defined upper/lower, limit range (4 - 20 mA d.c.)	
	Alarm setting	Setting alarm	System alarm: 8 contacts. Assign 4 of 8 pattern alarms to a pattern	
		Alarm type	High/Low absolute, High/Low deviation, Within/Out of range (alarm direction, hold)	
Absolute alarm setting range		EU (0 ~ 100 %)		
Deviation alarm setting range		EUS (-100 ~ 100 %)		
Hysteresis		EUS (0 ~ 100 %)		
Display		TFT color LCD (115.2 × 86.4 mm)		
Resolution		640 × 480 pixel		
Back light		LED Back light		
Back light life		Approx. 40,000 h		
Touch type		Resistive type (4 Wires)		
Language		Korean/English/Chinese (simplified)		
Saving functions	Internal memory	Non-volatile memory: 80 MB		
	External memory	SD card (4 GB)		
	Saving interval	1 ~ 360 sec		
Memory information		Program information, set value save, recovery, temperature set / process / output value		
Ambient temperature & humidity		0 ~ 50 °C, 20 ~ 90 % RH (without condensation)		
Weight		Approx. 1.32 kg		

Temperature Controllers

Suffix code

Model	Code	Content
TD	<input type="checkbox"/> 1 <input type="checkbox"/> - <input type="checkbox"/> <input type="checkbox"/> <input type="checkbox"/>	Programmable Temperature Controller
Display part	5	5.7" TFT-LCD
Channels	1	1 channel
	2	2 channels
Input/output	1	8 input contacts · 6 output contacts (1 module)
	2	8 input contacts · 14 output contacts (2 modules)
	3	16 input contacts · 16 output contacts (3 modules)
Language	S	Korean, English and Chinese (simplified)
	T	Korean, English and Chinese (traditional)
Communication		RS485
	E	RS485, Ethernet

Components

Product	Model	Content
Display part	TD51□-1N□	Display part (5.7" TFT LCD)
Control module	TD510-MAIN	Temperature 2-channel control module
	TD511-MAIN	Temperature 1-channel control module
Power module	TM-PWR	Power module
Input module	TM-DI	Module with 16 input contacts
Output module	TM-DO	Module with 8 output contacts
Input/output module	TM-DIO	Module with 8 input and 6 output contacts

※ This product consists of display part / power module / control module / input module / output module (digital input (DI) with up to 32 contacts, digital output (DO) with up to 32 contacts).

TD500 Programmable Temperature Controllers

Specifications

Model	TD500	
Appearance		
W×H×D (mm)	183.0×144.0×102.7	
Power voltage	100 - 240 V a.c. 50/60 Hz 1 max. 6 W. (voltage fluctuation rate: ±10 % of power voltage)	
Screen	5.7 "STN-LCD and touch panel interface	
Program	Up to 100 patterns, individual pattern operation possible for each channel / Up to 2,400 segments (up to 100 segments per pattern)	
Input (2 channels)	Pt100 (IEC751)	-200.0 ~ 640.0 °C, ± 0.1 % of FS
	TC_K	-200.0 ~ 1,370.0 °C, ± 0.1 % of FS
	TC_J	-200.0 ~ 1,200.0 °C, ± 0.1 % of FS
	TC_E	-200.0 ~ 1000.0 °C, ± 0.1 % of FS
	TC_T	-200.0 ~ 400.0 °C, ± 0.1 % of FS
	TC_R	0 ~ 1,700.0 °C, ± 0.1 % of FS
	TC_S	0 ~ 1,700.0 °C, ± 0.1 % of FS
	mV	0 - 100 mV or -10 - 20 mV (-999.9 - 9999.9), ± 0.1 % of FS
	VDC	0 - 10 V (the signal range can be set, -999.9 - 9999.9), ± 0.1 % of FS
4 - 20 mA	250 Ω using the external resistor, V d.c. 1 ~ 5 V using after setting	
Sampling cycle	500 ms	
Output	Control output	2 contacts for each channel (heating/cooling)
	Voltage pulse output (SSR)	24 V d.c. Pulse (load resistance min. 600 Ω), minimum pulse width: 10 ms
	Current output (SCR)	4 - 20 mA d.c. (load resistance max. 600 Ω)
	Relay output	<ul style="list-style-type: none"> External relay using built-in relay or Tr output (max. 24 V, 100 mA) Built-in relay specifications: NO → 250 V a.c. 5 A / 30 V d.c. 5 A, NC → 250 V a.c. 2 A / 30 V d.c. 1 A
Communication	<ul style="list-style-type: none"> RS485 communication distance: approx. within 1.2 km Max. number of connections: 32 Communication speed: max. 115,200 bps RS 232, RS422/485	
Ambient temperature & humidity	0 ~ 50 °C, 20 ~ 90 % RH (without condensation.)	
Weight	Approx. 2.35 kg	

Suffix code

Model	Code	Content
TD500	<input type="checkbox"/> <input type="checkbox"/>	2-Channel Programmable Temperature Controller
Types	N	None (only when need the input/output board)
	1	Communication (RS485/422 communication, USB)
	2	Communication (RS232 communication, USB)
Input/output board	N	None (only when need the standard body)
	1	Digital input (DI) 8 contacts, Digital output (DO) 8 contacts, Transistor output (DO) 8 contacts
Language	N	Korean/English (Standard type). No code indication.
	1	English/Chinese (simplified)

Temperature Controllers

TD300 Programmable Temperature Controllers

Specifications

Model		TD300
Appearance		
W×H×D (mm)		96.0×96.0×100.0
Power voltage		100 - 240 V a.c. 50/60 Hz Max. 10 W (voltage fluctuation rate: ±10 % of power voltage)
Screen		3.5" TFT-LCD and touch panel interface
Program		Up to 100 patterns, individual pattern operation possible for each channel / Up to 2,400 segments (up to 100 segments per pattern)
Input (2 channels)	Pt100 (IEC751)	-200.0 ~ 640.0 °C, ± 0.1 % of FS
	TC_K	-200.0 ~ 1,370.0 °C, ± 0.1 % of FS
	TC_J	-200.0 ~ 1,200.0 °C, ± 0.1 % of FS
	TC_E	-200.0 ~ 1000.0 °C, ± 0.1 % of FS
	TC_T	-200.0 ~ 400.0 °C, ± 0.1 % of FS
	TC_R	0 ~ 1,700.0 °C, ± 0.1 % of FS
	TC_S	0 ~ 1,700.0 °C, ± 0.1 % of FS
	mV	0 - 100 mV or -10 - 20 mV (-999.9 ~ 9999.9), ± 0.1 % of FS
	VDC	0 - 10 V (the signal range can be set, -999.9 ~ 9999.9), ± 0.1 % of FS
4 - 20 mA	4 - 20 mA : 250 Ω using the external resistor, V d.c. 1 ~ 5 V using after setting	
Sampling cycle		500 ms
Output	Control output	2 contacts for each channel (heating/cooling)
	Voltage pulse output (SSR)	24 V d.c. Pulse (load resistance min. 600 Ω), minimum pulse width : 10 ms
	Current output (SCR)	4 - 20 mA d.c. (load resistance max. 600 Ω)
	Relay output	NO → 250 V a.c. 5 A / 30 V d.c. 5 A
Communication	Protocol	PCLINK, Modbus-ASCII
	Specifications	● RS232C : 9600 ~ 38400 bps max. 10 m ● RS422/485 : 9600 ~ 38400 bps max. 1.2 km 256 Mode
Ambient temperature & humidity		0 ~ 50 °C, 20 ~ 90 % RH (without condensation)
Weight		Approx. 850 g

Suffix code

Model	Code	Content
TD300	<input type="checkbox"/> <input type="checkbox"/>	2-Channel Programmable Temperature Controller
Communication	1	RS485/422
	2	RS232C
Language	1	Korean/English (standard type)
	2	English/Chinese (simplified)

Temperature Controllers

TH500 Programmable Temperature & Humidity Controllers

Specifications

Model		TH500	
Appearance			
W×H×D (mm)		183.0×144.0×93.5	
Program		100 patterns (1 pattern / 100 segments) max. 6000 segments	
Screen		Color STN LCD (115.17 X 86.37 mm : 5.7")	
Functions		Pattern repetition: max. 999 times, partial repetition: max. 255 / pattern link and edit	
Power voltage		100 - 240 V a.c. 50/60 Hz (voltage fluctuation rate: ±10 %)	
Input	Sampling cycle	500 ms	
	Measuring range	Temperature	-100.00 ~ 200.00 °C
		Humidity	0.0 ~ 100.0 % RH
	Display accuracy	● Temperature: ±0.1 % of FS ● Humidity: ±1 % of FS	
Input type	Pt 100 Ω, 0 (1) - 5 V d.c. or 4 - 20 mA d.c. (external resistance: 250 Ω)		
Output	Control output	SSR output	Min. 24 V d.c. (minimum pulse width: 0.2 ms)
		Current output	4 - 20 mA d.c.
	Retransmission output	● Temperature: 1 contact ● Humidity: 1 contact. Present value (PV), Set value (SV), output volume (MV) Random selection 4 - 20 mA load resistance: max. 600 Ω	
	Contact input	DI : 8 contacts	
Output	Max. 20 contacts (relay 12 contacts, open collector 8 contacts or relay 20 contacts)		
Contact output type		Inner signal : 8 contacts, Alarm signal : 4 contacts each channel, Run/Stop signal : 1 contact, 1st Ref. signal : 1 contact, 2nd Ref. signal : 1 contact Temperature / Humidity Up/Down ● Soak signal: 6 contacts Temp./Humi. Control signal: 2 contacts ● Time signal : 8 contacts / 1 segment ● Error signal : 1 point ● Sensor disconnection signal : 1 point ● Wait signal : 1 point ● Hold signal : 1 point ● PT End signal: 1 signal	
Communication output		● RS485 communication distance: approx. within 1.2 km ● Max. number of connections: 32 ● Communication speed: max. 115,200 bps RS232, RS422/485	
Storage		Internal FLASH memory, temperature/Humidity each 86,400 contacts	
Storage functions		Program information, set value save, recovery, temperature & humidity set / present value save	
Ambient temperature & humidity		0 ~ 50 °C, 10 ~ 90 % RH (without condensation)	
Weight		Approx. 2.35 kg	

Suffix code

Model	Code	Content	
TH500-	<input type="checkbox"/> <input type="checkbox"/> <input type="checkbox"/>	Programmable Temperature & Humidity Controller	
Types	1	Standard type	Temperature & humidity retransmission output Temperature & humidity control output (SSR/SCR drive) Temperature & humidity signal input External digital input (DI): 8 contacts Digital output (DO): relay 12 contacts, open collector 8 contacts Communication specifications: RS232, RS422/485, USB
	2	Detachable type	※ Input and output boards are separated from the main body Temperature & humidity retransmission output Temperature & humidity signal input Communication specifications: RS232, RS422/485 2CH, USB (PV Backup)
	N	-	No body part
Detachable board (optional)	1	Input/Output board-1 (12 contacts Relay output), temperature/humidity control output (SSR/SCR drive) DI : 8 contacts, DO : 12 contacts Relay output, external power supply 24 V d.c. 18 W	
	2	Input/Output board-2 (8 contacts open collector output external terminal board)	
	3	Input/Output board-3 (8 contacts Relay output board)	
	4	(Input/Output board-1) + (output board-2)	
	5	(Input/Output board-1) + (output board-3)	
	N	No output board (when select the main body)	
Language	N	Korean/English (standard type)	
	2	English/Chinese (simplified)	
	3	English/Chinese (traditional)	

Temperature Controllers

TH510 Programmable Temperature & Humidity Controllers

Specifications

Model		TH510		
Appearance				
W×H×D (mm)		145.0×145.0×33.5		
Power voltage		100 - 240 V a.c. voltage fluctuation rate ±10 %		
Power frequency		50/60 Hz		
Power consumption		Max. 30 V A		
Dielectric strength		<ul style="list-style-type: none"> ● Between 1st and 2nd terminals: Min. 1500 V a.c. for 1 min ● Between 1st and FG terminals: Min. 1500 V a.c. for 1 min ● Between 2nd and FG terminals: Min. 1500 V a.c. for 1 min 		
Input type		<ul style="list-style-type: none"> ● 2 types of RTD (Pt-100, KPt-100) ±0.1 % of FS ±1 Digit ● 2 types of DC voltage (1 - 5 V, 0 - 30 V) ±0.1 % of FS ±1 Digit 		
Sampling cycle		250 ms		
Contact outputs (DO)	Relay contact max. 32 contacts	A contact	Max. 30 V d.c. 3 A, 250 V a.c. 3 A	
		B contact	NO: max. 30 V d.c. 5 A, 250 V a.c. 5 A	
Control output	SSR output	ON: 18 V d.c. pulse voltage (load resistance min. 800 Ω)		
	SCR output	4 - 20 mA d.c. (load resistance max. 600 Ω)		
Retransmission output	Current output	4 - 20 mA d.c.		
	Load resistance	load resistance max. 600 Ω		
	Output type	Present value (PV), Set value (SV), output volume (MV), Random selection		
	Refresh interval	250 ms		
Functions	Input type	Input calibration (sensor bias)	Temperature 1 contact: EUS (0 ~ 100%) Humidity 1 contact: EUS (0 ~ 100%)	
		Dry/wet bulb sensor compensation	Compensate the difference between the wet and dry bulb sensor after removing the wet bulb sensor gauze.	
		Scaling (Scaling)	DC voltage (VDC): Input scaling according to conversion range	
		Input filter (LPF)	0 ~ 120 sec	
	Control mode	Operation type	Constant-value / Program control	
	Control output	Temperature control output	Output (SSR) or current output (4 - 20 mA d.c.) selection	
		Humidity control output		
	Control operation	Pattern	100 patterns (1 pattern / 100 segments)	
		Segment	2000 Segment	
		PID group	16 groups (temperature 4 zones X humidity 4 zones)	
Auto-tuning		Auto-tuning according to target set value		
Proportional band		0.00 ~ 100.00 % (for 0.00 %, ON/OFF control)		
Integral time		0.0 ~ 3000 sec. (OFF status when 0 sec is set)		
Derivative time				
ON/OFF control	Set 0.0 to proportional band (PB)			
Re-transmission output	Temperature, Humidity	Current output (4 - 20 mA d.c.) Present value (PV), Set value (SV), output volume (MV) selection		
	Scaling	Automatic scaling of set high and low range (4 - 20 mA d.c.)		
Alarm setting	Setting alarm	System alarm: 8 contacts Assign 4 of 8 pattern alarms to a pattern		
	Alarm type	High/Low absolute, High/Low deviation, Within/Out of range (alarm direction,hold)		
	Absolute alarm setting range	EU (0 ~ 100 %)		
Display		TFT color LCD (115.2 × 86.4 mm)		
Resolution		640 × 480 pixel		
Back light		LED back light		
Back light life		Approx. 40,000 h		
Touch type		Resistive type (4 Wires)		
Language		Korean/English/Chinese (simplified)		
Saving functions	Internal memory	Non-volatile memory: 80 MB		
	External memory	SD card (4 GB)		
	Saving interval	1 ~ 360 sec		
Memory information		Program information, set value, recovery, temperature set / process / output value		
Ambient temperature & humidity		0 ~ 50 °C, 20 ~ 90 % RH (without condensation)		
Weight		Approx. 1.32 kg		

Temperature Controllers

Suffix code

Model	Code	Content
TH	<input type="checkbox"/> 1 <input type="checkbox"/> 0 - <input type="checkbox"/> <input type="checkbox"/> <input type="checkbox"/>	Programmable Temperature & Humidity Controller
Display part	5	5.7" TFT-LCD
Input/output	1	8 input contacts.6 output contacts (1 module)
	2	8 input contacts.14 output contacts (2 module)
	3	16 input contacts.16 output contacts (3 modules)
Language	S	Korean, English and Chinese (simplified)
	T	Korean, English and Chinese (traditional)
Communication		RS485
	E	RS485, Ethernet

※ Basic components (power module, Control module)

※ This product consists of power module/control module/Input module/output module 32 contacts, (digital input (DI) with up to 32 contacts, digital output (DO) with up to 32 contacts).

Components

Product	Model	Content
Display part	TH510-1N□	Display part (5.7" TFT LCD)
Control module	TH510-MAIN	Temperature & Humidity Control Module
Power module	TM-PWR	Power module
Input module	TM-DI	Module with 16 input contacts
Output module	TM-DO	Module with 8 output contacts
Input/output module	TM-DIO	Module with 8 input and 6 output contacts

TH300 Programmable Temperature & Humidity Controllers

Specifications

Model	TH300	
Appearance		
W×H×D (mm)	96.0×96.0×100.0	
Program	100 Pattern (100 segments / 1 pattern) max. 2000 segments	
Screen	TFT LCD 70.08 × 52.56 mm (3.5")	
Functions	Contact input (DI): 4 contacts, Contact output (DO): max. 12 contacts, RS232/485	
Power voltage	100 - 240 V a.c. 50/60 Hz (voltage fluctuation rate: ±10 %)	
Display accuracy	● Temperature (°C): ±0.2 % of FS ● Humidity (%RH): ±2 % of FS	
Sampling cycle	500 ms	
Input type	Pt100 Ω or 0 - 5 V d.c.	
Output	Control output (OUT)	● ON: 24 V d.c. pulse voltage ● OFF : 0.1 V d.c. max. ● Pulse voltage (load resistance min. 800 Ω) ● Cycle time: 1 ~ 1000 sec
	Retransmission output (RET)	● Temperature / humidity : 4 - 20 mA d.c. (load resistance max. 600 Ω) present value (PV), output volume (MV), set value (SV) ※by internal selection ● Resolution: approx. 7,000 ● Refresh interval : 500 ms
	Contact output (DO)	● Relay : 8 contacts (1a X 8 contacts), N.O : 30 V d.c. 5 A, 240 V a.c. 5 A ● Transistor: 4 contacts (open collector output). 24 V d.c. 300 mA max
Control type	PID auto-tuning	
Ambient temperature & humidity	0 ~ 50 °C, 20 ~ 90 % RH (without condensation)	
Weight	Approx. 850 g	

Suffix code

Model	Code	Content
TH300	<input type="checkbox"/> <input type="checkbox"/>	Programmable Temperature & Humidity Controllers
Communication	1	RS232C communication
	2	RS485/422 communication
Language	1	Korean/English (standard type)
	2	English/Chinese (simplified)
	3	English/Chinese (traditional)

Temperature Controllers

NP200 Programmable Temperature Controllers

Specifications

Model		NP200
Appearance		
W×H×D (mm)		96.0×96.0×100.0
Power voltage		100 - 240 V a.c. 50/60 Hz, voltage fluctuation rate: ±10 %
Power consumption		Max. 6.0 W / max. 10 VA
Input (Multi Input)	Thermocouple input	K, J, E, T, R, B, S, L, N, U, W, PLII,
	RTD	Pt100 (KS/IEC 751), KPt100 (KS)
	DC voltage input	1 - 5 V d.c. 0 - 10 V, -10 - 20 mV, 0 - 100 mV
	DC Current input	4 - 20 mA (attach 250 Ω external resistor)
Control output		Relay output, voltage output (SSR), current output (SCR)
Control operation		PID control, ON/OFF control
Alarm type		High/Low, High/Low deviation
Communication method		RS485/422, 2-wire half-duplex or 4-wire half-duplex (by wiring method)
Setting		By front Shift up, Down keys
Display		PV : Digital LED, SV : Graphic LCD
Accuracy		0.1 % of FS (Full Scale)
Setting accuracy		1 or 0.1 % (according to input range)
External control		4 alarm outputs (Run, Reset, Step, Hold)
Pattern		30 patterns, Up to 99 segments per pattern can be set
Segment		300 Segment
Set time unit of program		Hours, minutes or minutes, seconds
Sampling cycle		100 ms
Insulation Resistance		Min. 500 V a.c. 20 MΩ
Dielectric strength		2300 V a.c. 50/60 Hz for 1 min (between 1st and 2nd terminals and between 1st terminal and ground)
Ambient temperature & humidity		0 ~ 50 °C, 35 ~ 85 % RH (without condensation)
Weight		Approx. 696 g

Suffix code

Model	Code	Content
NP200	<input type="checkbox"/> <input type="checkbox"/>	Programmable Temperature Controller
Control type	0	Normal type (heating)
	1	Heating/cooling type (synchronous control type)
Option	0	None (basic specifications: contact input 3 contacts, user output 10 contacts)
	1	Communication function (RS485/422)
	2	Contact input 4 contacts
	3	Communication (RS485/422) + contact input 4 contacts

※ Contact input 4 contacts: (DI-4) ~ (DI-7)

Temperature Controllers

NP100 Programmable Temperature Controllers

Specifications

Model		NP100
Appearance		
W×H×D (mm)		96.0×96.0×100.0
Power voltage		100 - 240 V a.c. 50/60 Hz
Power consumption		Max. 10 VA
Input (Multi Input)	TC	K, J, E, T, R, B, S, L, N, U, W, PLII
	RTD	Pt100 (KS/IEC 751), KPt100 (KS)
	DC voltage input	1 to 5 V, 0 to 10 V, -10 to 20 mV, 0 to 100 mV
	DC Current input	4 - 20 mA (attach 250 Ω external resistor)
Control output		Relay output, voltage output (SSR), current output (SCR)
Control operation		PID control, ON/OFF control
Alarm output		2 contacts (High/Low, High/Low deviation, Pattern end alarm, etc.)
Communication		RS 485/422 (optional)
Setting		By front Shift up, Down keys
Display		PV/ SV : Digital LED
Display accuracy		0.1 % of FS (Full Scale)
Input display resolution		By default, below the decimal point of the range
External control		3 external controls (Run, Reset, Hold)
Pattern, Segment		2 pattern, 20 segments (10 segments per pattern)
Operation		1 ~ 99 times or limitless
Set time unit of program		hours, minutes
Input sampling cycle		250 ms
Insulation resistance		Min. 20 MΩ, 500 V d.c. (between 1st and 2nd terminals, between 1st terminal and ground, between 2nd terminal and ground)
Dielectric strength		2300 V a.c. 50/60 Hz for 1 min (between different live parts)
Ambient temperature & humidity		0 ~ 50 °C, 35 ~ 85 % RH (without condensation)
Weight		696 g

Suffix code

Model	Code	Content
NP100	<input type="checkbox"/> <input type="checkbox"/>	Programmable Temperature Controller
Control type	0	Normal type (heating)
Option	0	None (basic specifications: contact input 3 contacts, alarm output 10 contacts)
	1	Time signal 2 contacts
	2	Communication (RS485/422)
	3	Time signal 2 contacts and communication (RS485/422)

Temperature Controllers
Recorders
Digital Counter/ Timers
Analog Timers
Multi Pulse Meters
Panel Meters
Peripheral Devices
Proximity Sensors
Photo Sensors
Rotary Encoders
Thyristor Power Regulators
Solid State Relays
Power Supplies
Control Switches / Combination Display Lights
Power / Main / Cam Switches
Limit Switches
Micro Switches
Foot / Mono Lever / Pendant Switches
Signal Lights
Power Buzzers / Terminal Blocks Fuse Holders / Control Boxes

Temperature Controllers

■ TS510 Thermal Shock Test Controllers

■ Specifications

Model		TS510		
Appearance				
W×H×D (mm)		145.0×145.0×33.5		
Power voltage		100 - 240 V a.c. voltage fluctuation rate ±10 %		
Power frequency		50/60 Hz		
Power consumption		Max. 30 VA		
Dielectric strength		<ul style="list-style-type: none"> Between 1st and 2nd terminals: min. 1500 V a.c. for 1 min. Between 1st terminal and FG: min. 1500 V a.c. for 1 min Between 2nd terminal and FG: min. 1500 V a.c. for 1 min 		
Input type		<ul style="list-style-type: none"> Thermocouple 11 types (K, J, E, T, R, B, S, L, N, U, Wre 5-26) ±0.15 % of FS ±1 digit RTD 2 types (Pt-100, KPt-100) ±0.1 % of FS ±1 Digit Current voltage 4 types (-10 - 20 mV, 0 - 100 mV, 1 - 5 V, 0 - 30 V) ±0.1 % of FS ±1 Digit 		
Sampling cycle		250 ms		
Contact outputs (DO)	Relay contact max. 32 contacts	A contact	Max. 30 V d.c. 3 A, 250 V a.c. 3 A	
		B contact	NO: max. 30 V d.c. 5 A, 250 V a.c. 5 A	
Control output	SSR output	ON: 18 V d.c. pulse voltage (load resistance min. 800 Ω)		
	SCR output	4 - 20 mA d.c. (load resistance max. 600 Ω)		
Retransmission output	Current output	4 - 20 mA d.c.		
	Load resistance	load resistance max. 600 Ω		
	Output type	Laboratory PV, Laboratory SV, hot chamber PV, cold chamber PV		
	Refresh interval	250 ms		
Input	Input correction	EUS (0 ~ 100 %)		
	Input filter	0 ~ 120 sec		
Functions	Control output		Output (SSR) or current output (4 - 20 mA d.c.) selection	
	Control operation	Test pattern	Max. 100, test type (10 types) selection per each pattern	
		PID group	Hot chamber/cold chamber each 4 groups, deviation PID	
		Auto-tuning	Auto-tuning according to target set value	
		Proportional band	0.00 ~ 100.00 % (for 0.00 %, ON/OFF control)	
		Integral time/ Derivative time	0.0 ~ 3000 sec. (OFF status when 0 sec is set)	
		ON/OFF control	Set 0.0 to proportional band (PB)	
		Direct/reverse action	Depending on the direct/reverse action selection of the control output	
	Direct/reverse action	ARW zone setting (50 ~ 1000 % of proportional band)		
	A.T GAIN	0.0 ~ 10.0		
Alarm setting	Setting alarm	System alarm 8 contacts		
	Alarm type	High/Low absolute, High/Low deviation, Within/Out of range (alarm direction, hold)		
	Absolute alarm setrange	EU (0 ~ 100 %)		
Display		TFT color LCD (115.2 × 86.4 mm)		
Resolution		640 × 480 pixel		
Back light		LED back light		
Back light life		Approx. 40,000 h		
Touch type		Resistive type (4 Wires)		
Language		Korean/English/Chinese (simplified)		
Saving functions	internal memory	Non-volatile memory: 80 MB		
	External memory	SD card (4 GB)		
	Saving interval	1 ~ 360 sec		
Memory information		Program information, set value, recovery, temperature set / process / output value		
Ambient temperature & humidity		0 ~ 50 °C, 20 ~ 90 % RH (without condensation)		
Weight		Approx. 1.32 kg		

■ Suffix code

Model	Code	Content
TS510-	<input type="checkbox"/> <input type="checkbox"/> <input type="checkbox"/>	Thermal Shock Test Controller
Display part	1	5.7" TFT-LCD
	N	None
Input/output	1	16 input contacts · output 8 contacts (2 modules) + power module + control module
	2	16 input contacts · 16 output contacts (3 modules) + power module + control module
	3	16 input contacts · output 24 contacts (4 modules) + power module + control module
	N	No input/output
Language	S	Korean, English and Chinese (simplified)
	T	Korean, English and Chinese (traditional)

■ Components

Product	Model	Content
Display part	TS510-1N□	Display part (5.7" TFT LCD)
Control module	TS510-MAIN	Temperature 3-channel control module
Power module	TM-PWR	Power module
Input module	TM-DI	Module with 16 input contacts
Output module	TM-DO	Module with 8 output contacts
Input/output module	TM-DIO	Module with 8 input and 6 output contacts

※ This product basically consists of display and control parts (power, control, input, output modules). Digital input (DI) with up to 32 contacts, digital output (DO) with up to 32 contacts

Temperature Controllers

SM100 Board Type Multi Channel Temperature Controllers

Specifications

Model		SM100-□□12	SM100-□□16	SM100-□□20	
Appearance					Temperature Controllers
Number of channels		12 channels	16 channels	20 channels	Recorders
Measurement input	Input type	Thermocouple (K), range: -199.9 °C ~ 999.9 °C / RTD (Pt100 Ω), range: -199.9 °C ~ 640.0 °C			Digital Counter/ Timers
	Display accuracy	±0.5 % of max. range (± 0.5 % of FS)			Analog Timers
	RJC compensation accuracy	Within display accuracy			
	Sampling cycle	1 sec.			
	Input correction	-1,200.0 °C ~ 1,200.0 °C			
	Input filter	0.0 ~ 120.0 sec.			
	Burn-out operation	Thermocouple: Upscale RTD : Upscale			
Settings and display	Setting method	Setting by communication program			Multi Pulse Meters
	Number of settings	12 contacts	16 contacts	20 contacts	
	Memory storage	Storage by semiconductor			Panel Meters
	Device address setting	Setting by built-in HEX BCD switch (1 to 15)			
Display LED	Power indication, communication indication, control output indication				
Control output	Output	SSR driving voltage pulse output (driving voltage: 12 V d.c., load resistance min. 600 Ω)			Peripheral Devices
	Control operation	Time proportional PID or ON/OFF control			
	Number of PID groups	1 group / channel			
	Proportional cycle (output cycle)	1 sec. ~ 100 sec.			
	Proportional band (P)	0 ~ 1,200.0 °C			
	Integral time (I)	1 ~ 3,600 sec.			
	Derivative time (D)	1 ~ 3,600 sec.			
	ARW (Anti Reset Wind-up)	0.1 ~ 100.0 % ※ "0" setting (Auto)			
	Manual reset	0.0 ~ 100.0 % (During ON/OFF control)			
	Hysteresis	0 ~ 120.0 °C (During ON/OFF control)			
	Control output operation	Cooling control (direct action) / heating control (reverse action) selection			
Contact input	Emergency output	0.0 ~ 100.0 %			Rotary Encoders
	Number of external contact inputs	1 contact (RUN/STOP by built-in dip switch)			
Communication specifications	Communication standard	RS485/422 (4-wire type)			Thyristor Power Regulators
	Communication method	Half-duplex			
	Max. number of connections	15 \square ※Address setting by HEX BCD switch			
	Communication sequence	No sequence			
	Start bit	1 Bit			
	Stop bit	1 Bit			
	Parity bit	Even			
	Data length	8 Bit			
	Transmission speed	19200 bps			
	Communication distance	1.2 km max			
Communication protocol	PC Link with SUM			Solid State Relays	
Response time	Reception handling time + (response setting time × 25 ms)				
Power voltage	100 - 240 V a.c. 50/60 Hz (±10% of rated power voltage)			Power Supplies	
Power consumption	2max. 5 VA				
Insulation resistance	Min. 20 MΩ. between power terminal and ground (500 V d.c. Mega)				
Dielectric strength	2000 V a.c. for 1 min (between power terminal and ground)				
Ambient temperature & humidity	0 ~ 50 °C, 20 ~ 85 % RH (without condensation)				
Storage temperature	-20 °C ~ 70 °C				
Vibration resistance	10 - 55 Hz 19.6 m/s ² 3 axes 6 directions 2 h				
Shock resistance	196 m/s ² 3 axes 6 directions each 3 times				
Case material	Cold rolled steel plate (SPC)				
Weight	Approx. 1000 g			Control Switches / Combination Display Lights	

Suffix code

Model	Code	Content	
SM100-	□ □ □	Multi-channel Board Type Temperature Controller (basic specifications: alarm output 3 contacts, built-in run/stop SW 1 contact, RS485/422)	
Input type	K	K(CA) thermocouple input (IEC 584-1)	Signal Lights
	P	Pt100 ΩRTD input (IEC 751)	
Output form	A	Control output (SSR driving voltage pulse output)	Power Buzzers / Terminal Blocks Fuse Holders / Control Boxes
	N	No control output (Indication only)	
Number of control contacts (Number of channels)	20	20 channels (standard product)	
	16	16 channels	
	12	12 channels	

Temperature Controllers

MC9 Multi-Channel Digital Temperature Controllers

Specifications

Model		MC9	
Appearance			
W×H×D (mm)		96.0×96.0×100.0	
Input	Thermocouple	K, J, R, S, B, E, N, T, W, PL2, U, L	
	RTD	Pt100 Ω, KPt100 Ω	
	DC voltage	0 - 5 V, 1 - 5 V, 0 - 10 V, 4 - 20 mA (attach 250 Ω external resistor)	
	Sampling cycle	1 sec	
	Input display resolution	Basically, below the range decimal point	
	Input impedance	Thermocouple and DC voltage input: min. 1 MΩ	
	Allowable input resistance	Approx. 0.2 μV/Ω	
	Allowable input lead resistance	RTD (max. 10 Ω, but the resistance among 3 lines should be same)	
	Allowable input voltage	Within -2 - 5 V (thermocouple, RTD), within -5 to 12 V (DC voltage)	
	Scaling	0.0 % ~ 100.0 % of FS	
	Input correction	±100 % of FS	
	Reference contact compensation error	±1.5 °C (0 ~ 50 °C range)	
Input disconnection detection		UP SCALE (reverse action), DOWN SCALE (direct action)	
Performance	Degree of indication	Thermocouple	Bigger between ±0.3 % of FS ±1 Digit or ±2 °C
		RTD	Bigger between ±0.3 % of FS ±1 Digit or ±0.8 °C
		DC voltage	±0.3 % of FS ±1 Digit
	Insulation Resistance	min. 20 MΩ (500 V d.c.), measuring terminal - power terminal	
Dielectric strength	2300 V a.c. 50/60 Hz for 1 min measuring terminal - power terminal		
Control function and output	Control type	PID auto-tuning	
	Simultaneous channel setting	4/8 channels simultaneous setting of the same value	
	Control operation	a) Reverse action (heating) / direct action (cooling). by "suffix code" b) Heating/cooling simultaneous control (4 channels only)	
	Setting range	Same as range and input code	
	Digital input (DI)	RUN/STOP or control zone selection by contact input	
	Auto-tuning	Auto-tuning by parameter selection	
	Proportional band	0 (0.0) to the maximum value of range	
	Integral time	1 ~ 3,600 sec	
	Derivative time	1 ~ 3,600 sec	
	ARW (Anti Reset Wind-up)	Auto, 0 ~ 100 % (proportional band)	
	Gradient setting	0 (0.0) to max. range/1 min (gradient setting for target value)	
	Scan function	Displays the measured value and set value for each channel sequentially	
	ON/OFF control	Set the proportional band to "0"	
	Multi-memory zone	8 zone selection for each channel	
	Heater break alarm (HBA)	0.0 - 100.0 A (ON/OFF control, can be used on time proportional control output)	
	HBA dead band setting	0 ~ 100 sec.	
	Loop break alarm (LBA)	0.1 ~ 200.0 min (dead band : 0 ~ 100 sec.)	
	Alarm output	Up to 3 contacts, parallel (OR) operation for all channels (by selected specifications)	
Alarm type	Selection by parameter		
Control output	Relay output	<ul style="list-style-type: none"> ● Contact capacity: 1 a, 250 V a.c. 3 A (resistive load) ● Proportional period: 1 ~ 1000 sec ● Time resolution: Lower between 0.1 % or 10 ms 	
	Voltage output (SSR)	<ul style="list-style-type: none"> ● Voltage pulse: approx. min. 12 V d.c. (load resistance min. 600 Ω) ● Proportional period: 1 ~ 1000 sec ● Time resolution: Lower between 0.1 % or 10 ms 	
	Current output (SCR)	<ul style="list-style-type: none"> ● Current: 4 - 20 mA d.c., 0 - 20 mA (load resistance max. 600 Ω) ● Accuracy: ±1.0 % of FS (4 - 20 mA range) 	
Alarm output (relay)	Triac	200 V a.c. 0.5 A (Ambient temperature 40 °C max), Zero Crossing function	
	Temperature alarms (AL1,2,3)	1 a, 250 V a.c., 1 A, 30 V d.c. 1 A (resistive load) / Output points: Max. 3 points (by selected specifications)	
	Heater break alarm (HBA)	<ul style="list-style-type: none"> 1 a 1 contact, 250 V a.c., 1 A, 30 V d.c. 1 A (resistive load) ● Measuring current: 1 - 100 A a.c. (resolution: 0.5 A, ± 5 % of FS ± 1 Digit) ● CT for heater break detection: Model name JS81L (J&D Electronic.Co.Ltd) ● Accuracy: bigger between ±5 % of FS or ±2 A 	
Loop break alarm (LBA)	1 a 1 contact, 250 V a.c., 1 A, 30 V d.c. 1 A (resistive load) / Proportional period: 1 ~ 1000 sec		
Power voltage	100 - 240 V a.c. 50/60 Hz		
Voltage fluctuation rate	±10 % of power voltage		
Power consumption	12 VA		
Ambient temperature & humidity	0 ~ 50 °C, 35 ~ 85 % RH (without condensation)		
Storage temperature	-25 ~ 65 °C		
Vibration resistance	10 - 55 Hz, single amplitude 0.75 mm, 3 axes each direction, 2 h		
Shock resistance	300 m/s, 3 axes each direction, 3 times		
Weight	Approx. 700 g		

Temperature Controllers

Suffix code

■ MC9 (4 channels)

Model	Code	Content
MC9-4	<input type="checkbox"/> <input type="checkbox"/> <input type="checkbox"/> <input type="checkbox"/> <input type="checkbox"/> <input type="checkbox"/>	4-Channel Digital Temperature Controllers
Control Type	D	For cooling control (direct action)
	R	For heating control (reverse action)
	W	Heating cooling simultaneous control
Input type	<input type="checkbox"/>	Refer to input type code
Heating output (output 1 ~ 4)	M	Relay contact output
	S	Output for SSR drive
	T	Output for Triac drive
	4	Current output (4 - 20 mA d.c.)
	5	Current output (0 - 20 mA d.c.)
Cooling output (output 5~8) * if control types are D and R then fix to N * if control type is W then select among M,S, t, 4 and 5	N	None (if control output operation is DR)
	M	Relay contact output
	S	Output for SSR drive
	T	Output for Triac drive
	4	Current output (4 - 20 mA d.c.)
5	Current output (0 - 20 mA d.c.)	
Option	N	None
	1	AL2, AL3
	2	AL2, AL3 + RS232 + contact input
	3	AL2, AL3 + RS485 / 422 + contact input
4	AL2, AL3 + heater break	
Power voltage	2	100 - 240 V a.c. 50/60 Hz

■ MC9 (8 channels)

Model	Code	Content
MC9-8	<input type="checkbox"/> <input type="checkbox"/> <input type="checkbox"/> <input type="checkbox"/> <input type="checkbox"/> <input type="checkbox"/>	8-Channel Digital Temperature Controllers
Control Type	D	For cooling control (direct action)
	R	For heating control (reverse action)
Input type	<input type="checkbox"/>	Refer to "Range and input code chart"
Heating output (output 1 ~ 4)	M	Relay contact output
	S	Output for SSR drive
	T	Output for Triac drive
	4	Current output (4 - 20 mA d.c.)
	5	Current output (0 - 20 mA d.c.)
Cooling output (output 5~8) * if control types are D and R then fix to N * if control type is W then select among M,S, t, 4 and 5	N	None (when selected, input channels 5 ~ 8 are for indication)
	M	Relay contact output
	S	Output for SSR drive
	T	Output for Triac drive
	4	Current output (4 - 20 mA d.c.)
5	Current output (0 - 20 mA d.c.)	
Option	N	None (alarm output AL1, 2, 3 built-in)
	2	RS232 + contact input
	3	RS485 / 422 + contact input
	4	Heater break
Power voltage	2	100 - 240 V a.c. 50/60 Hz

Range and input code chart

Classification	Code	Input type	Range (°C)	Accuracy
Thermocouple	K0	K	-200 ~ 1370	Bigger between $\pm 0.3\%$ of FS ± 1 Digit or ± 2 °C
	K1	K	-199.9 ~ 999.9	
	J0	J	-200 ~ 1200	
	J1	J	-199.9 ~ 999.9	
	E0	E	-199.9 ~ 999.9	
	E1	E	-199.9 ~ 999.9	
	T0	T	-199.9 ~ 400.0	
	R0	R	0 ~ 1700	
	R1	R	0.0 ~ 999.9	
	B0	B	0 ~ 1800	
	B1	B	0.0 ~ 999.9	
	S0	S	0 ~ 1700	
	S1	S	0.0 ~ 999.9	
	L0	L	-199.9 ~ 900.0	
	N0	N	-200 ~ 1300	
	N1	N	-199.9 ~ 999.9	
U0	U	-199.9 ~ 400.0		
W0	W	0 ~ 2300		
A0	PL2	0 ~ 1390		
RTD	P0	KPt100 Ω	-199.9 ~ 500.0	Bigger between $\pm 0.3\%$ of FS ± 1 Digit or ± 0.8 °C
	D0	Pt100 Ω	-199.9 ~ 600.0	
DC voltage	V0	0 - 5 V	-199.9 ~ 999.9	$\pm 0.3\%$ of FS ± 1 Digit
	V1	1 - 5 V	-199.9 ~ 999.9	
	V2	0 - 10 V	-199.9 ~ 999.9	

※ When using current input, please attach 250 Ω 0.1% resistor to input signal terminal

Temperature Controllers

ML Multi-Channel Modular Temperature Controllers

Specifications

Model		ML-D4	ML-D2H	ML-E
Appearance				
W×H×D (mm)		30.0×100.0×96.9		
Power voltage		24 V d.c.		
Voltage fluctuation rate		±10 % of power voltage		
Power consumption		ML-D4S/C Max. 7W	ML-D4M Max. 5W	ML-E Max. 3W
Input (Multi Input)	Thermocouple	K, J, E, T, R, B, S, L, N, U, W, PL2		
	RTD	Pt100 Ω, KPt100 Ω		
	DC voltage	0 - 100 mV, 1 - 5 V, 0 - 10 V		
	Sampling cycle	50 ms		
	Input display resolution	Below minimum unit of input range		
	Input impedance	Thermocouple and DC voltage input: min. 1 MΩ		
	Allowable input resistance influence	Approx. 0.2 uV/Ω		
	Allowable input lead resistance	RTD (max. 10 Ω. but the resistance among 3 lines should be same)		
	Allowable input voltage	Within -2 - 5 V (thermocouple, RTD), within -5 to 12 V (DC voltage)		
	Input correction	±100% of input range		
	Reference junction compensation error	±1.5 °C (0 ~ 50 °C)		
Input disconnection detection (Burn-out)	Up scale			
Control output	Relay (RELAY)	1A contact 250 V a.c. 3 A, 30 V d.c. 3 A		
	Voltage output (SSR)	Approx. 12 V min (load resistance min. 600 Ω) with short-circuit, limit to about 25 mA Time resolution: bigger between control cycle 0.1 % or 10 ms		
	Current output (SCR)	4 - 20 mA d.c. (load resistance max. 600 Ω) Accuracy: ±0.1 % of FS (4 - 20 mA range)		
RS232C communication	Communication method	RS232 standard		
	Max. communication distance	15 m		
	Communication speed	9600 bps		
	Start bit	1 bit		
	Data length	8 bit		
	Parity bit	Even		
	Stop bit	1 bit		
	Supported protocol	PC-Link		
RS485 communication	Communication method	RS485 standard / 2-wire half-duplex		
	Max. number of connections	31 units		
	Max. communication distance	1200 m		
	Communication sequence	No sequence		
	Communication speed	9600, 19200, 38400, 57600, 76800 bps [initial value: 9600]		
	Start bit	1 bit		
	Data length	7, 8 bit [initial value: 8]		
	Parity bit	None, odd, even [initial value: even]		
	Stop bit	1, 2 bit [initial value: 1]		
	Response time	Reception handling time + (response time x 10 ms)		
Supported protocol	PC-Link, PC-Link with SUM, Modbus ASCII/RTU [initial value: PC-Link]			
Ambient temperature & humidity	0 ~ 50 °C / 35 ~ 85 % RH (without condensation)			
Operating environment	No toxic gases, magnetic fields or dust generating areas			
Warm-up time	At least 30 min			
Ambient temperature influence	Thermocouple, DC voltage: bigger between ±3 uV / °C or ±0.03 % of FS / °C, RTD : ±0.1 °C / °C max			
Power supply change influence	Bigger between ±3 uV / 10 V or ±0.03 % of FS / 10 V			
Storage temperature & humidity	-25 ~ 65 °C / 5 ~ 95% RH (without condensation)			
Weight	Approx. 220g (box excluded)			

Temperature Controllers

Suffix code

■ Modular Temperature Controllers (ML-D2H)

Model	Code	Content	
ML-D	2 H □	Modular Temperature Controller	
Number of channels	2	2 channels	
Input	H	Heating/cooling control (simultaneous), heater break alarm (HBA)	
Control output	MM	OUT1 (heating)	Relay output
		OUT2 (cooling)	
	SM	OUT1 (heating)	SSR / SCR (4 - 20 mA d.c.) parameter selection output
		OUT2 (cooling)	Relay output
	SS	OUT1 (heating)	SSR / SCR (4 - 20 mA d.c.) parameter selection output
		OUT2 (cooling)	

■ Modular Temperature Controllers (ML-D4)

Model	Code	Content
ML-D	4 □	Modular Temperature Controller
Number of channels	4	4 channels
Control output	M	Relay output
	S	SSR output (12 V d.c.)
	C	SCR output (4 - 20 mA d.c.)

Ex: temperature controller 4 channel relay output: ML-D4M

■ Modular Event Outputs (ML-E)

Model	Content
ML-E	Modular Event Output Unit (8 contacts relay)

Temperature Controllers
Recorders
Digital Counter/ Timers
Analog Timers
Multi Pulse Meters
Panel Meters
Peripheral Devices
Proximity Sensors
Photo Sensors
Rotary Encoders
Thyristor Power Regulators
Solid State Relays
Power Supplies
Control Switches / Combination Display Lights
Power / Main / Cam Switches
Limit Switches
Micro Switches
Foot / Mono Lever / Pendant Switches
Signal Lights
Power Buzzers / Terminal Blocks / Fuse Holders / Control Boxes

Temperature Controllers

VX4 LCD Temperature Controllers

Specifications

Model		VX4	
Appearance			
W×H×D (mm)		48.0×48.0×63.0	
Input	Thermocouple	K, J, E, T, R, B, S, L, N, U, W, PLII	
	Reference junction compensation accuracy	±3.5 °C (within -10~50 °C)	
	RTD	JPT100, PT100	
	Allowable line resistance	Each 3 wire within 10Ω	
	DC voltage / current	1~5 V (4~20 mA), 0~5 V, 0~10 V, 0~50 mV, 0~100 mV	
	Sampling cycle	50 ms	
Control output	Relay output	Rated switching capacity	5A 250 V a.c., 5 A 30 V d.c.
		Max. switching power	750 VA, 90 W
		Max. switching voltage	250 V a.c., 110 V d.c.
		Max. switching current	5 A
		Mechanical life	20 million times (at 180 CPM)
	SSR output	12 V ± 1 V d.c. pulse voltage (load resistance min. 600 Ω)	
SCR output	1 contact, load resistance: max. 600 Ω ± 0.2% of FS ± 1 digit		
Control	Control type	ON/OFF, PID control, 2DOF PID control	
	Output operation	Reverse action, direct action	
Display part	Display method	Wide viewing angle LCD	
	Active area (H X W)	25.7 X 36.2 mm	
	PV character (H X W)	15.2 X 6.8 mm	
	SV character (H X W)	7.4 X 3.9 mm	
	MV character (H X W)	-	
Memory	Non-volatile memory life	EEPROM unlocked: when setting E2P.L: OFF in G.SET group - EEPROM life: 1 million times write guaranteed EEPROM lock setting: when setting E2P.L: ON in G.SET group - store in RAM	
RS485	Communication method	EIAR RS485 standard, 2-wire half-duplex	
	Max. connections	31 (address setting 1~99 available)	
	Communication sequence	No sequence	
	Communication distance	Within 1.2 km	
	Communication speed	4800, 9600, 14400, 19200, 38400, 57600 BPS	
	Start bit	1 bit	
	Data length	7 or 8 bit	
	Parity bit	NONE, EVEN, ODD	
	Stop bit	1 or 2 bit	
	Protocol	PC-LINK STD, PC-LINK SUM, MODBUS-ASCII, MODBUS-RTU	
	Response time	Actual response time = handling time + (response time X 25 ms)	
Loader	Communication method	USB 2.0	
	Protocol	· Protocol : PC-LINK, · Baudrate : 38400 bps, · Start bit : 1 bit, · Data bit : 8 bit, · Parity bit : None, · Stop bit : 1 bit	
	Communication distance	Max. 5 m	
Option	DI	2 contacts or 4 contacts	
	Retransmission output	1 contact, load resistance: max. 600 Ω ± 0.2% of FS ± 1 digit	
	Remote input	1 contact, 4 ~ 20 mA (1 ~ 5 V)	
	Current input	1 contact or 2 contacts	

Temperature Controllers

Power	Power voltage	100 - 240 V a.c., 50/60 Hz
	Voltage fluctuation rate	±10 % of power voltage
	Insulation Resistance	Min. 20 MΩ, 500 V d.c.
	Dielectric strength	2.5 KV a.c. 1 mA 50/60 Hz for 1 min (between 1st and 2nd terminal)
	Power consumption	Max. 8.2 VA
	Ambient temperature & humidity	-10 ~ 50 °C, 35 ~ 85 % RH (without condensation)
	Storage temperature	-25 ~ 65 °C
Ambient	Electrostatic discharge (ESD)	KN61000-4-2
	EFT(RS)	KN61000-4-3
	SURGE	KN61000-4-5
	Conductive RF (CS)	KN61000-4-6
	RE	CISPR11
	CE	CISPR11

Suffix code

Model	Code	Content	
VX	□ - □ □ □ □ □ □ □ □ □ □ □ □	LCD Digital Temperature Controller	
Size	2	48(W) X 96(H) mm	
	4	48(W) X 48(H) mm	
	7	72(W) X 72(H) mm	
	9	96(W) X 96(H) mm	
Sensor	U	Universal input	
OUT1 (Heating)	M	Relay	
	S	SSR	
	C	SCR	
OUT2 (Cooling)	N	None	
	M	Relay	
Power	A	100 - 240 V (a.c), 50/60 Hz	
Option	Sub output	A1	RELAY 1 (standard)
		A2	RELAY 1 & 2
		A3	RELAY 1, 2 & 3 (※ *1, *2)
		A4	RELAY 1, 2, 3 & 4 (※ *2)
	Communication		None
		C	RS485
	Retransmission output		None
		T	4 ~ 20 mA
	DI (Digital Input)		None
		D2	2 contacts (DI 1 ~ 2)
		D4	4 contacts (DI 1 ~ 4)
	CT		None
		H1	CT1
		H2	CT1 & 2
Remote input		None	
	R	4 ~ 20 mA	

※ Regarding the codes available for order, please refer to our website





※ * 1) Not available for VX4. However, when OUT2 = M is selected, ALM3 can be used according to the parameter setting.

※ * 2) You can select from VX2, 7, 9 (VX4 is excluded)

Temperature Controllers

HX series Multi Input/Output Digital Temperature Controllers

Specifications

Model		HX9	HX2	HX7	HX3	HX4
Appearance						
W×H×D (mm)		96.0×96.0×63.0	48.0×96.0×63.0	72.0×72.0×63.0	96.0×48.0×63.0	48.0×48.0×63.0
Power voltage		100 - 240 V a.c. (±10 %), 50/60 Hz				
Power consumption		Max. 6 W, max. 10 VA				
Input (Multi Input)	Type	Refer to "Range and input code chart"				
	Sampling cycle	62.5 ms				
	Accuracy	±0.5 % of FS (refer to "range and input code chart")				
	Allowable voltage	Within ±20 V d.c. [VDC], within ±10 V d.c. [TC,RTD]				
	Reference junction compensation accuracy	±3.5 °C (0 ~ 50 °C)				
Control output	Operation after input break	Thermocouple: OFF, UP/DOWN RTD UP				
	Relay	NO: 5 A 250 V a.c., 5 A 30 V d.c. (resistive load), NC: 3 A 250 V a.c., 1 A 30 V d.c. (resistive load)				
	Voltage output (SSR)	ON voltage: min. 12 V d.c., OFF voltage: max. 0.1 V d.c. load resistance min. 600 Ω				
Retransmission output	Current output (SCR)	Range: 4 - 20 mA (±5 %), load resistance max. 600 Ω				
	Alarm output	Range: 4 - 20 mA (±5 %), load resistance max. 600 Ω, range: 0 - 20 mA (±5 %), load resistance max. 600 Ω				
Control input	Contact input	5 A 250 V a.c., 5 A 30 V d.c. (resistive load)				
	Control type	OFF resistance value: 10 kΩ min, ON resistance value: less than 1 kΩ				
Control	Output operation	ON/OFF, PID control				
	ARW (Anti-reset windup)	Direct action, reverse action				
	Standard	Auto (A=0), 0.1 ~ 100.0 %				
Interface	Maximum number of connections	RS485 standard				
	Communication method	31. Address setting 1~99 available				
	Synchronization method	2-wire half-duplex				
	Communication sequence	Asynchronous				
	Communication distance	No sequence				
	Communication speed	Within 1.2 km				
	Start bit	2400, 4800, 9600, 14400, 19200 bps selectable by setting				
	Data length	1 BIT				
	Parity bit	7 or 8 BIT				
	Stop bit	NONE, EVEN, ODD				
	Protocol	1 or 2 BIT				
Insulation resistance	Response time	PC.LINK, PC.LINK SUM, MODBUS-ASCII, MODBUS-RTU				
	Dielectric strength	Actual response time = handling time + (Response time X 25 ms)				
	Ambient temperature & humidity	Min. 20 MΩ (1st terminal - 2nd terminal)				
		2300 V a.c. for 1 min (1st terminal - 2nd terminal)				
		0 ~ 50 °C, 35 ~ 85 % RH (without condensation)				

Suffix code

Model	Code	Content
HX	□ □ □	Multi Input/Output Digital Temperature Controller
Appearance	2	48(W) × 96(H) mm
	3	96(W) × 48(H) mm
	4	48(W) × 48(H) mm
	7	72(W) × 72(H) mm
Control output	0	Normal type
	1	Heating/cooling control (simultaneous control)
HX2/3/9 specifications	0	No options (basic specifications: alarm output 2 contacts, contact input 2 contacts (SV2, SV3))
	1	RS485 communication + heater break alarm (HBA)
HX7 specifications	0	No options (basic specifications: alarm output 2 contacts)
	1	RS485 communication + DI 2 contacts (SV2, SV3)
HX4 specifications	0	RS485 communication + heater break alarm (HBA)
	1	No options (basic specifications: Alarm output 2 contacts)
	2	RS485 communication + DI 1 contact (SV2)





Range and input code chart

Classification	Code	Input	Range (°C)	Accuracy	Remarks
Thermocouple (TC)	1	K *1	-200 ~ 1370	±0.5 % of FS ±1 Digit	<ul style="list-style-type: none"> FS is from the mini to the max. value of each measurable range Digit is the minimum display value *Less than 1.0 °C: ±1.0 % of FS ±1 digit *2. 0 ~ 400 °C range: ±10 % of FS ±1 digit (C1603) *3. 20 →KPt100 Ω (IEC751) *4. When using current input, attach 250Ω 0.1% resistor to the input signal terminal
	2	K *1	-199.9 ~ 999.9		
	3	J *1	-100.0 ~ 999.9		
	4	E *1	-100.0 ~ 999.9		
	5	T *1	-199.9 ~ 400.0		
	6	R	0 ~ 1700		
	7	B *2	0 ~ 1800		
	8	S	0 ~ 1700		
	9	L *1	-100.0 ~ 900.0		
	10	N	-200 ~ 1300		
	11	U *1	-199.9 ~ 400.0		
	12	W	0 ~ 2300		
	RTD	13	Platinel II		
20		KPt100 Ω *3	-199.9 ~ 500.0	±0.5 % of FS ±1 Digit	
21		Pt100 Ω *3	-199.9 ~ 640.0		
22		Pt100 Ω *3	-200 ~ 640		
DC voltage (VDC / mV DC)	30	1.000 - 5.000 V d.c.	-1999~9999	±0.5 % of FS ±1 Digit	
	31	0.0 - 100.0 mV d.c.	(Scaling function uses (SL-H/SL-L))		
DC current	30	4 - 20 mA d.c. *4			

Temperature Controllers

AX series Multi Input Digital Temperature Controllers CE

Specifications

Model		AX9	AX2	AX7	AX3	AX4
Appearance						
W×H×D (mm)		96.0×96.0×63.0	48.0×96.0×63.0	72.0×72.0×63.0	96.0×48.0×63.0	48.0×48.0×63.0
Input type		Multi input (thermocouple : K, J, R, T, IEC 584-1, RTD : Pt100 Ω, IEC751)				
Sampling cycle		100 ms				
Input impedance		Max. 1 MΩ				
Allowable input voltage		Max. 10 V d.c.				
Accuracy		±0.3 % of FS ±1 digit (in case of R type, ±1.0 % of FS ± 1 digit in the 0 ~ 600 °C range)				
Display		7 Segment LED (PV : Red, SV : green)				
Front size (mm)	PV	22.5×11.2	14.5×7.0	14.5×7.0	15.9×7.6	13.0×6.5
	SV	18.7×9.3	10.8×5.2	9.4×4.7	12.0×6.0	9.2×5.2
Insulation Resistance		Min. 20 MΩ, 500 V d.c for 1 min (between 1st and 2nd terminal)				
Dielectric strength		2300 V a.c. 50/60 Hz for 1 min (between 1st and 2nd terminal)				
Control type		PID control (PID control by auto-tuning), ON/OFF control, P control				
Control output operation		Direct action / reverse action (selection by parameter setting)				
Control output type	Relay output (RLY 1)		1A contact, 3 A 240 V a.c. 3 A 30 V d.c. (resistive load) But the relay control output can be set as alarm output when not in use.			
	Voltage output (SSR)	Time-division proportional control (CYC)	12 - 15 V d.c. pulse voltage (load resistance min. 600 Ω)			
		Phase control (PHA)				
	Current output (SCR)		4 - 20 mA d.c. (load resistance max. 600 Ω)			
Power voltage		100 - 240 V a.c. 50/60 Hz (10 % of power voltage)				
Voltage fluctuation rate		±10% of power voltage				
Power consumption		Max. 5.5 VA				
Ambient temperature & humidity		- 5 ~ 50 °C, 35 ~ 85 % RH (without condensation)				
Weight (packed)		400 g	320 g	300 g	320 g	180 g

Suffix code





Model	Code	Content
AX	<input type="checkbox"/> - <input type="checkbox"/> <input type="checkbox"/>	Multi Input Digital Temperature Controller
Appearance	2	48(W) X 96(H) mm
	3	96(W) X 48(H) mm
	4	48(W) X 48(H) mm
	7	72(W) X 72(H) mm
	9	96(W) X 96(H) mm
Option	1	Relay 1 + Relay 2+SSR
	2	Relay 1 + Relay 2 + Relay 3 + SSR
	1B	SSR + Relay 1(form C) + Relay 2
	2B	SSR + Relay 1(form C) + Relay 2 + Relay 3
	3	4 - 20 mA + Relay 2
	4	4 - 20 mA + Relay 2 + Relay 3
Power	A	100 - 240 V a.c. 50/60 Hz

※ The relay output operates as control output, alarm output and LBA output depending on the internal parameter settings.

Temperature Controllers

■ **NX series** Multi Input / Output Digital Temperature Controllers  

Specifications

Model		NX9	NX2	NX7	NX3
Appearance					
W×H×D (mm)		96.0×96.0×100.0	48.0×96.0×100.0	72.0×72.0×100.0	96.0×48.0×100.0
Input (Multi Input)	Thermocouple input	K, J, E, T, R, B, S, L, N, U, W, PL2			
	RTD input	KPt 100 Ω, Pt 100 Ω			
	DC voltage input	1 - 5 V d.c., -10 - 20 mV, 0 - 100 mV, 4 - 20 mA (attach 250 Ω external resistor)			
	Input sampling cycle	250 ms			
	Input display resolution	Basically, below the measuring range decimal point			
	Input impedance	Thermocouple and DC voltage input (mV): min. 1 MΩ, DC voltage input (V): approx. 1 MΩ			
	Allowable signal source resistance	Thermocouple (max. 250 Ω), DC voltage (max. 2 kΩ)			
	Lead wire allowable resistance	RTD (max. 10 Ω, but the resistance among 3 lines should be same)			
	Allowable input voltage	Within ±10 V (thermocouple, RTD, DC voltage (mV)), within ±20 V (DC voltage (V))			
	Scaling	-1999 ~ 9999 (Within SL-L ~ SL-H range)			
	Input correction	-100.0 % ~ 100.0 % of FS			
	Reference contact compensation error	±1.5 °C (15 ~ 35 °C range), ±2.0 °C (0 ~ 50 °C range)			
	Input disconnection detection	OFF, UP/DOWN scale selection (thermocouple), UP scale (RTD)			
Performance	Display accuracy	±0.5 % of FS ±1 Digit, thermocouple (K, J, E, T, R, B, S, L, U, W, PL2)			
		±1.0 % of FS ±1 Digit, thermocouple (N)			
		±0.5 % of FS ±1 Digit, RTD (KPt100 Ω, Pt100 Ω), DC voltage			
	External power supply	Max. 12 V d.c., 20 mA (cannot be used when using retransmission output)			
	Insulation Resistance	Min. 20 MΩ (500 V d.c.), among 1st terminal, 2nd terminal and earth terminal			
Dielectric strength	2300 V a.c. 50/60 Hz for 1 min (among 1st terminal, 2nd terminal and earth terminal)				
	1500 V a.c. 50/60 Hz for 1 min (between 2nd terminal and FG)				
Communication (optional)	Communication method	RS422 (4-wire), RS485 (2-wire)			
	Protocol	PC Link STB, PC Link with Checksum, MODBUS (RTU), MODBUS (ASCII)			
	Communication speed	2400, 4800, 9600, 14400, 19200 BPS			
	Max. number of connections	31 (address setting 1 ~ 99)			
	Communication distance	Max. 1.2 km (total length)			
Control functions and output	Control method	PID auto-tuning			
	Control operation	a) reverse operation (heating) / forward operation (cooling) arbitrary selection (by parameter setting) b) simultaneous heating / cooling control			
	Setting Range	Refer to range and input code			
	Contact input (DI)	Select among 3 preset temperatures with external contact			
	Auto-tuning 2 types	Select target value / low target value auto-tuning			
	Proportional band	0.1 ~ 999.9 % (heating / cooling type: 0.0 to 999.9%)			
	Integral time	OFF, 1 ~ 6000 sec			
	Differential time	OFF, 1 ~ 6000 sec			
	ARW (Anti Reset Wind-up)	Auto, 50.0 ~ 200.0 % (Proportional band)			
	ON / OFF control	Select output type by parameter			
	PID selection	Zone PID / Group PID selection			
	Manual reset	Manual reset can be set when Integral time is OFF			
	Output amount at input disconnection (OUT1)	-5.0 ~ 105.0 (normal type), 0.0 ~ 105.0 % (heating / cooling type)			
Output amount at input disconnection (OUT2)	0.0 ~ 105.0 %				

Temperature Controllers

Control functions and output	Normal type Hysteresis	0.0 ~ 100.0 % of FS (but ON/OFF control)			Temperature Controllers	
	Heating/cooling hysteresis	0.0 ~ 100.0 % of FS (but ON/OFF control)				
	Heating/cooling dead band	-100.0 ~ 50.0 % (proportional band)				
	Fuzzy function	Function selection by parameter				
	Ramp function	Inclination selection of output amount to set temperature (set value (° C) / hour (min))			Recorders	
	Retransm. output type	Present value /set value /output amount /external power supply (max. 12 V d.c., 20 mA) selection			Digital Counter/ Timers	
	Retransm. output scaling	By setting range limitation or scaling setting				
	Alarm setting range	0 ~ 100 % of range (absolute alarm), ± 100 % (deviation alarm)				
	Alarm hysteresis	0 ~ 100 % of range				
	Heater break alarm	<ul style="list-style-type: none"> ● ON/OFF control, can be used on time proportional control output (cannot detect when output ON / OFF time is less than 0.2 sec) ● Measuring current: 1 - 50 A a.c. (Resolution: 0.5 A, ± 5 % of FS ± 1 Digit) (Note) When using cooling output as relay, Alarm output 1 contact reduction CT for heater break detectionType: Model name CT-50N (Ver 4.1 min)			Multi Pulse Meters	
Alarm type	21 types (setting by parameter) ※ refer to alarm type and code					
Control output	Relay output	Contact capacity: 1 C, 240 V a.c., 3 A, 30 V d.c. 3 A (resistive load) but NX1: 1A contact, 240 V a.c., 1 A, 30 V d.c. 1 A (resistive load) Time resolution: Lower between 0.1 % or 10 ms			Panel Meters	
	Voltage output (SSR)	Approx. min. 12 V d.c. (load resistance min. 600 Ω) approx. 30 mA limit during short circuit Time resolution: smaller between 0.1 % or 10 ms			Peripheral Devices	
	Current output (SCR)	4 - 20 mA d.c. (load resistance max. 600 Ω) Accuracy: ± 0.5 % of FS (4 - 20 mA d.c. range) Resolution: approx. 3000				
Alarm output	AL1, AL2, HBA common	1a 2 contacts (NX2, NX3, NX9) 240 V a.c., 1 A, 30 V d.c. 1 A (resistive load)			Proximity Sensors	
Retransmission output	Current output	0 - 20 mA, 4 - 20 mA d.c. (load resistance max. 600 Ω) Accuracy: ± 0.5 % of FS (4 - 20 mA d.c. range) Resolution: approx. 3000			Photo Sensors	
Power voltage		100 - 240 V a.c. 50/60 Hz, 24 V d.c. (±10% of power voltage)				
Power consumption		Max. 10 VA				
Ambient temperature & humidity		0 ~ 50 °C, 35 ~ 85 % RH (without condensation)				
Storage temperature		-25 ~ 65 °C				
Weight		472 g	342 g	344 g	340 g	Thyristor Power Regulators

Suffix code

Model	Code	Content	
NX	<input type="checkbox"/> - <input type="checkbox"/> <input type="checkbox"/> <input type="checkbox"/> <input type="checkbox"/>	Multi Input/Output Temperature Controller	Power Supplies
Appearance	2	48(W) X 96(H) mm	Control Switches / Combination Display Lights
	3	96(W) X 48(H) mm	
	7	72(W) X 72(H) mm	
	9	96(W) X 96(H) mm	Power / Main / Cam Switches
Control type	0	Normal type (heating control)	Limit Switches
	1	Heating / cooling control (simultaneous)	
NX9 Option	0	None (basic specifications: Alarm output 2 contacts , SV2, 3)	Micro Switches
	1	RS485, HBA	
NX7 Option	0	None (basic specifications: Alarm output 2 contacts)	Foot / Mono Lever / Pendant Switches
	1	RS485, HBA	
	2	SV2, SV3, HBA	
NX2, 3 Option	0	SV2, SV3 (basic specifications: Alarm output 2 contacts)	Signal Lights
	1	HBA	
	2	RS485	
Power voltage		100 - 240 V a.c. 50/60 Hz	Power Buzzers / Terminal Blocks Fuse Holders / Control Boxes
	D	24 V d.c.	

Temperature Controllers

■ **NX4** Multi Input/Output Digital Temperature Controllers  

Specifications

Model		NX4
Appearance		
W×H×D (mm)		48.0×48.0×100.0
Input	Thermocouple input	K, J, E, T, R, B, S, L, N, U, W, PL2
	RTD input	KPt 100 Ω, Pt 100 Ω
	DC voltage input	1 - 5 V d.c., -10 - 20 mV, 0 - 100 mV, 4 - 20 mA (attach 250 Ω external resistor)
	Input sampling cycle	250 ms
	Input display resolution	Basically, below the measuring range decimal point
	Input impedance	Thermocouple and DC voltage input (mV): min. 1 MΩ, DC voltage input (V): approx. 1 MΩ
	Allowable signal source resistance	Thermocouple (max. 250 Ω), DC voltage (max. 2 kΩ)
	Lead wire allowable resistance	RTD (max. 10 Ω, but the resistance among 3 lines should be same)
	Allowable input voltage	Within ±10 V (thermocouple, RTD, DC voltage (mV)), within ±20 V (DC voltage (V))
	Scaling	-1999 ~ 9999 (Within SL-L ~ SL-H range)
	Input correction	-100.0 % ~ 100.0 % of FS
	Reference contact compensation error	±1.5 °C (15 ~ 35 °C range), ±2.0 °C (0 ~ 50 °C range)
	Input disconnection detection	OFF, UP/DOWN scale selection (thermocouple), UP scale (RTD)
Performance	Display accuracy	±0.5 % of FS ±1 Digit, thermocouple (K, J, E, T, R, B, S, L, U, W, PL2) ±1.0 % of FS ±1 Digit, thermocouple (N) ±0.5 % of FS ±1 Digit, RTD (KPt100 Ω, Pt100 Ω), DC voltage
	External power supply	Max. 12 V d.c., 20 mA (Cannot be used when using retransmission output)
	Insulation Resistance	Min. 20 MΩ (500 V d.c.), among 1st terminal, 2nd terminal and earth terminal
	Dielectric strength	2300 V a.c. 50/60 Hz for 1 min (among 1st terminal, 2nd terminal and earth terminal) 1500 V a.c. 50/60 Hz for 1 min (between 2nd terminal and FG)
Communication (optional)	Communication method	RS485 (2-wire)
	Protocol	PC Link with Checksum, MODBUS (RTU), MODBUS (ASCII)
	Communication speed	2400, 4800, 9600, 14400, 19200 bps
	Max. number of connections	31 (address setting 1 ~ 99)
Communication distance	Max. 1.2 km (total length)	
Control functions and output	Control type	PID auto-tuning
	Control operation	a) reverse action (heating)/direct action (cooling) Random selection (by parameter setting) b) heating/cooling simultaneous control
	Setting range	Same as input range chart
	Digital input (DI)	Selects 3 set temperatures that had been previously set as an external contact
	Auto-tuning 2 types	Target value / Low target value auto-tuning selection
	Proportional band	0.1 ~ 999.9 % (heating/cooling type: 0.0 ~ 999.9 %)
	Integral time	OFF, 1 ~ 6000 sec
	Derivative time	OFF, 1 ~ 6000 sec
	ARW (Anti Reset Wind-up)	Auto, 50.0 ~ 200.0 % (Proportional band)
	ON/OFF control	Output type selection by parameter
	PID selection	Zone PID / Group PID selection
	Manual reset	The manual reset can be set when integral time is OFF
	Output amount during input disconnection (OUT1)	-5.0 ~ 105.0 (Normal type), 0.0 ~ 105.0 % (heating/cooling type)
	Output amount during input disconnection (OUT2)	0.0 ~ 105.0 %
Normal type Hysteresis	0.0 ~ 100.0 % of FS (but ON/OFF control)	

Temperature Controllers

Control functions and output	Heating/cooling type hysteresis	0.0 ~ 100.0 % of FS (but ON/OFF control)	Temperature Controllers	
	Heating/cooling dead band	-100.0 ~ 50.0 % (Proportional band)		
	Fuzzy function	Function selection by parameter		
	Ramp function	Inclination selection of output amount to set temperature (set value (° C) / hour (min))		Recorders
	Retransmission output type selection	Present value / set value / output amount / external power supply (max. 12 V d.c., 20 mA) selection		
	Retransmission output scaling	By setting range limitation or scaling setting		Digital Counter/ Timers
	Alarm setting range	0 ~ 100 % of range (absolute alarm), ±100 % (deviation alarm)		
	Alarm hysteresis	0 ~ 100 % of range		
	Heater break alarm	ON/OFF control, can be used on time proportional control output (cannot detect when output ON / OFF time is less than 0.2 sec) Measuring current: 1 - 50 A a.c. (resolution: 0.5 A, ±5 % of FS ±1 Digit) (Note) When using cooling output as relay, alarm output 1 contact decrease CT type heater break detection: CT-50N (Ver 4.1 and over)		Analog Timers
Control output	Relay output	Contact capacity: 1 C, 240 V a.c., 3 A, 30 V d.c. 3 A (resistive load), but NX1 1a contact, 240 V a.c., 1 A, 30 V d.c. 1 A (resistive load). Time resolution: smaller between 0.1 % or 10 ms	Multi Pulse Meters	
	Voltage output (SSR)	Approx. min. 12 V d.c. (load resistance min. 600 Ω) approx. 30 mA limit during short circuit Time resolution: smaller between 0.1 % or 10 ms	Panel Meters	
	Current output (SCR)	4 - 20 mA d.c. (load resistance max. 600 Ω) Accuracy: ±0.5 % of FS (4 - 20 mA range), resolution: approx. 3000	Peripheral Devices	
Alarm output	AL1, AL2, HBA (common)	1a 2 contacts, 240 V a.c., 1 A, 30 V d.c. 1 A (resistive load)	Proximity Sensors	
Retransmission output	Current output	0 - 20 mA, 4 - 20 mA d.c. (load resistance max. 600 Ω) Accuracy: ± 0.5 % of FS (4 - 20 mA range), resolution: approx. 3000	Photo Sensors	
Power voltage		100 - 240 V a.c. 50/60 Hz, 24 V d.c. (±10% of power voltage)	Rotary Encoders	
Power consumption		Max. 10 VA	Thyristor Power Regulators	
Ambient temperature & humidity		0 ~ 50 °C, 35 ~ 85 % RH (without condensation)	Solid State Relays	
Storage temperature		-25 ~ 65 °C	Power Supplies	
Weight		342 g	Control Switches / Combination Display Lights	

Suffix code

Model	Code	Content	
NX4-	<input type="checkbox"/> <input type="checkbox"/> <input type="checkbox"/>	Multi Input/Output Temperature Controller, 48(W) X 48(H) mm	
Control type	0	Normal type (heating control)	
	1	Heating / cooling control (simultaneous control)	
NX4 Option	0	None	
	1	HBA, AL2	Power Switches
	2	SV2, SV3	Control Switches / Combination Display Lights
	3	RET, RS485	
	4	RS485, SSR/SCR (cooling control output). The Normal type only has communication function	Power / Main / Cam Switches
	5	AL1, AL2	
	6	AL1, AL2, SV2	Limit Switches
Power voltage		100 - 240 V a.c. 50/60 Hz	
	D	24 V d.c.	

(note 1) Option 1 : OUT1 (terminal ①-②-③) is applied as AL1 But, only with control output SSR/SCR selection

Option 3 : OUT2 (terminal ⑩-⑪) is applied as RET

Option 4 : OUT2 (terminal ⑩-⑪) is applied as SSR / SCR

Option 5 : OUT1 (terminal ⑥-⑦) is impossible to apply as SV2

Option 6 : OUT1 (terminal ⑥-⑦) is applied as SV2 but only with relay control output

Temperature Controllers

NX1 Multi Input/Output Digital Temperature Controllers (PID auto-tuning)

Specifications

Model		NX1
Appearance		
W×H×D (mm)		48.0×24.0×100.0
Input	Thermocouple input	K, J, E, T, R, B, S, L, N, U, W, PL2
	RTD input	KPt 100 Ω, Pt 100 Ω
	DC voltage input	1 - 5 V d.c., -10 - 20 mV, 0 - 100 mV, 4 - 20 mA (attach 250 Ω external resistor)
	Input sampling cycle	250 ms
	Input display resolution	By default, below the decimal point of the range
	Input impedance	Min. 1 MΩ (thermocouple, DC voltage input)
	Allowable signal source resistance	Max. 250 Ω (thermocouple input), max. 2 kΩ (DC voltage input)
	Lead wire allowable resistance	Max. 10 Ω (RTD input)
	Allowable input voltage	±10 V (thermocouple, RTD, DC voltage: mV), ±20 V (DC voltage: V)
	Scaling	-1999 ~ 9999 (but SL-H > SL-L)
	Reference contact compensation error	±1.5 °C (15 ~ 35 °C), ±2.0 °C (0 ~ 50 °C)
Input disconnection detection	UP Scale/DOWN Scale selection (thermocouple input), UP Scale (RTD input)	
Performance	Display accuracy	● ±0.5 % of FS ±1 Digit. thermocouple (K, J, E, T, L, U, W, PL2) ● ±1.0 % of FS ±1 Digit thermocouple (N) ● ±0.5 % of FS ±1 Digit. RTD (KPt100 Ω, Pt100 Ω), DC voltage
	External power supply	Max. 12 V d.c. 20 mA (Cannot be used when using retransmission output)
	Insulation Resistance	Min. 20 MΩ (500 V d.c.) among 1st terminal - 2nd terminal - Earth terminal
	Dielectric strength	2300 V a.c. 50/60 Hz for 1 min (among 1st terminal - 2nd terminal - Earth terminal), 1500 V a.c. 50/60 Hz, for 1 min (2nd terminal - FG)
Control functions and output	Control type	PID auto-tuning
	Control operation	a) Reverse action (heating)/direct action (cooling) random selection (by parameter setting) b) Heating/cooling simultaneous control
	Setting range	Same as input range chart
	Digital input (DI)	Selects 3 set temperatures that had been previously set as an external contact
	Auto-tuning 2 types	Target value / Low target value auto-tuning selection
	Proportional band	0.1 ~ 999.9 % (heating/cooling type: 0.0 ~ 999.9 %)
	Integral time	OFF, 1 ~ 6000 sec
	Derivative time	OFF, 1 ~ 6000 sec
	ARW (Anti Reset Windup)	Auto, 50.0 ~ 200.0 % (proportional band)
	ON/OFF control	Output type selection by parameter
	PID selection	Zone PID / group PID selection
	Manual reset	The manual reset can be set when integral time is OFF
	Output at input disconnection	Set the amount of output during input disconnection
	Normal type hysteresis	0.0 ~ 100.0 % of FS (ON/OFF control output, Alarm output, heater break alarm output)
	Heating/cooling hysteresis	0.0 ~ 100.0 % of FS (ON/OFF control output)
Heating/cooling type dead band setting	-100.0 ~ 50.0 % (Proportional band)	
Power voltage	100 - 240 V a.c. 50/60 Hz, 24 V d.c.	
Voltage fluctuation rate	±10 % of power voltage	
Power consumption	Max. 8 VA	
Ambient temperature & humidity	0 ~ 50 °C, 35 ~ 85 % RH (without condensation)	
Storage temperature	-25 ~ 65 °C	
Weight	94 g	

Suffix code

Model	Code	Content		
NX1-	<input type="checkbox"/> <input type="checkbox"/> <input type="checkbox"/>	Multi Input/Output Temperature Controller		
Control type	0	Normal type		
	1	Heating / cooling control (simultaneous)		
Normal type option		Option	Heat. output	Cool. output
	0	RET	Relay	-
	1	None	SSR/SCR	-
	2	RS485/RET	Relay	-
	3	RS485	SSR/SCR	-
	4	ALM	SSR/SCR	-
Heating/cooling type option	0	None	Relay	SSR/SCR
	1	None	SSR/SCR	Relay
	2	RS485	Relay	SSR/SCR
Power voltage		100 - 240 V a.c. 50/60 Hz		
	D	24 V d.c.		

Range and input code chart

Classification	Code	Input	Range (°C)	Accuracy	Remarks
Thermocouple (TC)	1	K *1	-200 ~ 1370	±0.5 % of FS ±1 Digit	· FS is from the mini to the max. value of each measurable range · Digit is the minimum display value *1. Less than 1.0 °C: ±1.0 % of FS ±1 digit *2. 0 ~ 400 °C range: ±10 % of FS ±1 digit *3. 20 → KPt100 Ω (C1603) 21, 22 → Pt100 Ω (IEC751) *4. When using current input, attach 250 Ω 0.1% resistor to the input signal terminal
	2	K *1	-199.9 ~ 999.9		
	3	J *1	-100.0 ~ 999.9		
	4	E *1	-100.0 ~ 999.9		
	5	T *1	-199.9 ~ 400.0		
	6	R	0 ~ 1700		
	7	B *2	0 ~ 1800		
	8	S	0 ~ 1700		
	9	L *1	-100.0 ~ 900.0		
	10	N	-200 ~ 1300		
	11	U *1	-199.9 ~ 400.0		
	12	W	0 ~ 2300		
	RTD	13	Platinel II		
20		KPt100 Ω *3	-199.9 ~ 500.0		
21		Pt100 Ω *3	-199.9 ~ 640.0		
22		Pt100 Ω *3	-200 ~ 640		
DC voltage (VDC / mV DC)	30	1.000 - 5.000 V d.c.	-1999-9999	±0.5 % of FS ±1 Digit	
	31	0.0 - 100.0 mV d.c.	(Scaling function uses (SL-H/SL-L))		
DC current	30	4 - 20 mA d.c. *4			

(note 1) NX1-1 can select 6, 9, 10, 11 control output

Temperature Controllers

■ BX8 Board Type Temperature Controllers

■ Specifications

Model		BX8	
Appearance			
Power voltage		100 - 240 V a.c. (Voltage fluctuation rate: ±10 %)	
Input	Input	<ul style="list-style-type: none"> ● Thermocouple: K, J, E, T, R, B, S, L, N, U, WRe 5-26, PL- II (refer to input signal and measuring range) ● RTD : Pt100 Ω, KPt100 Ω ● DC voltage input: 1 - 5 V, -10 - 20 mV, 0 - 100 mV (freescala) 	
	Sampling cycle	250 ms	
	Input impedance	Thermocouple and DC voltage input (mV): min. 1 MΩ, DC voltage input (V): approx. 1 MΩ	
	Allowable signal source resistance	Thermocouple: max. 250 Ω, voltage: max. 2 kΩ	
	Lead wire allowable resistance	RTD : max. 10 Ω/1 wire (but the conductor resistance among 3 wires should be same)	
	Allowable input voltage	Within ±10 V (thermocouple, RTD, voltage: mV d.c.), within ±20 V (voltage: V d.c.)	
	Noise removal rate	NMRR (normal mode): 40 dB min (50/60 Hz ±1 %), CMRR (common mode): 120 dB min (50/60 Hz ±1 %)	
	Standard	Thermocouple/RTD (KS/IEC 751/DIN)	
	Reference contact compensation error	±1.5 °C (15 ~ 35 °C interval), ±2.0 °C (0 ~ 50 °C interval)	
	Input disconnection detection (BURN-OUT)	Thermocouple: OFF, UP/DOWN Scale selection, RTD : UP Scale (thermocouple and RTD BURN-OUT) detection current: approx. 50 nA	
	Measuring accuracy	±0.5 % (FULL SCALE)	
Output	Retransmission output		<ul style="list-style-type: none"> ● Current output range: 4 - 20 mA d.c. ● Load resistance: max. 600 Ω ● Resolution: approx. 3000 ● Output refresh interval: 250 ms ● Accuracy: ±0.5% of max. scale (4 - 20 mA range) ● Output ripple: ±0.3% of max. scale (P-P) max. (150 Hz)
	Alarm output (HBA)		<ul style="list-style-type: none"> ● Contact capacity: 240 V a.c. 1 A, 30 V d.c. 1 A (resistive load) ● Contact configuration: 1 a ● Output points: Depending on model specifications (refer to connection diagram) ● Number of contacts: 1 contact · Current measuring range: 1 - 50 A a.c. (resolution: 0.5 A, ±5 % of max. scale ±1 digit) ● Alarm output: selectable in alarm output ● Dead band: 0 ~ 100 % of max. range ● Other: available during ON/OFF control or time proportional output (but not during current output or cooling output) ● Break detection is not possible below 0.2 sec. during output on
	Control output	Relay contact output	<ul style="list-style-type: none"> ● Contact capacity: 240 V a.c. 3 A, 30 V d.c. 3 A (resistive load) ● Contact configuration: 1 C ● Time resolution: smaller between 0.1 % or 10 ms · Proportional period: 1 ~ 1000 s ● Output operation: time proportional, ON/OFF ● Output limit: 0.0 ~ 100.0 % range high limit (OH), low limit(OL) selectable (also during auto-tuning) ● ON / OFF hysteresis: 0 ~ 100 % (Full Scale)
		SSR output (Voltage pulse output)	<ul style="list-style-type: none"> ● ON voltage: min. approx. 24 V d.c. (load resistance min. 600 Ω, 30 mA current limit during short circuit) ● Proportional period: 1 ~ 1000 s ● OFF voltage: max. 0.1 V d.c. ● Output operation: time proportional ● Time resolution: smaller between 0.1 % or 10 ms ● Output limit: 0.0~100.0 % range, high limit (OH) low limit(OL) selectable (also during AT)
		Current output (4 - 20 mA)	<ul style="list-style-type: none"> ● Current output range: 4 - 20 mA d.c. ● Load resistance: max. 600 Ω ● Output refresh interval: 250 ms ● Output operation: continuous PID ● Accuracy: ±0.5% of max. scale (4 - 20 mA range) ● Resolution: approx. 3000 ● Output ripple: ±0.3% of max. scale (P-P) max. (150 Hz) ● Output limit: -5.0 ~ 105.0 % range, high limit (OH) low limit(OL) selectable (also during AT)
	Weight		Approx. 300 g

※ Control output: output can be selected from relay, current or SSR, heating / cooling type can be set individually.







■ Suffix code

Model	Code	Content
BX8-	<input type="checkbox"/> <input type="checkbox"/>	Board Type Digital Temperature Controller
Control type	0	Normal right
	1	Heating/cooling type
Option	0	SV2 / SV3 (basic specifications: alarm output 2 contacts , (1 contact is determined by cooling output))
	1	HBA
	2	RS485
	3	HBA / RS485

Temperature Controllers

■ KX series Multi Input Digital Temperature Controllers (PID auto-tuning) CE

Specifications

Model		KX9N	KX2N	KX7N	KX3N	KX4N	KX4S
Appearance							
W×H×D (mm)		96.0×96.0×100.0	48.0×96.0×100.0	72.0×72.0×100.0	96.0×48.0×100.0	48.0×48.0×100.0	48.0×48.0×87.0
Input	Thermocouple input	K, J, E, T, R, B, S, L, N, U, W, PL2					
	RTD input	Pt 100 Ω, KPt 100 Ω					
	DC voltage input	1 - 5 V d.c. (4 - 20 mA d.c.), 0 - 10 V d.c.					
	Input display resolution	Basically, below the range decimal point					
	Input sampling cycle	250 ms					
	Allowable signal source resistance	Max. 250 Ω (Thermocouple input), max. 2 kΩ (DC voltage input)					
	Lead wire allowable resistance	RTD: max. 10 Ω/1 wire. The resistance between 3 lines should be same					
	Allowable input voltage	±20 V d.c. for 1 min					
	Scaling	0.0 % ~ 100.0 % of FS					
	Reference contact compensation error	±3.5 °C (0 ~ 50 °C range)					
Input disconnection function	Up-scale and output OFF when input is disconnected						
Performance	Display accuracy	± 0.5 % of FS (but, 0 ~ 400 °C range of B thermocouple is out of guarantee range). Refer to "range and input code chart"					
	Insulation Resistance	Min. 20 MΩ, 500 V d.c., for 1 min (between 1st and 2nd terminal)					
	Dielectric strength	2300 V a.c. 50/60 Hz for 1 min (between 1st and 2nd terminal)					
Control functions and output	Setting range	Refer to "Range and input code chart"					
	Control type	PID control, ON/OFF control					
	Proportional band (P)	Within input range					
	Integral time	0 ~ 3,600 sec.					
	Derivative time	0 ~ 3,600 sec.					
	ARW (Anti Reset Wind-up)	Within input range					
	Control loop break alarm (LBA)	0 ~ 7,200 sec					
	Proportional period	0 ~ 100 sec.					
	Control output hysteresis	0 ~ 10 % of FS					
	ON/OFF control	Set the Proportional band to "0" (0.0)					
	Alarm type	Absolute alarm, deviation alarm (high alarm, low alarm, within range alarm)					
	Range over display	When exceed max. range "0000", when exceed min range "UUUU" flashing					
	Decimal point function	Decimal point position selection by parameter during DC voltage input					
	Decimal point position selection	Decimal point selection during current input and DC voltage (0~3 position)					
	Input correction value setting	-100.0 ~ 100.0 of FS					
	High or low alarm hysteresis	0 ~ 10 % of FS					
High / Low range Limit	Within input range						
Output operation	Direct / reverse action selectable by setting						
Scale setting	-199 ~ 9999 (high and low scale setting during DC voltage input)						
Control output	Relay output	NO: 5 A 250 V a.c., 5 A 30 V d.c. (resistive load), NC: 3 A 250 V a.c., 1 A 30 V d.c. (resistive load)					
	Voltage output (SSR)	Min. 12 V d.c., pulse voltage (load resistance min. 600 Ω)					
	Current output (SCR)	4 - 20 mA d.c. (load resistance max. 600 Ω), Accuracy: ±0.2 mA					
Alarm output	Relay output	250 V a.c. 3 A (load resistance) ※ refer to connection diagram(contact), but KX4N: 1A contact, 250 V a.c. 1 A (load resistance)					
Retransm. output	Current output	4 - 20 mA d.c. (load resistance max. 600 Ω), Accuracy: ±0.2 mA					
Power voltage		100 - 240 V a.c. 50/60 Hz, 24 V d.c. (KX4S excluded)					
Voltage fluctuation rate		±10 % of power voltage					
Power consumption		Max. 11 VA				Max. 7 VA	
Ambient temperature & humidity		0 ~ 50 °C, 35 ~ 85 % RH (without condensation)					
Weight (packed)		Approx. 400 g	Approx. 320 g	Approx. 300 g	Approx. 320 g	Approx. 180 g	

Temperature Controllers

Suffix code

Model	Code	Content	
KX	□- □ □ □ □	Digital Temperature Controller (Multi Input)	
Dimensions	2N	48(W) X 96(H) mm	
	3N	96(W) X 48(H) mm	
	4N	48(W) X 48(H) mm	
	7N	72(W) X 72(H) mm	
	9N	96(W) X 96(H) mm	
	4S	48(W) X 48(H) mm	For 11 pin sockets (2-stage step function by external contact)
Control output	M	Relay	
	S	SSR (voltage pulse 12 V d.c.)	
	C	SCR (current 4 - 20 mA d.c.)	
Alarm output	C	※ KX4N, KX4S only	ALH, ALL, LBA (1a common output)
	E	※ KX4S not selectable	
		KX2N, KX3N, KX9N	ALH(1c),ALL (1a)
		KX7N, KX4N (optional)	ALH(1a),ALL (1a)
	K	※ KX4N, KX4S not selectable	
		KX2N, KX3N, KX9N (optional)	ALH(1c),ALL (1a),LBA (1a)
KX7N (optional)		ALH(1a),ALL (1a),LBA (1a)	
Retransmission output (optional)	A	※ Selectable only in the following models KX4N-□C KX2N-□E, KX3N-□E, KX9N-□E KX2N-□K, KX3N-□K, KX9N-□K	Retransmission output (RET) 4 - 20 mA d.c.
	N	None	
Power voltage	A	100 - 240 V a.c. 50/60 Hz	
	D	24 V d.c. (but KX4S excluded)	

※ When using 4 - 20 mA input, please attach 250 Ω 0.1% resistor to 1 - 5 V d.c input terminal

Temperature Controllers
Recorders
Digital Counter/ Timers
Analog Timers
Multi Pulse Meters
Panel Meters
Peripheral Devices
Proximity Sensors
Photo Sensors
Rotary Encoders
Thyristor Power Regulators
Solid State Relays
Power Supplies
Control Switches / Combination Display Lights
Power / Main / Cam Switches
Limit Switches
Micro Switches
Foot / Mono Lever / Pendant Switches
Signal Lights
Power Buzzers / Terminal Blocks Fuse Holders / Control Boxes

Temperature Controllers

■ MT100 Multi Input Mold Temperature Controllers

■ Specifications

Model		MT100
Appearance		
W×H×D (mm)		155.0×130.0×16.5
Input	Display screen	MONO LCD (128 X 64 mm)
	Temperature input (Multi Input)	4 contacts, thermocouple (K,J), RTD (Pt 100 Ω)
	Sampling cycle	1 sec.
	Measuring range	0 ~ 300 °C
	Input correction	±100 % of FS
	Input impedance	Approx. 1 MΩ (thermocouple input)
	Reference contact compensation error	± 1.5 °C (0 ~ 50 °C range)
	Allowable input lead resistance	RTD (max. 10 Ω, but the resistance among 3 lines should be same)
	Input disconnection detection	UP SCALE (reverse action), DOWN SCALE (direct action)
	Pressure input	1 contact (4 - 20 mA d.c. or contact input)
	Pressure sampling cycle	1 sec.
	Pressure scale range	0.00 ~ 10.00 (decimal point fixed)
	Performance	Contact input
Display accuracy		Temperature: ±0.3 % of FS ±1 Digit, pressure: ±3 % of FS ±1 Digit
Insulation Resistance		Min. 20 MΩ (500 V d.c.) measuring terminal-power terminal
Dielectric strength		2300 V a.c., 50/60 Hz for 1 min (between measuring terminal and power terminal, between power terminal and ground terminal)
Control functions and output	Digital input (DI)	8 contacts (① Option, ② Over pressure, ③ Overheating, ④ Over pump direct action, ⑤ Over pump reverse action, ⑥ Medium supplement termination, ⑦ Medium supplement start, ⑧ RUN/RESET)
	Current detection input	3 phases (3 CT)
	contact output (DO)	6 contacts (① Option, ② Temperature alarms, ③ Inhale, ④ Ramp direct action, ⑤ Ramp reverse action, ⑥ Medium supplement)
	Control output	Cooling control output (relay) 1 contact, heating control output (SSR) 1 contact
	Reverse phase detection	3-phase motor reverse rotation detection function
	Operation reservation	Reserve run time (time or weekly reservation)
	Forced cooling	When requiring sudden cooling, 100% cooling output after stopping heating output
	Preheating function	Control by preheating set value to prevent winter frost
	Abnormal history monitoring	Up to 20 errors can be memorized and displayed
	Control type	PID auto-tuning
	Proportional band	0 (0.0) to the maximum value of range
	Integral time	1 ~ 3,600 sec
	Derivative time	1 ~ 3,600 sec
	ARW (Anti Reset Wind-up)	Auto, 0 ~ 100 % (proportional band)
	ON/OFF control	Set the proportional band to "0"
	Alarm type	6 external alarms by contact input
	Communication function	RS485/422
	Control output	Cooling (relay)
Heating (SSR)		Voltage pulse: approx. min. 12 V d.c. (load resistance min. 600 Ω), Proportional period: 1 ~ 1000 sec, Time resolution: bigger between 0.1 % or 16.667 ms
Contact output 6 contacts (DO)		1 a, 250 V a.c., 1 A, 30 V d.c. 1 A (resistive load)
Communication specifications	Communication method	2-wire half-duplex or 4-wire half-duplex
	Max. number of connections	31
	Communication distance	1,200 m
	Communication sequence	No sequence
	Communication speed	9,600 bps
	Start bit	1 bit
	Stop bit	1 bit
	Data length	8 bit
Parity bit	NONE	
Protocol	PC-LINK with SUM	
Power voltage	100 - 240 V a.c., 50/60 Hz	
Voltage fluctuation rate	±10 % of power voltage	
Power consumption	8 VA	
Ambient temperature & humidity	0 ~ 50 °C, 35 ~ 85 % RH (without condensation)	
Storage temperature	-25 ~ 65 °C	
Weight	Approx. 850 g	

Temperature Controllers

Suffix code

Model	Code			Content
MT100	<input type="checkbox"/>	<input type="checkbox"/>	<input type="checkbox"/>	Multi Input Mold Temperature Controller
Communication	0			No communication
	1			RS485/422
Pressure inspection	0			No pressure inspection
	1			Pressure inspection by contact input
	2			Pressure inspection by 4 - 20mA d.c.
Current inspection (HB)	0			HB None
	1			HB 3 contacts ※CT(CTL-6-S) sold separately

Temperature
Controllers

Recorders

Digital
Counter/
Timers

Analog
Timers

Multi Pulse
Meters

Panel
Meters

Peripheral
Devices

Proximity
Sensors

Photo
Sensors

Rotary
Encoders

Thyristor
Power
Regulators

Solid
State
Relays

Power
Supplies

Control Switches /
Combination
Display Lights

Power / Main /
Cam Switches

Limit
Switches

Micro
Switches

Foot /
Mono Lever /
Pendant Switches





Signal Lights

Power Buzzers /
Terminal Blocks
Fuse Holders /
Control Boxes

Temperature Controllers

■ DX series Simple Operation, Approved Performance (PID auto-tuning)

■ Specifications

Model		DX9	DX2	DX7	DX3	DX4
Appearance						
W×H×D (mm)		96.0×96.0×100.0	48.0×96.0×100.0	72.0×72.0×100.0	96.0×48.0×100.0	48.0×48.0×100.0
Input	Thermocouple input	K, J, R				
	RTD input	KPt 100 Ω, Pt 100 Ω				
	DC voltage input	1 - 5 V d.c., 0 - 10 V d.c., 4 - 20 mA d.c.				
	Input sampling cycle	250 ms				
	Input display resolution	Basically 1 °C max. (0.1 °C max. on decimal point range)				
	Input impedance	Thermocouple and DC voltage input (mV): min. 1 MΩ. DC voltage input (V): approx. 1 MΩ				
	Allowable signal source resistance	Thermocouple max. 250 Ω, DC voltage max. 2 kΩ				
	Lead wire allowable resistance	RTD max. 10 Ω. (but the resistance among 3 lines should be same)				
	Allowable input voltage	±20 V d.c. for 1 min				
	Input correction	±100 % of FS				
	Input scaling	-1999 ~ 9999 (Within SL12 ~ SL13 range, with voltage/current input)				
Reference contact compensation error	±3.5 °C (0 ~ 50 °C range)					
Input disconnection detection	UP Scale					
Performance	Display accuracy	±0.5 % of FS (but ±1 % of FS with voltage input)				
	Retransm. output accuracy	±0.2 mA d.c. (load resistance max. 600 Ω, output range 3.2 ~ 20.8 mA d.c.)				
	Insulation voltage	Min. 20 MΩ (500 V d.c.) between input terminal and power terminal, between power terminal and protective earth terminal (enclosure)				
	Dielectric strength	2300 V a.c. 50/60 Hz for 1 min (between input terminal and power terminal, between power terminal and protective earth terminal)				
Control functions and output	Control type	PID auto-tuning				
	Control operation	Reverse action (heating) or direct action (cooling), by internal setting (SL9)				
	Setting range	Same as input range chart				
	Proportional band	0 ~ 100 % of FS				
	Integral time	0 ~ 3,600 sec				
	Derivative time	0 ~ 3,600 sec				
	ARW (Anti Reset Wind-up)	Auto (A=0), 0 ~ 100 % of FS				
	ON/OFF control	Setting Proportional band to "0" turns ON/OFF control				
	During ON/OFF control hysteresis	0~10 % of FS				
	Control loop break alarm (LBA)	1 ~ 7,200 sec (Generally, 2 times the integral time)				
	Proportional period	1 ~ 100 sec.				
	Decimal point position	1 ~ 4 (when setting "2": 000.0)				
	Retransmission output	4 - 20 mA d.c. (measured value)				
	Alarm type	High alarm(ALH), low alarm(ALL), high/low within range alarm (deviation setting, absolute setting)				
	Alarm setting range	0 ~ 100 % of FS				
High alarm (ALH) hysteresis set	0 ~ 10 % of FS					
Output	Relay output	Contact capacity: 1c, 250 V a.c. 5 A (resistive load)				
	Voltage output (SSR)	Approx. min. 12 V d.c. (load resistance min. 600 Ω)				
	Current	4 - 20 mA d.c. (load resistance max. 600 Ω). Accuracy: ±0.2 mA				
	Temperature alarm (Relay)	● DX4Alarm output (ALM): high, low alarm, LBA common, 1 a X 1 contact ● High alarm (ALH): 1 C X 1 contact (but DX7: 1 a X 1 contact)				
	LBA (Relay)	● Low alarm (ALL): 1 a X 1 contact 250 V a.c. 5A (resistive load)				
Current output	4 - 20 mA d.c. (load resistance max. 600 Ω), accuracy: ±0.2 mA.					
Power voltage	100 - 240 V a.c. 50/60 Hz, 24 V d.c. (selection by Suffix code)					
Voltage fluctuation rate	±10 % of power voltage					
Power consumption	12 VA (100 - 240 V a.c., 24 V a.c.), 4.5 W (24 V d.c.)					
Ambient temperature & humidity	0 ~ 50 °C, 35 ~ 85 % RH (without condensation)					
Storage temperature	-25 ~ 65 °C					
Vibration resistance	10 - 55 Hz, 0.76 mm, X, Y, Z each direction 2 hours					
Shock resistance	300 m/s ² 6 directions each 3 times					
Weight	Approx. 472 g	Approx. 342 g	Approx. 344 g	Approx. 340 g	Approx. 342 g	

Temperature Controllers

Suffix code

Model	Code						Content	
DX	<input type="checkbox"/>	<input type="checkbox"/>	<input type="checkbox"/>	<input type="checkbox"/>	<input type="checkbox"/>	<input type="checkbox"/>	Digital Temperature Controller	
Appearance	2						48(W) x 96(H) mm	Temperature Controllers
	3						96(W) x 48(H) mm	
	4						48(W) x 48(H) mm	
	7						72(W) X 72(H) mm	Recorders
	9						96(W) X 96(H) mm	
Input		K					K thermocouple	Digital Counter/ Timers
		J					J thermocouple	
		R					R thermocouple	Analog Timers
		D					RTD (KPt 100 Ω)	
		P					RTD (Pt 100 Ω)	
		V					1 - 5 V d.c.	Multi Pulse Meters
		C					4 - 20 mA d.c.	
Control output		M					Relay contact output	Panel Meters
		C					Current output (4 - 20 mA d.c.)	
		S					SSR (voltage pulse output, 12 V d.c.)	Peripheral Devices
Alarm output		S					Alarm output 1 contact (Model : DX4)	
		W					Alarm output 2 contacts (all models except DX4)	Proximity Sensors
Option		A					Retransmission output (4 - 20 mA d.c. measured value)	
		N					None (DX4, DX7 No retransmission output)	Photo Sensors
Control operation ※ Selection by SL9 (initial value: R)		R					Reverse action (heating control)	
		D					Direct action (except cooling)	
Power voltage							No display (100 - 240 V a.c.)	Rotary Encoders
		C					24 V a.c. / d.c.	Thyristor Power Regulators





Range and input code chart

Classification	Code	Input		Range (°C)		Accuracy	
Thermocouple (TC)	0001	K	K	-50 ~ 1,300	-50.0 ~ 999.9	±0.5 % of FS	Solid State Relays
	0101	J	J	-50 ~ 600	-50.0 ~ 600.0		
	0100	R	R	0 ~ 1700	0.0 ~ 999.9		Power Supplies
RTD (RTD)	0010	D	Kpt100 Ω	-199 ~ 500	-199.0 ~ 500.0	Decimal point by SL4	Control Switches / Combination Display Lights
	0011	P	Pt100 Ω	-199 ~ 640	-199.0 ~ 640.0		
Voltage/Current	0000	V	1 - 5 V d.c.	-1999 ~ 9999	1 % of FS		Power / Main / Cam Switches
	0000	C	4 - 20 mA d.c.	-1999 ~ 9999			
	1111	F	0 - 10 V d.c.	-1999 ~ 9999			

Temperature Controllers

■ HY series Economical Digital Temperature Controllers

■ Specifications

Model	HY-8000S	HY-8200S	HY-72D	HY-48D
Appearance				
W×H×D (mm)	96.0×96.0×125.0	96.0×96.0×125.0	72.0×72.0×110.0	48.0×48.0×100.0
Input	Thermocouple input	K, J, R		
	RTD input	Pt 100 Ω, KPt 100 Ω		
	DC voltage input	1 - 5 V d.c., 4 - 20 mA d.c.		
	Input sampling cycle	500 ms		
	Input display resolution	1 °C		
	Allowable signal source resistance	Thermocouple max. 100 Ω		
Performance	Lead wire allowable resistance	RTD (max. 10 Ω. but the resistance among 3 lines should be same)		
	Display accuracy	±1 % of FS ±1 Digit		
Control functions and output	Dielectric strength	2000 V a.c. 50/60 Hz for 1 min (among different live parts)		
	Control type	Proportional control, ON/OFF control (by suffix code)		
	Control operation	Reverse action or direct action (by suffix code)		
	Setting range	Same as input range		
	Proportional band	0.1 ~ 10.0 % of FS		
	Manual reset (MR)	±50 % of mV (output amount)		
	Proportional period	Output amount -50 ~ +50%		
	Hysteresis	0.2 % fixed (During ON/OFF control)		
	Input disconnection detection	The output is OFF when the range is over 10 °C		
	Alarm type	HY-8200S model only, high absolute alarm		
Control output	Relay output	Contact capacity: 1 C, 250 V a.c., 5 A (resistive load)		
	Voltage output (SSR)	Approx. min. 12 V d.c. (load resistance min. 800 Ω)		
	Current output	4 - 20 mA d.c. (load resistance max. 600 Ω)		
Alarm output	Relay output	Contact capacity: 1 c, 250 V a.c., 5 A (resistive load) ※ HY-8200S model only		
Power voltage	110/220 V a.c. 50/60 Hz. HY-48D model is 110/220 V by internal switch.			
Voltage fluctuation rate	±10% of power voltage			
Power consumption	Max. 3 VA			
Ambient temperature & humidity	0 ~ 50 °C, 35 ~ 85 % RH (without condensation)			
Storage temperature	-25 ~ 65 °C			
Weight	700 g	750 g	500 g	450 g

■ Suffix code

Model	Code	Content
HY-	□- □ □ □ □ □ □ □	Economical Digital Temperature Controller
Appearance	8000S	96(W) X 96(H) mm
	8200S	96(W) X 96(H) mm (high alarm standard)
	72D	72(W) X 72(H) mm
	48D	48(W) X 48(H) mm
Control type	F	ON/OFF control
	P	Proportional control
Input	K	K thermocouple
	J	J thermocouple
	R	R thermocouple
	D	RTD KPt 100 Ω
	P	RTD Pt 100 Ω (IEC 751)
	V	1 - 5 V d.c.
	C	4 - 20 mA d.c.
Control output	M	Relay output
	C	Current output (4 - 20 mA d.c.)
	S	SSR (voltage pulse output, 12 V d.c.)
Alarm output	N	None
	O	High alarm (HY-8200S)
Control operation (internal selection)	R	Reverse action (heating control)
	D	Direct action (except cooling)
Range Code		Refer to "Range and input code chart"



■ Range and input code chart

Classif.	Code	HY-8000S, 8200S		HY-72D		HY-48D				
		Input	Range (°C)	Input	Range (°C)	Input	Range (°C)			
Thermo-couple	4	-	-	-	-	K, J	0 ~ 299			
	5	-	-	-	-		0 ~ 399			
	6	K, J	0 ~ 199	K, J	0 ~ 199	-	-			
	7		0 ~ 299		0 ~ 299					
	8		0 ~ 399		0 ~ 399					
	9	-	0 ~ 599							
	10	-	0 ~ 599	0 ~ 799						
	11	-	0 ~ 799	-						
	12	K	-	K	0 ~ 1199					
	13		0 ~ 1199		R			600 ~ 1699		
	14	R	600 ~ 1699	-	-					
	RTD	1	-	-	-			-	Pt100 Ω	-49 ~ 49
		2	-	-99 ~ 99	-			-99 ~ 99		-99 ~ 99
		3	-	-99 ~ 199	-			-99 ~ 199		0 ~ 199
4		-	0 ~ 99	-	0 ~ 99			0 ~ 299		
5		Pt100 Ω	-	Pt100 Ω	-			0 ~ 399		
6		-	0 ~ 199	-	0 ~ 199	-				
7		-	0 ~ 299	-	0 ~ 299	-				
8		-	0 ~ 399	-	0 ~ 399	-				
Voltage/Current (DC)	-	1 - 5 V	0 ~ 99	1 - 5 V	0 ~ 99	1 - 5 V	0 ~ 99			
	-	4 - 20 mA	0 ~ 99	4 - 20 mA	0 ~ 99	4 - 20 mA	0 ~ 99			

Temperature Controllers

DF series Economical Digital Temperature Controllers

Specifications

Model		DF2	DF2(SUB)	DF4 (8-pin type)
Appearance				
W×H×D (mm)		48.0×96.0×100.0	48.0×96.0×100.0	48.0×48.0×86.0
Input	Thermocouple input	K, J		
	RTD input	KPt100 Ω, Pt100 Ω		
	DC voltage input	1 - 5 V d.c., 4 - 20 mA d.c.		
	Input sampling cycle	500 ms		
	Input display resolution	1 °C		
	Allowable signal source resistance	Thermocouple max. 100 Ω		
Performance	Lead wire allowable resistance	RTD (max. 10 Ω. but the resistance among 3 lines should be same)		
	Display accuracy	±1 % of FS ±1 Digit		
Control functions and output	Control type	Proportional control, ON/OFF control (by suffix code)		
	Control operation	Reverse action or direct action (by suffix code)		
	Setting range	Same as range and input code		
	Proportional band	3 % of FS	1 ~ 10 % of FS	
	Manual reset (MR)	-50 ~ +50 % (output amount)		
	Proportional period	Approx. 20 sec (relay output), approx. 2 sec (voltage output (SSR))		
	Hysteresis	0.2 % fixed (During ON/OFF control)		
	Input disconnection detection	The output is OFF when the range is over 10 °C		
	Sub output (SUB)	By suffix code (DF2 model only)		
	Sub output setting range	Within range		
Control output	Sub output hysteresis	1 °C fixed		
	Relay output	Contact capacity: 1 C, 250 V a.c. 3 A (resistive load)		
	Voltage output (SSR)	Approx. min. 12 V d.c. (load resistance min. 800 Ω)		
Alarm output	Current output (SCR)	4 - 20 mA d.c. (load resistance max. 600 Ω)		
	Relay output	Contact capacity: 1 C, 250 V a.c. 3 A (resistive load)		
Power voltage		110/220 V a.c. 50/60 Hz		
Voltage fluctuation rate		±10 % of power voltage		
Power consumption		Max. 3 VA		
Ambient temperature & humidity		0 ~ 50 °C, 35 - 85 % RH (without condensation)		
Storage temperature		-25 ~ 65 °C		
Weight		Approx. 450 g		Approx. 200 g

※ DF4 Power voltage can be 110 V or 220 V, depending on the specifications

Suffix code

Model	Code	Content
DF	□- □ □ □ □ □ □	Economical Digital Temperature Controller
Appearance	2	48(W) X 96(H) mm
	4	48(W) X 48(H) mm (socket type, 8-pin)
Control type	F	ON/OFF control
	P	Proportional control
Input	K	K thermocouple
	J	J thermocouple
	D	RTD KPt100 Ω
	P	RTD Pt100 Ω (IEC751)
	V	1 - 5 V d.c.
	C	4 - 20 mA d.c.
Control output	M	Relay output
	C	Current output (4 - 20 mA d.c.)
	S	SSR (voltage pulse output, 12 V d.c.)
Sub output (SUB) ※ Only DF2 model	N	None
	O	High deviation
	P	Low deviation
	W	High-Low deviation
Control operation (internal selection)	R	Reverse action (heating control)
	D	Direct action (except cooling)
Range code		Refer to "Range and input code chart"

※ DF4 model selects proportional control/ON-OFF control by using internal dip switch.

※ Model DF4 with 110 V power voltage is available (order-made)



Range and input code chart

Classification	Code	DF2		DF4	
		Input	Range (°C)	Input	Range (°C)
Thermocouple	4	K, J	-	K, J	0 ~ 199
	5		0 ~ 199		0 ~ 299
	6		0 ~ 299		0 ~ 399
	7		0 ~ 399		0 ~ 599
	8		-		K
RTD	1	Pt100 Ω	-99 ~ 99	Pt100 Ω	-
	2		-		-99 ~ 99
	3		-		0 ~ 99
	4		0 ~ 99		0 ~ 199
	5		0 ~ 199		0 ~ 299
	6		0 ~ 299		0 ~ 399
	7		0 ~ 399		-
DC voltage	-	1 - 5 V	0 ~ 99	1 - 5 V	0 ~ 99
DC current	-	4 - 20 mA	0 ~ 99	4 - 20 mA	0 ~ 99

Temperature Controllers

■ HY-4500S / 5000 Analog Indication Temperature Controllers

■ Specifications

Model		HY-4500S	HY-5000
Appearance			
W×H×D (mm)		96.0×96.0×125.0	72.0×72.0×109.3
Input	Thermocouple	K, J, R	
	RTD	Pt100 Ω, K Pt100 Ω (139.6 Ω at 100 °C)	
	DC voltage input	1 - 5 V d.c., 4 - 20 mA d.c.	
	Lead wire allowable resistance	RTD max. 10 Ω. (but the resistance among 3 lines should be same)	
Performance	Degree of indication	±2 % of FS ±1 Digit	
	Dielectric strength	2000 V a.c. 50/60 Hz for 1 min (between different live parts)	
Control functions and output	Control type	Proportional control, ON/OFF control (by suffix code)	
	Control operation	Reverse action or direct action (by suffix code)	
	Setting range	Same as input range chart	
	Proportional band	1 ~ 10 % of FS (HY-4500 variable) (3 % of FS fixed for HY-5000)	
	Manual reset (MR)	±10 % of MV (output amount)	
	Proportional period	Approx. 25~30 sec (Relay output), Approx. 2~4 sec (voltage output (SSR))	
	Hysteresis	Approx. 2 % of FS, fixed (ON/OFF control)	
	Input disconnection detection	Output OFF when range is over 10 °C	
	Sub output setting range	Approx. 50 °C for setting (400 °C range standard)	
Control output	Relay output	Contacts: 1 c, 250 V a.c. 3 A (resistive load)	
	Voltage output (SSR)	Approx. 12 V d.c. (load resistance min. 800 Ω)	
	Current output (SCR)	4 - 20 mA d.c. (load resistance max. 600 Ω)	
Power voltage		110/220 V a.c. 50/60 Hz	
Voltage fluctuation rate		±10 % of power voltage	
Power consumption		Max. 3 VA	
Ambient temperature & humidity		0 - 50 °C, 35 ~ 85 % RH (without condensation)	
Storage temperature		-25 ~ 65 °C	
Vibration resistance		10 - 55 Hz, single amplitude 0.76 mm, 3 axes each direction, 1h	
Shock resistance		300 m/s ² , 6 directions, each 3 times	
Weight		600 g	450 g

■ Suffix code

Model	Code						Content
HY-	<input type="checkbox"/>	<input type="checkbox"/>	<input type="checkbox"/>	<input type="checkbox"/>	<input type="checkbox"/>	<input type="checkbox"/>	Analog Indication Temperature Controller
Appearance	4500S						96(W) X 96(H) mm
	5000						72(W) X 72(H) mm
Control type	F						ON/OFF control (2 position control)
	P						Proportional control
Input	K						K thermocouple
	J						J thermocouple
	R						R thermocouple
	D						RTD KPt100 Ω
	P						RTD Pt100 Ω (IEC)
	V						1 - 5 V d.c.
	C						4 - 20 mA d.c.
Control output	M						Relay
	C						Current output (4 - 20 mA d.c.)
	S						SSR (12 V d.c. Voltage pulse output)
Control operation	R						Reverse action (heating control)
	D						Direct action (except cooling)
Range code							Refer to "Range and input code chart"



■ Range and input code chart

Code	HY-4500S		HY-5000	
	Input	Range (°C)	Input	Range (°C)
1	Pt100 Ω	-50 ~ 50	Pt100 Ω	-50 ~ 50
3	Pt100 Ω	-50 ~ 100	Pt100 Ω	-0 ~ 100
5	Pt100 Ω	0 ~ 100	K, Pt100 Ω	0 ~ 200
6	-	-	K, Pt100 Ω	0 ~ 300
7	K, Pt100 Ω	0 ~ 200	K, Pt100 Ω	0 ~ 400
8	K, Pt100 Ω	0 ~ 300	K	0 ~ 600
9	K, J, Pt100 Ω	0 ~ 400	K	0 ~ 800
10	K	0 ~ 600	K	0 ~ 1200
11	K	0 ~ 800	-	-
13	K	0 ~ 1200	-	-
14	R	0 ~ 1600	-	-

Temperature Controllers

■ AF1 Deviation Indicating Temperature Controllers

■ Specifications

Model		AF1	AF1(SUB)
Appearance			
W×H×D (mm)		48.0×96.0×100.0	
Input	Thermocouple	K	
	RTD	Pt100 Ω	
	Allowable signal source resistance	Thermocouple (max. 100 Ω)	
	Lead wire allowable resistance	RTD max. 10 Ω. (but the resistance among 3 lines should be same)	
Performance	Degree of indication	±1.0 % of FS	
	Dielectric strength	2000 V a.c. 50/60 Hz for 1 min (between different live parts)	
Control functions and output	Control type	Proportional control, ON/OFF control (by suffix code)	
	Control operation	Reverse action or direct action (by suffix code)	
	Setting range	Same as input range chart	
	Proportional band	±3 % of FS (fixed)	
	Manual reset (MR)	±10 % of MV (output amount)	
	Proportional period	Approx. 25~30 sec (Relay output), approx. 2~4 sec (voltage output (SSR))	
	Hysteresis	Approx. 2 % of FS, fixed (ON/OFF control, 400 °C standard)	
	Input disconnection detection	Output OFF when range is over	
	Sub output (SUB)	High/low limit, high/low limit operation(refer to the suffix code)	
	Sub output setting range	Approx. 50 °C for setting (400 °C range standard)	
	Sub output hysteresis	1 °C fixed	
Control output	Relay output	Contacts: 1 a, 1 b, 250 V a.c. 5 A (resistive load)	
	Voltage output (SSR)	Approx. 12 V d.c. (load resistance min. 800 Ω)	
	Current output (SCR)	4 - 20 mA d.c. (load resistance max. 600 Ω)	
Sub output (SUB)	Relay output	Contacts: 1a, 250 V a.c. 3 A (resistive load)	
Power voltage		110/220 V a.c., 60 Hz	
Voltage fluctuation rate		±10 % of power voltage	
Power consumption		Max. 3 VA	
Ambient temperature & humidity		0 ~ 50 °C, 35 ~ 85 % RH (without condensation)	
Storage temperature		-25 ~ 65 °C	
Weight		350 g	

■ Suffix code

Model	Code						Content
AF1	<input type="checkbox"/>	<input type="checkbox"/>	<input type="checkbox"/>	<input type="checkbox"/>	<input type="checkbox"/>	<input type="checkbox"/>	Deviation Indicating Temperature Controller
Control type	F						ON / OFF control (2 position control)
	P						Proportional control
Input	K						K thermocouple
	P						RTD Pt100 Ω (IEC 751)
Control output	M						Relay
	C						Current output (4 - 20 mA d.c)
	S						SSR (12 V d.c Voltage pulse output)
Sub output (SUB)	N						None
	O						High limit operation
	P						Low limit operation
	W						High/low limit operation
Control operation	R						Reverse action (heating control)
	D						Direct action (cooling control)
Range code		Refer to "Range and input code chart"					





■ Range and input code chart

Code	AF1	
	Input	Range (°C)
1	Pt100 Ω	-99 ~ 99
4	Pt100 Ω	0 ~ 99
5	K, Pt100 Ω	0 ~ 199
6	K, Pt100 Ω	0 ~ 299
7	K, Pt100 Ω	0 ~ 399

Temperature Controllers

■ HY-2000, HY-1000, ND4 Temperature Controllers Without Indicator

■ Specifications

Model		HY-2000	HY-1000	ND4	ND4 (for socket)
Appearance					
W×H×D (mm)		96.0×96.0×103.9	72.0×72.0×109.2	48.0×48.0×79.5	48.0×48.0×78.0
Input	Thermocouple	K, J (J Type is for HY-2000 only)			
	RTD	Pt100 Ω (IEC751)			
	Allowable signal source resistance	Max. 100 Ω (thermocouple input)			
	Lead wire allowable resistance	RTD max. 10 Ω. (but the resistance among 3 lines should be same)			
Control functions and output	Control type	Proportional control, ON/OFF control (by suffix code)			
	Control operation	Reverse action or direct action (by suffix code)			
	Setting range	Same as input range chart			
	Proportional band	3 % of FS (fixed)			
	Proportional period	Approx. 25 ~ 30 sec (Relay output), Approx. 2 ~ 4 sec (voltage output (SSR))			
	Hysteresis	Approx. 2 % of FS, fixed (ON/OFF control, 400 °C standard)			
	Input disconnection detection	Output OFF when range is over			
Control output		Relay (1 c, 250 V a.c., 3 A resistive load)			
Power voltage		110/220 V a.c. 60 Hz (but for ND4, 110V a.c. or 220V a.c. are separated)			
Voltage fluctuation rate		±10 % of power voltage			
Power consumption		Max. 3 VA			
Dielectric strength		2000 V a.c. 50/60 Hz for 1 min (between different live parts)			
Ambient temperature & humidity		0 ~ 50 °C, 35 ~ 85 % RH (without condensation)			
Storage temperature		-25 ~ 65 °C			
Weight		400 g		200 g	

■ Suffix code

Model	Code							Content
HY-1000								Temperature Controller Without Indicator
HY-2000	□	□	□	□	□	□	□	
ND4								
Control type	F							ON/OFF control (2 position control)
	P							Proportional control
Input	K							K thermocouple
	J							J thermocouple
	P							RTD Pt100 Ω (IEC751)
Control output	M							Relay
Alarm output	N							None (※ For ND4 model, no indication)
Control operation	R							Reverse action (heating control)
	D							Direct action (cooling control)
Range code								Refer to "Range and input code chart"
Terminal structure	T							ND4 terminal type

■ Range and input code chart

Code	HY-2000		HY-1000		ND4	
	Input	Range (°C)	Input	Range (°C)	Input	Range (°C)
1	-	-	Pt100 Ω	-50 ~ 50	Pt100 Ω	-50 ~ 50
2	Pt100 Ω	-50 ~ 100	-	-	Pt100 Ω	-100 ~ 100
3	-	-	Pt100 Ω	0 ~ 100	Pt100 Ω	0 ~ 100
4	K, J, Pt100 Ω	0 ~ 100	-	-	-	-
5	K, J, Pt100 Ω	0 ~ 200	K, Pt100 Ω	0 ~ 200	K, Pt100 Ω	0 ~ 200
6	K, J, Pt100 Ω	0 ~ 300	K, Pt100 Ω	0 ~ 300	K, Pt100 Ω	0 ~ 300
7	K, J, Pt100 Ω	0 ~ 400	K, Pt100 Ω	0 ~ 400	K, Pt100 Ω	0 ~ 400
8	K	0 ~ 600	K	0 ~ 600	-	-
9	K	0 ~ 800	K	0 ~ 800	-	-
10	-	-	K	0 ~ 1200	-	-
11	K	0 ~ 1200	-	-	-	-

※ Specify the power voltage of ND4 separately (110 V a.c. or 220 V a.c.)

Temperature Controllers

BR6A Temperature Controllers For Refrigerators

Specifications

Model	BR6A	
Appearance		
W×H×D (mm)	74.9×32.9×69.3	
Power consumption	Max. 5 VA (220V a.c. 60 Hz)	
Input sensor	Hanyoung Nux exclusive sensor (TH-570N) ※ Thermistor (-50.0 ~ 150.0 °C)	
Accuracy	±1 % of FS ±1 Digit	
Control output (Main output)	Relay output	Contact configuration: 1c, 250V a.c. 5A (resistive load) 10 V d.c. min (load resistance min. 500 Ω)
Alarm / Defrost	Relay	Contact configuration: 1c, 250 V a.c. 5A (resistive load)
Control operation	Proportional operation (P control), ON/OFF operation	
Setting method	Set, increase, decrease, digital method by shift key	
Other features	Defrost timer, alarm function, heating/cooling dual usage	
Ambient temperature & humidity	0 ~ 50 °C, 35~85 % RH (without condensation)	
Line resistance	Max. 10 Ω for 1 wire	
Weight	120 g	

Suffix code

Model	Code	Content
BR6A -	<input type="checkbox"/> <input type="checkbox"/> <input type="checkbox"/> <input type="checkbox"/> - <input type="checkbox"/>	Digital Temperature Controller (Proportional control, ON/OFF control selectable by setting)
Input	N	Hanyoung Nux exclusive sensor (TH-570N) ※Thermistor
Control output	M	Relay Contact outputs
	S	SSR output (Voltage pulse 12V d.c.)
Option	0	None (basic specifications: alarm output 1 contact)
	1	Communication (RS485, MODBUS ASCII / RTU)
Power voltage	P4	100 - 240 V a.c. 50/60 Hz
LED color	W	White LED
	R	Red LED

BR6 Temperature Controllers For Refrigerators CE

Specifications

Model	BR6	
Appearance		
W×H×D (mm)	77.0×35.0×70.5	
Power voltage	100 - 240 V a.c. 50/60 Hz, 10 - 24 V a.c. / d.c. 50/60 Hz	
Power consumption	Max. 5 VA (220 V a.c. 60 Hz)	
Input sensor	Hanyoung Nux exclusive sensor (TH-540N) ※ Thermistor (NTC) (-40.0 ~ 90.0 °C)	
Accuracy	±1 % of FS ±1 digit	
Control output (Main Output)	Relay output	Contact configuration: SPDT, 250 V a.c., 5 A (resistive load) Approx. 5 V d.c. (load resistance min. 500 Ω) max. approx. 50 mA
Control type	ON / OFF, Proportional control selectable by setting	
Setting method	Set, increase, decrease, digital method by key	
Other features	Defrost timer, alarm function, heating / cooling dual usage	
Ambient temperature & humidity	0 ~ 50 °C, 35 ~ 85 % RH (without condensation)	
Weight	116 g	

Suffix code

Model	Code	Content
BR6-	<input type="checkbox"/> <input type="checkbox"/> <input type="checkbox"/> <input type="checkbox"/>	Digital Temperature Controller (basic specifications: alarm output 1 contact)
Control type	F	ON/OFF, Proportional control selectable by setting
Input	N	Hanyoung Nux exclusive sensor (TH-540N) ※ Thermistor
Control output	M	Relay
	S	SSR (Voltage pulse output 5 V d.c.)
Power voltage	P3	10 - 24 V a.c. / d.c. 50/60 Hz
	P4	100 - 240 V a.c. 50/60 Hz

Temperature Controllers

ED6 Cost-Effective Digital Temperature Controllers

Specifications

Model		ED6
Appearance		
W×H×D (mm)		77.0×35.0×70.5
Power voltage		100 - 240 V a.c. 50/60 Hz, 10 - 24 V a.c. / d.c. 50/60 Hz
Power consumption		5.5 VA
Input sensor		K, Pt100 Ω, 4 - 20 mA d.c., 1 - 5 V d.c.
Accuracy		± 0.5 % of FS ±1 Digit
Control output	Relay output	Contact configuration: 1 c, 250 V a.c. 5 A (resistive load)
	SSR	Approx. 5 V d.c.. (load resistance min. 500 Ω), max. approx. 50 mA
Control type		Proportional control, ON/OFF control selectable by setting
Setting method		Set, increase, decrease, digital method by key
Other features		Sub output (alarm, defrost timer), heating / cooling dual usage
Ambient temperature & humidity		0 - 50 °C, 35 ~ 85 % RH (without condensation)
Weight		116 g

Suffix code

Model	Code	Content
ED6	<input type="checkbox"/> <input type="checkbox"/> <input type="checkbox"/> <input type="checkbox"/> <input type="checkbox"/>	Digital Temperature Controller
Control type	F	ON/OFF, Proportional control selectable by setting
Input	K	Thermocouple K
	P	RTD Pt100 Ω (IEC751)
	C	4 - 20 mA d.c. (external resistance 250 Ω installation), 1 - 5 V d.c.
Control output	M	Relay output
	S	SSR (Voltage pulse output 5 V d.c.)
Option	A	Alarm or defrost timer (alarm or Defrost)
	N	None
Power voltage	P3	10 - 24 V a.c. / d.c. 50/60 Hz
	P4	100 - 240 V a.c. 50/60 Hz

HD6 Cost-Effective Digital Temperature Controllers

Specifications

Model		HD6
Appearance		
W×H×D (mm)		77.0×35.0×70.5
Power voltage		100 - 240 V a.c. 50/60 Hz
Power consumption		Max. 2 VA
Input sensor		TH-540N (103ET: -40.0 ~ 90.0 °C, 2 m ~ 20 m)
Accuracy		±1 % + 1 Digit of display value
Control output (relay contact)		OPEN OUT: 250 V a.c. 5 A, CLOSE OUT: 250 V a.c. 5 A
Control type		ON/OFF control (control by temperature and time)
Setting method		Digital method by FND and button
Other features		Green house operation / window closing motor control output
Ambient temperature & humidity		0 ~ 50 °C, 35 ~ 85 % RH (without condensation)
Weight		116 g

Suffix code

Model	Code	Content
HD6	<input type="checkbox"/> <input type="checkbox"/> <input type="checkbox"/> <input type="checkbox"/>	Cost-Effective Digital Temperature Controller
Control type	F	ON/OFF control
Input	N	Hanyoung Nux exclusive sensor (TH-540N) ※ Thermistor
Control output	M	Relay
Power voltage	P4	100 - 240 V a.c. 50/60 Hz

Temperature Controllers

■ RS6 Temperature Controllers For Refrigerators

■ Specifications

Model		RS6		Temperature Controllers
Appearance				Recorders
W×H×D (mm)		72.0×36.0×70.0		Digital Counter/ Timers
Input	Thermocouple input	K		Analog Timers
	RTD input	Pt100 Ω		Multi Pulse Meters
	Input sampling cycle	500 ms		
	Input display resolution	0.1 °C display selection (basically below minimum display value)		Panel Meters
	Input impedance	Thermocouple (10 MΩ), RTD (200 kΩ)		
	Allowable signal source resistance	Thermocouple (max. 250 Ω) DC voltage (max. 2 kΩ)		Peripheral Devices
	Allowable wiring resistance	RTD (max. 10 Ω. but the resistance among 3 lines should be same)		
	Input correction	±9.9 °C		Proximity Sensors
Input disconnection detection	Control output OFF when maximum or minimum range is exceeded			
Performance	Accuracy	±1 % of FS ±1 Digit		Photo Sensors
	Insulation resistance	Min. 20 MΩ (500 V d.c.)		
	Dielectric strength	2000 V a.c. 50/60 Hz for 1 min (between different live parts)		
Control functions and output	Control type	For ON/OFF control only		Rotary Encoders
	Control operation	Reverse action (heating) or direct action (cooling) selection		Thyristor Power Regulators
	ON/OFF control hysteresis	0.0 ~ 9.9 °C		
	ON/OFF control output delay time	0 ~ 9 minutes		Solid State Relays
	Alarm type	High alarm, low alarm, hold high alarm, hold low alarm		
	Alarm setting range	Input range		
	Output	Control output	Relay	Contact configuration: 1 c contact. 250 V a.c., 3 A (resistive load)
Alarm output		Relay (AL-1, AL-2)	Contact configuration: 1 A contact. 250 V a.c., 3 A (resistive load)	Control Switches / Combination Display Lights
Power voltage		12 V a.c. 60 Hz		Power / Main / Cam Switches
Voltage fluctuation rate		±10% of power voltage		Limit Switches
Power consumption		Max. 5 VA		
Ambient temperature & humidity		0 ~ 50 °C, 35 ~ 85 % RH (without condensation)		Micro Switches
Storage temperature		-25 ~ 65 °C		
Vibration resistance		10 - 55 Hz, single amplitude 0.76 mm, 3 axes each direction, 2 min		Foot / Mono Lever / Pendant Switches
Shock resistance		300 m/s², 6 directions, each 3 times		



■ Suffix code

Model	Code	Content	Signal Lights
RS6	□	Digital Temperature Controller (basic specifications: alarm output 2 contacts)	Power Buzzers / Terminal Blocks Fuse Holders / Control Boxes
Input	K	K thermocouple	
	P	RTD Pt 100 Ω (IEC 751)	

Temperature Controllers

■ AT series Digital Temperature Indicators

Specifications

Model		AT3	AT6
Appearance			
W×H×D (mm)		96.0 X 48.0 X 100.0	72.0 X 36.0 X 94.5
Input	Thermocouple	K, R	K, J
	DC voltage	-	0 - 5 V, 1 - 5 V, 0 - 10 V
	DC current	-	4 - 20 mA d.c.
	RTD	Pt100 Ω (IEC 751).	
	Input sampling cycle	500 ms	
	Input display resolution	1 °C / 0.1 °C	
	Input impedance	1 MΩ (thermocouple and DC voltage)	
	Allowable signal source resistance	Thermocouple (max. 100 Ω)	Thermocouple (max. 100 Ω), DC voltage (max. 2 kΩ)
Lead wire allowable resistance	RTD (max. 10 Ω) but the resistance among 3 lines should be same		
Performance	Display accuracy	±0.5 % of FS	
	Dielectric strength	2000 V a.c. 50/60 Hz for 1 min (among different live parts)	
Power voltage		110/220 V a.c. 50/60 Hz	100 - 240 V a.c. 50/60 Hz
Voltage fluctuation rate		±10 % of power voltage	
Power consumption		Max. 4 VA	Max. 5 VA
Ambient temperature		0 ~ 50 °C	
Storage temperature		-25 ~ 65 °C	
Weight		Approx. 282 g	Approx. 150 g

Suffix code

Model	Code	Content
AT	□-□	Digital Temperature Indicator
Appearance	3	96 (W) × 48 (H) mm
	6	72 (W) × 36 (H) mm
AT3 input	KP	K thermocouple, RTD Pt100 Ω K thermocouple / RTD input selection by internal dip switch
	R	R thermocouple
AT6 input	K	K thermocouple
	J	J thermocouple
	P1	RTD Pt100 Ω (-199 ~ 600 °C range)
	P2	RTD Pt100 Ω (-199.9 ~ 199.9 °C range)
	G	0 - 5 V d.c.
	V	1 - 5 V d.c.
	F	0 - 10 V d.c.
	C	4 - 20 mA d.c.

Range and input code chart

● AT3

Classification	Code	Input	Range (°C)
Thermocouple	R	R	599 ~ 1699
	K	K (front dip switch)	0 ~ 1,300
			0.0 ~ 199.9
RTD	P	Pt100 Ω (front dip switch)	-199 ~ 600
			-199.9 ~ 199.9

● AT6

Classification	Code	Input	Range (°C)
Thermocouple	K	K thermocouple	0 ~ 1,200
	J	J thermocouple	0 ~ 600
RTD	P1	Pt100 Ω	-199 ~ 600
	P2		-199.9 ~ 199.9
DC voltage	G	0 - 5 V d.c.	0 ~ 100
	V	1 - 5 V d.c.	0 ~ 100
	F	0 - 10 V d.c.	0 ~ 100
DC current	C	4 - 20 mA d.c.	0 ~ 100

Temperature Controllers

■ BK3 Digital Temperature Indicators

■ Specifications

Model		BK3
Appearance		
W×H×D (mm)		96.0×48.0×100.2
Input	Thermocouple	K, J, R (but "R" type thermocouple only applies to BK3 models)
	Input sensor	RTD : Pt100 Ω (IEC 751)
	DC voltage	0 - 5 V d.c., 1 - 5 V d.c., 0 - 10 V d.c.
	DC current	4 - 20 mA d.c.
	Input sampling cycle	500 ms
	Input display resolution	Basically below 1 °C (0.1 °C) of present value
	Input impedance	1 MΩ (Thermocouple and DC voltage)
	Allowable signal source resistance	Thermocouple (max. 100 Ω), DC voltage (max. 2 kΩ)
	Lead wire allowable resistance	RTD (max. 10 Ω) but the resistance among 3 lines should be same
Allowable input voltage	Within ±10 V d.c. (thermocouple, RTD, DC voltage)	
Performance	Display accuracy	±0.5 % of FS ±1 Digit (but, for R input, 599 °C max. is not guaranteed)
	Insulation Resistance	Min. 20 MΩ (500 V d.c.)
	Dielectric strength	2000 V a.c. 50/60 Hz for 1 min (between different live parts)
Power voltage		110/220 V a.c. 50/60 Hz
Voltage fluctuation rate		±10 % of power voltage
Power consumption		Max. 4 VA
Ambient temperature		0 ~ 50 °C
Storage temperature		-25 ~ 65 °C
Vibration resistance		10 - 50 Hz, single amplitude X · Y · Z each direction, 2h
Shock resistance		300 m/s ² X · Y · Z each direction each 3 times
Weight		350 g

■ Suffix code

Model	Code	Content
BK3-	□	Digital Temperature Indicator
Input	K	K thermocouple (refer to range and input code chart)
	K1	
	J	J thermocouple
	R	R thermocouple
	P1	RTD Pt100 Ω (refer to range and input code chart)
	P2	
	G	0 - 5 V d.c.
	V	1 - 5 V d.c.
	F	0 - 10 V d.c.
C	4 - 20 mA d.c.	

■ Range and input code chart

Classification	Code	Input	Range (°C)
Thermocouple	K	K thermocouple	0 ~ 1,300 °C
	K1		0.0 ~ 200.0
	J	J thermocouple	0 ~ 400
	R	R thermocouple	599 ~ 1,699
RTD	P1	Pt100 Ω	-199 ~ 600 °C
	P2		-199.9 ~ 199.9 °C
Direct voltage	G	0 - 5 V d.c.	0 ~ 100
	V	1 - 5 V d.c.	
	F	0 - 10 V d.c.	
Direct current	C	4 - 20 mA d.c.	

Temperature Controllers

TP3 5-Channel Digital Temperature Indicators

Specifications

Model		TP3	
Appearance			
W×H×D (mm)		96.0×48.0×100.0	
Input	Input	By suffix code (5 contacts of the same input)	
	Thermocouple	K, J	
	RTD	Pt100 Ω (IEC 751)	
	Input sampling cycle	500 ms	
	Input display resolution	Basically 1 °C max	
	Input impedance	Thermocouple and DC voltage input (mV): min. 1 MΩ. DC voltage input(V): approx. 1 MΩ	
	Allowable signal source resistance	Thermocouple (max. 250 Ω) DC voltage (max. 2 kΩ)	
	Allowable wiring resistance	RTD max. 10 Ω (but the resistance among 3 lines should be same)	
	Allowable input voltage	Within ±10 V (thermocouple, RTD, DC voltage (mV)). within ±20 V (DC voltage (V))	
	Input correction	Correction by internal parameter	
Reference contact compensation error	± 2.0 °C (0 ~ 50 °C)		
Performance	Accuracy	Thermocouple	±(0.5% ±1 digit of displayed value) or ±3 °C (the bigger)
		RTD input	±(0.5% ±1 digit of displayed value) or ±2 °C (the bigger)
	Insulation resistance	Min. 20 MΩ (500 V d.c.)	
	Dielectric strength	2000 V a.c. 50/60 Hz for 1 min (between different live parts)	
Power voltage		100 - 240 V a.c., 50/60 Hz	
Voltage fluctuation rate		±10 % of power voltage	
Power consumption		Max. 5 VA	
Ambient temperature & humidity		0 ~ 50 °C, 35 ~ 85% RH (without condensation)	
Storage temperature		-25 ~ 65 °C	
Weight		400 g	

Suffix code

Model	Code	Content
TP3 -	<input type="checkbox"/> <input type="checkbox"/>	5-Channel Temperature Indicator
Input	K	K thermocouple
	J	J thermocouple
	P	RTD Pt 100 Ω (IEC 751)
Power voltage	P4	100 - 240 V a.c. 50/60 Hz

Temperature Controllers

■ BK6-M Multi Input Digital Temperature Indicators

■ Specifications

Model		BK6-M	
Appearance			
W×H×D (mm)		72.0×36.0×87.5	
Input	Input	Multi Input selectable by setting	
	Thermocouple	K, J, E, T, R, B, S, L, N, U, W, PL2	
	RTD	Pt100 Ω (IEC 751), KPt100 Ω	
	Input sampling cycle	500 ms	
	DC voltage	1 - 5 V (4 - 20 mA), -10 - 20 mV, 0 - 100 mV	
	Input impedance	Thermocouple and DC voltage input (mV): min. 1 MΩ. DC voltage input(V): approx. 1 MΩ	
	Allowable signal source resistance	Thermocouple (max. 100 Ω) DC voltage (max. 2 kΩ)	
	Allowable wiring resistance	RTD max. 10 Ω (but the resistance among 3 lines should be same)	
	Allowable input voltage	Within ±10 V (thermocouple, RTD, DC voltage (mV)). within ±20 V (DC voltage (V))	
	Input correction	Correction by internal parameter	
Reference contact compensation error	±2.0 °C (0 ~ 50 °C)		
Performance	Accuracy	Thermocouple	±0.5 % of FS ±1 Digit
		RTD	±0.5 % of FS ±1 Digit
		DC voltage / current	±0.5 % of FS ±1 Digit
	Insulation resistance	Min. 20 MΩ (500 V d.c.)	
	Dielectric strength	2000 V a.c. 50/60 Hz for 1 min (between different live parts)	
Power voltage	100 - 240 V a.c. 50/60 Hz		
Voltage fluctuation rate	±10 % of power voltage		
Power consumption	Max. 4 VA		
Ambient temperature & humidity	0 ~ 50 °C, 35 ~ 85% RH (without condensation)		
Storage temperature	-25 ~ 65 °C		
Weight	120 g		

■ Suffix code

Model	Code	Content
BK6-M	□	Multi Input Digital Temperature Indicator
Option	0	None
	1	RET (Retransmission output 4 - 20 mA d.c.)

Temperature Controllers
Recorders
Digital Counter/ Timers
Analog Timers
Multi Pulse Meters
Panel Meters
Peripheral Devices
Proximity Sensors
Photo Sensors
Rotary Encoders
Thyristor Power Regulators
Solid State Relays
Power Supplies
Control Switches / Combination Display Lights
Power / Main / Cam Switches
Limit Switches
Micro Switches
Foot / Mono Lever / Pendant Switches
Signal Lights
Power Buzzers / Terminal Blocks Fuse Holders / Control Boxes

Temperature Controllers

■ HN100 Digital Temperature Indicators

Specifications

Model		HN100	
Appearance			
W×H×D (mm)		275.0×170.0×34.4	
Input	Input sensor	RTD : Pt100 Ω (IEC 751)	
	Input sampling cycle	500 ms	
	Input display resolution	Basically below 1 °C (0.1 °C) of present value	
	Allowable wiring resistance	RTD (max. 10 Ω, but the resistance among 3 lines should be same)	
Performance	Accuracy	RTD	±(0.5% ±1 digit of displayed value) or ±2 °C (the bigger)
		4 - 20 mA d.c.	
	Insulation resistance	Min. 20 MΩ (500 V d.c.)	
	Dielectric strength	2000 V a.c. 50/60 Hz for 1 min (between different live parts)	
Power voltage		12 V d.c. (power line length: 1.8 m standard)	
Voltage fluctuation rate		±10 % of power voltage	
Power consumption		Max. 5 VA	
Ambient temperature		-10 ~ 70 °C	
Storage temperature		-25 ~ 80 °C	
Weight		1,900 g	

■ Suffix code

Model	Code	Content
HN100-	<input type="checkbox"/> <input type="checkbox"/>	Digital Temperature Indicator
Input	1	RTD Pt100 Ω
	2	4 - 20 mA d.c. (measuring range: 0~100 °C fixed)
Measuring range	1	-100 ~ 400 °C
	2	-19.9 ~ 99.9 °C

GR2000 Touch Screen Graphic Recorders

Specifications

Model		GR2000	
Appearance		 <p>12.1"</p>	
W×H×D (mm)		294.0×294.0×126.3	
Power voltage		100 - 240 V a.c. (voltage fluctuation rate ± 10%)	
Power frequency		50/60 Hz	
Max. power consumption		40 VA or 40 W	
Input	Channels	6 channels, 12 channels, 18 channels, 24 channels, 30 channels, 36 channels, 42 channels, 48 channels, 54 channels, 60 channels (refer to the suffix code)	
	Input	<ul style="list-style-type: none"> ● RTD input 2 types (Pt-100, KPt-100), ● Thermocouple input 12 types (K, J, E, T, R, B, S, L, N, U, Wre 5-26, PL-II), ● DC voltage input 4 types (-10 - 20 mV, 0 - 100 mV, 1 - 5 V, 0 - 30 V) 	
	Sampling cycle	250 ms	
	Accuracy	±0.15% of FS ±1 digit (RJC temperature error excluded) ※ Refer to input table	
	RJC temperature error	±1.5 °C (0 ~ 50 °C)	
	Burnout function	UP-Scale during disconnection	
Storage functions	Internal memory	Non-volatile memory: 400 MB - Store approx. 20 days in 1 second cycle (60 channels)	
	External memory	SD card (32GB): store approx. 5 years in 1 second cycle (60 channels) ※SDHC support, USB memory	
	Saving interval	User settings (1, 2, 5, 10, 20, 30, 60, 120 sec)	
	Memory information	Measured value for each channel, burn-out, DI input (contact input), ALARM, relay output status	
Display specifications	Display	12.1" SVGA TFT color LCD (246.0 × 184.5 mm, Resolution 800 × 600 pixel, LED Back light)	
	Languages	Korean, English, Chinese (simplified, traditional)	
	Screen	Horizontal trend, text view, bar graph, mixed, zoom	
DI (option)	External digital input (DI)	5 contacts, 10 contacts	
	Input	Non-voltage contact input	
DO (option)	Contact outputs	16 contacts, 32 contacts (NO)	
	Contact point	3 A 250 V a.c. (3 A 30 V d.c.)	
Weight		Approx. 5.8 kg	

Suffix code

Model	Code	Content
GR2000 -	<input type="checkbox"/> <input type="checkbox"/> <input type="checkbox"/>	Touch Screen Graphic Recorder
Input channel	06	6 channels
	12	12 channels
	18	18 channels
	24	24 channels
	30	30 channels
	36	36 channels
	42	42 channels
	48	48 channels
	54	54 channels
External contact input/output (DI / DO)	N	DI, relay None
	A	DI 5 contacts + relay 16 contacts
	B	DI 10 contacts + relay 32 contacts
Communication function	N	No communication
	A	RS232/485/422
	B	RS232/485/422, ETHERNET

Recorders

GR200 Touch Screen Graphic Recorders

Specifications

Model		GR200
Appearance		
W×H×D (mm)		145.0×145.0×173.5
Power voltage		100 - 240 V a.c. (voltage fluctuation rate ±10 %)
Power frequency		50/60 Hz
Power consumption		Max. 22 VA
Input	Channels	2 channels, 4 channels, 8 channels, 12 channels (refer to the suffix code)
	Input	<ul style="list-style-type: none"> ● RTD input 2 types (Pt-100, KPt-100), ● Thermocouple input 12 types (K, J, E, T, R, B, S, L, N, U, Wre 5-26, PL-II), ● DC voltage input 4 types (-10 - 20 mV, 0 - 100 mV, 1 - 5 V, 0 - 30 V)
	Sampling cycle	250 ms
	Accuracy	±0.15 % of FS ±1 digit (RJC temperature error excluded)
	RJC temperature error	±1.5 °C (0 ~ 50 °C)
	Burnout function	UP-Scale during disconnection
Alarm	Alarm setting	2 alarm settings per channel
	Alarm type	High/low limit, High/low limit within/out of range, etc.
Storage functions	Internal memory	Non-volatile memory: 80 MB -15 days in 1 second cycle
	External memory	SD card (2GB): store approx. 1 year in 1 second cycle ※ SDHC support
	File type	FAT 16/32 (SD card)
	Saving interval	User settings (1, 2, 5, 10, 20, 30, 60, 120 sec)
	Trend screen LIST function	Enter and display user messages on the graph
Display Specifications	Display	TFT color LCD (115.2 mm × 86.4 mm, 640 × 480 pixel) LED Back light
	Languages	Korean, English, Chinese (simplified, traditional)
	Screen	Horizontal trend, text view, bar graph
	View saved history	Select, display, zoom, reduce saved data
DI (option)	External digital input (DI)	2 contacts, 4 contacts
	Input	Non-voltage contact input
DO (option)	Contact outputs	D6 contacts, 12 contacts (NO)
	Contact point	3 A 250 V a.c. (3 A 30 V d.c.)
Weight		Approx. 1.3 kg

Suffix code

Model	Code	Content
GR200 -	<input type="checkbox"/> <input type="checkbox"/> <input type="checkbox"/>	Touch Screen Graphic Recorder
Input channel	2	2 channels
	4	4 channels
	8	8 channels
	12	12 channels
External contact input/output (DI / DO)	N	None
	1	DI 2 contacts + Relay 6 contacts
	2	DI 4 contacts + Relay 12 contacts
Communication function	0	RS422/485
	1	Ethernet

RT9N 2-Channel Temperature Controller/Recorders

Specifications

Model	RT9N	
Appearance		
W×H×D (mm)	96.0×96.0×100.0	
Power voltage	100 - 240 V a.c. (±10 %), 50/60 Hz	
Power consumption	Max. 15 W, max. 20 VA	
Sampling cycle	250 ms	
Input	Thermocouple: K, J, E, T, R, S, B, L, N, U, WRe 5 - 26, PL- II RTD: Pt 100 Ω, KSPt 100 Ω DC voltage: 1 - 5 V, 0 - 10 V, -10 - 20 mV, 0 - 100 mV (freescale type)	
Input display resolution	Basically below the decimal point of the measuring range table	
Input impedance	Thermocouple and DC voltage input (mV): min. 1 MΩ. DC voltage input(V): approx. 1 MΩ	
Alarm	Relay output (AL1,AL2)	
Allowable signal source resistance	Thermocouple (max. 250 Ω). DC voltage (max. 2 kΩ)	
Allowable wiring resistance	RTD max. 10 Ω. (but the resistance among 3 lines should be same)	
Allowable input voltage	Within ±10 V (thermocouple,RTD,DC voltage (mV)) Within ± 20 V (DC voltage (V)).	
Noise removal rate	NMRR (normal mode): 40 dB min , CMRR (common mode): 120 dB min (50/60 Hz ±1 %)	
Applicable standard	Thermocouple/RTD (KS/IEC 751/DIN)	
Reference contact compensation error	±1.5 °C (15 ~ 35 °C range), ±2.0 °C (0 ~ 50 °C range)	
Accuracy	Indication and record accuracy: ±0.5 % (Full Scale)	
Record	<ul style="list-style-type: none"> ● Measurement point: 1 contact ● Response time: varies according to recording speed ● Recording method: Thermal line ● Printing method: 203 dpi (8.0 dots/mm) 384 dots per line ● Recording paper speed: (20, 30, 60, 120, 180, 300, 600, 900) mm/h ● Recording paper check: If there is no recording paper, the P-END lamp on the front display window lights and recording stops ● Recording paper: width 57.5 mm, length approx. 16 m 	







Suffix code

Model	Code	Content	
RT9N-	<input type="checkbox"/> <input type="checkbox"/> <input type="checkbox"/>	2-Channel Temperature Controller/Recorder	
Control type	0	Temperature recorder only	
	1	Temperature recorder and controller	
Number of channels	1	1 channel	
	2	2 channels	
Option	0	None (AL1 built-in)	
	1	AL2	1-channel type only
	2	AL2, RS485 communication	
	3	RS485 communication	





Digital Counter / Timers

■ GE series Digital Counter / Timers

■ Specifications

Model	GE6-P4	GE6-P6	GE6-T6	GE4-P4	GE4-P6	GE4-T6
Appearance						
W×H×D (mm)	72.0×36.0×81.0			48.0×48.0×79.3		
Type	Preset method		Indication only	Preset method		Indication only
Display digits	4 digit display (9999)	6 digit display (999999)	6 digit display (999999)	4 digit display (9999)	6 digit display (999999)	6 digit display (999999)
Setting Stages	1 or 2-stage setting	1 or 2-stage setting	-	1 or 2-stage setting	1 or 2-stage setting	-
Power voltage	100 - 240 V a.c. 50/60 Hz, 24 - 60 V a.c. / d.c. (voltage fluctuation rate: ±10 %)					
Power consumption	100 - 240 V a.c.: max. approx. 13.5 VA, 24-60 V d.c.: max. approx. 5 W, 24 - 60 V a.c. max. approx. 9 VA					
Character height	11 (count value), 8 (set value)					
Maximum counting speed	1 cps, 30 cps, 1 kcps, 10 kcps selection					
Power outage compensation	10 years (non-volatile memory usage)					
Input	CP1, CP2, RESET, BATCH RESET (Except TOTAL) 4 inputs [H] level 4 V - 30 V d.c., [L] level 0 V - 2 V d.c. Internal pull-up by NPN / PNP setting, Pull-down resistor connection (4.7 kΩ)					
Minimum input signal time	START, INHIBIT, RESET minimum input signal width 1 ms / 20 ms selection					
External power supply	Max. 12 V d.c. 100 mA					
ONE SHOT output	0.01 - 99.99 s [OUT1, OUT2(OUT)]					
Control output	Contact	1-stage	SPST (1a, OUT)		SPDT (1c, OUT)	
		2-stage	SPST (1a, OUT1), SPDT (1c, OUT2)			
		Capacity	NO: 250 V a.c. 5 A, NC: 250 V a.c. 2 A, resistive load			
	Contactless	1-stage	NPN 2 contacts (OUT, BAT.O)			
		2-stage	-			
Capacity	Open collector, max. 30 V d.c. 100 mA					
Timer operation error	For power start: ±0.01 % max. ±0.05 sec For reset start: ±0.01 % ± 0.03 sec max					
Insulation Resistance	Min. 100 MΩ (500 V d.c.) conductive terminal - unfilled metal					
Dielectric strength	2000 V a.c. 60 Hz for 1 min (different live part terminals)					
Noise immunity	Square wave noise by noise simulator (1 μs pulse every 16 ms) ±2 kV (among power terminals), ±500 V (among input terminals)					
Vibration resistance	10 - 55 Hz, single amplitude 0.5 mm, 3 axes each direction, 2 h					
Shock resistance	300 m/s ² , 3 axes each direction each 3 times					
Relay life	Electrical	More than 100 thousand times (250 V a.c. 2 A resistive load)				
	Mechanical	Min. 10 million times				
Degree of protection	IP65 (IEC 60529) (product front)					
Storage temperature	-20 ~ 65 °C					
Ambient temperature & humidity	-10 ~ 55 °C, 35 ~ 85 % RH (without condensation)					
Weight	Max. 138 g			Max. 133 g		

Digital Counter / Timers

Model	GE3-P6	GE3-T6	GE7-P6	GE7-T6
Appearance				
W×H×D (mm)	96.0×48.0×102.6		72.0×72.0×87.0	
Type	Preset method	Indication only	Preset method	Indication only
Display digits	6 digit display (999999)		6 digit display (999999)	
Setting Stages	1 or 2-stage setting	-	1 or 2-stage setting	-
Power voltage	100 - 240 V a.c. 50/60 Hz, 24-60 V a.c. / d.c. (voltage fluctuation rate: ±10 %)			
Power consumption	100 - 240 V a.c.: max. approx. 13.5 VA, 24-60 V d.c.: approx. 5 W, 24 - 60 V a.c.: approx. 9 VA			
Character height	13 (count value), 10 (set value)			
Maximum counting speed	1 cps, 30 cps, 1 kcps, 10 kcps			
Power outage compensation	10 years (non-volatile memory usage)			
Input	CP1, CP2, RESET, BATCH Reset (Except TOTAL) 4 inputs [HIGH] level 4 V - 30 V d.c., [LOW] level 0 V - 2 V d.c. Internal pull-up by NPN / PNP setting, Pull-down resistor connection (4.7 kΩ)			
Minimum input signal time	START, INHIBIT, RESET minimum input signal width 1 ms / 20 ms selection			
External power supply	Max. 12 V d.c. 100 mA			
ONE SHOT output	0.01 - 99.99 s [OUT1, OUT2(OUT)]			
Control output	Contact	1-stage	SPDT (1c, OUT)	
		2-stage	SPST (1a, OUT1), SPDT (1c, OUT2)	
		Capacity	NO: 250 V a.c. 5 A, NC: 250 V a.c. 2 A, resistive load	
	Contactless	1-stage	NPN 2 contacts (OUT, BAT.O)	
		2-stage	NPN 2 contacts (OUT1, OUT2)	
Capacity	Open collector, max. 30 V d.c. 100 mA			
Timer operation error	For power start: ±0.01 % max. ±0.05 sec, for reset start: max. ±0.01 % ± 0.03 sec			
Insulation Resistance	Min. 100 MΩ (500 V d.c.) conductive terminal - unfilled metal			
Dielectric strength	2000 V a.c. 60 Hz for 1 min (different live part terminals)			
Noise immunity	Square wave noise by noise simulator (1 μs pulse every 16 ms) ±2 kV (among power terminals), ±500 V (among input terminals)			
Vibration resistance	10 - 55 Hz, single amplitude 0.5 mm, 3 axes each direction, 2 h			
Shock resistance	300 m/s ² , 3 axes each direction each 3 times			
Relay life	Electrical	More than 100 thousand times (250 V a.c. 2 A resistive load)		
	Mechanical	Min. 10 million times		
Degree of protection	IP65 (IEC 60529) (product front)			
Storage temperature	-20 ~ 65 °C			
Ambient temperature & humidity	-10 ~ 55 °C, 35 ~ 85 % RH (without condensation)			
Weight	Max. 203 g			

Suffix code

Model	Code	Content
GE-	<input type="checkbox"/> <input type="checkbox"/> <input type="checkbox"/> <input type="checkbox"/> <input type="checkbox"/>	Digital Counter / Timer
Appearance	3	96(W) X 48(H) mm
	4	48(W) X 48(H) mm
	6	72(W) X 36(H) mm
	7	72(W) X 72(H) mm
Type	P	Preset method
	T	Indication only
Display digits	4	4 digit display (9999) ※GE3, GE7 models not available
	6	6 digit display (999999)
Setting stages	1	1-stage setting
	2	2-stage setting
Power voltage	A	100 - 240 V a.c. 50/60 Hz
	D	24 - 60 V a.c. / d.c. 50/60 Hz

Digital Counter / Timers

■ LC1 Compact LCD Total Counters

■ Specifications

Model		LC1	LC1-F
Appearance			
W×H×D (mm)		48.0×24.0×54.0	
Input type		Non-voltage input	Voltage input
Power voltage		Lithium battery built-in	
Input operation		Up count	
Counting speed		1/30/100/ 1 Kcps	20 cps
Input conditions		<ul style="list-style-type: none"> ● Residual voltage when it breaks: 0.7 V ● Max. impedance when it breaks: max. 10 kΩ ● Min impedance when it opens: min. 1 MΩ 	<ul style="list-style-type: none"> ● HIGH : 24 - 240 V a.c. / 6 - 240 V d.c. ● LOW : 0 - 2 V a.c./d.c.
Reset	Input type	Non-voltage input	
	Minimum signal width	Min. 20 ms	
Battery life		More than 7 years (approx. 25 °C) ※ this is calculated value so it is not certified value (replacing cycle reference value)	
External setting switch		<ul style="list-style-type: none"> ● SW1: internal battery ON/OFF, front reset key selectable ● SW2: count speed selectable 	SW1: internal battery ON/OFF, front reset key selectable
External connection		Terminal Blocks (4P)	
Display method		7 Segment LCD (character height: 8.7 mm)	
Display digits		8 digits	
Insulation resistance		Min. 100 MΩ (500 V d.c), conductive terminal - unfilled metal	
Dielectric strength		2000 V a.c. 50/60 Hz for 1 min (conductive terminal - unfilled metal)	
Vibration resistance		10 - 55 Hz, double amplitude 0.75 mm, 3 axes each direction, 2h	
Shock resistance		300 m/s ² , 3 axes each direction each 3 times	
Ambient temperature & humidity		-10 ~ 55 °C / 35 ~ 85 % RH (without condensation)	
Storage temperature		-25 ~ 65 °C	
Degree of protection		IP66 (IEC 60529) (front side)	
Weight		58 g	

■ Suffix code

Model	Code	Content
LC1	<input type="checkbox"/>	Compact LCD Total Counter
Input signal		Non-voltage input
	F	Voltage input (24 - 240 V a.c. / 6 - 240 V d.c.)

LT1 Compact LCD Total Timers

Specifications

Model		LT1	LT1-F
Appearance			
W×H×D (mm)		48.0×24.0×54.0	
Input type		Non-voltage input	Voltage input
Power voltage		Lithium battery built-in	
Operation type		UP timer	
Time display		9999 h 59 m 59 s / 99999 h 59.9 m / 999999 h 59 m / 9999999.9 h	
Time accuracy		± 0.01 %	
Input conditions		<ul style="list-style-type: none"> ● Residual voltage when breaks: 0.7 V ● Max. impedance when breaks: max. 10 kΩ ● Min impedance when opens: min. 1 MΩ 	<ul style="list-style-type: none"> ● HIGH : 24 - 240 V a.c. / 6-240 V d.c. ● LOW : 0 - 2 V a.c. / 0-2.4 V d.c.
Start input	Input type	Non-voltage input	Voltage input
	Minimum signal width	Min. 20 ms	
Reset input	Input type	Non-voltage input	
	Min signal width	Min. 20 ms	
Battery life		More than 10 years (approx. 25 °C) ※ This is calculated value so it is not certified value (replacing cycle reference value)	
External setting switch		● SW1: internal battery ON/OFF, front reset key selectable ● SW2: Time range selection	
External connection		Terminal Blocks (4P)	
Display method		7 Segment LCD (Character height: 8.7 mm)	
Display digits		8 digits	
Insulation resistance		Min. 100 MΩ (500 V d.c.) conductive terminal - unfilled metal	
Dielectric strength		2000 V a.c 50/60 Hz for 1 min (conductive terminal - unfilled metal)	
Vibration resistance		10 - 55 Hz, double amplitude 0.75 mm, 3 axes each direction, 2h	
Shock resistance		300 m/s, 3 axes each direction each 3 times	
Ambient temperature & humidity		-10 ~ 55 °C / 35 ~ 85 % RH (without condensation)	
Storage temperature		-20 ~ 65 °C	
Degree of protection		IP66 (IEC 60529) (front side)	
Weight		58 g	







Suffix code

Model	Code	Content
LT1	<input type="checkbox"/>	Compact LCD Indicating Total Timer
Input signal		Non-voltage input (no display)
	F	Voltage input (24 - 240 V a.c. / 6 - 240 V d.c.)

Digital Counter / Timers

GF series Digital Counter / Timers

Specifications

Model		GF7-P62 / GF7-P42	GF7-P61 / GF7-P41	GF7-T60	GF4-P41	GF4-P40	GF4-P41S
Appearance							
W×H×D (mm)		72.0×72.0×112.0			48.0×48.0×90.8		48.0×48.0×71.8
Input	Input count speed	30 cps, 1K, 3K, 5K cps (selection by front volume)			30 cps, 5K cps (selection by side dip switch)		
	When ON / OFF ratio is 1: 1						
	Input signal method	PNP input (voltage input) or NPN input (non-voltage input) selection [HIGH] level 5 - 30 V d.c. [LOW] level 0 - 2 V d.c.					
	Inhibit input	Counting stops when signal is "ON" (min. 20 ms)					
	Reset	Power reset (0.5 s min), external reset (min. 20 ms), automatic reset					
Noise immunity		Square wave noise by noise simulator (1 μs pulse width), ±2 kV (between operation power terminals)					
Performance	Timer	Setting error	Max. ±0.01% ±0.05 sec (when the power is START)				
		Repetition error	Max. ±0.005 % ±0.003 sec (when START is by RESET)				
	Insulation Resistance	Min. 100 MΩ (500 V d.c. Mega, conductive terminal - exposed unfilled metal part)					
Dielectric strength		2000 V a.c. 60 Hz for 1 min (conductive terminal - exposed unfilled metal part)					
Function and output	Counter/Timer selection		Counter operation, timer operation selection				
	Input operation		Addition, subtraction, addition/subtraction selection (refer to input operating mode)				
	Output operation (counter)		F, N, C, R, K, P, Q, S, A selection (refer to output operating mode) ※ for the total counter, it is displayed as F, K output mode				
	Output method		ON Delay and OFF Delay selection by dip switch				
	OUT1 function selection		Hold, one-shot, flickering (every second) function selection (for 2-stage setting only)				
	Prescale		Preset counter only, 0.001 ~ 9999 (4 digits), 0.00001 ~ 999999 (6 digits)				
	Count value change		Constant recognition (setting can be changed during operation)				
	Power outage compensation selection		Power outage compensation / power reset selection, semi-permanent when selecting power outage compensation (EEPROM usage)				
	Number of digits		4 digits / 6 digits	6 digits (999999)	4 digits (9999)		
	Decimal point display		4 digits: 888.8 / 8888, 6 digits: 888888 / 88888.8 / 8888.88 / 888.888				
	Setting Stages		1-stage / 2-stage	None	1-stage	None	1-stage
	ONE SHOT output		0.05 sec - 5.8 sec (setting by front TM volume)			0.1 ~ 12.5 sec (setting by front TM volume)	
	External power supply		Max. 12 V d.c. 100 mA.			Max. 12 V d.c. 100 mA.	
	Character display		Height: 11 mm (4 digits), height: 10 mm (6 digits)			Height: 8 mm	
	Control output	Contact	OUT1/OUT2 (OUT): SPDT (1c), 250 V a.c. 3A, resistor installation (for 1-stage output, only OUT output is available) * GF4-P41S: SPST (1a) configuration				
		Contactless	OUT1/OUT2 (OUT): open collector, 30 V d.c., max. 100 mA (for 1-stage output, only OUT output is available)				
	Power voltage		100 - 240 V a.c. 50/60 Hz				
Voltage fluctuation rate		±10 % of power voltage					
Power consumption		GF7-P61 : approx. 7.6 VA GF7-P62 : approx. 8.7 VA	Approx. 6.4 VA	Approx. 6.2 VA			
Ambient temperature & humidity		-10 ~ 55 °C, 35 ~ 85 % RH (without condensation)					
Storage temperature		-20 ~ 65 °C					
Vibration resistance		10 - 55 Hz, double amplitude 0.75 mm, 3 axes each direction, 1 h					
Shock resistance		300 m/s, 3 axes each direction 3 times					
Weight		243 g	208 g	184 g			

Suffix code

GF7





Model	Code	Content
GF7-	<input type="checkbox"/> <input type="checkbox"/> <input type="checkbox"/> <input type="checkbox"/>	Digital Counter / Timer
Type	P	Preset method
	T	Indication only
Display digits	4	4 digit display (9999)
	6	6 digit display (999999)
Setting stages	2	2-stage setting
	1	1-stage setting
	0	Total counter
Prescale function	E	Prescale function built-in (preset counter)
	N	Prescale None (Total counter)

GF4

Model	Code	Content
GF4-	<input type="checkbox"/> <input type="checkbox"/> <input type="checkbox"/> <input type="checkbox"/>	Digital Counter / Timer
Type	P	Preset method
	T	Indication only
Display digits	4	4 digit display (9999)
Setting stages	1	1-stage setting (preset counter)
	0	Total counter
Terminal structure	N	Terminal block
	S	8-pin socket * GF4-P41S available

LC series LCD Counter / Timers

Specifications

Model	LC6	LC4	LC3	LC7	
Appearance					
W×H×D (mm)	72.0×36.0×84.1	48.0×48.0×79.5	96.0×48.0×71.1	72.0×72.0×92.9	
Power voltage	100 - 240 V a.c. 50/60 Hz (voltage fluctuation rate: ±10 %)				
Power consumption	2-stage setting: max. 12 VA. 1-stage setting: max. 11 VA				
Character height	Counting unit (10.5 mm), Setting unit (6.7 mm)	6-digit: counting unit (10.8 mm), setting unit (8 mm) 4-digit: counting unit (14 mm), setting unit (8.5 mm)	Counting unit (14.5 mm), Setting unit (10 mm)	Counting unit (17.2 mm), Setting unit (12.5 mm)	
Maximum counting speed	1 cps / 30 cps / 1 Kcps / 10 Kcps				
Power outage compensation	10 years (using non-volatile memory)				
Input	<ul style="list-style-type: none"> ● Selection of input method by external switch (voltage input / non-voltage input) ● Counter: composed of CP1, CP2, RESET, BATCH-RESET ● Timer: composed of START, INHIBIT, RESET ● Voltage input: HIGH level (5 - 30 V d.c.), LOW level (0 - 2 V d.c.), input resistance (about 4.5 kΩ) ● Non-voltage input: impedance during short-circuit (max. 1 kΩ), residual voltage during short-circuit (max. 2 V d.c.) 				
Minimum input signal time	1 ms / 20 ms (START, INHIBIT, RESET inputs)				
External power supply	Max. 12 V d.c. 100 mA				
ONE SHOT output	0.01 ~ 99.99 SEC				
Control output	Contact	1-stage setting	OUT (SPST, 1a)	OUT (SPDT, 1c)	OUT (SPDT, 1c)
		2-stage setting	OUT1 (SPST, 1a), OUT2 (SPDT, 1c) * OUT2 of LC6-P62C: SPST configuration		
	Contactless	Capacity	SPDT: NC (250 V a.c. 5A), NO (250 V a.c. 2A), resistive load		SPST: 250 V a.c. 5A, resistive load
		1-stage setting	NPN 2 circuits (OUT, BAT.O) * LC4-P61C/P41C models NPN 1 circuit configuration		
		2-stage setting	-	NPN 2 circuits (OUT1, OUT2)	NPN 2 circuits (OUT1, OUT2)
		Capacity	Open collector, max. 30 V d.c. 100 mA		
Timer operation error	Power start: max. ±0.01 % ±0.05 sec, Reset start: max. ±0.01 % ± 0.03 sec				
Communication	Protocol	Modbus-RTU			
	Communication type	RS485 (2-wire half-duplex)			
	Synchronization	Asynchronous			
	Communication speed	2,400 / 4,800 / 9,600 / 19,200 / 38,400 bps			
	Effective distance	Max. within 800 m			
	Max. connections	31 (address:1 ~ 127)			
	Response waiting time	5 ~ 99 ms			
	Start bit	1 bit (fixed)			
	Stop bit	1 bit (fixed)			
Data bit	8 bit				
Parity bit	None / Odd / Even				
Insulation Resistance	Min. 100 MΩ (500 V d.c.) conductive terminal - unfilled metal				
Dielectric strength	2000 V a.c. 60 Hz for 1 min (different live part terminals)				
Noise immunity	Square-wave noise by noise simulator (1 μs pulse every 16 ms), ±2000 V (pulse width 1 μs)				
Vibration resistance	10 - 55 Hz, single amplitude 0.5 mm, 3-axis each direction, 2 h				
Relay Life	Electrical	Min. 50,000 times			
	Mechanical	Min. 10 million times			
Degree of protection	IP66 (IEC 60529) (product front)				
Storage temperature	-20 ~ 65 °C				
Ambient temperature & humidity	-10 ~ 55 °C, 35 ~ 85 % RH (without condensation)				



Suffix code

Model	Code	Content
LC	<input type="checkbox"/> <input type="checkbox"/> <input type="checkbox"/> <input type="checkbox"/> <input type="checkbox"/> <input type="checkbox"/>	LCD Counter / Timer
Appearance	3	96(W) × 48(H) mm
	4	48(W) × 48(H) mm
	6	72(W) × 36(H) mm
	7	72(W) × 72(H) mm
Type	P	Preset Counter / Timer
Display digits	4	4 digit display (9999) ※ LC4 only
	6	6 digit display (999999)
Setting stages	1	1-stage setting
	2	2-stage setting
Sub output	N	No sub output
	C	RS485 (MODBUS-RTU)
Power voltage	A	100 - 240 V a.c. 50/60 Hz

Digital Counter / Timers

LT4 LCD Timers

Specifications



Model	LT4 (socket type)	LT4S (socket type)
Appearance		
W×H×D (mm)	48.0×48.0×65.7	
Power voltage	24 - 240 V a.c. 50/60 Hz, 24 - 240 V d.c.	
Allowable voltage fluctuation rate	±10% of power voltage	
Power consumption	Max. 4 VA (24 - 240 V a.c. 50/60 Hz) Max. 1.6 W (24 - 240 V d.c.)	Max. 4.5 VA (24 - 240 V a.c. 50/60 Hz) Max. 2 W (24 - 240 V d.c.)
Display method	Wide viewing angle negative LCD display	
Display mode	Up display and down display	
Display digits	4 digits	
Character height	PV display: 14mm, SV display: 8.5mm	
Return time	Max. 100 ms	
External connection	Socket 8-pin	
Operating time range	0.01 sec ~ 9999 hour	
External input	Input signal	-
	Input method	-
Minimum input time	-	START, INHIBIT, RESET Non-voltage input Impedance during short-circuit: max. 1 kΩ Voltage during short-circuit: max. 0.5 V Impedance during open: min. 100 kΩ
Operating time error	Power START : max. ± 0.01 % ±0.05 sec., Signal START : max. ± 0.005 % ±0.03 sec.	
Control output	Operation mode	POND / PFKF / PFKN / PINT / TWON / TWOF / S-D
	Contact configuration	Time limit 2c, instantaneous 1c + time limit 1c
	Contact capacity	250 V a.c. 3A resistive load (NO:5A, NC:3A)
Relay life	Mechanical life: min. 10 million times, Electrical life: min. 100,000 times (250 V a.c. 5A resistive load)	
Insulation Resistance	Min. 100 MΩ (500 V d.c. Mega standard, conductive terminal - exposed unfilled metal part)	
Dielectric strength	2000 V a.c. 60 Hz for 1 min (conductive terminal - exposed unfilled metal part)	
Noise immunity	± 2 kV (among operation power terminals, pulse width = 1 us, square wave noise by noise simulator)	
Vibration resistance	10 - 55 Hz (for 1 min) single amplitude 0.5 mm X, Y, Z each direction 2 hours	
Shock resistance	300 m/s ² (30G) X, Y, Z each direction 3 times	
Degree of protection	IP66 (IEC 60529) (product front)	
Ambient temperature & humidity	-10 ~ 55 °C, 35 ~ 85 % RH (without icing)	
Storage temperature	-25 ~ 65 °C (without icing)	

Suffix code

Model	Code	Content
LT4	□	LCD Timer
Control output		Time limit 2c, time limit 1c + instantaneous 1c
	S	Time limit 1c

TT series Digital Twin Timers

Specifications

Model	TT7H	TT4-P42A	TT4-P42B
Appearance			
W×H×D (mm)	72.0×72.0×63.0	48.0×48.0×87.0	48.0×48.0×87.0
Power voltage	220 V a.c. 60 Hz	100 - 240 V a.c. 50/60 Hz	
Allowable voltage fluctuation rate	±10% of power voltage		
Power consumption	Approx. 9.6 VA (with 220 V a.c. 60 Hz)	Max. 9.1 VA (220 V a.c. 60 Hz)	
Display method	ON Time display window: Red FND 4 digits (Character height: 18.7 mm) OFF Time display window: Red FND 4 digits (Character height: 14.5 mm)	PV : Character height 11 mm, SV : Character height 8 mm	
External connection method	Terminal	11-pin socket	8-pin socket
Minimum signal time	START: min. 1s	START: min. 20 ms (RST / INH)	-
Control output	Contact configuration	Output: time limit SPDT (1c)	Output A: time limit SPDT (1c), output B: time limit SPDT (1c)
	Contact capacity	● NO: 250 V a.c. 5 A (resistive load) ● NC: 250 V a.c. 2 A (resistive load)	
Relay life	Mechanical	Min. 10 million times	
	Electrical	Min. 100,000 times (250 V a.c. 3A resistive load)	
Dielectric strength	2000 V a.c. 50/60 Hz for 1 min		
Noise immunity	±2 kV (between operation power terminals), square wave noise by noise simulator (pulse width = 1μs)		
Insulation Resistance	Min. 100 MΩ (500 V d.c. mega standard, conductive terminal - exposed unfilled metal part)		
Vibration resistance	10 - 55 Hz (1 minute cycle), peak amplitude 0.75 mm X·Y·Z each direction 1 hour		
Shock resistance	300 m/s, X·Y·Z each direction 3 times		
Ambient temperature & humidity	-10 ~ 55 °C, 30 ~ 85 % RH (without condensation)		
Storage temperature	-20 ~ 65 °C		

Suffix code

● TT7H

Model	Code	Content
TT7H-	<input type="checkbox"/> <input type="checkbox"/> <input type="checkbox"/> <input type="checkbox"/>	Digital Twin Timer
Settings	P	Preset method
Display digits	4	4 digit display (9999)
Control output	1	1-stage output
External connection	A	9-pin terminal type (external input)

● TT4

Model	Code	Content
TT4	<input type="checkbox"/> <input type="checkbox"/> <input type="checkbox"/> <input type="checkbox"/>	Digital Dual Timer
Settings	P	Preset method
Display digits	4	4 digit display (9999)
Control output	2	2-stage output
External connection	A	11-pin socket type
	B	8-pin socket type

Temperature Controllers
Recorders
Digital Counter/ Timers
Analog Timers
Multi Pulse Meters
Panel Meters
Peripheral Devices
Proximity Sensors
Photo Sensors
Rotary Encoders
Thyristor Power Regulators
Solid State Relays
Power Supplies
Control Switches / Combination
Display Lights
Power / Main / Cam Switches
Limit Switches
Micro Switches
Foot / Mono Lever / Pendant Switches
Signal Lights
Power Buzzers / Terminal Blocks
Fuse Holders / Control Boxes

Digital Counter / Timers

TF4 Digital Timers

Specifications

Model		TF4-A	TF4-B	TF4-C
Appearance				
W×H×D (mm)		48.0×48.0×72.0		
Input	Reset	Power reset (min. 500 ms), external reset and manual reset (min. 20 ms)		
	Inhibit input	Measurement time stop by external signal (min. 20 ms)		
	Noise immunity	Square wave noise by noise simulator (1μs pulse width), ± 2 kV (between operation power terminals)		
Performance	Repetition accuracy	Max. ±0.01 % ±0.05 sec of set value (when the power is START) Max. ±0.005 % ±0.003 sec of set value (if start by reset)		
	Insulation resistance	Min. 100 MΩ (500 V d.c.) conductive terminal - unfilled metal		
	Dielectric strength	2000 V a.c. 60 Hz for 1 min (different live part terminals)		
Function and output	Operation type	Up display, down display (selection by suffix code)		
	Output operation	Present value becomes "ON" when the set value is matched (addition) Present value becomes "ON" when it becomes "0" from the set value (subtraction) ※ refer to output operating mode		
	Time setting recognition	Constant recognition (setting can be changed even during energization)		
	Character display	Height 11 mm, width 8 mm		
	Control output	Relay	Time limit 1 c, 250 V a.c. 3 A (resistive load)	
	Transistor	Open collector, max. 30 V d.c. 100 mA`		
	Time range	A: 999.9 sec / 9999 sec, B: 9 min 59.9 sec / 59 min 59 sec, C: 999.9 min / 59 hours 59 min		
Power voltage		<ul style="list-style-type: none"> ● 100 - 240 V a.c. 50/60 Hz, ● 24 - 60 V d.c. 		
Voltage fluctuation rate		±10% of power voltage		
Power consumption		<ul style="list-style-type: none"> ● AC: approx. 4.8 VA (240 V a.c. 60 Hz), ● DC: approx. 0.7 W (24 V d.c.) 		
Ambient temperature & humidity		-10 ~ 50 °C 35 ~ 85 % RH (without condensation)		
Storage temperature		-20 ~ 65 °C		
Vibration resistance		10 - 55 Hz, single amplitude 0.5 mm, 3 axes each direction, 2 h		
Shock resistance		300 m/s, 3 axes each direction each 3 times		
Weight		Approx. 100 g		

Suffix code

Model	Code	Content
TF4-	<input type="checkbox"/> <input type="checkbox"/> <input type="checkbox"/> <input type="checkbox"/>	Digital Timer 48(W) X 48(H)
Time Specifications	A	999.9 sec / 9999 sec
	B	9 min 59.9 sec / 59 min 59 sec
	C	999.9 min / 59 hours 59 min
Display method	U	Up display
	D	Down display
Power voltage	A	100 - 240 V a.c. 50/60 Hz
	D	24 - 60 V d.c.
Control output	R	Relay
	T	Open collector

LF4N series LCD Timers

Specifications

Model		LF4N-A	LF4N-B	LF4N-C	LF4N-D
Appearance					
W×H×D (mm)		48.0×48.0×69.5			
Input	Input signal	Reset, start, inhibit. ※LF4N-A and LF4N-D only.			
	Non-voltage input	Paragraph level (during transistor ON): residual voltage max. 0.7 V d.c., impedance max. 2 kΩ			
		Open level (during transistor OFF): impedance min. 100 kΩ			
Contact input	Use a contact that can open and close 5 V d.c., 2 μA sufficiently				
Performance	Repetition accuracy	Max. ±0.01 % ±0.05 s of set value (power start), max. ±0.005 % ±0.03 s of set value (start signal)			
	Return time	Max. 0.1 s			
	Noise immunity	Square wave noise by noise simulator (1 μs pulse width), ±2 kV (between operation power terminals)			
	Insulation resistance	Min. 100 MΩ (500 V d.c.) conductive terminal - unfilled metal			
	Dielectric strength	2000 V a.c. 60 Hz for 1 min (different live part terminals)			
Function and output	Output operation mode	Operating mode 10 types (selection by front digital switch) but LF4N-B, LF4N-C (A mode: POWER ON delay fixed)			
	Time display method	Set by internal UP / Down selection switch			
	Time range	Time range 10 types (selection by front digital switch)			
	Set value recognition	Constant recognition (setting can be changed even during energization)			
	Control output	SPDT (1c), 250 V a.c. 3A, resistive load			
		Time limit 1c	Time limit 1c, instantaneous 1c	Time limit 1c × 2	Time limit 1c
Applicable socket	8-pin socket			11-pin socket	
Power voltage		24 - 240 V a.c./d.c. 50/60 Hz			
Voltage fluctuation rate		±10% of power voltage			
Power consumption	240 V a.c.	Approx. 2.5 VA	Approx. 2.9 VA		Approx. 2.5 VA
	240 V d.c.	Approx. 1.5 W	Approx. 2.1 W		Approx. 1.5 W
Ambient temperature & humidity		-10 ~ 55 °C, 35 ~ 85 % RH (without condensation)			
Storage temperature		-20 ~ 65 °C			
Vibration resistance		10 - 55 Hz, double amplitude 0.75 mm, 3 axes each direction, 2 h			
Shock resistance		300 m/s, 3 axes each direction each 3 times			
Weight		Approx. 110 g			



Suffix code

Model	Code	Content		
LF4N-	□	LCD Timer		
Types selection	A	Time limit 1c	Operating mode (10 types)	8-pin socket type
	B	Time limit 1c, instantaneous 1c	ON delay output (A mode fixed)	
	C	Time limit 2c		Operating mode (10 types)
	D	Time limit 1c	11-pin socket type	
Power voltage	24 - 240 V a.c./d.c. 50/60 Hz			

Digital Counter / Timers

LY series Weekly & Yearly Time Switches

Specifications

Model		LY4	LY7
Appearance			
W×H×D (mm)		48.0×48.0×59.8	72.0×72.0×56.0
Power voltage		100 - 240 V a.c. 50/60 Hz	
Allowable voltage fluctuation rate		±10 % of power voltage	
Power consumption		Approx. 2.6 VA (220 V a.c. 60 Hz)	Approx. 4.2 VA (220 V a.c. 60 Hz)
Display method		LCD Display method (display digits: 4 digits 2 lines) 1st display: character height 7.8 mm, 2nd display: character height 5.2 mm	LCD Display method (Display digits: 4 digits 2 lines) 1st display: character height 12 mm, 2nd display: character height 7 mm
1 cycle time		During weekly setting: 1 week (7 days), yearly setting: for 1 year (calendar until 2099 built-in)	
Power outage compensation time		More than 5 consecutive years (25°C)	
Setting steps	Number of program steps	Weekly program: 64 steps, yearly program: 32 steps	
	Number of season settings	4 seasons (spring, summer, fall, winter)	
	Number of holiday settings	16 times	
Installation structure (external connection)		Flush panel mount type, and exposed panel mount type (dual usage) Din rail installation and screw fixing	
Cycle error		±15 sec/month (25°C)	
Time error		±0.01% max. ±0.05 sec (setting error, voltage error, temperature error)	
Control output	Contact configuration	OUT: SPST (1a)	2 independent circuits. OUT1 : SPDT (1c), OUT2 : SPDT (1c)
	Contact capacity	15 A 250 V a.c. (resistive load)	
	Mechanical life	Min. 10 million times	
	Electrical life	Min. 50,000 times (250 V a.c. 15 A resistive load)	
Insulation Resistance		Min. 100 MΩ (500 V d.c. Mega standard, conductive terminal - exposed unfilled metal part)	
Dielectric strength		2000 V a.c. 50/60 Hz for 1 min (conductive terminal - exposed unfilled metal part)	
Noise immunity		±2 kV (among operation power terminals), square wave noise by noise simulator (pulse width= 1 μs)	
Vibration resistance		10 - 55 Hz (1 minute cycle) double amplitude 0.75 mm X·Y·Z each direction 1 hour	
Shock resistance		300 m/s ² X·Y·Z each direction 3 times	
Ambient temperature & humidity		-10 ~ 55 °C, 35 ~ 85 % RH (without condensation)	
Storage temperature		-20 ~ 65 °C	
Weight		Approx. 100 g (box excluded)	Approx. 275 g (box excluded)

Suffix code

Model	Code	Content
LY-	<input type="checkbox"/>	LCD Weekly, Yearly Time Switch
Appearance	4	48(W) X 48(H) mm
	7	72(W) X 72(H) mm
Power voltage		100 - 240 V a.c 50/60 Hz

T21 Timing Relays

Specifications

Model	AC	T21 - 1 / 3 / 6 / 3H - 4A20
	DC	T21 - 1 / 3 / 6 / 3H - 4D24
Appearance		
Power voltage	AC	200 - 230 V a.c. 50/60 Hz
	DC	24 V d.c.
Allowable voltage fluctuation rate		±10% of power voltage
Power consumption	AC	Max. 3.1 VA (230 V a.c. 60 Hz)
	DC	Max. 1.5 W (24 V d.c.)
Return time		Max. 100 ms
Time range	1	0.1 sec ~ 10 min
	3	0.3 sec ~ 30 min
	6	0.6 sec ~ 60 min
	3H	0.3 hrs ~ 24 hrs
Time error (Repetition error)		±1 % max. (ratio of maximum scale)
Time error (Setting error)		±10 % max. (ratio of maximum scale)
Control output	Operation mode	Power ON delay, interval, flicker OFF start, flicker ON start
	Contact configuration	4a4b
	Contact capacity	240 V a.c. 3A resistive load
Relay life		Mechanical life: min. 10 million times, Electrical life: min. 100,000 times
Insulation resistance		Min. 100 MΩ (500 V d.c. standard, conductive terminal - exposed unfilled metal part)
Dielectric strength		2000 V a.c. 50/60 Hz for 1 min (conductive terminal - exposed unfilled metal part)
Noise immunity		±2 kV (among operation power terminals, Pulse width ±1 μs, square wave noise by noise simulator)
Vibration resistance		10 - 55 Hz (for 1 min) double amplitude 0.75 mm X·Y·Z each direction 1 hour
Shock resistance		300 m/s ² X·Y·Z each direction 3 times
Ambient temperature & humidity		- 10 ~ 50 °C, 35 ~ 85 % RH (without condensation)
Storage temperature		- 25 ~ 65 °C
Weight		Approx. 42 g

Suffix code

Model	Code	Content
T21-	<input type="checkbox"/> <input type="checkbox"/> <input type="checkbox"/>	Timing Relay
Time range	1	1 sec, 10 sec, 1 min, 10 min
	3	3 sec, 30 sec, 3 min, 30 min
	6	6 sec, 60 sec, 6 min, 60 min
	3H	3 hrs, 6 hrs, 12 hrs, 24 hrs
Contact configuration	4	4a4b
Power voltage	A20	200 - 230 V a.c.
	D24	24 V d.c.
	A10	100 - 120 V a.c.

Temperature Controllers

Recorders

Digital Counter/ Timers

Analog Timers

Multi Pulse Meters

Panel Meters

Peripheral Devices

Proximity Sensors

Photo Sensors

Rotary Encoders

Thyristor Power Regulators

Solid State Relays

Power Supplies

Control Switches Combination Display Lights

Power / Main / Cam Switches

Limit Switches

Micro Switches

Foot / Mono Lever / Pendant Switches



Signal Lights

Power Buzzers / Terminal Blocks Fuse Holders / Control Boxes

Analog Timers

■ T38N, T48N, T57N ON-Delay Timers

Specifications

Model	Exposed type	T38N	T48N	T57NE
	Panel type			T57NP
Appearance				
W×H×D (mm)		40.5×50.5×74.0	48.0×48.0×78.7	<ul style="list-style-type: none"> Exposed type: 50.0×70.0×86.2 Panel type: 57.5×84.4×83.7
Functions		Power On Delay Timer		
Power voltage		24 - 240 V a.c. 50/60 Hz, 24 - 240 V d.c., 12 V d.c. (order-made for T48N)		
Voltage fluctuation rate		±10 % of power voltage		
Power consumption		<ul style="list-style-type: none"> ● Max. approx. 4.5 VA (240 V a.c. 60 Hz) ● Max. approx. 1.5 W (24 V d.c.) 		
Return time		Max. 100 ms		
Time range	01	0.01 ~ 1 s / 0.01 ~ 1 m / 0.01 ~ 1 h		
	03	0.01 ~ 3 s / 0.01 ~ 3 m / 0.01 ~ 3 h		
	06	0.01 ~ 6 s / 0.01 ~ 6 m / 0.01 ~ 6 h		
	10	0.01 ~ 10 s / 0.01 ~ 10 m / 0.01 ~ 10 h		
	30	0.01 ~ 30 s / 0.01 ~ 30 m / 0.01 ~ 30 h		
	60	0.01 ~ 60 s / 0.01 ~ 60 m / 0.01 ~ 60 h		
	12H	0.01 ~ 12 h / 0.01 ~ 24 h / 0.01 ~ 48 h ('24h' and '48h' time setting '12h' : 'x2' and 'x4')		
Time error	Repeating error	Max. ±0.3 % (ratio of maximum scale)		
	Setting error	Max. ±5 % (ratio of maximum scale)		
Control output	Output mode	POWER ON DELAY		
	Contact configuration	A output (time limit 1c + instantaneous 1a) / B output (time limit 1c + instantaneous 1c) / C output (time limit 2c)		
	Contact capacity	250 V a.c. 3 A (resistive load)		
Relay life		Mechanical life: min. 10 million times, electrical life: min. 100,000 times		
Dielectric strength		2000 V a.c. 50/60 Hz for 1 min		
Noise immunity		±2 kV (among operation power terminals), square wave noise by noise simulator (pulse width: 1 μs)		
Insulation resistance		Min. 100 MΩ (500 V d.c. Mega standard)		
Vibration resistance		10 - 55 Hz (for 1 min) double amplitude 0.5 mm X·Y·Z each direction 2 hours		
Shock resistance		300 m/s ² (30 G) X·Y·Z each direction 3 times		
Ambient temperature & humidity		-10 ~ 55 °C, 30 ~ 85 % RH (without condensation)		
Storage temperature		-25 ~ 65 °C		



Suffix code

Model	Code	Content
Appearance	<input type="checkbox"/> - <input type="checkbox"/> <input type="checkbox"/> <input type="checkbox"/> <input type="checkbox"/> <input type="checkbox"/> <input type="checkbox"/>	Analog Timer
	T38N	40(W) X 50(H) mm
	T48N	48(W) X 48(H) mm
	T57N	58(W) X 84(H) mm
Installation structure	P	Panel type (T38N panel adapter sold separately)
	E	Exposed type (select with T48N panel type)
Range (dip switch selection)	01	1 sec, 1 min, 1 hour
	03	3 sec, 3 min, 3 hour
	06	6 sec, 6 min, 6 hour
	10	10 sec, 10 min, 10 hour
	30	30 sec, 30 min, 30 hour
	60	60 sec, 60 min, 60 hour
	12	12 hour, 24 hour, 48 hour
Control output	A	Time limit: 1c contact, instantaneous: 1a contact
	B	Time limit: 1c contact, instantaneous: 1c contact
	C	Time limit 2c contact
Power voltage		24 - 240 V a.c./d.c. (common) 50/60 Hz
	12	12 V d.c. (only for T48N, order-made)
Output operation		On-Delay
	S	Interval (order-made)

※ The installation type is only applied to the T57N, TF62N and TF62D (T38N model requires the separate purchase of panel adapter)

TF62N, TF62D Twin / Dual Timers

Specifications

Model	Exposed type	TF62NE	TF62DE
	Panel type	TF62NP	TF62DP
Appearance			
W×H×D (mm)	<ul style="list-style-type: none"> Exposed type: 50.0×62.0×91.2 Panel type: 57.5×84.5×83.7 		<ul style="list-style-type: none"> Exposed type: 50.0×77.0×91.2 Panel type: 57.5×84.4×83.7
Functions	Twin timer		Dual timer
Power voltage	24 - 240 V a.c. 50/60 Hz, 24 - 240 V d.c.		
Voltage fluctuation rate	±10 % of power voltage		
Power consumption	<ul style="list-style-type: none"> Max. approx. 4.5 VA (240 V a.c. 60 Hz) Max. approx. 1.5 W (24 V d.c.) 		
Return time	Max. 100 ms		
Time range	01	0.01 ~ 1 s / 0.01 ~ 1 m / 0.01 ~ 1 h	
	03	0.01 ~ 3 s / 0.01 ~ 3 m / 0.01 ~ 3 h	
	06	0.01 ~ 6 s / 0.01 ~ 6 m / 0.01 ~ 6 h	
	10	0.01 ~ 10 s / 0.01 ~ 10 m / 0.01 ~ 10 h	
	30	0.01 ~ 30 s / 0.01 ~ 30 m / 0.01 ~ 30 h	
	60	0.01 ~ 60 s / 0.01 ~ 60 m / 0.01 ~ 60 h	
Time error	Repeating error	Max. ±0.3 % (ratio of maximum scale)	
	Setting error	Max. ±5 % (ratio of maximum scale)	
Control output	Output mode	FLICKER (ON Start)	FLICKER (ON-A Start)
	Contact configuration	D type (time limit 1c)	F type (time limit 2c)
	Contact capacity	250 V a.c. 3 A (resistive load)	
Relay life	Mechanical life: min. 10 million times, electrical life: min. 100,000 times		
Dielectric strength	2000 V a.c. 60 Hz for 1 min		
Noise immunity	±2 kV (among operation power terminals), square wave noise by noise simulator (pulse width:1 μs)		
Insulation resistance	Min. 100 MΩ (500 V d.c. Mega standard)		
Vibration resistance	10 - 55 Hz (for 1 min) single amplitude 0.5 mm X·Y·Z each direction 2 hours		
Shock resistance	300 m/s ² (30 G) X·Y·Z each direction 3 times		
Storage temperature	-25 ~ 65 °C		
Ambient temperature & humidity	-10 ~ 55 °C, 30 ~ 85 % RH (without condensation)		

Suffix code

Model	Code	Content
Appearance	<input type="checkbox"/> - <input type="checkbox"/> <input type="checkbox"/> <input type="checkbox"/> <input type="checkbox"/> <input type="checkbox"/>	Analog Timer
	TF62N	Twin timer 58(W) X 84(H) mm
	TF62D	Dual timer 58(W) X 84(H) mm
Installation structure	P	Panel type
	E	Exposed type
Range (dip switch selection)	01	1 sec, 1 min, 1 hour
	03	3 sec, 3 min, 3 hour
	06	6 sec, 6 min, 6 hour
	10	10 sec, 10 min, 10 hour
	30	30 sec, 30 min, 30 hour
	60	60 sec, 60 min, 60 hour
Control output	D	TF62N Twin timer fixed code
	F	TF62D Dual timer fixed code
Power voltage		24 - 240 V a.c./d.c. (common) 50/60 Hz
	12	12 V d.c. (only for T48N, order-made)

※ Installation type selection is only applied to the model T57N, TF62N and TF62D (Model T38N requires separate purchase of panel adapter)

Analog Timers

MA4N series Analog Multi Timers

Specifications

Model	MA4N-A	MA4N-B	MA4N-C
Appearance			
W X H X D (mm)	48.0×48.0×61.3		
Power voltage	24 - 240 V a.c. / d.c. 50/60 Hz		
Voltage fluctuation rate	±10 % of power voltage		
Power consumption	● 5.3 VA (240 V a.c.) ● 2.5 W (240 V d.c.)		
Return time	Max. 0.1 sec		
Min signal width	START input, INHIBIT input, RESET input: min. 20 ms		-
Input	Non-voltage input Impedance during short circuit: max. 2 kΩ Residual voltage during short circuit: max. 0.7 V d.c. Impedance during open: min. 100 kΩ		-
Output	Time limit 2c	Time limit 1c, instantaneous 1c	Time limit 2c, time limit 1c + instantaneous 1c
	● NO: 10 A 125 V a.c., 5 A 250 V a.c., 5 A 30 V d.c. ● NC: 3 A 125 V a.c., 2 A 250 V a.c., 1 A 30 V d.c.		
Repeating error	Max. ±0.3 %		
Setting error	Max. ±5 % ±0.05 sec		
Temperature error	Max. ±2 %		
Insulation resistance	Min. 100 MΩ (500 V d.c. mega standard)		
Dielectric strength	2000 V a.c. at 50/60 Hz for 1 min		
Impulse voltage	Max. ±2000 V		
Vibration resistance	10 - 55 Hz double amplitude 0.75 mm		
Shock resistance	300 m/s ² (approx. 30 G)		
Life	Mechanical	Min. 10 million times (switching frequency 180 times / min)	
	Electrical	More than 100 thousand times (250 V a.c. 3 A resistive load)	
Terminal structure	Plug 11-pin		Plug 8-pin
Ambient temperature & humidity	-10 ~ 55 °C, 35 ~ 85 % RH (without condensation)		
Storage temperature	-20 ~ 65 °C		
Weight	Approx. 100 g (fixtures included)		

Suffix code

Model	Code	Content
MA4N-	<input type="checkbox"/>	Analog Multi Timer
Type	A	Time limit 2c ※ 11-pin type
	B	Time limit 1c + instantaneous 1c ※ 11-pin type
	C	Time limit 2c, time limit 1c + instantaneous 1c ※ by mode selection (8-pin type)
Power voltage	24 - 240 V a.c./d.c. (50/60 Hz)	

MA4SD series Star-Delta Timers

Specifications

Model		MA4SD	MA4SDI
Appearance			
W X H X D (mm)		48.0×48.0×61.3	
Power voltage		100 - 240 V a.c. 50/60 Hz, 24 - 240 V d.c. dual usage	
Allowable voltage fluctuation rate		±10 % of power voltage	
Power consumption		<ul style="list-style-type: none"> ● Approx. 3.8 VA (100 - 240 V a.c. 60 Hz) ● Approx. 1.9 W (24 - 240 V d.c.) 	
Return time		Max. 100 ms	
Operating time range		1 ~ 300 sec	
λ Operating time error		<ul style="list-style-type: none"> ● Repetition error: max. ±0.3 % ● Setting error: max. ±5 % ● Voltage error: max. ±0.5 % ● Temperature tolerance: max. ±2 % (ratio of maximum scale) 	
Δ Conversion time error		Max. ±25 %	
Control output	Operation mode	Power ON Start	
	Contact configuration	λ Contacts: 1a, ΔContacts: 1a	λ Contacts: 1a, Δcontacts: 1a, instantaneous contacts: 1a
	Contact capacity	250 V a.c. 5 A resistive load	
Relay life		<ul style="list-style-type: none"> ● Mechanical: min. 5 million times ● Electrical: min. 100,000 times (250 V a.c. 5 A resistive load) 	
Insulation resistance		Min. 100 MΩ (500 V d.c. Mega standard, conductive terminal - exposed unfilled metal part)	
Dielectric strength		2000 V a.c. 50/60 Hz for 2 min (conductive terminal - exposed unfilled metal part)	
Noise immunity		±2 kV (among operation power terminals, pulse width ±1 μs, square wave noise by noise simulator)	
Vibration resistance		10 - 55 Hz (for 1 min), double amplitude 0.75 mm X·Y·Z each direction 1 hour	
Shock resistance		300 m/s ² (30G) X·Y·Z each direction 3 times	
Ambient temperature & humidity		-10 ~ 55 °C, 35 ~ 85 % RH (without condensation)	
Storage temperature		-25 ~ 65 °C	
Weight		Approx. 95 g (fixtures included)	

Suffix code

Model	Code	Content
MA4	□	Analog Multi Timer (Star-Delta Timer), 48 (W) × 48 (H) mm
Control output	SD	λ (Star) output, Δ(Delta) output
	SDI	Instantaneous output, λ(Star) output, Δ(Delta) output

- Temperature Controllers
- Recorders
- Digital Counter/ Timers
- Analog Timers
- Multi Pulse Meters
- Panel Meters
- Peripheral Devices
- Proximity Sensors
- Photo Sensors
- Rotary Encoders
- Thyristor Power Regulators
- Solid State Relays
- Power Supplies
- Control Switches Combination Display Lights
- Power / Main / Cam Switches
- Limit Switches
- Micro Switches
- Foot / Mono Lever / Pendant Switches
- Signal Lights
- Power Buzzers / Terminal Blocks Fuse Holders / Control Boxes

Multi Pulse Meters

BP series Multi Pulse Meters

Specifications





Model		BP6	
Appearance			
W X H X D (mm)		72.0×36.0×100.0	
Input	Contactless input	Max. 50 KHz (duty ratio 50 %, each min. 10 μs) (ON voltage 4.5 V - 24 V, OFF voltage 0 - 1.0 V)	
	Contact input	30 Hz max. (duty ratio 50 %, each min. 16.6 ms) (12 V d.c., can open and close enough current of 2 mA)	
	Max. display digits	5 digits (0 ~ 99999)	
	Display cycle	0.05 sec, 0.5 sec, 1 sec, 2 sec, 4 sec, 8 sec	
	Measuring range		Number of revolutions / frequency / speed (F1), absolute ratio (F10), error ratio (F11), density (F12), error (F13): 0.0005 Hz - 50 KHz
			Moving speed (F2): 0.003 Hz - 1000 Hz
		Cycle (F3), transit time (F4), time difference (F5), time width(F6): 0.001 s - 3,200 s Pulse width(F7), pulse interval (F8), integration counter (F9): 0 - 4 X 10 ⁹ Count	
Performance	Measuring accuracy	±0.05 % rdg ±1 dig (mode F1, F4, F10, F11, F12, F13), ±0.01 % rdg ±1 dig (mode F2, F3, F5, F6)	
	Life (Mechanical)	20 million times	
	Life (Electrical)	100,000 times when opening and closing 250 V a.c. 3 A (30 V d.c. 3 A), 50,000 times when opening and closing 250 V a.c. 5 A (30 V d.c. 5 A) Opening / closing speed is 20 times per minute	
	Noise immunity	±2000 V Square wave noise by noise simulator (pulse width 1μs)	
	Insulation resistance	10 MΩ min (500 V d.c., between live part - unfilled part)	
	Dielectric strength	2000 V a.c. 60 Hz for 1 min (between power terminal - case, power terminal - input terminal)	
Functions	Display method	7 segment LED	
	Character size (mm)	7.6 X 13.8 (W X H mm)	
	Operation mode	Number of revolutions, frequency, speed (F1), moving speed (F2), cycle (F3), transit time (F4), time difference (F5), time width (F6), pulse width (F7), pulse interval (F8), integration counter (F9), absolute ratio (F10), error ratio(F11), density(F12), error (F13)	
	Prescale	0.0001 X 10 ⁻⁹ ~ 9.9999 X 10 ⁹	
	Hysteresis	0 ~ 9999 (only output type applied, setting range varies with mode)	
	Other features	<ul style="list-style-type: none"> ● Time unit selection function ● Start compensation timer function ● Display cycle setting function ● Parameter lock function ● Auto zero time setting function, ● Power outage compensation function (F9 only) ● 4 measured values ● Minimum measurement average value ● 4 max. measured values ● Max. measured average value storage function (10 types) ● Comparative output function (HH, H, GO, L, LL) 	
Output	Comparison alarm output	NPN open collector (HH, H, GO, L, LL), (12 - 24 V d.c. max. 100 mA)	
		Relay 3 stages (H, GO, L)	
Power voltage		AC voltage (AC): 100 - 240 V a.c. 50/60 Hz DC voltage (DC):24 - 60 V a.c. / d.c. 50/60 Hz	
Voltage fluctuation rate		±10 % of power voltage	
Power consumption		Approx. 10 VA	
Sensor power		12 V d.c. ±10 %, max. 120 mA	
Vibration resistance		10 - 55 Hz double amplitude 0.75 mm X·Y·Z each direction 2 hours	
Shock resistance		300 m/s ² (30 G) X·Y·Z each direction 3 times	
Ambient temperature & humidity		-10 ~ 50 °C, 35 ~ 85 % RH (without condensation)	
Storage temperature		-20 ~ 60 °C	
Weight		Approx. 135 g	

Suffix code

Model	Code	Content
BP	□ - □ □ □ □	Multi Pulse Meter
Appearance	6	72(W) X 36(H) mm
Display digits	5	5 digits (-19999 - 99999)
Power voltage	A	100 - 240 V a.c. 50/60 Hz
	D	24 - 60 V a.c. / d.c.
Output specifications	N	Display only
	1	Relay 3 stages output

RP series Multi Pulse Meters

Specifications

Model	RP7	RP3	RP4	RP6	RP1	
Appearance						
W X H X D (mm)	72.0×72.0×87.0	96.0×48.0×100.0	48.0×48.0×79.3	72.0×36.0×100.0	48.0×24.0×100.0	
Input	Contactless input	Max. 10 KHz (duty ratio 50 %, each 50 μs min) (ON voltage: 4.5 V - 24 V, OFF voltage: 0 - 1.0 V)				
	Contact input	30 Hz max. (duty ratio 50 %, each min. 16.6 ms) (it should be able to open and close enough current of 12 V d.c. 2 mA)				
	Max. display digits	5 digits (0 ~ 99999), 4 digits (0 ~ 9999)				
	Display cycle	0.05 sec, 0.5 sec, 1 sec, 2 sec, 4 sec, 8 sec				
Performance	Measuring range	<ul style="list-style-type: none"> ● Moving speed (F2): 0.003 Hz ~ 1000 Hz ● Cycle (F3), transit time (F4), time difference (F5), time width(F6): 0.001 s ~ 3,200 s ● Number of revolutions / frequency / speed (F1): 0.0003 Hz ~ 10 KHz ● Pulse width(F7), pulse interval (F8), integration counter (F9): 0 ~ 4 X 10⁹ count 				
	Measuring accuracy	±0.02 % rdg ±1 dig (mode F1, F2, F3, F4, F5), ±0.1 % rdg ±1 dig (mode F6)				
	Life (mechanical)	20 million times				
	Life (electrical)	<ul style="list-style-type: none"> ● 100,000 times when opening and closing 250 V a.c. 3 A (30 V d.c. 3 A) ● 50,000 times when opening and closing 250 V a.c. 5 A (30 V d.c. 5 A). Opening / closing speed is 20 times per minute 				
	Noise immunity	±2000 V square wave noise by noise simulator (pulse width 1 μs)				
	Insulation Resistance	10 MΩ min (500 V d.c., between live part - unfilled part)				
Functions	Dielectric strength	2000 V a.c. 60 Hz for 1 min (between power terminal - case, power terminal - input terminal)				
	Display method	7 Segment LED				
	Operating mode	Number of revolutions / frequency / speed (F1), moving speed (F2), cycle (F3), transit time (F4), time difference (F5), time width (F6), pulse width (F7), pulse interval (F8), integration counter (F9)				
	Prescale	0.0001 X 10 ⁻⁹ ~ 9.9999 X 10 ⁹ RP1: 0.001 X 10 ⁻⁹ ~ 9.999 X 10 ⁹				
Output	Hysteresis	0 ~ 9999 (only output type applied, setting range varies with mode)				
	Other features	<ul style="list-style-type: none"> ● Time unit selection function ● Start compensation timer function ● Display cycle setting function ● Parameter lock function ● Auto zero time setting function ● Power outage compensation function (F9 only) ● 4 measured values ● Minimum measurement average value ● 4 max. measured values ● Max. measured average value storage function (10 types) ● Comparative output function (HH, H, GO, L, LL) ● Current output range selection function (only current output type) 				
Power voltage	Comparison alarm output	● NPN open collector (HH, H, GO, L, LL) (12 - 24 V d.c. max. 100 mA) ● Relay (HH, H, GO, L, LL) (5 A 250 V a.c.)				
	Retransmission output (display value)	4 - 20 mA d.c. (load resistance max. 600 Ω)				
Power consumption	AC	100 - 240 V a.c. 50/60 Hz				
	DC	24 - 60 V a.c. / d.c. 50/60 Hz				
Voltage fluctuation rate		±10 % of power voltage				
Power consumption	AC	Approx. 9.5 VA	Approx. 9.5 VA	Approx. 12 VA	Approx. 12 VA	Approx. 10 VA
	DC	Approx. 5 W	Approx. 5 W	Approx. 6 W	Approx. 5 W	-
Sensor power		12 V d.c. ±10 %, max. 120 mA.				
Vibration resistance		10 - 55 Hz double amplitude 0.75 mm X·Y·Z each direction 2 hours				
Shock resistance		300 m/s ² X·Y·Z each direction 3 times				
Ambient temperature & humidity		-10 ~ 50 °C, 35 ~ 85 % RH (without condensation)				
Storage temperature		-20 ~ 60 °C				
Weight		Approx. 225 g	Approx. 230 g	Approx. 115 g	Approx. 160 g	Approx. 115 g

Suffix code

Model	Code	Content	
RP	<input type="checkbox"/> - <input type="checkbox"/> <input type="checkbox"/> <input type="checkbox"/> <input type="checkbox"/>	Multi Pulse Meter	
Appearance	1	48 (W) × 24 (H) mm	
	3	96 (W) × 48 (H) mm	
	4	48 (W) × 48 (H) mm	
	6	72 (W) × 36 (H) mm	
	7	72 (W) × 72 (H) mm	
Display digits	4	4 digits 1 stage (0 - 9999) ※ Only RP1	
	5	5 digits 1 stage (0 - 99999)	
Power specifications	A	100 - 240 V a.c. 50/60 Hz	
	D	24 - 60 V a.c. / d.c. ※ RP1 excluded	
Output specifications	RP1	H	Display only
		1	Relay 1 stage (H : high limit output)
	RP3	N	Display only
		1	Relay 3 stages (H, GO, L)
		2	Relay 5 stages (HH, H, GO, L, LL)
	RP4	4	NPN open collector 5 stages, 4 - 20 mA d.c. (retransmission output)
		N	Display only
	RP6	1	Relay 1 stage (H : high limit output)
		N	Display only
	RP7	1	Relay 3 stages (H, GO, L)
		3	NPN open collector 5 stages, 4 - 20 mA d.c. (retransmission output)
N		Display only	
5		NPN open collector 5 stages, 4 - 20 mA d.c. (Retransmission output)	

Multi Pulse Meters

■ LP3 series LCD Multi Pulse Meters

Specifications

Model		LP3-5A5	LP3-5A3	LP3-5AN
Appearance				
WXHxD (mm)		96.0×48.0×71.1		
Power voltage		100 - 240 V a.c. 50/60 Hz		
Power consumption		Max. 15 VA	Max. 13 VA	Max. 10 VA
Display method		Negative LCD display		
Character size		PV value (14.5 mm), SV value (10 mm)		
Input frequency		Contactless (max. 50 KHz, ON/OFF pulse width 10 us min), contact (max. 30 Hz, ON/OFF pulse width min. 16.6 ms)		
Input type	Voltage	[H] level (4.5 - 24 V d.c.), [L] level (0 - 1 V d.c.), input impedance (4.5 kΩ)		
	Non-voltage	Impedance during short circuit (max. 300 Ω), residual voltage (1 V max), impedance during open (min. 100 kΩ)		
Measuring range		F1, F2, F10, F11, F12, F13 : 0.0005 ~ 50 KHz, F3, F4, F5, F6 : 0.001 s ~ 3200 s, F7, F8, F9 : 0 ~ 4×10 ⁹		
Measuring accuracy		F1, F4, F10, F11, F12, F13 : FS ±0.05 % rdg ±1 digit, F2, F3, F5, F6 : FS ±0.01 % rdg ±1 digit		
External power supply		12 V d.c. ±10 % 100 mA		
Display cycle		0.05 sec / 0.5 sec / 1 sec / 2 sec / 4 sec / 8 sec		
Display range		-99999 ~ 99999		
Power outage compensation		Approx. 10 years (applying non-volatile EEPROM)		
Control output		HH (SPST), H (SPST), GO (SPST), L (SPST), LL (SPST) * HH/H output COM common, * LL/L output COM common	H (SPDT), GO (SPST), L (SPDT)	-
		NO contact (250 V a.c. 5 A resistive load), NC contact (250 V a.c. 2 A resistive load)		
Relay Life	Electrical	Min. 100 thousand times		
	Mechanical	Min. 10 million times (250 V a.c. 2A)		
Vibration resistance		10 - 55Hz double amplitude 0.75 mm X·Y·Z each direction 2 hours		
Insulation Resistance		Min. 100 MΩ (500 V d.c.), conductive terminal - unfilled metal		
Dielectric strength		2000 V a.c. at 60Hz for 1 min (different live part terminals)		
Noise immunity		±2000 V (pulse width 1 μs, apply square wave noise by noise simulator among power terminals)		
Degree of protection		IP66 (IEC 60529) (product front)		
Ambient temperature & humidity		-10 ~ 50 °C, 35 ~ 85 % RH (without condensation)		
Storage temperature		-20 ~ 60 °C		

Suffix code

Model	Code	Content
LP	□-□□□	LCD Multi Pulse Meter
Appearance	3	96(W) × 48(H) mm
Display digits	5	5-digit display
Power voltage	A	100 - 240 V a.c. 50 - 60Hz
Output specifications	N	Indication only
	3	3-stage setting (H/GO/L)
	5	5-stage setting (HH/H/GO/L/LL)

■ LP1 series LCD Pulse Meters

■ Specifications

Model		LP1	
Appearance			
WXHxD (mm)		48.0×24.0×54.0	
Power voltage		Non-power (battery built-in, changeable)	
Display method		LCD display method, zero blanking	
Battery life		More than approx. 3 years (approx. 25 °C)	
Character size		8.7 mm	
Input type	Voltage input (INB)	● AC voltage input: 3 - 30 V a.c. ● DC voltage input: When High 4.5 - 30 V d.c. When Low 0 - 2 V d.c.	
	Voltage input (INC)	30 - 240 V a.c.	
	Non-voltage input (INA)	● Residual voltage during short circuit: max. 0.5 V, ● Max. impedance during short circuit: max. 10 kΩ, ● Min impedance during open: min. 500 kΩ	
HOLD input method		Non-voltage input	
Measuring range	rpm	1 ~ 10000 rpm	
	0.1 rpm	0.1 ~ 1000.0 rpm	
	rps	1 ~ 1000 rps	
	Hz	1 ~ 1000 Hz	
	0.1 Hz	0.1 ~ 100.0 Hz	
External setting switch		SW1-1 : rps / rpm, SW1-2 : ×1 / ×0.1, SW2-1 : RESET, SW2-2 : (rps, rpm) / Hz	
External connection		Terminal block (5 pins)	
Measuring accuracy		±0.1% rdg ±1 digit	
Vibration resistance		10 - 55 Hz (1 minute cycle) double amplitude 0.75 mm X·Y·Z each direction 1 hour	
Shock resistance		300 m/s ² X·Y·Z each direction 3 times	
Insulation Resistance		Min. 100 MΩ (500 V d.c. Mega standard, conductive terminal - exposed unfilled metal part)	
Dielectric strength		2000 V a.c 50/60 Hz for 1 min (conductive terminal - exposed unfilled metal part)	
Ambient temperature & humidity		-10 ~ 55 °C, 35 ~ 85 % RH (without condensation)	
Storage temperature		-20 ~ 65 °C	
Weight		Approx. 46 g (excluded the weight of the box)	

(note 1) The battery life is calculated based on the above conditions, so please consider them while replacing it

Temperature Controllers
Recorders
Digital Counter/ Timers
Analog Timers
Multi Pulse Meters
Panel Meters
Peripheral Devices
Proximity Sensors
Photo Sensors
Rotary Encoders
Thyristor Power Regulators
Solid State Relays
Power Supplies
Control Switches, Combination Display Lights
Power / Main / Cam Switches
Limit Switches
Micro Switches
Foot / Mono Lever / Pendant Switches
Signal Lights
Power Buzzers / Terminal Blocks Fuse Holders / Control Boxes

Panel Meters

WM3 Digital Wattmeters

Specifications

Model		WM3
Appearance		
WXHxD (mm)		96.0×48.0×102.0
Measuring method		Cycle measurement method
Input voltage		0 - 220 V a.c.
Display cycle		0.1 ~ 2 sec
Power factor		80 ~ 100 %
Response speed		Approx. 2 sec (max. range)
Max. display digits		4 digits (-1999 ~ 9999)
Display		7 segment LED
Accuracy		±0.5 % of FS, ±10 Digit
Insulation resistance		Min. 100 MΩ (500 V d.c.)
Dielectric strength		2000 V a.c. for 1 min (power terminal-input terminal)
Functions	Measurement	AC power (W)
	Average value display	It is difficult to measure the exact value if the change of measured value is severe. In this case, the measured value is averaged by changing the refresh interval. In other words, if parameter mode "ADC" is set to 2, the value is measured and averaged twice and displayed.
	Scale function	High and low measured values for the input signal are changed to arbitrary values and displayed
	Decimal point location setting	Internal selection by parameter
	Hold	The measurement is stopped by the external contact signal (hold) and the present value is maintained immediately before the hold signal.
	Max. / min value display	The max. and min values of the measured value are displayed
	Communication function	RS485 communication
	RMS measurement function	Types of rms computation methods for distorted waveforms
	Decimal position	Select the display position of the decimal point
	Hold function	Memorize the maximum input value or minimum input value or hold (stop) by an external signal.
	Lock function	Limit the setting function of each parameter
	Address	Address is specified when communication function is used
	Communication speed	Set the communication speed (bps)
	Max. value display	The max. value of the measured present value is displayed
	Min value display	The min value of the measured present value is displayed
	High limit setting	Set the high limit set value (HSET) of the high limit output (HI)
	Low limit setting	Set the low limit set value (LSET) of the low limit output (LO).
Output operation (PSOT) selection	If you select "OFF" in output operations (OFF,HH,LH,HL,LL,IL)", there is no output operation. Composed of 5 comparative output modes (Refer to comparative output mode)	
Hysteresis setting	Hysteresis is set to prevent frequent output operation when the measured present value changes slightly near the set value	
Communication output (RS485)	You can set address from 00 to 99 and select the modulation speed of serial retransmission (retransm. speed: 1200, 2400, 4800, 9600, 19200 bps)	
Current output (retransmission)	4 - 20 mA d.c. output for current present value (resolution: 12000)	
Transistor output	PNP / NPN open collector output (12 - 24 V d.c. max. 50 mA)	
Relay output	1 a X 3 contacts (HI, GO, LO), (220 V a.c. 5 A)	
Power voltage	100 - 240 V a.c. 50/60 Hz	
Voltage fluctuation rate	-15 ~ 10 % of power voltage	
Power consumption	Approx. 5 VA	
Ambient temperature & humidity	0 ~ 50 °C, 35 ~ 85 % RH (without condensation)	
Storage temperature	-10 ~ 70 °C	
Vibration resistance	10 - 55 Hz single amplitude X·Y·Z each direction 2 hours	
Shock resistance	300 m/s ² X·Y·Z 6 directions each 3 times	
Weight	300 g	

Suffix code

Model	Code	Content
WM3-	<input type="checkbox"/> <input type="checkbox"/> <input type="checkbox"/>	Digital Wattmeter
Number of phases and wires	1	Single-phase 2-wire (0 - 220 V a.c.)
Input specifications	01	Refer to input specifications (refer to code)
Output (optional)	N	Display only
	0	Relay (HI, GO, LO), 4 - 20 mA d.c.
	1	Relay (HI, GO, LO)
	2	NPN open collector (HI, GO, LO), 4 - 20 mA d.c.
	3	PNP open collector (HI, GO, LO), 4 - 20 mA d.c.
	4	NPN open collector (HI, GO, LO), RS485
	5	PNP open collector (HI, GO, LO), RS485

Input specifications

Code	Content		
01	XXX : 5 A	Universal current transformer	Current transformation rate setting (CT sold separately)
02	XXX : 1 A		Current transformation rate setting (CT sold separately)
03	0 - 2.5 A	Dedicated current transformer (H-1W)	Max. 0 - 500.0 W (CT included)
04	0 - 5 A		Max. 0 - 1100.0 W (CT included)
05	0 - 10 A		Max. 0 - 2200.0 W (CT included)
06	0 - 15 A		Max. 0 - 3300.0 W (CT included)
07	0 - 30 A	Dedicated current transformer (H-2W)	Max. 0 - 6600.0 W (CT included)
08	0 - 50 A		Max. 0 - 11.00 KW (CT included)
09	0 - 80 A	Dedicated current transformer (H-4W)	Max. 0 - 17.60 KW (CT included)
10	0 - 100 A		Max. 0 - 22.00 KW (CT included)
11	0 - 150 A		Max. 0 - 33.00 KW (CT included)
12	0 - 200 A	Dedicated current transformer (H-5W)	Max. 0 - 44.00 KW (CT included)

PF3 Digital Power Factor Meters

Specifications

Model	PF3	
Appearance		
WXHxD (mm)	96.0×48.0×102.6	
Display method	7 Segment LED display	
Output (optional)	Relay	1a X 3 contacts (HI, GO, LO), (220 V a.c. 5A)
	Retransmission	4 - 20 mA d.c. (output for current present value), resolution: 2000
Performance	Measuring method	Cycle measurement method, Cos φ = LEAD 0.1 ~ 1 ~ LAG 0.1
	Display cycle	0.5 ~ 2 sec (Under 5% of the rated current, in the load the operation may be inaccurate or the display cycle may be slowed down)
	Display range	±0.10 - 1.00
	Measurement	Power factor (Cos φ)
	Input voltage	0 - 220 V a.c. 50/60 Hz
	Input current	5 A, 1 A (external current transformer secondary current)
Main functions	Accuracy	2 % (Display range)
	Hold function	Automatic detection of max. and min measured values, hold and external hold
	Control	Display value hold
	Other features	Comparative output (HI,GO,LO) Max. / min value display by front key Set value change protection function Average cycle handling and display cycle delay function Retransmission output (4 - 20 mA d.c. present value)
Power voltage	100 - 240 V a.c. 50/60 Hz (dual usage), allowable voltage fluctuation range: ±10 %	
Power consumption	Approx. 6 VA	
Insulation Resistance	Min. 100 MΩ (500 V d.c. Mega standard) between external terminal and case	
Dielectric strength	Min. 2000 V a.c. for 1 min (between external terminal and case)	
Noise immunity	Square wave noise by noise simulator pulse width 1 μs, ±1000 V	
Vibration resistance	10 - 55 Hz single amplitude 0.75 mm X, Y, Z each direction 2 hours	
Shock resistance	300 m/s, X, Y, Z each direction 3 times	
Ambient temperature & humidity	-10 ~ 55 °C, 35 ~ 85 % RH (without condensation)	
Storage temperature	-20 ~ 65 °C	
Weight	Approx. 300 g	

Suffix code

Model	Code	Content
PF3-	<input type="checkbox"/> <input type="checkbox"/> <input type="checkbox"/>	Digital Power Factor Meter
Phase (Ø) classification	1	Single-phase 2-wire, 0 - 220 V a.c.
Measurement input signal	01	XXX : 5 A (using an universal current transformer)
	02	XXX : 1 A (using an universal current transformer)
Output (optional)	N	Display only
	0	Relay (HI, GO, LO) + Current output (4 - 20 mA)
	1	Relay (HI, GO, LO)

* "-" is displayed for the power factor.

Panel Meters

MP3 series Digital Multimeters

Specifications

Model		MP3	
Appearance		 <p><Front Plate Type> <Front Acrylic Type></p>	
W×H×D (mm)		96.0×48.0×102.6	
Input	Input signal	AC (voltage, current), DC (voltage, current)	
	A / D converter	2-way integral method	
	Sampling cycle	DC type: 100 ms, AC type: 300 ms	
	Response speed	Approx. 0.3 sec (max. range)	
	Max. display digits	4 digits (-1999 ~ 9999)	
	Display	7 segment LED	
Performance	Accuracy	AC: ±0.5 % of FS ±1 Digit, DC: ±0.2 % of FS ±1 Digit	
	Insulation Resistance	Min. 100 MΩ (500 V d.c. mega standard) between external terminal and case	
	Dielectric strength	Min. 2000 V a.c. for 1 min (between external terminal and case)	
Function	Multi Inputrange	Selects the range to measure (refer to measurement input and range)	
	Magnification	The measured value is multiplied by the value set in magnification and displayed	
	Input correction	The measured value is corrected and displayed	
	Refresh interval	It is difficult to measure the exact value if the change of measured value is severe. In this case, it is possible to average the measured value by changing the refresh interval.	
	Start compensation time	Set the measurement delay time for the purpose of removing wrong measured value due to initial overvoltage or overcurrent	
	Scaling function	Function to convert the measurement input high / low limit value to arbitrary numerical value	
	RMS measurement	AC input type root mean square measuring specifications (AVR, AAR) are types of RMS computation methods for distorted waveforms	
	Decimal position	Select the display position of the decimal point	
	Hold function	Memorize the maximum input value or minimum input value or hold (stop) by an external signal.	
	Lock function	Limit the setting function of each parameter	
	Communication address	Address is specified when communication function is used	
	Communication speed	Set the communication speed (bps)	
	Output operation (PSOT) selection	If "OFF" is selected in output operation (OFF, HH, LH, HL, LL, IL), no output operation. 5 comparative output modes (refer to comparative output mode)	
	Hysteresis settings	Hysteresis is set to prevent frequent output operation when the measured present value changes slightly near the set value.	
	Automatic zero indication	Pressing the ∇ + \triangleleft buttons simultaneously in the measuring state (RUN) and pressing the * button executes the auto zero function. When "0" is not displayed due to an error between the input signal and the instrument, "0" is set if this function is executed.	
	Output	CommunicationOutput (RS485)	Addresses can be set from 00 to 99 and the modulation speed of the serial retransmission can be selected. (retransmission speed: 1200, 2400, 4800, 9600, 19200 bps)
		Serial communication	Generate the sign (POL), decimal point (DOT), clock, data, latch signal in order to make the current present value to the programmable controller and process
		Current output (retransmission)	4 - 20 mA d.c. output for current present value (Resolution: 12000)
BCD output		Output current present value in BCD format (D0, D1, D2, D3, POL, DOT, A0, A1, A2, A3)	
Transistor output		PNP / NPN open collector output (12 - 24 V d.c. max. 50 mA)	
Relay output	1 c X 3 contacts (HI, GO, LO), (220 V a.c. 5 A)		
Power voltage	100 - 240 V a.c. 50/60 Hz (allowable voltage fluctuation range: ±10 %), 24 V d.c. (allowable voltage fluctuation range: ±10 %)		
Allowable voltage fluctuation range	85 - 264 V a.c.		
Power consumption	Approx. 5 VA (100 - 240 V a.c.), 5 W (24 V d.c.)		
Ambient temperature & humidity	-10 ~ 55 °C, 35 ~ 85 % RH (without condensation)		
Storage temperature	-20 ~ 65 °C		
Vibration resistance	10 - 55 Hz 0.75 mm X·Y·Z each direction 2 hours		
Shock resistance	300 m/s, X·Y·Z each direction 3 times		
Weight	Approx. 180g		

Suffix code

Model	Code				Content
MP3-	<input type="checkbox"/>	<input type="checkbox"/>	<input type="checkbox"/>	<input type="checkbox"/>	Digital Multi Panel Meter
Display digits	4				4 digits (9999)
Input	AV				AC voltmeter
	AA				AC ammeter
	DV				DC voltmeter
	DA				DC ammeter
	AVR				AC voltmeter(RMS)
	AAR				AC ammeter(RMS)
Output (optional)	N				Display only
	0				Relay (HI, GO, LO), current output (4 - 20 mA d.c.)
	1				Relay (HI, GO, LO)
	2				NPN open collector (HI, GO, LO), BCD output (dynamic)
	3				PNP open collector (HI, GO, LO), BCD output (dynamic)
	4				NPN open collector (HI,GO,LO), current output (4 - 20 mA)
	5				PNP open collector (HI,GO,LO), current output (4 - 20 mA)
	6				NPN open collector (HI, GO, LO), serial output
	7				PNP open collector (HI, GO, LO), serial output
	8				NPN open collector (HI, GO, LO), communication (RS485)
	9				PNP open collector (HI, GO, LO), communication (RS485)
	10				BCD output (static)
11				Relay (HI, GO, LO), RS485 output	
Front part type	A				Front Acrylic Type
	B				Front Plate Type
Power voltage					No display (100 - 240 V a.c. 50/60 Hz)
	C				24 V d.c. (only front plate type available)

※ When measuring DC current of 5A or more, please use a dedicated shunt, so choose a DC voltmeter

Temperature Controllers
Recorders
Digital Counter/ Timers
Analog Timers
Multi Pulse Meters
Panel Meters
Peripheral Devices
Proximity Sensors
Photo Sensors
Rotary Encoders
Thyristor Power Regulators
Solid State Relays
Power Supplies
Control Switches, Combination Display Lights
Power / Main / Cam Switches
Limit Switches
Micro Switches
Foot / Mono Lever / Pendant Switches
Signal Lights
Power Buzzers / Terminal Blocks Fuse Holders / Control Boxes

Panel Meters

MP6 series Digital Multimeters

Specifications

Model		MP6
Appearance		 <p><Front Plate Type> <Front Acrylic Type></p>
W×H×D (mm)		72.0×36.0×100.0
Input	Input signal	AC (voltage, current), DC (voltage, current)
	A / D converter	2-way integral method
	Sampling cycle	DC type: 100 ms, AC type: 300 ms
	Response speed	Approx. 0.3 sec (max. range)
	Max. display digits	4 digits (-1999~9999)
	Display	7 segment LED
Performance	Accuracy	AC: ±0.5 % of FS ±1 Digit, DC: ±0.2 % of FS ±1 Digit
	Insulation Resistance	Min. 100 MΩ (500 V d.c. Mega standard) between external terminal and case
	Dielectric strength	Min. 2000 V a.c. for 1 min (between external terminal and case)
Functions	Multi Inputrange	Selects the range to measure (Refer to measurement input and range)
	Magnification	The measured value is multiplied by the value set in magnification and displayed
	Input correction	The measured value is corrected and displayed
	Refresh interval	It is difficult to measure the exact value if the change of measured value is severe. In this case, it is possible to average the measured value by changing the refresh interval.
	Start compensation time	Set the measurement delay time for the purpose of removing wrong measured value due to initial overvoltage or overcurrent
	Scaling function	Function to convert the measurement input high / low limit value to arbitrary numerical value
	RMS measurement	AC input type root mean square measuring specifications (AVR, AAR) are types of rms computation methods for distorted waveforms
	Decimal position	Select the display position of the decimal point
	Hold function	Memorize the maximum input value or minimum input value or hold (stop) by an external signal.
	Lock function	Limit the setting function of each parameter
	Communication address	Address is specified when communication function is used
	Communication speed	Set the communication speed (bps)
	Output operation (PSOT) selection	If "OFF" is selected in output operation (OFF, HH, LH, HL, LL, IL), no output operation. 5 comparative output modes (refer to comparative output mode)
	Hysteresis settings	Hysteresis is set to prevent frequent output operation when the measured present value changes slightly near the set value
	Automatic zero indication	Pressing the ▽ + ◀ buttons simultaneously in the measuring state (RUN) and pressing the * button executes the auto zero function. When "0" is not displayed due to an error between the input signal and the instrument, "0" is set if this function is executed.
Output	Communication output (RS485)	Addresses can be set from 00 to 99 and the modulation speed of the serial retransmission can be selected. (retransmission speed: 1200, 2400, 4800, 9600, 19200 bps)
	Serial communication	Generate the sign (POL), decimal point (DOT), clock, data, latch signal in order to make the current present value to the programmable controller and process
	Current output (retransmission)	4 - 20 mA d.c. output for current present value (Resolution: 12000)
	BCD output	Output current present value in BCD format (D0, D1, D2, D3, POL, DOT, A0, A1, A2, A3)
	Transistor output	PNP / NPN open collector output (12 - 24 V d.c. max. 50 mA)
	Relay output	1 c X 3 contacts (HI, GO, LO), (220 V a.c. 5 A)
Power voltage	100 - 240 V a.c. 50/60 Hz Allowable voltage fluctuation range: ±10 %, 24 V d.c. Allowable voltage fluctuation range: ±10 %	
Allowable voltage fluctuation range	85 - 264 V a.c.	
Power consumption	Approx. 5 VA (100-240 V a.c.), 5 W (24 V d.c.)	
Ambient temperature & humidity	-10 ~ 55 °C, 35 ~ 85 % RH (without condensation)	
Storage temperature	-20 ~ 65 °C	
Vibration resistance	10 - 55 Hz 0.75 mm X·Y·Z each direction 2 hours	
Shock resistance	300 m/s ² , X·Y·Z each direction 3 times	
Weight	Approx. 180g	

Suffix code

Model	Code	Content
MP6-	<input type="checkbox"/> <input type="checkbox"/> <input type="checkbox"/> <input type="checkbox"/> <input type="checkbox"/>	Digital Multi Panel Meter
Display digits	4	4 digits (9999)
Input	AV	AC voltmeter
	AA	AC ammeter
	DV	DC voltmeter
	DA	DC ammeter
	AVR	AC voltmeter(RMS)
	AAR	AC ammeter(RMS)
Output (optional)	N	Display only
	0	Relay, current output (4 - 20 mA d.c.)
	1	Relay (HI,GO,LO)
	4	NPN open collector , current output (4 - 20 mA)
	5	PNP open collector , current output (4 - 20 mA)
Front part type	A	Front Acrylic Type (100 - 240 V a.c.)
	B	Front Plate Type (100 - 240 V a.c.)
Power voltage		No display (100 - 240 V a.c. 50/60 Hz)
	C	24 V d.c. (only front plate type available)

HLP1 Non-Voltage Digital Scale Meters



Specifications

Model	HLP1		
Appearance			
W X H X D (mm)	48.0×25.5×37.1		
Input	Input specifications	4 - 20 mA d.c.	
	Max. display digits	4 digits (-1999 ~ 9999)	
	Sampling cycle	Selection by parameter (0.5, 1, 2, 3, 4, 5 sec)	
	Input correction	±3 % of FS	
Performance	Accuracy	±0.3 % of FS ±1 Digit	
	Insulation resistance	100 MΩ (500 V d.c.)	
	Dielectric strength	2300 V a.c. 50/60 Hz for 1 min	
Functions		Default set value	Setting range
	High limit scale setting	2000	-1999 ~ 9999
	Low limit scale setting	0400	
	Decimal point setting	00.00	00.00, 000.0, 0000, 0.000
	Display cycle setting	0.5 s	0.5, 1, 2, 3, 4, 5 s
	Error display range setting	5 %	0, 1, 2, 3, 4, 5 %
	High limit correction of display value	0	-199 ~ 199
	Low limit correction of display value	0	
	Measurement delay time setting	0	0 ~ 30 s
	Flashing function setting	OFF	ON, OFF
Parameter lock setting	OFF	ON, OFF	
Power voltage	Non-voltage type		
Ambient temperature & humidity	-5 ~ 50 °C, 20 ~ 90 % RH (without condensation)		
Storage temperature	-25 ~ 70 °C		
Vibration resistance	10 ~ 55 Hz single amplitude X·Y·Z each direction 2 hours		
Shock resistance	300 m/s², X·Y·Z each direction 3 times		

Panel Meters

■ MP3-4H, MP6-4H Digital Frequency Meters

Specifications

Model		MP3-4H	MP6-4H
Appearance			
WXHxD (mm)		96.0×48.0×102.6	72.0×36.0×100.5
Input	Input signal	AC voltage	
	Measuring method	Count measuring method	
	Response speed	Approx. 2 sec (max. range)	
	Max. display digits	4 digits (-1999~9999)	
Performance	Display	7 segment LED	
	Accuracy	Max. ±5 digit	
	Insulation Resistance	Min. 100 MΩ (500 V d.c.)	
Functions	Dielectric strength	2000 V a.c. for 1 min (between input terminal and case)	
	Input range	AC voltage (5 V a.c., 50 V a.c., 500 V a.c.), 0.1 ~ 9999 Hz	
	Input correction	The measured value is corrected and displayed	
	Refresh interval	It is difficult to measure the exact value if the change of measured value is severe. In this case, it is possible to average the measured value by changing the refresh interval.	
	Decimal position	Select the display position of the decimal point	
	Hold function	Memorize the maximum input value or minimum input value or hold (stop) by an external signal.	
	Lock function	Limit the setting function of each parameter	
	Max. value display	The max. value of the measured present value is displayed	
	Min value display	The min value of the measured present value is displayed.	
	High limit setting	Set the high limit set value (HSET) of the high limit output (HI)	
	Low limit setting	Set the lower limit set value (LSET) of the lower limit output (LO).	
	Output operation (PSOT) selection	If "OFF" is selected in output operation (OFF, HH, LH, HL, LL, IL), there is no limit on all operations. If you select any other output, only the selected function will operate.	
	Hysteresis settings	Hysteresis is set to prevent frequent output operation when the measured present value changes slightly near the set value	
	Output	Current output (retransmission)	-
Transistor output		-	PNP / NPN open collector output (12 - 24 V d.c. max. 50 mA)
Relay output		-	1a X 3 contacts (HI, GO, LO), (220 V a.c. 5 A)
Power voltage		100 - 240 V a.c. 50/60 Hz	
Allowable voltage fluctuation range		85 - 264 V a.c.	
Power consumption		Approx. 5 VA	Approx. 5 VA
Ambient temperature & humidity		-10 ~ 65 °C, 35 ~ 85 % RH (without condensation)	
Storage temperature		-20 ~ 65°C	
Vibration resistance		10 - 55 Hz single amplitude X·Y·Z each direction 2 hours	
Shock resistance		300 m/s, X·Y·Z each direction 3 times	
Weight		Approx. 180 g	



Suffix code

Model	Code	Content
MP	<input type="checkbox"/> <input type="checkbox"/> <input type="checkbox"/> <input type="checkbox"/>	Digital Frequency Meter
Appearance	3	96(W) × 48(H) mm
	6	72(W) × 36(H) mm
Display digits	4	4 digits (9999)
Output (optional)	N	Display only
	0	Relay output (HI, GO, LO) + Current output (4-20 mA)
	1	Relay output (HI, GO, LO)
	2	NPN TR Output (HI, GO, LO) + Current output (4-20 mA)
	3	PNP TR Output (HI, GO, LO) + Current output (4-20 mA)
Output (optional)	H	AC input frequency measurement

※ The optional specifications are MP6-4 H, and the MP3-4 H optional specifications will be developed in the future

BS series Digital Voltmeter / Ammeters

Specifications

Model	BS3	BS6	BS1
Appearance			
WXHXD (mm)	96.0×48×102.0	72.0×36.0×100.0	48.0×24.0×100.0
Input	Input signal		
	A/D converter		
	Sampling cycle		
	Response speed		
	External control		
	Max. display digits		
	Display		
Performance	Measurement and indication method		
	Accuracy		
	Insulation resistance		
	Dielectric strength		
Power voltage			
Voltage fluctuation rate			
Power consumption			
Ambient temperature & humidity			
Storage temperature			
Vibration resistance			
Shock resistance			
Weight			

Suffix code

※ Model name: BS6 and BS3 have different range codes

Model	Code	Content	
BS	<input type="checkbox"/> - <input type="checkbox"/> <input type="checkbox"/> <input type="checkbox"/> <input type="checkbox"/> <input type="checkbox"/>	Digital Voltmeter / Ammeter	
Appearance	6	72(W) × 36(H) mm	
	3	96(W) × 48(H) mm	
	1	48(W) × 24(H) mm	
Output	N	Display only	
Input	A	10	AC voltmeter (AC)
		20	AC ammeter (AC)
	D	10	DC voltmeter (DC)
		20	DC ammeter (DC)
		11	DC voltmeter
21	DC ammeter		
Measuring range	1	measuring range model example: BS3-NA101 (1.999 V)	

DC current (BS1)

Model	Measuring range	Resolution	Input impedance	Max. allowable input current
BS1-ND201	199.9 μA	0.1 μA	1 kΩ	50 mA
BS1-ND202	1.999 mA	1 μA	100 Ω	150 mA
BS1-ND203	19.99 mA	10 μA	10 Ω	300 mA
BS1-ND204	199.9 mA	100 μA	1 Ω	3 A
BS1-ND205	1.999 A	1 mA	0.1 Ω	3 A
BS1-ND206	5.00 A	10 mA	0.01 Ω	5 A
BS1-ND207	19.99 A	10 mA	Shunt use (secondary voltage 50mV)	
BS1-ND208	199.9 A	100 mA		
BS1-ND209	1999 A	1 A		

DC current (BS3)

Model	Measuring range	Resolution	Input impedance	Max. allowable input current
BS3-ND201	1.999 mA	1 μA	100 Ω	50 mA
BS3-ND202	19.99 mA	10 μA	10 Ω	150 mA
BS3-ND203	199.9 mA	100 μA	1 Ω	300 mA
BS3-ND204	1.999 A	1 mA	0.1 Ω	3 A
BS3-ND205	5.00 A	10 mA	0.01 Ω	5 A
BS3-ND206	19.99 A	10 mA	Shunt use (secondary voltage 50mV)	
BS3-ND207	199.9 A	100 mA		
BS3-ND208	1999 A	1 A		

DC current (BS6)

Model	Measuring range	Resolution	Input impedance	Max. allowable input current
BS6-ND201	199.9 μA	0.1 μA	100 Ω	1 mA
BS6-ND202	1.999 mA	1 μA	10 Ω	50 mA
BS6-ND203	19.99 mA	10 μA	1 Ω	150 mA
BS6-ND204	199.9 mA	100 μA	0.1 Ω	300 mA
BS6-ND205	5.00 A	10 mA	400 MΩ	5.1 A
BS6-ND206	19.99 A	10 mA	Shunt use (secondary voltage 50mV)	
BS6-ND207	199.9 A	100 mA		
BS6-ND208	1999 A	1 A		

Measuring range

AC current (BS3, BS6, BS1)

Model	Measuring range	Resolution	Input impedance	Max. allowable input voltage
BS□-NA201	19.99 mA	10 μA	10 Ω	50 mA
BS□-NA202	199.9 mA	100 μA	1 Ω	300 mA
BS□-NA203	1.999 A	1 mA	0.1 Ω	3 A
BS□-NA204	5.00 A	10 mA	40 MΩ	5.1 A
BS□-NA205	19.99 A	10 mA	Current transformer use (secondary current 5A)	
BS□-NA206	30.0 A	100 mA		
BS□-NA207	100.0 A	100 mA		
BS□-NA208	150.0 A	100 mA		
BS□-NA209	199.9 A	100 mA		
BS□-NA210	300 A	1 A		
BS□-NA211	1999 A	1 A		

AC voltage (BS3)

Model	Measuring range	Resolution	Input impedance	Max. allowable input voltage
BS3-NA101	1.999 V	1 mV	100 kΩ	10 V
BS3-NA102	19.99 V	10 mV	1 MΩ	50 V
BS3-NA103	199.9 V	100 mV	10 MΩ	300 V
BS3-NA104	400 V	1 V	10 MΩ	500 V
BS6-NA105	400 V	1 V	10 MΩ	500 V

AC voltage (BS6, BS1) ※ Model name: BS1-NA105 (range: 500V)

Model	Measuring range	Resolution	Input impedance	Max. allowable input voltage
BS □-NA101	199.9 mV	0.1 mV	10 kΩ	10 V
BS □-NA102	1.999 V	1 mV	100 kΩ	10 V
BS □-NA103	19.99 V	10 mV	1 MΩ	50 V
BS □-NA104	199.9 V	100 mV	10 MΩ	300 V
BS6-NA105	400 V	1 V	10 MΩ	500 V
BS1-NA105	500 V			

DC ammeter (BS3, BS6, BS1)

Model	Input	Display range	Input impedance	Max. allowable input current
BS □-ND211	4-20 mA d.c.	50.0	25 Ω	150 mA
BS □-ND212		100.0	50 Ω	150 mA
BS □-ND213		199.9	100 Ω	150 mA

DC voltmeter (BS3, BS6, BS1)

Model	Input	Display range	Input impedance	Max. allowable input voltage
BS □-ND111	1-5 V d.c.	50.0	500 kΩ	100 V
BS □-ND112		100.0	500 kΩ	100 V
BS □-ND113		199.9	500 kΩ	100 V

Input Measuring range 0 - 10 V d.c. (optional)

DC voltage (BS3, BS6, BS1)

Model	Measuring range	Resolution	Input impedance	Max. allowable input voltage
BS□-ND101	199.9 mV	0.1 mV	10 kΩ	70 V
BS□-ND102	1.999 V	1 mV	100 kΩ	100 V
BS□-ND103	19.99 V	10 mV	1 MΩ	200 V
BS□-ND104	199.9 V	100 mV	10 MΩ	300 V
BS□-ND105	500 V	1 V	10 MΩ	600 V

Panel Meters

BA1 Digital Voltmeter / Ammeters

Specifications

Model		BA1-D□□	BA1-D□□A
Appearance			
WXHxD (mm)		48.0×24.0×60.0	
Input	Input signal	Input voltage, current, instrument signal input (4 - 20 mA d.c. or 1 - 5 V d.c.)	
	A / D converter	Double integration method	
	Sampling cycle	300 ms	
	Response speed	Approx. 2 sec (max. range)	
	Max. display digits	±1999	
Performance	Accuracy	DC: ±0.2 % FS ±1 Digit	
	Insulation resistance	Min. 100 MΩ (500 V d.c.)	
	Dielectric strength	1500 V a.c. for 1 min (between power terminals and input terminals)	
Functions	Decimal point display	10 ¹ , 10 ² , 10 ³ display by rear terminal connection	
	Polarity display	If the input signal is reversed, "-" is displayed automatically	
	Range over display	Displayed as "1 □□□"	
	Range below display	Displayed as "-1□□□"	
	Display	7 segment LED	
Power voltage		5 V d.c.	12 - 24 V d.c.
Voltage fluctuation rate		±10 % of power voltage	
Power consumption		Approx. 5 W	Approx. 5 W
Ambient temperature & humidity		0 ~ 50 °C, 35 ~ 85 % RH (without condensation)	
Storage temperature		-10 ~ 70 °C	
Vibration resistance		10 ~ 55 Hz single amplitude X·Y·Z each direction 2 hours	
Shock resistance		300 m/s ² , X·Y·Z each direction 3 times	

Suffix code

Model	Code	Content
BA1-	□ □ □ □	Digital Voltmeter / Ammeter
Input	D 10	DC voltage (DC)
	D 20	DC current (DC)
	D 11	DC voltmeter (1 - 5 V d.c.)
	D 21	DC ammeter (4 - 20 mA d.c.)
Range code		Refer to measuring range
Power voltage		5 V d.c.
		A 12 - 24 V d.c.

Measuring range

● DC voltage

Model	Measuring range	Resolution	Input impedance	Max. allowable input voltage
BA1-D101	199.9 mV	100 μV	100 kΩ	70 V
BA1-D102	1.999 V	1 mV	1 MΩ	100 V
BA1-D103	19.99 V	10 mV	1 MΩ	250 V
BA1-D104	199.9 V	100 mV	10 MΩ	300 V
BA1-D111	1 - 5 V d.c.	50.0	100 kΩ	100 V
BA1-D112		100.0	100 kΩ	100 V
BA1-D113		199.9	100 kΩ	100 V

* Accuracy: ± 0.2% of present value ± 1 digit (23 °C ± 5 °C)

● DC current

Model	Measuring range	Resolution	Input impedance	Max. allowable input current
BA1-D201	199.9 μA	0.1 μA	1 kΩ	1 mA
BA1-D202	1.999 mA	1 μA	100 Ω	50 mA
BA1-D203	19.99 mA	10 μA	10 Ω	150 mA
BA1-D204	199.9 mA	100 μA	1 Ω	300 mA
BA1-D205	1.999 A	1 mA	Shunt use (secondary voltage 50 mV)	
BA1-D206	19.99 A	10 mA		
BA1-D207	199.9 A	100 mA		
BA1-D208	1999 A	1 A		
BA1-D211	4 - 20 mA d.c.	50.0	25 Ω	150 mA
BA1-D212		100.0	50 Ω	150 mA
BA1-D213		199.9	100 Ω	150 mA

* Accuracy: ± 0.2% of present value ± 1 digit (23 °C ± 5 °C)

HP3 Digital Scale Meters

Specifications

Model		HP3	
Appearance			
WXHxD (mm)		96.0×48.0×100.0	
Input	Input contact	1 channel	
	Input signal	4 - 20 mA / 1 - 5 V d.c. (2-wire current output and 3-wire voltage output type transducer only)	
	Max. display digits	5 digits (±19999)	
	Sampling cycle	500 ms	
	Input correction	-100 ~ 100 % of FS	
	Input filter setting	0 ~ 100 sec	
Performance	Accuracy	±0.03 % of FS	
	Retransmission output	4 - 20 mA d.c. (load resistance: max. 600 Ω)	
	Insulation resistance	100 MΩ (500 V d.c.)	
	Dielectric strength	2300 V a.c. 50/60 Hz for 1 min	
Functions	Alarm setting	2 contacts (AL1, AL2)	
	Alarm Hysteresis setting	AL1, AL2 each setting (0 ~ 10 % of FS)	
	Communication function	Select between RS232 or RS485	
	Retransmission type	Select retransmission output by parameter (DIR, REV, SQRT)	
	Scale setting	-19999 ~ 19999	
	Decimal places setting	0 ~ 4	
	Filter setting	0 ~ 100 sec	
	Present value correction	-100 ~ 100 % of FS	
	Sensor disconnection selection	Selection by parameter UP(0)/DOWN (1)/OFF(2)	
	LOCK Functions	Data setting lock function selection OFF (0) / ON (1)	
Output	Alarm output	Output points: 1c X 2 contacts (AL1, AL2)	
		Contact capacity: 5 A 240 V a.c. (5 A 30 V d.c.)	
		Resolution: 125 ms	
		Hysteresis: 0~10 % of FS	
Retransmission output	Retransmission type: Selection by parameter (DIR, REV, SQRT)		
	Output points: 1 contact		
	Output signal: 4 - 20 mA d.c. (load resistance max. 600 Ω)		
Normal specifications	Power voltage	100 - 240 V a.c. 50/60 Hz	
	Voltage fluctuation rate	±10 % of power voltage	
	Power consumption	Approx. 5 VA	
	Ambient temperature & humidity	-5 ~ 50 °C, 20 ~ 90 % RH (without condensation)	
	Storage temperature	-25 ~ 70 °C	
	Vibration resistance	10 - 55 Hz single amplitude X·Y·Z each direction 2 hours	
	Shock resistance	300 m/s ² , X·Y·Z directions each 3 times	
	Weight	300 g	

Suffix code

Model	Code	Content
HP3-	<input type="checkbox"/>	Digital Scale Meter
Option	0	No communication
	1	RS232
	2	RS485

Peripheral Devices

D55 Portable Thermometers

Specifications

Model		D55		
Appearance				
W×H×D (mm)		71.0×157.0×30.0		
Input	Thermocouple	K, J		
	Thermocouple specifications	Model D55 with "K" Type (Model: TC-POP) sensor included		
	Sensor and measuring range	Input	K Type thermocouple	J Type thermocouple
		Resolution	-100 ~ 1300 °C	-50 ~ 760 °C
Accuracy		0.1 °C, -50 ~ 1200 °C, 1 °C (outside of -50 °C ~ 1200 °C)	0.1 °C, -50 ~ 760 °C, 1 °C, -100 ~ -50 °C	
Power		9 V battery (6F22, 006P).		
Battery life		Approx. 200 hours		
Ambient temperature & humidity		0 ~ 50 °C, 0 ~ 90 % RH (without condensation)		
Electric field influence		Measurement error may occur in a low frequency or high frequency strong electric field		
Storage temperature		-40 ~ 60 °C		
Weight		Approx. 216 g		

Thermocouples

- TC-PJP

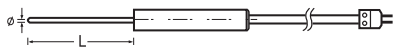

- TC-PIP

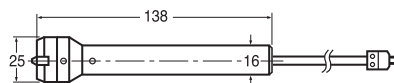

- TC-PLP

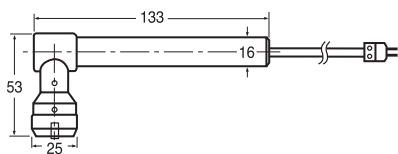

- TC-POP

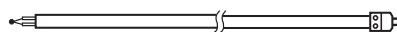

EM310 Data Storage Devices

Specifications

Model		EM310	
Appearance			
Power voltage		24 V d.c. 500 mA	
Communication method		Asynchronous serial communication (RS232C)	
Communication speed		38,400 bps	
Communication distance		Max. 5 m	
Setting method		Front switch operation method	
Storage medium		USB memory stick	
File system		FAT16, 32 support	
Internal memory		32 Mbyte (non-volatile)	
Applicable products		TH500, TH300, TD500, TS500 (however, TD500 and TH300 only support RS232 products)	

FS-3A Floatless level switches

Specifications

Model	FS-3A (high sensitivity)	FS-3A (low sensitivity)
Appearance		
Power voltage	110 V a.c. / 220 V a.c. 50/60 Hz	
Allowable voltage fluctuation range	±10 % of power voltage	
Inter-electrode voltage (secondary voltage)	24 V a.c.	8 V a.c.
Power consumption	Approx. 3.2 VA	
Response time	80 ms max. for operation, 160 ms max. for return	
Inter-electrode operation resistance	0 - Approx. 27 KΩ	0 - Approx. 7 KΩ
Inter-electrode return resistance	Approx. 38 KΩ - ∞ Ω	Approx. 15 KΩ - ∞ Ω
Control output	Relay contact outputs: (1c): 250 V a.c 5 A (resistive load)	
Insulation resistance	Min. 100 MΩ (500 V d.c Mega), conductive and exposed unfilled metal part	
Dielectric strength	2000 V a.c 50/60 Hz for 1 min (1st terminal - 2nd terminal)	
Vibration resistance	10 - 55 Hz (1 minute cycle) single amplitude: 0.76 mm X, Y, Z each direction 2 hours	
Shock resistance	300 m/s²	
Life	Mechanical: min. 5 million times (relay type), electrical: 500,000 times min (resistive load)	
Ambient temperature & humidity	-10 ~ 50 °C, 35 ~ 85 % RH (without condensation)	

HY-ER3 Fuse holders

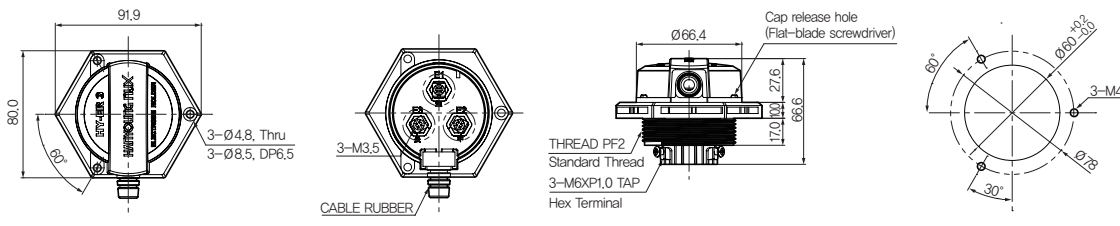
Appearance	Dimension
	 <p>91.9 80.0 60° 3-Ø4.8, Thru 3-Ø8.5, DP6.5 3-M3.5 CABLE RUBBER Ø66.4 Cap release hole (Flat-blade screwdriver) 27.6 66.6 17.0 THREAD PF2 / Standard Thread 3-M6X1.0 TAP Hex Terminal Ø80 +0.2 Ø78 30°</p>

Usage example

Example of Water Supply connection (with FS-3A)

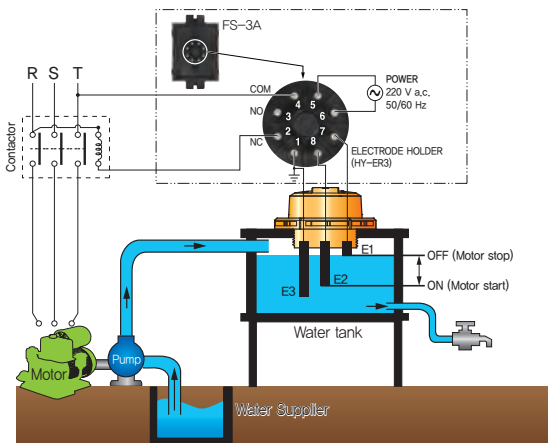

Example of Drain connection (with FS-3A)

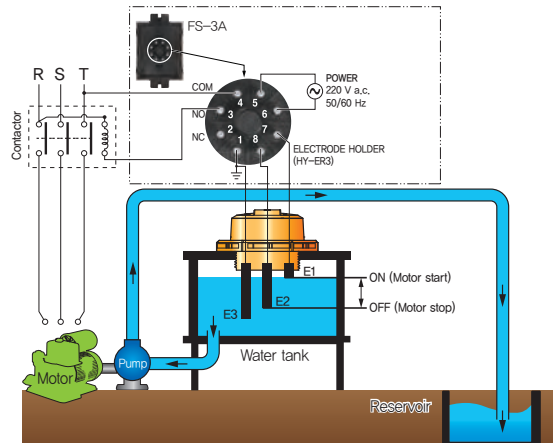

Peripheral Devices

■ HMCW-103 WiFi To Serial Converters

■ Specifications

Model	HMCW-103
Appearance	
CPU	PIC32MX695F512L
Memory	SRAM: 128 Kbit, Flash : 512 Kbit
Input voltage	5 V d.c. (±10 %)
Max. Current	Max. under 250 mA
RS232 communication	Data communication / serial console male DB9 serial port Communication speed: 4800 ~ 115200 bps Flow control: None Signal: TX, RX, GND
RS485 communication	2-wire half-duplex method for data communication Communication speed: 4800 ~ 115200 bps Flow control: DE/RE Signal: TX+, TX-
RS422 communication	4-wire full-duplex method for data communication Communication speed: 4800 ~ 115200 bps Flow control: None Signal: TX+, RX+, TX-, RX-
Ethernet communication	Wi-Fi Fluid IP support It is possible to access many clients (up to 3) ARP, IP/ICMP, TCP, Telnet, DHCP support
Ambient setting	Telnet or serial console interface
LED	● Power input display ● Activation status display
Ambient temperature	-10 °C ~ 60 °C
Storage temperature	-30 °C ~ 80 °C
Certification standard	MSIP-CRM-NUX-HMCW-103
Warranty period	1 year
Weight	74 g (except antenna)

■ CV250 Temperature / Humidity Converters

■ Specifications

Model	CV250
Appearance	
Power voltage	100 / 240 V a.c. 50/60 Hz
Power consumption	Approx. 3 VA
Input signal	RTD : Pt100 Ω (IEC751), DRY / WET each 1 year ※ Transmitter for dry and wet bulb (Hanyoung Nux model HY-PT230)
Measuring range	Temperature: 0 ~ 100 °C, Humidity: 0 ~ 100 % RH
Accuracy	Temperature: ±0.5 %, Humidity: ±1 % RH
Output signal	Individual temperature/humidity output (Current by suffix code / output selection), 4 - 20 mA d.c. (load resistance max. 600 Ω), 1 - 5 V d.c. (load resistance 1 kΩ min)
Output compensation	±5 % (offset correction by variable resistor)
Insulation resistance	Min. 20 MΩ (500 V d.c.)
Dielectric strength	2500 V a.c. (power terminal-signal input/output terminal)
Ambient temperature & humidity	0 ~ 50 °C, 35 ~ 85 % RH (without condensation)
Storage temperature	-25 ~ 65 °C
Weight	Approx. 300g

■ Suffix code

Model	Code	Content
CV250-	□	Temperature / Humidity Converter
Output signal	C	4 - 20 mA d.c.
	V	1 - 5 V d.c.

■ HMCE-103 Ethernet To Serial Converters

■ Specifications

Model	HMCE-103	
Appearance		
CPU	PIC32MX695F512L	
Memory	SRAM: 128 Kbit, Flash : 512 Kbit	
Input voltage	5 V d.c. (±10 %)	
Max. Current	Max. 200 mA	
RS232 communication	Data communication / Serial console Male DB9 Serial Port	
	Communication speed: 2400 ~ 115200 bps	
	Flow control: None Signal: TX, RX, GND	
RS485 communication	2-wire half-duplex method for data communication	
	Communication speed: 2400 ~ 115200 bps	
	Flow control: DE/RE Signal: TX+, TX-	
RS422 communication	4-wire full-duplex method for data communication	
	Communication speed: 2400 ~ 115200 bps	
	Flow control: None Signal: TX+, RX+, TX-, RX-	
Ethernet communication	10/100 Base-T Ethernet (RJ-45 connector)	
	Fixed and fluid IP support	
	It is possible to access many clients (up to 3)	
	ARP, IP/ICMP, TCP, Telnet, DHCP	
Ambient setting	Telnet or serial console interface	
LED	● Power input display ● Activation status display	
Ambient temperature	-10 ~ 60 °C	
Storage temperature	-30 ~ 80 °C	
Certification standard	KCC-REM-NUX-HMCE-103	
Warranty period	1 year	
Weight	74 g	

■ CV310 Communication Converters

■ Specifications



Model	CV310	
Appearance		
W×H×D (mm)	49.3×33.0×17.8	
Power voltage	9 - 30 V d.c.	
Max. communication speed	460800 bps	
Communication distance	Max. 1.2 km , 256 node connectable	
Safety	Built-in 2kV protection device for RS232 and RS485 / RS422	
Function setting	2-wire / 4-wire, built-in terminal resistor use/not use, full / half-duplex	
Setting switch	4 Pin Dip Switch	
Weight	Approx. 24 g	

Proximity Sensors

■ UP series Round Type Proximity Sensors

Specifications

■ Inductive DC 3 wire type

Model	NPN	UP8RM-1.5N□□	UP8RD-2N□□	UP12RM-2N□□	UP12RD-4N□□
	PNP	UP8RM-1.5P□□	UP8RD-2P□□	UP12RM-2P□□	UP12RD-4P□□
Appearance					
Shield	Shield		Non shield	Shield	Non shield
Standard sensing object(mm)	Iron 8 X 8 X 1			Iron 12 X 12 X 1	
Sensing distance	1.5 mm		2 mm	2 mm	4 mm
Setting distance	0 ~ 1.2 mm		0 ~ 1.6 mm	0 ~ 1.6 mm	0 ~ 3.2 mm
Hysteresis	Less than 10% of sensing distance				
Response frequency	800 Hz			800 Hz	600 Hz
Power voltage	12 - 24 V d.c. (usable voltage range 5 - 35 V d.c.)				
Control output	Max. 200 mA (resistive load)				
Residual voltage	Max. 1.5 V				
Current consumption	Max. 6 mA				
Operation indication	Red LED				
Protection circuit	Power reversely connected protective circuit, surge protective circuit and over current protective circuit are built-in.				
Ambient temperature & humidity	-25 ~ 70 °C (less than ±10 % of sensing distance at temperature 20 °C), 35 ~ 85 %RH				
Insulation resistance	Min. 50 MΩ (500 V d.c. mega standard)				
Dielectric strength	2000 V a.c. 50/60 Hz for 1 min (between the recharging part and case)				
Vibration resistance	10 - 55 Hz (1 min cycle, double amplitude: 1.5 mm 2 hours for each of X, Y and Z directions)				
Shock resistance	500 m/s ² 3 times to each of X, Y and Z directions				
Degree of protection	IP67 (IEC 60529)				
Connection structure	Cable type (standard cable length 2 m), relay connector type, connector type				
Color	NPN: green, PNP: purple				
Material	Case: stainless, Sensing surface: PBT, Cable holder: polyester elastomer			Case: brass (chrome plating), Sensing surface: PBT, Cable holder: polyester elastomer	

■ Inductive DC 3 wire type

Model	NPN	UP18RM-5N□□	UP18RD-8N□□	UP18RLM-5N□□	UP18RLD-8N□□
	PNP	UP18RM-5P□□	UP18RD-8P□□	UP18RLM-5P□□	UP18RLD-8P□□
Appearance					
Shield	Shield		Non shield	Shield	Non shield
Standard sensing object(mm)	Iron 18×18×1		Iron 25×25×1	Iron 18×18×1	Iron 25×25×1
Sensing distance	5 mm		8 mm	5 mm	8 mm
Setting distance	0 ~ 4 mm		0 ~ 6.4 mm	0 ~ 4 mm	0 ~ 6.4 mm
Hysteresis	Less than 10% of sensing distance				
Response frequency	500 Hz		350 Hz	500 Hz	350 Hz
Power voltage	12 - 24 V d.c. (usable voltage range 5 - 35 V d.c.)				
Control output	Max. 200 mA (resistive load)				
Residual voltage	Max. 1.5 V				
Current consumption	Max. 6 mA				
Operation indication	Red LED				
Protection circuit	Power reversely connected protective circuit, surge protective circuit and over current protective circuit are built-in.				
Ambient temperature & humidity	-25 ~ 70 °C (less than ±10 % of sensing distance at temperature 20 °C), 35 ~ 85 % RH				
Insulation resistance	Min. 50 MΩ (500 V d.c. mega standard)				
Dielectric strength	2000 V a.c. 50/60 Hz for 1 min (between the recharging part and case)				
Vibration resistance	10 - 55 Hz (1 min cycle, double amplitude: 1.5 mm 2 hours for each of X, Y and Z directions)				
Shock resistance	500 m/s ² 3 times to each of X, Y and Z directions				
Degree of protection	IP67 (IEC 60529)				
Connection structure	Cable type (standard cable length 2 m), relay connector type, connector type				
Color	NPN: green, PNP: purple				
Material	Case: brass (chrome plating), Sensing surface: PBT, cable holder: polyester elastomer				

Proximity Sensors

■ Inductive DC 3 wire type **CE**

Model	NPN	UP30RM-10N□□	UP30RD-15N□□	UP30RLM-10N□□	UP30RLD-15N□□
	PNP	UP30RM-10P□□	UP30RD-15P□□	UP30RLM-10P□□	UP30RLD-15P□□
Appearance					
Shield	Shield		Non shield	Shield	Non shield
Standard sensing object(mm)	Iron 30×30×1		Iron 45×45×1	Iron 30×30×1	Iron 45×45×1
Sensing distance	10 mm		15 mm	10 mm	15 mm
Setting distance	0 ~ 8 mm		0 ~ 12 mm	0 ~ 8 mm	0 ~ 12 mm
Hysteresis	Less than 10% of sensing distance				
Response frequency	300 Hz		200 Hz	300 Hz	200 Hz
Power voltage	12 - 24 V d.c. (usable voltage range 5 - 35 V d.c.)				
Control output	Max. 200 mA (resistive load)				
Residual voltage	Max. 1.5 V				
Current consumption	Max. 6 mA				
Operation indication	Red LED				
Protection circuit	Power reversely connected protective circuit, surge protective circuit and over current protective circuit are built-in.				
Ambient temperature & humidity	-25 ~ 70 °C (less than ±10 % of sensing distance at temperature 20 °C), 35 ~ 85 %RH				
Insulation resistance	Min. 50 MΩ (500 V d.c. mega standard)				
Dielectric strength	2000 V a.c. 50/60 Hz for 1 min (between the recharging part and case)				
Vibration resistance	10 - 55 Hz (1 min cycle, double amplitude: 1.5 mm 2 hours for each of X, Y and Z directions)				
Shock resistance	500 m/s ² 3 times to each of X, Y and Z directions				
Degree of protection	IP67 (IEC 60529)				
Connection structure	Cable type (standard cable length 2 m), relay connector type, connector type				
Color	NPN: green, PNP: purple				
Material	Case: brass (chrome plating), Sensing surface: PBT, cable holder: polyester elastomer				

■ Inductive DC 2 wire type (Polarity / No polarity) **CE**

Model	Polar	UP8RM-1.5T□□	UP8RD-2T□□	UP12RM-2T□□	UP12RD-4T□□
	No polarity	-	-	UP12RM-2U□□	UP12RD-4U□□
Appearance					
Shield	Shield		Non shield	Shield	Non shield
Standard sensing object(mm)	Iron 8×8×1		Iron 8×8×1	Iron 12×12×1	Iron 12×12×1
Sensing distance	1.5 mm		2 mm	2 mm	4 mm
Setting distance	0 ~ 1.2 mm		0 ~ 1.6 mm	0 ~ 1.6 mm	0 ~ 3.2 mm
Hysteresis	Less than 10% of sensing distance				
Response frequency	800 Hz		800 Hz	800 Hz	600 Hz
Power voltage	12 - 24 V d.c. (usable voltage range 5 - 30 V d.c.)				
Control output	Max. 100 mA (resistive load)				
Residual voltage	T (polarity): max. 3.5 V, U (no polarity): max. 5 V				
Leakage current	Max. 1 mA				
Operation indication	Red LED				
Protection circuit	Surge protective circuit and over current protective circuit are built-in.				
Ambient temperature & humidity	-25 ~ 70 °C (less than ±10 % of sensing distance at temperature 20 °C), 35 ~ 85 % RH				
Insulation resistance	Min. 50 MΩ (500 V d.c. mega standard)				
Dielectric strength	2000 V a.c. 50/60 Hz for 1 min (between the recharging part and case)				
Vibration resistance	10 - 55 Hz (1 min cycle, double amplitude: 1.5 mm 2 hours for each of X, Y and Z directions)				
Shock resistance	500 m/s ² 3 times to each of X, Y and Z directions				
Degree of protection	IP67 (IEC 60529)				
Connection structure	Cable type (standard cable length 2 m), relay connector type, connector type				
Color	NO: green, NC: purple				
Material	Case: stainless, Sensing surface: PBT, Cable holder: polyester elastomer			Case: brass (chrome plating), Sensing surface: PBT, Cable holder: polyester elastomer	

Proximity Sensors

■ Inductive DC 2 wire type (Polarity / No polarity)

Model	Polar	UP18RM-5T□□	UP18RD-8T□□	UP18RLM-5T□□	UP18RLD-8T□□	
	No polarity	UP18RM-5U□□	UP18RD-8U□□	UP18RLM-5U□□	UP18RLD-8U□□	
Appearance						
Shield	Shield		Non shield		Shield	
Standard sensing object(mm)	Iron 18×18×1		Iron 25×25×1		Iron 18×18×1	
Sensing distance	5 mm		8 mm		5 mm	
Setting distance	0 ~ 4 mm		0 ~ 6.4 mm		0 ~ 4 mm	
Hysteresis	Less than 10% of sensing distance					
Response frequency	500 Hz		350 Hz		500 Hz	
Power voltage	12 - 24 V d.c. (usable voltage range 5 - 30 V d.c.)					
Control output	Max. 100 mA (resistive load)					
Residual voltage	T (polarity): max. 3.5 V, U (no polarity): max. 5 V					
Leakage current	Max. 1 mA					
Operation indication	Red LED					
Protection circuit	Surge protective circuit and over current protective circuit are built-in.					
Ambient temperature & humidity	-25 ~ 70 °C (less than ±10 % of sensing distance at temperature 20 °C), 35 ~ 85 % RH					
Insulation resistance	Min. 50 MΩ (500 V d.c. mega standard)					
Dielectric strength	2000 V a.c. 50/60 Hz for 1 min (between the recharging part and case)					
Vibration resistance	10 - 55 Hz (1 min cycle, double amplitude: 1.5 mm 2 hours for each of X, Y and Z directions)					
Shock resistance	500 m/s ² 3 times to each of X, Y and Z directions					
Degree of protection	IP67 (IEC 60529)					
Connection structure	Cable type (standard cable length 2 m), relay connector type, connector type					
Color	NO: green, NC: purple					
Material	Case: brass (chrome plating), Sensing surface: PBT, cable holder: polyester elastomer					

■ Inductive DC 2 wire type (Polarity / No polarity)

Model	Polar	UP30RM-10T□□	UP30RD-15T□□	UP30RLM-10T□□	UP30RLD-15T□□	
	No polarity	UP30RM-10U□□	UP30RD-15U□□	UP30RLM-10U□□	UP30RLD-15U□□	
Appearance						
Shield	Shield		Non shield		Shield	
Standard sensing object(mm)	Iron 30×30×1		Iron 45×45×1		Iron 30×30×1	
Sensing distance	10 mm		15 mm		10 mm	
Setting distance	0 ~ 8 mm		0 ~ 12 mm		0 ~ 8 mm	
Hysteresis	Less than 10% of sensing distance					
Response frequency	300 Hz		200 Hz		300 Hz	
Power voltage	12 - 24 V d.c. (usable voltage range 5 - 30 V d.c.)					
Control output	Max. 100 mA (resistive load)					
Residual voltage	T (polarity): max. 3.5 V, U (no polarity): max. 5 V					
Leakage current	Max. 1 mA					
Operation indication	Red LED					
Protection circuit	Surge protective circuit and over current protective circuit are built-in.					
Ambient temperature & humidity	-25 ~ 70 °C (less than ±10 % of sensing distance at temperature 20 °C), 35 ~ 85 % RH					
Insulation resistance	Min. 50 MΩ (500 V d.c. mega standard)					
Dielectric strength	2000 V a.c. 50/60 Hz for 1 min (between the recharging part and case)					
Vibration resistance	10 - 55 Hz (1 min cycle, double amplitude: 1.5 mm 2 hours for each of X, Y and Z directions)					
Shock resistance	500 m/s ² 3 times to each of X, Y and Z directions					
Degree of protection	IP67 (IEC 60529)					
Connection structure	Cable type (standard cable length 2 m), relay connector type, connector type					
Color	NO: green, NC: purple					
Material	Case: brass (chrome plating), Sensing surface: PBT, cable holder: polyester elastomer					

Proximity Sensors

■ Inductive AC 2 wire type

Model	UP12RM-2A□□	UP12RD-4A□□
Appearance		
Shield	Shield	Non shield
Standard sensing object(mm)	Iron 12×12×1	
Sensing distance	2 mm	4 mm
Setting distance	0 ~ 1.6 mm	0 ~ 3.2 mm
Hysteresis	Less than 10 % of sensing distance	
Response frequency	20 Hz	
Power voltage	100 - 240 V a.c. (usable voltage range 90 - 250 V a.c.)	
Control output	Max. 200 mA (resistive load)	
Residual voltage	Max. 10 V	
Leakage current	Max. 2.2 mA	
Operation indication	Red LED	
Protection circuit	Surge protective circuit built-in.	
Ambient temperature & humidity	-25 ~ 70 °C (less than ±10 % of sensing distance at temperature 20 °C), 35 ~ 85 %RH	
Insulation resistance	Min. 50 MΩ (500 V d.c. mega standard)	
Dielectric strength	2000 V a.c. 50/60 Hz for 1 min (between the recharging part and case)	
Vibration resistance	10 - 55 Hz (1 min cycle, double amplitude: 1.5 mm 2 hours for each of X, Y and Z directions)	
Shock resistance	500 m/s ² 3 times to each of X, Y and Z directions	
Degree of protection	IP67 (IEC 60529)	
Connection structure	Cable type (standard cable length 2 m), relay connector type, connector type	
Color	NO: green, NC: purple	
Material	Case: brass (chrome plating), Sensing surface: PBT, cable holder: polyester elastomer	

■ Inductive AC 2 wire type

Model	UP18RM-5A□□	UP18RD-8A□□	UP18RLM-5A□□	UP18RLD-8A□□
Appearance				
Shield	Shield	Non shield	Shield	Non shield
Standard sensing object(mm)	Iron 18×18×1	Iron 25×25×1	Iron 18×18×1	Iron 25×25×1
Sensing distance	5 mm	8 mm	5 mm	8 mm
Setting distance	0 ~ 4 mm	0 ~ 6.4 mm	0 ~ 4 mm	0 ~ 6.4 mm
Hysteresis	Less than 10 % of sensing distance			
Response frequency	20 Hz			
Power voltage	100 - 240 V a.c. (usable voltage range 90 - 250 V a.c.)			
Control output	Max. 200 mA (resistive load)			
Residual voltage	Max. 10 V			
Leakage current	Max. 2.2 mA			
Operation indication	Red LED			
Protection circuit	Surge protective circuit built-in.			
Ambient temperature & humidity	-25 ~ 70 °C (less than ±10 % of sensing distance at temperature 20 °C), 35 ~ 85 %RH			
Insulation resistance	Min. 50 MΩ (500 V d.c. mega standard)			
Dielectric strength	2000 V a.c. 50/60 Hz for 1 min (between the recharging part and case)			
Vibration resistance	10 - 55 Hz (1 min cycle, double amplitude: 1.5 mm 2 hours for each of X, Y and Z directions)			
Shock resistance	500 m/s ² 3 times to each of X, Y and Z directions			
Degree of protection	IP67 (IEC 60529)			
Connection structure	Cable type (standard cable length 2 m), relay connector type, connector type			
Color	NO: green, NC: purple			
Material	Case: brass (chrome plating), Sensing surface: PBT, cable holder: polyester elastomer			

Proximity Sensors

Inductive AC 2 wire type

Model	UP30RM-10A□□	UP30RD-15A□□	UP30RLM-10A□□	UP30RLD-15A□□
Appearance				
Shield	Shield	Non shield	Shield	Non shield
Standard sensing object(mm)	Iron 30×30×1	Iron 45×45×1	Iron 30×30×1	Iron 45×45×1
Sensing distance	10 mm	15 mm	10 mm	15 mm
Setting distance	0 ~ 8 mm	0 ~ 12 mm	0 ~ 8 mm	0 ~ 12 mm
Hysteresis	Less than 10 % of sensing distance			
Response frequency	20 Hz			
Power voltage	100 - 240 V a.c. (usable voltage range 90 - 250 V a.c.)			
Control output	Max. 200 mA (resistive load)			
Residual voltage	Max. 10 V			
Leakage current	Max. 2.2 mA			
Operation indication	Red LED			
Protection circuit	Surge protective circuit built-in.			
Ambient temperature & humidity	-25 ~ 70 °C (less than ±10 % of sensing distance at temperature 20 °C), 35 ~ 85 % RH			
Insulation resistance	Min. 50 MΩ (500 V d.c. mega standard)			
Dielectric strength	2000 V a.c. 50/60 Hz for 1 min (between the recharging part and case)			
Vibration resistance	10 - 55 Hz (1 min cycle, double amplitude: 1.5 mm 2 hours for each of X, Y and Z directions)			
Shock resistance	500 m/s ² 3 times to each of X, Y and Z directions			
Degree of protection	IP67 (IEC 60529)			
Connection structure	Cable type (standard cable length 2 m), relay connector type, connector type			
Color	NO: green, NC: purple			
Material	Case: brass (chrome plating), Sensing surface: PBT, cable holder: polyester elastomer			



Suffix code

Model	Code						Content
UP	□	□ -	□	□	□	□	Inductive Type Proximity Sensor
Sensing area size	8						M8
	12						M12
	18						M18
	30						M30
Structure type	RM						Round type Shield
	RD						Round type Non Shield
	RLM						Long round type Shield (M8 and M12 are excluded)
	RLD						Long round type Non Shield (M8 and M12 are excluded)
Sensing distance	*						Please refer to the sensing distance of each specification (unit: mm)
Power and output type	N						DC NPN output
	P						DC PNP output
	A						AC 2 wire type
	T						DC 2 wire type (polarity)
	U						DC 2 wire type (no polarity) ※ But M8 is excluded
Output state	A						Normal Open (N.O)
	C						Normal Close (N.C)
Connection structure	*						Cable type
	CR						Relay connector type
	C						Connector type



■ UP series Square Type Proximity Sensors

■ Specifications

■ Inductive DC 3 wire type



Model	NPN	UP12S-4N □□	UP18S-5N □□	UP18S-8N □□
	PNP	UP12S-4P □□	UP18S-5P □□	UP18S-8P □□
Appearance				
Standard sensing object(mm)	Iron 12X12X1		Iron 18X18X1	Iron 25X25X1
Sensing distance	4 mm		5 mm	8 mm
Setting distance	0 ~ 3.2 mm		0 ~ 4 mm	0 ~ 6.4 mm
Hysteresis	Less than 10 % of sensing distance			
Response frequency	600 Hz		500 Hz	350 Hz
Power voltage	12 - 24 V d.c. (usable voltage range 5 - 35 V d.c.)			
Control output	Open/Close capacitance	Max. 200 mA (resistive load)		
	Residual voltage	Max. 1.5 V		
Current consumption	Max. 6 mA			
Operation indication	Red LED			
Protective circuit	Power reversely connected protective circuit, surge protective circuit and over current protective circuit are built-in.			
Degree of protection	IP67 (IEC 60529)			
Connection structure	Cable type (standard cable length 2 m), relay connector type			
Ambient temperature & humidity	-25 ~ 70 °C (less than ±10 % of sensing distance at temperature 20 °C), 35 ~ 85 %RH			
Insulation resistance	Min. 50 MΩ (500 V d.c. mega standard)			
Dielectric strength	2000 V a.c. 50/60 Hz for 1 min (between the recharging part and case)			
Vibration resistance	10 - 55 Hz (1 min cycle, double amplitude: 1.5 mm 2 hours for each of X, Y and Z directions)			
Shock resistance	500 m/s ² 3 times to each of X, Y and Z directions			
Material	Case: PBT resin, cable holder: polyester elastomer			
Weight	Cable type	Approx. 45g	Approx. 60g	Approx. 60g
	Relay connector type	Approx. 15g	Approx. 20g	Approx. 20g

■ Inductive DC 3 wire type



Model	NPN	UP25S-5N □□	UP25S-8N □□	UP25S-12N □□	UP30S-10N □□	UP30S-15N □□	UP40S-20N □□
	PNP	UP25S-5P □□	UP25S-8P □□	UP25S-12P □□	UP30S-10P □□	UP30S-15P □□	UP40S-20P □□
Appearance							
Standard sensing object(mm)	Iron 25 X 25 X 1	Iron 30 X 30 X 1	Iron 35 X 35 X 1	Iron 30 X 30 X 1	Iron 45 X 45 X 1	Iron 60 X 60 X 1	
Sensing distance	5 mm	8 mm	12 mm	10 mm	15 mm	20 mm	
Setting distance	0 ~ 4 mm	0 ~ 6.4 mm	0 ~ 9.6 mm	0 ~ 8 mm	0 ~ 12 mm	0 ~ 16 mm	
Hysteresis	Less than 10% of sensing distance						
Response frequency	500 Hz	350 Hz	250 Hz	300 Hz	200 Hz	150 Hz	
Power voltage	12 - 24 V d.c. (usable voltage range 5 - 35 V d.c.)						
Control output	Open/Close capacitance	Max. 200 mA (resistive load)					
	Residual voltage	Max. 1.5 V					
Current consumption	Max. 6 mA						
Operation indication	Red LED						
Protective circuit	Power reversely connected protective circuit, surge protective circuit and over current protective circuit are built-in.						
Degree of protection	IP67 (IEC 60529)						
Connection structure	Cable type (standard cable length 2 m), relay connector type						
Ambient temperature & humidity	-25 ~ 70 °C (less than ±10 % of sensing distance at temperature 20 °C), 35 ~ 85 % RH						
Insulation resistance	Min. 50 MΩ (500 V d.c. mega standard)						
Dielectric strength	2000 V a.c. 50/60 Hz for 1 min (between the recharging part and case)						
Vibration resistance	10 - 55 Hz (1 min cycle, double amplitude: 1.5 mm 2 hours for each of X, Y and Z directions)						
Shock resistance	500 m/s ² 3 times to each of X, Y and Z directions						
Material	Case: PBT resin, cable holder: polyester elastomer						
Weight	Cable type	Approx. 80g	Approx. 80g	Approx. 80g	Approx. 90g	Approx. 90g	Approx. 110g
	Relay connector type	Approx. 40g	Approx. 40g	Approx. 40g	Approx. 60g	Approx. 60g	Approx. 80g

Proximity Sensors

■ Inductive DC 2 wire type



Model	Polarity	UP12S-4T □□	UP18S-5T □□	UP18S-8T □□
	Non polarity	UP12S-4U □□	UP18S-5U □□	UP18S-8U □□
Appearance				
Standard sensing object(mm)		Iron 12X12X1	Iron 18X18X1	Iron 25X25X1
Sensing distance		4 mm	5 mm	8 mm
Setting distance		0 ~ 3.2 mm	0 ~ 4 mm	0 ~ 6.4 mm
Hysteresis		Less than 10 % of sensing distance		
Response frequency		600 Hz	500 Hz	350 Hz
Power voltage		12 - 24 V d.c. (usable voltage range 5 - 30 V d.c.)		
Control output	Open/Close capacitance	Max. 100 mA (resistive load)		
	Residual voltage	Max. 1.5 V		
Leakage current		Max. 6 mA		
Operation indication		Red LED		
Protective circuit		Power reversely connected protective circuit, surge protective circuit and over current protective circuit are built-in.		
Degree of protection		IP67 (IEC 60529)		
Connection structure		Cable type (standard cable length 2 m), relay connector type		
Ambient temperature & humidity		-25 ~ 70 °C (less than ±10 % of sensing distance at temperature 20 °C), 35 ~ 85 %RH		
Insulation resistance		Min. 50 MΩ (500 V d.c. mega standard)		
Dielectric strength		2000 V a.c. 50/60 Hz for 1 min (between the recharging part and case)		
Vibration resistance		10 - 55 Hz (1 min cycle, double amplitude: 1.5 mm 2 hours for each of X, Y and Z directions)		
Shock resistance		500 m/s ² 3 times to each of X, Y and Z directions		
Material		Case: PBT resin, cable holder: polyester elastomer		
Weight	Cable type	Approx. 45g	Approx. 60g	Approx. 60g
	Relay connector type	Approx. 15g	Approx. 20g	Approx. 20g

■ Inductive DC 2 wire type



Model	Polarity	UP25S-5T □□	UP25S-8T □□	UP25S-12T □□	UP30S-10T □□	UP30S-15T □□	UP40S-20T □□
	Non polarity	UP25S-5U □□	UP25S-8U □□	UP25S-12U □□	UP30S-10U □□	UP30S-15U □□	UP40S-20U □□
Appearance							
Standard sensing object(mm)		Iron 25 X 25 X 1	Iron 30 X 30 X 1	Iron 35 X 35 X 1	Iron 30 X 30 X 1	Iron 45 X 45 X 1	Iron 60 X 60 X 1
Sensing distance		5 mm	8 mm	12 mm	10 mm	15 mm	20 mm
Setting distance		0 ~ 4 mm	0 ~ 6.4 mm	0 ~ 9.6 mm	0 ~ 8 mm	0 ~ 12 mm	0 ~ 16 mm
Hysteresis		Less than 10 % of sensing distance					
Response frequency		500 Hz	350 Hz	250 Hz	300 Hz	200 Hz	150 Hz
Power voltage		12 - 24 V d.c. (usable voltage range 5 - 30 V d.c.)					
Control output	Open/Close capacitance	Max. 100 mA (resistive load)					
	Residual voltage	T (polarity): max. 3.5V, U (Non polarity): max. 5V					
Leakage current		Max. 1 mA					
Operation indication		Red LED					
Protective circuit		Power reversely connected protective circuit, surge protective circuit and over current protective circuit are built-in.					
Degree of protection		IP67 (IEC 60529)					
Connection structure		Cable type (standard cable length 2 m), relay connector type					
Ambient temperature & humidity		-25 ~ 70 °C (less than ±10 % of sensing distance at temperature 20 °C), 35 ~ 85 %RH					
Insulation resistance		Min. 50 MΩ (500 V d.c. mega standard)					
Dielectric strength		2000 V a.c. 50/60 Hz for 1 min (between the recharging part and case)					
Vibration resistance		10 - 55 Hz (1 min cycle, double amplitude: 1.5 mm 2 hours for each of X, Y and Z directions)					
Shock resistance		500 m/s ² 3 times to each of X, Y and Z directions					
Material		Case: PBT resin, cable holder: polyester elastomer					
Weight	Cable type	Approx. 80g	Approx. 80g	Approx. 80g	Approx. 90g	Approx. 90g	Approx. 110g
	Relay connector type	Approx. 40g	Approx. 40g	Approx. 40g	Approx. 60g	Approx. 60g	Approx. 80g

Proximity Sensors

■ Inductive AC 2 wire type

Model	For AC	UP25S-5A □□	UP25S-8A □□	UP30S-10A □□
Appearance				
Standard sensing object(mm)		Iron 25 X 25 X 1		Iron 30 X 30 X 1
Sensing distance		5 mm	8 mm	10 mm
Setting distance		0 ~ 4 mm	0 ~ 6.4 mm	0 ~ 8 mm
Hysteresis		Less than 10% of sensing distance		
Response frequency		20 Hz		
Power voltage		100 - 240 V a.c. (usable voltage range 90 - 250 V a.c.)		
Control output	Open/Close capacitance	Max. 200 mA (resistive load)		
	Residual voltage	Max. 10 V a.c.		
Leakage current		Max. 2.2 mA		
Operation indication		Red LED		
Protective circuit		Surge protective circuit is built-in.		
Degree of protection		IP67 (IEC 60529)		
Connection structure		Cable type (Standard cable length 2 m), relay connector type		
Ambient temperature & humidity		-25 ~ 70 °C (less than ±10 % of sensing distance at temperature 20 °C), 35 ~ 85 %RH		
Insulation resistance		Min. 50 MΩ (500 V d.c. mega standard)		
Dielectric strength		2000 V a.c. 50/60 Hz for 1 min (between the recharging part and case)		
Vibration resistance		10 - 55 Hz (1 min cycle, double amplitude: 1.5 mm 2 hours for each of X, Y and Z directions)		
Shock resistance		500 m/s ² 3 times to each of X, Y and Z directions		
Material		Case: PBT resin, cable holder: polyester elastomer		
Weight	Cable type	Approx. 80g	Approx. 80g	Approx. 90g
	Relay connector type	Approx. 40g	Approx. 40g	Approx. 80g

■ Inductive AC 2 wire type

Model	For AC	UP30S-15A □□	UP40S-20A □□
Appearance			
Standard sensing object(mm)		Iron 45 X 45 X 1	Iron 60 X 60 X 1
Sensing distance		15 mm	20 mm
Setting distance		0 ~ 12 mm	0 ~ 16 mm
Hysteresis		Less than 10 % of sensing distance	
Response frequency		20 Hz	
Power voltage		100 - 240 V a.c. (usable voltage range 90 - 250 V a.c.)	
Control output	Open/Close capacitance	Max. 200 mA (resistive load)	
	Residual voltage	Max. 10 V a.c.	
Leakage current		Max. 2.2 mA	
Operation indication		Red LED	
Protective circuit		Surge protective circuit is built-in.	
Degree of protection		IP67 (IEC 60529)	
Connection structure		Cable type (Standard cable length 2 m), relay connector type	
Ambient temperature & humidity		-25 ~ 70 °C (less than ±10 % of sensing distance at temperature 20 °C), 35 ~ 85 % RH	
Insulation resistance		Min. 50 MΩ (500 V d.c. mega standard)	
Dielectric strength		2000 V a.c. 50/60 Hz for 1 min (between the recharging part and case)	
Vibration resistance		10 - 55 Hz (1 min cycle, double amplitude: 1.5 mm 2 hours for each of X, Y and Z directions)	
Shock resistance		500 m/s ² 3 times to each of X, Y and Z directions	
Material		Case: PBT resin, cable holder: polyester elastomer	
Weight	Cable type	Approx. 90g	Approx. 110g
	Relay connector type	Approx. 60g	Approx. 80g

Proximity Sensors

Suffix code

Model	Code						Content
UP	<input type="checkbox"/>	S -	<input type="checkbox"/>	<input type="checkbox"/>	<input type="checkbox"/>	<input type="checkbox"/>	Inductive Type Proximity Sensor
Sensing area size	12						12(W) × 12(H) mm
	18						18(W) × 18(H) mm
	25						25(W) × 25(H) mm
	30						30(W) × 30(H) mm
	40						40(W) × 40(H) mm
Structure type	S						Square type
Sensing distance	2						2 mm (only with UP8S-2)
	4						4 mm (only with UP12S-4)
	5						5 mm (only with UP18S-5, UP25S-5)
	8						8 mm (only with UP18S-8, UP25S-8)
	10						10 mm (only with UP30S-10)
	12						12 mm (only with UP25S-12)
	15						15 mm (only with UP30S-15)
	20						20 mm (only with UP40S-20)
Power and output type	N						DC NPN output
	P						DC PNP output
	A						AC 2 wire type (but UP18S is excluded)
	T						DC 2 wire type (polarity)
	U						DC 2 wire type (no polarity)
Output state	A						Normal Open (NO)
	C						Normal Close (NC)
Sensing direction	*						Detect Front side
	U						Detect upper side (only available with the square type UP18S)
Connection structure	*						Cable type
	CR						Relay connector type

UP series Flat Type Proximity Sensors

Specifications

Inductive DC 3 wire type / 2 wire type

Model	DC 3 wire type		DC 2 wire type	
	NPN	UP25F-8N□□	Polarity	UP25F-8T□□
	PNP	UP25F-8P□□	No polarity	UP25F-8U□□
Appearance				
Standard sensing object(mm)	Iron 25 X 25 X 1			
Sensing distance	8 mm			
Setting distance	0 ~ 6.4 mm			
Hysteresis	Less than 10 % of sensing distance			
Response frequency	350 Hz			
Power voltage	12 - 24 V d.c. (usable voltage range 5 - 35 V d.c.)		12 - 24 V d.c. (usable voltage range 5 - 30 V d.c.)	
Control output	Max. 200 mA (resistive load)		Max. 100 mA (resistive load)	
Residual voltage	Max. 1.5 V		Polarity: max. 3.5 V, no polarity: max. 5 V	
Current consumption	Max. 6 mA		-	
Leakage current	-		Max. 1 mA	
Operation indication	Red LED			
Protection circuit	Power reversely connected protective circuit, surge protective circuit and over current protective circuit are built-in.		Surge protective circuit and over current protective circuit are built-in.	
Ambient temperature & humidity	-25 ~ 70 °C (less than ±10 % of sensing distance at temperature 20 °C), 35 ~ 85 %RH			
Insulation resistance	Min. 50 MΩ (500 V d.c. mega standard)			
Dielectric strength	2000 V a.c. 50/60 Hz for 1 min (between the recharging part and case)			
Vibration resistance	10 - 55 Hz (1 min cycle, double amplitude: 1.5 mm 2 hours for each of X, Y and Z directions)			
Shock resistance	500 m/s ² 3 times to each of X, Y and Z directions			
Degree of protection	IP67 (IEC 60529)			
Connection structure	Cable type (standard cable length 2 m), relay connector type			
Color	Polarity: green, no polarity: purple			
Material	Case: PBT resin, cable holder: polyester elastomer			

Inductive AC 2 wire type

Model	UP25F-8A□□
Appearance	
Standard sensing object(mm)	Iron 25 X 25 X 1
Sensing distance	8 mm
Setting distance	0 ~ 6.4 mm
Hysteresis	Less than 10% of sensing distance
Response frequency	20 Hz
Power voltage	100 - 240 V a.c. (usable voltage range 90 - 250 V a.c.)
Control output	Max. 200 mA (resistive load)
Residual voltage	Max. 10 V a.c.
Leakage current	Max. 2.2 mA
Operation indication	Red LED
Protection circuit	Surge protective circuit built-in.
Ambient temperature & humidity	-25 ~ 70 °C (less than ±10 % of sensing distance at temperature 20 °C), 35 ~ 85 % RH
Insulation resistance	Min. 50 MΩ (500V d.c. mega standard)
Dielectric strength	2000 V a.c. 50/60 Hz for 1 min (between the recharging part and case)
Vibration resistance	10 - 55 Hz (1 min cycle, double amplitude: 1.5 mm 2 hours for each of X, Y and Z directions)
Shock resistance	500 m/s ² 3 times to each of X, Y and Z directions
Degree of protection	IP67 (IEC 60529)
Connection structure	Cable type (standard cable length 2 m), relay connector type
Color	NO: green, NC: purple
Material	Case: PBT resin, cable holder: polyester elastomer

Suffix code



Model	Code					Content
UP	□	F -	□	□	□	Inductive Type Proximity Sensor
Sensing area size	25					Please refer to the dimension (25.7×49.0×10.5)
Structure type		F				Flat type
Sensing distance		8				8 mm
Power and output type			N			DC NPN output
			P			DC PNP output
			A			AC 2 wire type
			T			DC 2 wire type (polarity)
			U			DC 2 wire type (no polarity)
Output state			A			Normal Open (NO)
			C			Normal Close (NC)
Connection structure			*			Cable type
			CR			Relay connector

Proximity Sensors



■ CUP series Capacitive Type Proximity Sensors

■ Specifications

■ Capacitive DC 3 wire type

Model	NPN	CUP18R-8N	CUP18RP-8N	CUP30R-15N	CUP30RP-15N
	PNP	CUP18R-8P	CUP18RP-8P	CUP30R-15P	CUP30RP-15P
Appearance					
Shield	Non shield			Non shield	
Standard sensing object(mm)	Iron 50 X 50 X 1 (Grounded <earthed> state)				
Sensing distance	8 mm (volume variation)			15 mm (volume variation)	
Setting distance	0 ~ 6.4 mm			0 ~ 12 mm	
Hysteresis	Less than 20 % of sensing distance				
Response frequency	100Hz				
Power voltage	12 - 24 V d.c. (usable voltage range 10 - 30 V d.c.)				
Control output	Max. 200 mA (resistive load)				
Residual voltage	Max. 1.5 V				
Current consumption	Max. 10 mA				
Operation indication	Red LED				
Protection circuit	Power reversely connected protective circuit, surge protective circuit and over current protective circuit are built-in.				
Ambient temperature & humidity	-25 ~ 70 °C (less than ±10 % of sensing distance at temperature 20 °C), 35 ~ 85 %RH				
Insulation resistance	Min. 50 MΩ (500 V d.c. mega standard)				
Dielectric strength	2000 V a.c. 50/60 Hz for 1 min (between the recharging part and case)				
Vibration resistance	10 - 55 Hz (1 min cycle, double amplitude: 1.5 mm 2 hours for each of X, Y and Z directions)				
Shock resistance	500 m/s ² 3 times to each of X, Y and Z directions				
Degree of protection	IP67 (IEC 60529)				
Connection structure	Cable type (standard cable length 2 m), relay connector type, connector type				
Color	NPN: green, PNP: purple				
Material	CUP-18R/CUP-30R (Case: brass chrome plating, sensing surface: PBT resin), CUP-18RP/CUP-30RP (Case and sensing surface one body type: PBT resin)				

■ Capacitive type, DC/AC dual usage 2 wire type

Model	CUP18R-8F□□	CUP18RP-8F□□	CUP30R-15F□□	CUP30RP-15F□□
Appearance				
Shield	Non shield			Non shield
Standard sensing object(mm)	Iron 50 X 50 X 1 (Grounded <earthed> state)			
Sensing distance	8 mm (volume variation)		15 mm (volume variation)	
Setting distance	0 ~ 6.4 mm		0 ~ 12 mm	
Hysteresis	Less than 20% of sensing distance			
Response frequency	DC: 100 Hz / AC: 100 Hz			
Power voltage	12 - 24 V d.c. / 110 - 220 V a.c. (usable voltage range 10 - 30 V d.c. / 90 - 250 V a.c.)			
Control output	Max. 5 - 250 mA (resistive load)			
Residual voltage	Max. 7 V (a.c./d.c.)			
Leakage current	Max. 2 mA			
Operation indication	Red LED			
Protection circuit	Surge protective circuit built-in.			
Ambient temperature & humidity	-25 ~ 70 °C (less than ±10 % of sensing distance at temperature 20 °C), 35 ~ 85 %RH			
Insulation resistance	Min. 50 MΩ (500 V d.c. mega standard)			
Dielectric strength	2000 V a.c. 50/60 Hz for 1 min (between the recharging part and case)			
Vibration resistance	10 - 55 Hz (1 min cycle, double amplitude: 1.5 mm 2 hours for each of X, Y and Z directions)			
Shock resistance	500 m/s ² 3 times to each of X, Y and Z directions			
Degree of protection	IP67 (IEC 60529)			
Connection structure	Cable type (standard cable length 2 m), relay connector type, connector type			
Case	Brass (Chrome plating)	PTB resin	Brass (Chrome plating)	PTB resin
Color	NO: green, NC: purple	NO/NC: green	NO: green, NC: purple	NO/NC: green
Material	CUP-18R/CUP-30R (Case: brass chrome plating, sensing surface: PBT resin), CUP-18RP/CUP-30RP (Case and sensing surface one body type: PBT resin)			

Suffix code







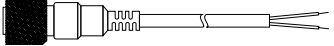

Model	Code					Information
CUP	<input type="checkbox"/>	<input type="checkbox"/>	-	<input type="checkbox"/>	<input type="checkbox"/>	Capacitive Type Proximity Sensor
Sensing area size	18					M18
	30					M30
Structure type		R				Round type (Brass chrome plating case)
		RP				Round type (Plastic case)
Sensing distance		8				8 mm(only with CUP-18□-8)
		15				15 mm(only with CUP-30□-15)
Power and output type			N			DC NPN output
			P			DC PNP output
			F			AC/DC 2 wire type (dual usage) (no polarity)
Output state			A			Normal Open (NO)
			C			Normal Close (NC)
Connection structure			*			Cable type
			CR			Relay connector type

Temperature Controllers
Recorders
Digital Counter/ Timers
Analog Timers
Multi Pulse Meters
Panel Meters
Peripheral Devices
Proximity Sensors
Photo Sensors
Rotary Encoders
Thyristor Power Regulators
Solid State Relays
Power Supplies
Control Switches, Combination Display Lights
Power / Main / Cam Switches
Limit Switches
Micro Switches
Foot / Mono Lever / Pendant Switches
Signal Lights
Power Buzzers / Terminal Blocks Fuse Holders / Control Boxes

Proximity Sensors

Connector cables

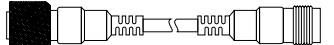
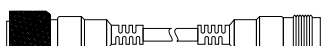
Specifications





Classification	Appearance	Model	Cable length	Usage power
Connector cable		AA2S-2M	2 m	AC 2 wire
		AA2S-5M	5 m	
		AD3S-2M	2 m	DC 3-wire
		AD3S-5M	5 m	
		AD2S-2M	2 m	DC 2 wire
		AD2S-5M	5 m	
		AA2A-2M	2 m	AC 2 wire
		AA2A-5M	5 m	
		AD3A-2M	2 m	DC 3-wire
		AD3A-5M	5 m	
		AD2A-2M	2 m	DC 2 wire
		AD2A-5M	5 m	
Relay cable		BA4S-2M	2 m	AC
		BA4S-5M	5 m	
		BD4S-2M	2 m	DC
		BD4S-5M	5 m	
		BA4A-2M	2 m	AC
		BA4A-5M	5 m	
		BD4A-2M	2 m	DC
		BD4A-5M	5 m	

Suffix code

Model	Code	Content
	<input type="checkbox"/> <input type="checkbox"/> <input type="checkbox"/> <input type="checkbox"/> - <input type="checkbox"/>	Cable for Connecting proximity sensor
Cable	A	Connector cable
	B	Relay cable
Operating Voltage	A	AC
	D	DC
Number of wires	2	2 wires
	3	3 wires
	4	4 wires
Connector type	S	Straight type
	A	Angle type
Cable length	2M	2 m
	5M	5 m

■ PB series General Purpose Photo Sensors

■ Specifications

Model	NPN	PB-T7N	PB-T10RN	PB-T15N	PB-M3RN	PB-P3RN	PB-R01N	PB-R04RN	PB-R1N	PB-D04N
	PNP	PB-T7P	PB-T10RP	PB-T15P	PB-M3RP	PB-P3RP	PB-R01P	PB-R04RP	PB-R1P	PB-D04P
Appearance										
Sensing mode	Through-beam				Retro-reflective	Retro-reflective (polarized mirror)	Diffuse - reflective			Distance-settable
Detecting object	Opaque object (over Ø12 mm)				Opaque object (over Ø75 mm)		White non-glossy paper (100 x 100 mm)			
Hysteresis	None						Max. 20% of sensing distance			
Operation mode	Light ON / Dark ON mode switching selection by VR									
Sensing distance	7 m	10 m	15 m	0.1 - 3 m (when using HY-M5) / 0.1 - 4 m (when using HY-M5S)		100 mm	400 mm	1 m	400 mm	
Response time	Max. 1 ms									
Sensitivity adjustment	VR built-in									
Power voltage	12 - 24 V d.c. ± 10 % (Ripple max. 10 %)									
Current consumption	Emitter	Max. 20 mA				Max. 30 mA				
	Receiver	Max. 15 mA								
Light source (wavelength)	Infrared LED (850 nm)	Red LED	Infrared LED (850 nm)	Red LED		Infrared LED (850 nm)	Red LED	Infrared LED (850 nm)		
Control output	Load Current: max. 100mA (26.4V d.c.) Residual voltage: max. 1 V									
Protection circuit	Power reverse protection circuit, output reverse protection circuit, output short circuit protection circuit, mutual interference prevention function (through-beam type excluded), output short circuit notification (emitter part excluded)									
LED Indicator	Red LED: operation indicator, green LED: stability indicator (however, the red LED of the emitter displays the power only)									
Insulation resistance	Min. 20 MΩ (500 V d.c. mega standard)									
Dielectric strength	1000 V a.c. 50/60 Hz for 1 min									
Vibration resistance	10 - 55 Hz, double amplitude: 1.5 mm, X·Y·Z each direction 2 hours									
Shock resistance	500 m/s ² , X·Y·Z each direction 3 times									
Ambient illumination	● Sunlight: max. 11000 lx ● Incandescent lamp: max. 3000 lx									
Ambient temperature & humidity	● During operation: -20 ~ 60 °C ● During storage: -25 ~ 70 °C, 35 ~ 85 % RH (without condensation or icing)									
Noise immunity	Square wave noise by noise simulator (pulse width 1 μs) ±240 V									
Degree of protection	IP65 (IEC 60529)									
Accessories	Bracket A, Bracket B, Bracket C									



■ Suffix code

Model	Code				Content	
PB-	□	□	□	□	General Purpose Photo Sensor	
Sensing mode and distance	T	7			7 m	Through-beam
		10			10 m	
		15			15 m	
	M	3			3 m	Retro-reflective (mirror)
		3			3 m	Retro-reflective (polarized mirror)
	R	01			0.1 m	Diffuse-reflective
		04			0.4 m	
		1			1 m	
	D	04			0.4 m	Distance-settable
Light source					Infrared (IR)	
	R				Red light	
Output	N				NPN open collector output	
	P				PNP open collector output	

Photo Sensors

■ PCS/PCF series Ultra Small / Ultra Flat Photo Sensors

■ Specifications

Model	PCS-T1NL	PCS-T1ND	PCS-R003NL	PCS-R003ND	PCF-T1NL	PCF-T1ND	PCF-R003NL	PCF-R003ND
	PCS-T1PL	PCS-T1PD	PCS-R003PL	PCS-R003PD	PCF-T1PL	PCF-T1PD	PCF-R003PL	PCF-R003PD
Appearance								
Sensing mode	Through-beam		Diffuse - reflective		Through-beam		Diffuse - reflective	
Hysteresis	-		Max. 20% of the max. sensing distance		-		Max. 20% of the max. sensing distance	
Detecting object	Opaque object (over Ø2 mm)		White non-glossy paper (50 x 50 mm)		Opaque object (over Ø2 mm)		White non-glossy paper (50 x 50 mm)	
Min. detecting object	Opaque object (over Ø2 mm)		Opaque object (over Ø0.2 mm) ※ sensing distance: 10 mm		Opaque object (over Ø2 mm)		Opaque object (over Ø0.2 mm) ※ sensing distance: 10 mm	
Operation mode	Light ON	Dark ON	Light ON	Dark ON	Light ON	Dark ON	Light ON	Dark ON
Sensing distance	1 m		5 - 30 mm		1 m		5 - 30 mm	
Response time	Max. 1 ms							
Power voltage	12 - 24 V d.c. ± 10 %							
Current consumption	Max. 20 mA (for through-beam type, corresponding to each of the emitter / receiver)							
Light source (wavelength)	Red LED (640 nm)							
Control output	NPN or PNP open collector output, load current - max. 50 mA (26.4 V d.c. standard), residual voltage - NPN: max. 1V, PNP: max. 2V							
Protection circuit	Power reverse protection circuit, output short circuit overcurrent protection circuit, output short circuit notification circuit (note 1)							
LED Indicator	Red LED: control output, green LED: stability indicator (however, the red LED of the emitter displays the power)							
Insulation resistance	Min. 20 MΩ (500 V d.c. mega standard)							
Dielectric strength	1000 V a.c. 50/60 Hz for 1 min							
Vibration resistance	10 - 55 Hz, double amplitude: 1.5 mm, X·Y·Z each direction 2 hours							
Ambient illumination	● Sunlight: max. 11000 lx ● Incandescent lamp: max. 3000 lx							
Ambient temperature & humidity	● During operation: -20 ~ 60 °C ● During storage: -25 ~ 70 °C, 35 ~ 85 % RH (without condensation)							
Noise immunity	Square wave noise by noise simulator (pulse width 1 μs) ±240 V							
Degree of protection	IP65 (IEC 60529)							
Connection	Cable extended type							

(note 1) Repeats red LED OFF for 38.4 ms after red LED turns on for 192 μs during light-on

■ Suffix code

Model	Code				Content
PCS-	□	□	□	□	Ultra Small Photo Sensor
PCF-	□	□	□	□	Ultra Flat Photo Sensor
Sensing mode	T				Through-beam
	R				Diffuse-reflective
Sensing distance	1				1m
	003				0.03m (30mm)
Control output	N				NPN open collector output
	P				PNP open collector output
Operation mode	L				Light ON
	D				Dark ON

■ PY series Flat Photo Sensors

■ Specifications

Model	NPN	PY-T3N
	PNP	PY-T3P
Appearance		
Sensing mode	Through-beam	
Detecting object	Opaque object (over Ø5 mm)	
Operation mode	Light ON / Dark ON mode switching selection by control wire (only receiver)	
Sensing distance	3 m	
Response time	Max. 1 ms	
Power voltage	12 - 24 V d.c. ± 10 %	
Current consumption	Emitter	Max. 10 mA
	Receiver	Max. 15 mA
Light source (wavelength)	Infrared LED (850 nm)	
Control output	NPN or PNP open collector output, load current - max. 100 mA (26.4 V d.c. standard), residual voltage - NPN: max. 1V, PNP: max. 1V	
Protection circuit	Power reverse protection circuit, output short circuit overcurrent protection circuit, output short circuit notification circuit (note 1), output failure notification circuit (note 2)	
LED Indicator	Red LED: Control output, green LED: stability indicator (however, the red LED of the emitter displays the power)	
Insulation resistance	Min. 20 MΩ (500 V d.c. mega standard)	
Dielectric strength	1000 V a.c. 50/60 Hz for 1 min	
Vibration resistance	10 - 55 Hz, double amplitude: 1.5 mm, X·Y·Z each direction 2 hours	
Shock resistance	500 m/s ² , X·Y·Z each direction 3 times	
Ambient illumination	● Sunlight: max. 11000 lx ● Incandescent lamp: max. 3000 lx	
Ambient temperature & humidity	● During operation: -20 ~ 60 °C ● During storage: -25 ~ 70 °C, 35 ~ 85 % RH (without condensation)	
Degree of protection	IP67 (IEC 60529)	
Materials	Case: PC, lens: PC	
Connection	Cable extended type	
Weight	Approx. 66 g	

(note 1) Repeats red LED OFF for 38.4 ms after red LED turns on for 192 μs during light-on

(note 2) Turns OFF after red LED turns ON for 49 ms during light-on



■ Suffix code

Model	Code	Content
PY -	□ □ □	Flat Photo Sensor
Sensing mode	T	Through-beam
Sensing distance	3	3 m
Output	N	NPN open collector output
	P	PNP open collector output

Photo Sensors

PN series Voltage Output Type Photo Sensors

Specifications

Model	PN-T3	PN-R02	PN-M1
Appearance			
Type	Through-beam	Diffuse-reflective	Retro-reflective
Sensing distance	3 m	200 mm	0.1-1 m
Detecting object	Opaque object (over Ø8 mm)	White non-glossy paper (200 x 200 mm)	Opaque object (over Ø48 mm)
Power voltage	12 - 24 V d.c.(± 10 %)		
Current consumption	Emitter: max. 20mA d.c. , Receiver: max. 18 mA d.c.	Max. 30 mA d.c.	
Operating mode	Dark : ON	Light : ON	Dark : ON
Control Output	NPN voltage output :Load voltage max. 30 V d.c., load current: max. 200 mA , residual voltage: max. 1 V		
Protection circuit	Reverse polarity protection, overcurrent protection		
Response time	Max. 3 ms		
Hysteresis	-	Max. 20 %	-
Light source (wavelength)	Infrared LED (850 nm)		
Sensitivity control	-	By sensitivity control volume	-
Material	Case	Polycarbonate	
	Lens	Polycarbonate	
Connection	Cable		
Ambient light	Sunlight: max. 11000 lx, incandescent light: max. 3000 lx		
Ambient temperature & humidity	-25 ~ 55 °C (surrounding storage temperature: -40~70 °C), 35 ~ 85 % RH (without condensation),		
Degree of protection	IP54 (IEC 60529)		
Vibration resistance	10 - 55 Hz, Double amplitude 1.5 mm, X·Y·Z each direction for 2 hours		
Dielectric strength	1000 V a.c. for 1 min		
Insulation resistance	Min. 20 MΩ (at 500 V d.c., between code and case, contact and power supply)		
Accessories	Bracket for fixing, bolt, nut for fixing		

(note 1) The sensing distance can be varied depending on the size, surface condition, glossy, non-glossy of the sensing object



(note 2) PN-TL3 is transmitter and PN-TR3 is receiver when it is Through-beam type

Suffix code

Model	Code	Content
PN -	<input type="checkbox"/> <input type="checkbox"/>	Photo Sensor
Sensing mode and distance	T 3	Through-beam
	M 1	Diffuse-reflective
	R 02	Retro-reflective
Operation		12 - 24 V d.c. ± 10 %

PR series Simple Installation Round Photo Sensors

Specifications

Model	Brass case	PR-T10NC	PR-T10PC	PR-M1NC	PR-M1PC	PR-M2NC	PR-M2PC	PR-R300NC	PR-R300PC
	plastic	PR-T10NP	PR-T10PP	PR-M1NP	PR-M1PP	PR-M2NP	PR-M2PP	PR-R300NP	PR-R300PP
Appearance									
Sensing mode	Through-beam			Retro-reflective			Diffuse-reflective		
Sensing distance	10 m			0.1 ~ 1 m		0.1 ~ 2 m		100 mm	300 mm
Detecting object	Opaque object (over Ø10 mm)			Opaque object (over Ø25 mm)			White non-glossy paper (200 x 200 mm)		
Power voltage	12 - 24 V d.c. ±10 %								
Current consumption	Emitter	Max. 15 mA			Max. 35 mA				
	Receiver	Max. 20 mA							
Control output	NPN, PNP open collector output, load current max. 200 mA (30 V d.c.), residual voltage: max. 1 V d.c.								
Operation mode	Light ON / Dark ON by control wire mode switching (but through-beam has only the receiver).								
Response time	Max. 1.5 ms								
Hysteresis	-							Less than ±20 % of the sensing range	
Light source (wavelength)	Infrared LED (850 nm)								
LED Indicator	Operation LED Indicator: red LED, stability LED Indicator: green LED (but the emitter red LED of through-beam is the power LED indicator)								
Sensitivity adjustment	By sensitivity adjustment volume (but through-beam has only the receiver)								
Protection circuit	Power reverse connection and output short circuit protection circuit								
Ambient illumination	● Sunlight: max. 11000 lx ● Incandescent lamp: max. 3000 lx								
Ambient temperature & humidity	-20 ~ 60 °C (During storage: -25 ~ 70 °C), 35 ~ 85 % RH (without condensation)								
Degree of protection	IP66 (IEC 60529)								
Insulation resistance	Min. 20 MΩ (500 V d.c. Mega standard)								
Dielectric strength	1000 V a.c. 50/60 Hz for 1 min								
Vibration resistance	10 - 55 Hz double amplitude: 1.5 mm, X·Y·Z each direction 2 hours								
Shock resistance	500 m/s², X·Y·Z each direction 3 times								
Connection	Cable extended type, 4P, diameter: Ø4 mm, length: 2 m (but emitter is 3P)								
Materials	Case: brass (nickel plating) / PBT, Lens: PC								
Weight	Brass case: approx. 120 g, plastic case: approx. 100 g								

- ※ Sensing distance can be varied with size, surface condition, glossy, non-glossy or others of sensing object so that consider these facts
- ※ The through-beam model is a set of PR-TL10N (emitter) , and PR-TR10N (receiver)
- ※ The sensing distance of the Retro-reflective model is the distance when using HY-M5 (reflector)



Suffix code

Model	Code				Content
PR	<input type="checkbox"/>	<input type="checkbox"/>	<input type="checkbox"/>	<input type="checkbox"/>	Round Photo Sensor
Sensing mode and distance	T	10			Through-beam 10 m
	M	1			Retro - reflective 1 m
		2			2 m
	R	100			Diffuse - reflective 100 mm
300				300 mm	
Output	N				NPN open collector output
	P				PNP open collector output
Case material	P				Plastic Case
	C				Brass case

Photo Sensors

■ PU series Fast Responding, Best Reliability

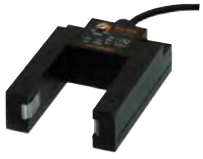
Specifications

Model	PU-30	PU-30S	PU-50	PU-50S
Appearance				
Sensing distance	30 mm		50 mm	
Detecting object	Opaque object (over Ø2 mm)	Opaque object (over Ø0.6 mm)	Opaque object (over Ø1.5 mm)	Opaque object (over Ø0.4 mm)
Power voltage	12 - 24 V d.c. ±10 %			
Current consumption	Max. 30 mA			
Operating mode	Selectable Light On/Dark On for reverse polarity			
Control Output	NPN open collector output: Load voltage max. 300 V d.c., Load current: max. 180 mA, residual voltage: max. 2 V			
Protection circuit	Reverse polarity protection , overcurrent protection			
Response time	Max.1 ms			
Light source (wavelength)	Infrared LED (940 nm)			
LED Indicator	Output: red LED, power: green LED			
Sensitivity adjustment	-	By adjusting volume	-	By adjusting volume
Material	Case	Zn		
	Lens	Polycarbonate		
Connection	Cable			
Ambient light	Sunlight: max. 11000 lx, Incandescent light: max. 3000 lx			
Ambient temperature & humidity	-25 ~ 55 °C (Surrounding Storage temperature: -40~70 °C), 35 ~ 85 % RH (without condensation)			
Degree of protection	IP65 (IEC 60529)			
Vibration resistance	10 - 55Hz, Double amplitude 1.5 mm, X·Y·Z each direction for 2 hours			
Dielectric strength	1000 V a.c. for 1 min			
Insulation resistance	Min. 20 MΩ (at 500 V d.c., between code and case, contact and power supply)			

■ PE series Power Built-In Photo Sensors

Specifications

MODEL	PE-T5D	PE-R05D	PE-M3D
Appearance			
Type	Through-beam	Diffuse-reflective	Retro-reflective
Sensing distance	5 m	500 m	0.1 m - 3 m
Detecting object	Opaque object (over 20 mm)	White non-glossy paper (200x200 mm)	Opaque object (over Ø60 mm)
Power voltage	24 - 240 V a.c. (50/60 Hz) / 24 - 240 V d.c.		
Current Consumption	Trns: max. 0.7 W Rcvr: max. 1.2 W	Max. 2 W	Max. 1.6 W
Operation mode	Dark : ON	Light: ON	Dark : ON
Control Output	Relay output 1c 250 V a.c., 2 A (resistive load)		
Response time	Max. 25 ms		
Hysteresis	-	Max. 20 %	-
Light source (wavelength)	Infrared LED (850 nm)		
LED Indicator	Power ON / OFF	Operation Indicating	
Sensitivity control	-	By sensitivity control volume	
Material	Polycarbonate		
Connection	Cable		
Ambient light	Sunlight: max. 11000 lx, Incandescent light: max. 3000 lx		
Ambient temperature & humidity	Max. -20 °C ~ 60 °C, 85 % RH		
Degree of protection	IP54 (IEC 60529)		
Vibration resistance	10 - 55 Hz, double amplitude width 1.5 mm , X·Y·Z, each direction for 2 hours		
Dielectric strength	1500 V a.c. for 1 min		
Insulation resistance	Min. 20 MΩ (at 500 V d.c., between code and case, contact and power supply)		
Accessories	Bracket for fixing, bolt Nut for fixing		

PTX series Photo Sensors

Specifications

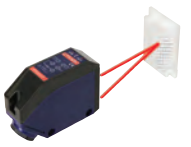
Model	Type	Normal Type	Timer Built-in Type	Normal Type	Timer Built-in Type	Normal Type	Timer Built-in Type
	Built-in Power Supply		PTX-T15A	PTX-T15A-T	PTX-M7A	PTX-M7A-T	PTX-R1A
Built-in Amplifier		PTX-T15B	PTX-T15B-T	PTX-M7B	PTX-M7B-T	PTX-R1B	PTX-R1B-T
Appearance							
Sensing Type	Through-beam		Retro-reflective		Diffuse-reflective		
Sensing distance	15 m		7 m		1 m		
Detecting object	Opaque object (over Ø20 mm)		Opaque object (over Ø60 mm)		White non-glossy paper (200x200 mm)		
Power voltage	Built-in Power Supply	24 - 240 V a.c./d.c. ±10 % 50/60 Hz					
	Built-in Amplifier	12 - 24 V d.c. (± 10 %)					
Current Consumption	Emitter	Max. 2 W		Max. 2 W			
	Transmitter	Max. 1 W					
Control Output	Built-in Power Supply	Relay contact output (Contact composition 1a, 1b), Contact capacity : 5A resistive load, rated load life expectancy less than 100,000 times.					
	Built-in Amplifier	NPN/PNP open collector yield output at the same time, Load : 150 mA, Load current: (resistive load) NPN Residual voltage: max. 1 V d.c./PNP Residual voltage: max. 2 V d.c.					
Operation mode	Light ON/Dark ON are selectable by the selector switch						
Response time	Built-in Power Supply	Max. 20 ms					
	Built-in Amplifier	Max. 1 ms					
Hysteresis	-		Less than 20 % of sensing distance				
LED Indicator	Output indication: red LED, Stability indication: green LED						
Sensitivity adjustment	Sensitivity adjusting volume built-in						
Protection circuit	Built-in Power Supply	Surge protection					
	Built-in Amplifier	Reverse polarity protection and output-circuit protection					
Timer function built-in (only corresponds to timer built-in type)	Select OFF Delay, ON Delay or One Shot Delay by using the ON/OFF switch. Delay Time: 0.1~5sec adjust by the volume.						
Ambient illumination	Sunlight: max. 11000 lx, incandescent lamp: max. 3000 lx						
Ambient temperature & humidity	Operation temperature: -20 ~ 60 °C, Storage temperature: -25 ~ 70 °C, 35 ~ 85 % RH (without icing or dew condensation)						
Degree of protection	IP66 (IEC 60529)						
Insulation resistance	Min 20MΩ (standard on 500 V d.c. mega)						
Dielectric strength	1500 V a.c. for 1 min						
Vibration resistance	10 - 55 Hz Double amplitude: 1.5 mm, 2 hours to each of X, Y, Z directions						
Shock resistance	500 m/s ² (approx. 50G), 3 times to each of X, Y, Z directions						
Connection method	Terminal						
Material	Case: ABS, Lens: PC						
Weight	Max. 80g						
Accessories	Individual	-		Reflector		-	
	Common	Driver, Bracket, bolt, Nut, Water-proof rubber, Wire holder					

(note 1) The sensing distance may vary depending on the size, surface condition, glossy, non-glossy of the sensing object

(note 2) The sensing distance of PTX-M7A (-T), PTX-M7B (-T) is the distance when using the reflector HY-M5

Suffix code

Model	Code	Content
PTX -	□ □ □ □	Photo Sensor
Sensing mode and distance	T 15	Through-beam 15 m
	M 7	Retro-reflective 7 m
	R 1	Diffuse-reflective 1 m
Power voltage	A	24 - 240 V a.c./d.c. ±10 % 50/60 Hz
	B	12 - 24 V d.c. ±10 %
Timer	-	Normal type
	-T	Timer Built-in type

Photo Sensors

■ PL-D2B Distance-Settable Photo Sensors

Specifications

Model	PL-D2B
Appearance	
Sensing method	Distance-settable
Sensing distance	0.2 ~ 2 m
Detecting object	White non-glossy paper (200x200 mm)
Power voltage	12 - 24 V d.c. ±10 %
Current consumption	Max. 30 mA
Control output	NPN / PNP open collector asynchronously, Load current: max. 150 mA d.c. (resistive load) NPN residual voltage: max. 1 V d.c., PNP residual voltage: max. 2 V d.c.
Operation mode	Light ON / Dark ON ※ Selectable by the mode V/R
Response time	Max. 2 ms.
Hysteresis	Less than 10% of the sensing distance
Light source (wavelength)	Infrared LED (880 nm)
Receiving part	2 photo diodes
LED Indicator	Control out display: red LED, Stability display: green LED
Distance setting	Near/Far: Optical distance adjusting volume 5 cycles.
Protection circuit	Reverse polarity protection and output short-circuit protection
Ambient illumination	Sunlight: max. 11000 lx, incandescent lamp: max. 3000 lx.
Ambient temperature & humidity	Operation: -20 ~ 60 °C, Storage: -25 ~ 70 °C, 35 ~ 85 % RH (without condensation)
Degree of protection	IP65 (IEC 60529)
Insulation resistance	Min. 20 MΩ. (500 V d.c. Mega)
Dielectric strength	1000 V a.c. 50/60 Hz for 1 min
Vibration resistance	10 - 55 Hz, double amplitude: 1.5mm for 2 hours each in X, Y and Z directions.
Shock resistance	500 m/s ² 3 times each in X, Y and Z directions.
Connection method	Cable output type, number of wires: 4P, thickness: Ø 4mm, length 2m
Material	Case: PC, Lens: PC
Accessory	Bracket, Adjustable driver, bolt, Nut.



Suffix code

Model	Code	Content
PL -	D 2 B	Distance-Settable Photo Sensor
Sensing mode	D	Distance-settable
Sensing distance	2	2 m
Power voltage	B	12 - 24 V d.c.

Photo Sensors

PEN series Photo Sensors

Specifications



Model	PEN-T10A		PEN-M5A		PEN-R700A	
Appearance						
Type	Through-beam		Retro-reflective		Diffuse-reflective	
Sensing distance	10 m		0.1 ~ 5 m		700 m	
Detecting object	Opaque object (over Ø20 mm)		Opaque object (over Ø60 mm)		White non-glossy paper (200x200 mm)	
Power voltage	24 - 240 V a.c./d.c. 50/60 Hz ±10 %					
Current Consumption	Trns	Max. 1 W		Max. 2 W		
	Rcvr	Max. 2 W				
Control Output	Relay output (Contact composition 1a,1b) capacity : 30 V d.c. 5 A / 250 V a.c. 5 A Resistance load life expectancy - min. 100 thousand times					
Operation mode	Light ON / Dark ON					
Response time	Less than 20 ms					
Hysteresis	-				Within 20 % of detecting distance	
Light source (wavelength)	Infrared LED (850 nm)					
Protection circuit	Reverse polarity protection and overcurrent protection					
Connection	Length of code: 1.5 M 5P Ø6 mm, Trns: 2P (Built-in power supply : 4P Ø4 mm, Trns: 2P)					
Ambient light	Sunlight: less than 11000 lx, incandescent lamp: less than 3000 lx					
Ambient temperature	Operation: -20 ~ 60 °C (storage: -25 ~ 70 °C)					
Degree of protection	IP64 (IEC 60529)					
Vibration resistance	10 - 55 Hz, double amplitude width 1.5 mm , X·Y·Z, each direction for 2 hours					
Dielectric strength	1500 V a.c. for 1 min					
Insulation resistance	500 mΩ, X.Y.Z each direction 3 times					
Material	Case: Heatproof ABS, Lens: PC					
Insulation resistance	More than 20 MΩ (at 500V d.c. between code and case, adjusting switch and case)					
Weight	150 g (Built-in Power Supply), 100 g (Built-in Amplifier)					

Suffix code

Model	Code			Content	
PEN -	<input type="checkbox"/>	<input type="checkbox"/>	<input type="checkbox"/>	Photo Sensor	
Sensing mode and distance	T	10		Through-beam	10 m
	M	5		Retro-reflective	0.1 - 5 m
	R	700		Diffuse-reflective	700 mm
Power voltage	A	24 - 240 V a.c./d.c. 50/60 Hz ±10 %			

PG series Fiber Optic Sensors

Specifications

		Universal type	Multi type (Stable output)
Appearance			
Model	NPN	PG-TRN	PG-TARN
	PNP	PG-TRP	PG-TARP
Function		Change OFF Delay, ON Delay by switch Delay Time: 40 ms	Change OFF Delay, ON Delay, One Shot Delay by switch Delay Time: 0.1 ~ 5 sec. (adjustable by volume)
Sensing method		Through-beam type, diffuse-reflective type (decision by combined with fiber unit)	
Sensing distance		Decision by combined with fiber unit	
Power voltage		12 - 24 V d.c. ±10 %	
Current consumption		Max. 35 mA	
Output	Control	NPN/PNP Voltage output , load voltage: max. 200 mA (30 V d.c.), residual voltage: max. 1 V d.c.	
	Stability	-	NPN/PNP Voltage output Load voltage: max. 50 mA (30 V d.c.) Residual voltage: max. 1 V d.c.
Operation mode		Light ON / Dark ON switch selection operating Normal or ON/OFF delay Switch selection operating	
Response time		Max. 1 ms	
Hysteresis		Max. 10 % of sensing distance (Reflection)	
Light source (wavelength)		Red LED (630 nm)	
LED Indicator		Control output indicator: red LED, Stability indicator: green LED	
Sensitivity adjustment		Built-in the sensitivity control V/R	
Protection circuit		Reverse polarity protection, overcurrent protection (except for stable output of multi-function type)	
Ambient illumination		Sunlight: max. 11000 lx, incandescent lamp: max. 3000 lx	
Ambient temperature & humidity		Operating: -20 ~ 60 °C, preserving: -25 ~ 70 °C, 35 ~ 85 % RH (without condensation)	
Degree of protection		IP40 (IEC 60529)	
Insulating resistance		Min. 20 MΩ (500 V d.c. Mega standard)	
Dielectric strength		1000 V a.c. 50/60 Hz for 1 min	
Vibration resistance		10 - 55 Hz double amplitude 1.5mm, X,Y,Z each direction for 2 hours	
Shock resistance		500 m/s ² X,Y,Z each direction for 2 times	
Connection method		Cable extended type (Number of wire: 3P, Diameter ø4, length 2 m)	Cable extended type (Number of wire: 4P, Diameter ø4, length 2 m)
Weight		Approx. 120 g	

Suffix code

Model	Code	Content
PG -	<input type="checkbox"/> <input type="checkbox"/>	Fiber Optic Sensor
Sensing mode and distance	TR	Universal type
	TAR	Multi type (stable output)
Output	N	NPN open collector output
	P	PNP open collector output

Temperature Controllers

Recorders

Digital Counter/
TimersAnalog
TimersMulti Pulse
MetersPanel
MetersPeripheral
DevicesProximity
SensorsPhoto
SensorsRotary
EncodersThyristor
Power
RegulatorsSolid
State
RelaysPower
SuppliesControl Switches,
Combination
Display LightsPower / Main /
Cam SwitchesLimit
SwitchesMicro
SwitchesFoot /
Mono Lever /
Pendant Switches

Signal Lights

Power Buzzers /
Terminal Blocks
Fuse Holders /
Control Boxes

Photo Sensors

■ PFD series Digital Multi Control Type

Specifications

Appearance		Digital Multi Control Type	
			
Type		General purpose	Multi function
Model	NPN	PFD-RGN	PFD-RMN
	PNP	PFD-RGP	PFD-RMP
Power voltage		12 - 24 V d.c. ±10 % (Ripple max. 10 %)	
Current consumption		Max. 30 mA	
Output	Control	Open collector output, 100 mA (supplied voltage max. 30 V, residual voltage max. 0.5 V)	
	Stability	Open collector output, 100 mA (supplied voltage max. 30 V, residual voltage max. 0.5 V)	
External input		Teaching / Auto teaching	Teaching / Auto teaching / Reset input
Operating mode		Light On / Dark On output Normal output, ON DELAY, OFF DELAY, ON/OFF DELAY output	
On/Off Delay		0 ~ 9999 ms	
Light source (wavelength)		Red LED (660 nm)	
Protection circuit		Reverse polarity protection, overcurrent protection	
Response time		Max. 700 μs	
LED indicator		7 points status LED, 4 Digits FND	
Sensitivity control		Auto-teaching, Manual	
Additional function		Brightness control 180 ° Turning indication Display time set, Zero Reset, Initial reset, Lock function	
Ambient light		Incandescent Light: max. 10,000 lx	
Ambient temperature & humidity		Operating: -20 ~ 60 °C, preserving: -25 ~ 70 °C, 35 ~ 85 % RH (without condensation)	
Vibration resistance		10 - 55 Hz for 1 min, double amplitude: 1.5 mm, X·Y·Z each direction for 2 hours	
Shock resistance		1000 m/s ² (About 50 G), X·Y·Z each direction for 3 times	
Dielectric strength		1500 V a.c. 50/60 Hz for 1 min	
Insulation Resistance		Min. 20 MΩ (at 500 V d.c.)	
Connection		For DIN Rail attachment Flying lead 1.5 m 5 P	

·MODEL : PFD-RMN only

Multi function	Counter	UP / DOWN Mode, Prescale 1 ~ 1000 integers setting Output mode: 8 kinds selectable (N, F, C, R, K, P, Q, A)	Indicating range: 0 ~ 9999 External reset: Min. Signal width 5 ms	Counting speed : 400 cps
	RPM	Indicating range: 0 ~ 9999 rpm	Speed monitoring output function	Prescale: 1~1000 integers setting Measurement cycle setting
Option	Communication	RS485 or RS232 (TTL Level), No external output when using communication		

Suffix code

Model	Code	Content
PFD -	<input type="checkbox"/> <input type="checkbox"/> <input type="checkbox"/>	10 Bit A/D, 4 Digit Display
Light source	R	Red LED
Use	G	General purpose (MARK)
	M	Multi type (MARK / RPM / Counter)
External output	N	NPN open collector
	P	PNP open collector

■ PFB series Bar Indication Type

■ Specifications

		Bar Indication Type
Appearance		
Type		General purpose
Model	NPN	PFB-RN
	PNP	PFB-RP
Power voltage		12 - 24 V d.c. ±10 % (ripple max. 10 %)
Current consumption		Max. 20 mA
Output	Control	Open collector output, 100 mA (supplied voltage max. 30 V, residual voltage max. 0.5 V)
	Stability	Open collector output, 100 mA (supplied voltage max. 30 V, residual voltage max. 0.5 V)
External input		Auto teaching
Operating mode		Normal output, ON DELAY, OFF DELAY output
On/Off Delay		10, 40 ms
Light source (wavelength)		Red LED (660 nm)
Protection circuit		Reverse polarity protection, overcurrent protection
Response time		1 ms
LED indicator		6 Points bar
Sensitivity control		Auto-teaching
Ambient light		Incandescent Light: max. 11000 / 3000 lx
Ambient temperature & humidity		Operating: -20 ~ 60 °C, preserving: -25 ~ 70 °C, 35 ~ 85 % RH (without condensation)
Vibration resistance		10 - 55 Hz for 1 min, double amplitude: 1.5 mm, X·Y·Z each direction for 2 hours
Shock resistance		500 m/s ² (About 50 G), X·Y·Z each direction for 3 times
Dielectric strength		1000 V a.c. 50/60 Hz for 1 min
Insulation Resistance		Min. 20 MΩ (at 500 V d.c.)
Connection		For DIN Rail attachment Flying lead 1.5 m
		5 P

■ Suffix code

Model	Code	Content
PFB -	<input type="checkbox"/> <input type="checkbox"/>	10 Bit A/D, Bar Display
Light source	R	Red LED
External output	N	NPN open collector
	P	PNP open collector

Temperature Controllers
Recorders
Digital Counter/ Timers
Analog Timers
Multi Pulse Meters
Panel Meters
Peripheral Devices
Proximity Sensors
Photo Sensors
Rotary Encoders
Thyristor Power Regulators
Solid State Relays
Power Supplies
Control Switches, Combination Display Lights
Power / Main / Cam Switches
Limit Switches
Micro Switches
Foot / Mono Lever / Pendant Switches
Signal Lights
Power Buzzers / Terminal Blocks Fuse Holders / Control Boxes

Photo Sensors

PAS series Area Sensors

Specifications

Model	NPN	PAS-T4N	PAS-T8N	PAS-T12N	PAS-T16N	PAS-T20N
	PNP	PAS-T4P	PAS-T8P	PAS-T12P	PAS-T16P	PAS-T20P
Appearance						
Type	Through-beam					
Sensing distance	5 m					
Detecting object	Opaque object (over Ø30 mm)					
Optical axis pitch	20 mm					
Number of optical axis	4	8	12	16	20	
Sensing range	60 mm	140 mm	220 mm	300 mm	380 mm	
Power voltage	12 - 24 V d.c. ±10 %					
Current Consumption	Max. 80 mA	Max. 90 mA	Max. 100 mA	Max. 110 mA	Max. 120 mA	
Output range	NPN open collector output-Load current: max. 100 mA, load voltage: max. 30 V d.c., residual voltage: max. 1 V PNP open collector output-Load current: max. 100 mA, output voltage: (power voltage-over 2.5 V)					
Operating mode	Light ON					
Response time	Below 7 ms					
Light source (wavelength)	Infrared LED (850 nm)					
Point angle	Within ±5 ° (at over 2 m sensing distance)					
LED Indicator	Trns.: M/S display: red LED, power display: green LED, operation display: red LED Rcvr.E1 display: red LED, E2 display: blue, red, Light on stability display: green LED, operation display: red LED					
Ambient light	Sunlight: 11000 / 3000 lx					
Ambient temperature & humidity	Operating: -20 ~ 60 °C, preserving: -25 ~ 70 °C, 35 ~ 85 % RH (without condensation)					
Vibration resistance	0 - 55 Hz (cycle for 1 min) Double amplitude width 1.5 mm, each X·Y·Z direction for 2 hr.					
Degree of protection	IP40 (IEC 60529)					
Dielectric strength	1000 V a.c. for 1 min (between current part and case)					
Material	Case: ABS, Window : Acryl					
Connection	Flying lead 5P, Ø4.3 length 3 m					
Weight	Each max.160 g	Each max.180 g	Each max.200 g	Each max.220 g	Each max.240 g	
Protection function/circuit	Auto sensitivity compensation, Mutual interference prevention in parallel installation (M/S mode), Reverse polarity protection, overcurrent protection					

Suffix code

Model	Code	Content
PAS -	<input type="checkbox"/> <input type="checkbox"/> <input type="checkbox"/>	Area Sensor
Sensing mode	T	Through-beam
Number of optical axis	4	4 optical axis
	8	8 optical axis
	12	12 optical axis
	16	16 optical axis
	20	20 optical axis
Control output	N	NPN open collector
	P	PNP open collector

PAN series Highly Reliable Optical Area Sensor With An Exclusive IC

Specifications

Model	PAN20-T□□N, PAN20-T□□P	PAN40-T□□N, PAN40-T□□P
Appearance		
Type	Through-beam	
Sensing distance	7 m	
Detecting object	Opaque object (over Ø32 mm)	Opaque object (over Ø52 mm)
Optical axis pitch	20 mm	40 mm
Power voltage	12 - 24 V d.c. ±10 % (Ripple P-P ± 10 %)	
Current Consumption	Max. 170 mA	Max. 100 mA
Output Control	Light ON	
LED Indicator	Trns.M/S display: red LED, power display: green L(+) Rcvr. E1 display: red LED, E2 display: blue LED Stability display: green LED, operation display: red LED	
Response time	Max. 15 ms	Max. 7 ms
Wavelength	Infrared LED (850 nm)	
Operating indicator	Trns.: M/S display: red LED, power display: LED, operation display: Red, Rcvr.: E1 display: green LED, E2 display: Red, Light on stability display: green LED, operation display: red LED	
Operating S/W	ALL/ONE S/W Operation (only for Rcvr.), max.ter/Slave S/W Operation (only for Trns.)	
Ambient light	Sunlight: max. 11000 lx, Incandescent light: max. 3000 lx	
Ambient temperature & humidity	Operating: -20 ~ 60 °C, Preserving: -25 ~ 70 °C, Max. 35 ~ 85 % RH (without condensation)	
Vibration resistance	10 - 55 Hz (cycle for 1 min) Double amplitude width 1.5 mm, each X·Y·Z direction for 2 hr.	
Degree of protection	IP65 (IEC 60529)	
Dielectric strength	1000 V a.c. for 1 min (between current part and case)	
Material	Case: Aluminum, Window : acryl, Lens: acryl	
Connection	Connector flying lead 4P Ø5.5	
Protection function/circuit	Mutual interference prevention when parallel installation (M/S mode), Reverse polarity protection, overcurrent protection	

Production formation

Series	Model	Sensing distance	Number of optical axes	Sensing range	Detecting object
PAN20	PAN20-T8	7 m	8EA	140 mm	Opaque object of over Ø32 mm
	PAN20-T12		12EA	220 mm	
	PAN20-T16		16EA	300 mm	
	PAN20-T20		20EA	380 mm	
	PAN20-T24		24EA	460 mm	
	PAN20-T28		28EA	540 mm	
	PAN20-T32		32EA	620 mm	
	PAN20-T36		36EA	700 mm	
	PAN20-T40		40EA	780 mm	
	PAN20-T44		44EA	860 mm	
	PAN20-T48		48EA	940 mm	
PAN40	PAN40-T4	7 m	4EA	120 mm	Opaque object of over Ø57 mm
	PAN40-T6		6EA	200 mm	
	PAN40-T8		8EA	280 mm	
	PAN40-T10		10EA	360 mm	
	PAN40-T12		12EA	440 mm	
	PAN40-T14		14EA	520 mm	
	PAN40-T16		16EA	600 mm	
	PAN40-T18		18EA	680 mm	
	PAN40-T20		20EA	760 mm	
	PAN40-T22		22EA	840 mm	
	PAN40-T24		24EA	920 mm	

Suffix code

Model	Code	Content
PAN-	<input type="checkbox"/> <input type="checkbox"/> <input type="checkbox"/> <input type="checkbox"/>	Area Sensor
Optical axis pitch	20	20 mm gap
	40	40 mm gap
Sensing method	T	Through-beam
Number of optical axis	<input type="checkbox"/>	Number of optical axis (please refer to the dimension)
Output	N	NPN open collector
	P	PNP open collector

Photo Sensors

■ HPAN series Sensor Controllers

Specifications

Model	HPAN-C7	HPAN-CT7	HPAN-C7W
Appearance	 38.5×82.1×80.8		
Function	Multi-purpose	Timer function	Two sensors connectable
How to attach	DIN Rail		
Power Voltage	100 - 240 V a.c. 50/60 Hz		
Power consumption	Approx. 5 VA		
Power supply to sensor	+12 V d.c. (±10 %), max. 200 mA		
Connectable sensor	NPN / PNP transistor output or relay output sensor		
Output	<ul style="list-style-type: none"> · Relay contact: 1c (250 V a.c. 3 A, Resistive load) · Rated electrical life: over 100,000 operation · NPN transistor output (open collector) Max. sink current: 100 mA, Applied voltage: max. 30 V d.c. 		<ul style="list-style-type: none"> · Relay contact: 1c (2outs separately) (250 V a.c. 3A resistive load) Rated electrical life: over 100,000 operations (in power off)
Response time	Relay contact: approx. 10 ms, open collector: max. 5 μs		Approx. 10 ms
External synchronization	Gate synchronization	Frequency and differential synchronization	-
Timer	-	<ul style="list-style-type: none"> · Selectable from on-delay, off-delay and one shot-delay · Time range 40 ms~1 S ↔ 0.4~10 S (selectable by dip switch) 	-
Ambient temperature & humidity	-25 ~ 70 °C, 35 - 85 % RH (without condensation)		
Noise immunity	Power line: 2000 VP, 0.5 μs pulse width (by noise simulation)		
Dielectric strength	1500 V a.c. for 1 min (between supply and output)		
Insulation resistance	20 MΩ (at 500 V d.c., between supply and output)		
Vibration resistance	10 - 55 Hz (for a minute), double amplitude width 1.5 mm, each X·Y·Z direction for 2 hour (in power off)		
Shock resistance	100 m/s ² (Approx. 10 G), each X·Y·Z, 2 direction (in power off)		
Net-Weight	Approx. 150 g	Approx. 160 g	Approx. 165 g



■ HPA-12 Sensor Controllers

Specifications

Model	HPA-12
Appearance	 49.0×61.0×90.0
Function	Multi-purpose
How to attach	Relay Socket 8PIN
Power Voltage	220 V a.c. ±10 % 60 Hz
Power consumption	Approx. 4 VA
Power supply to sensor	12 V d.c. ±10 % 50 mA
Connectable sensor	NPN, PNP transistor output
Output	· Relay contact: 1c (250 V a.c. 3 A, resistive load) Rated electrical life: over 100,000 operations (in power off)
Response time	Approx. 10 ms
Ambient temperature & humidity	-20 ~ 60 °C, 25 ~ 70 % RH (No freezing or Without condensation)
Noise immunity	Power line: 2000 VP, 0.5 μs pulse width (by noise simulation)
Dielectric strength	1500 V a.c. for 1 min (between supply and output)
Insulation resistance	20 MΩ (at 500 V d.c., between supply and output)
Vibration resistance	10 - 55 Hz (for a minute), double amplitude width 1.5 mm, each X·Y·Z direction for 2 hour (in power off)
Shock resistance	100 m/s ² (Approx. 10 G), each X·Y·Z, 2 direction (in power off)
Net-Weight	Approx. 260 g

HE30B, HE40B, HE50B series Shaft Rotary Encoders

Specifications

Model		HE30B	HE40B	HE50B	
Appearance					
Electrical specifications	Output phase difference	Phase difference between the phase A and B : T/4 ± T/8 (1 cycle of A phase=T)			
	Response speed	Max. 200 kHz			
	Rated voltage	Voltage output	※ By suffix code 5 - 12 V d.c. ±5 % 12 - 24 V d.c. ±5 %		
		Open collector			
		Totem pole output			
		Line driver output	5 V d.c. ±5 %	5 / 12 / 24 V d.c. ±5 %	
	Current consumption	Max. 60 mA (no load)			
	Connection	Cable extended type			
	Control output	NPN voltage output	Load voltage: max. 30 V, load current: max. 30 mA, residual voltage: max. 0.4 V		
		NPN open collector			
Totem pole output		LOW (load current: max. 30 mA, residual voltage: max. 0.4 V d.c.) HIGH (load current: max. 10 mA, output voltage: above rated voltage -2.5 V)			
Line driver output		LOW (load current: max. 20 mA, residual voltage: max. 0.4 V) HIGH (load current: max. 20 mA, residual voltage: min. 2.5V)			
Response time	Voltage output	Max. 1 μs (wire length: 1.5 m, sinking current= max. 30 mA)			
	Open collector				
	Totem pole output	Max. 1 μs (wire length: 1.5 m, sinking current= max. 10 mA)			
	Line driver output	Max. 1 μs (wire length: 1.5 m, sinking current= max. 30 mA)			
Mechanical specifications	Starting torque	2×10 ⁻³ N·m	4×10 ⁻³ N·m	7×10 ⁻³ N·m	
	Moment of inertia	Max 2 × 10 ⁻⁶ kg·m ²	Max. 4 × 10 ⁻⁶ kg·m ²	Max. 8 × 10 ⁻⁶ kg·m ²	
	Permissible shaft loading	Radial: within 15 N Thrust: within 10 N	Radial: within 30 N Thrust: within 20 N	Radial: within 50 N Thrust: within 30 N	
	Max. number of revolutions	5000 r/min			
Ambient specifications	Insulation resistance	Min. 100 MΩ (between the terminal and case 500 V d.c. mega standard)			
	Dielectric strength	800 V a.c. 60 Hz for 1 min (between the terminal and case)			
	Vibration resistance	10 - 55 Hz (cycle for 1 min), double amplitude: 1.5 mm, for 2 hours each in X, Y and Z directions			
	Shock resistance	Max. 490 m/s ²		Max. 735 m/s ²	
	Ambient temperature & humidity	-10 ~ 70 °C, 35 ~ 85 % RH (without condensation), during storage: -25 ~ 85 °C			
	Cable	5P, Ø5.0 mm, length: 1.5 m, shield cable (HE40B, HE50B specifications: 2m, 8m, 10 m) (Line driver type: 8P, Ø5.0 mm, length: 1.5 m, shield cable)			
	Accessories	Ø 4.0 mm coupling	Ø 6.0 mm / Ø 8.0 mm coupling	Ø 8.0 mm coupling, bracket	
Weight	Approx. 120 g	Approx. 170 g	Approx. 200 g		

Suffix code (Note) 「*」 is output only for A, B phase (line driver output: A, \bar{A} , B, \bar{B} phase). Pulses other than the ones in the chart are order-made

Model	Code					Content
HE	<input type="checkbox"/>	<input type="checkbox"/>	<input type="checkbox"/>	<input type="checkbox"/>	<input type="checkbox"/>	Shaft Rotary Encoder (incremental)
Appearance	30B	4				Outer diameter: Ø 30 mm axis: Ø 4 mm
	40B	6				Outer diameter: Ø 40 mm axis: Ø 6 mm
		8				Outer diameter: Ø 40 mm axis: Ø 8 mm Option: (Option)
	50B	8				Outer diameter: Ø 50 mm axis: Ø 8 mm
Number of pulses	*					Refer to "Number of pulses (resolution)"
Output signal	2					A, B phase output
	3					A, B, Z phase output
	3C					A, B, \bar{Z} phase output
	4					A, \bar{A} , B, \bar{B} phase output
	6					A, \bar{A} , B, \bar{B} , Z, \bar{Z} phase output
Output circuit	N	12	NPN voltage output (5 - 12 V d.c.)			
		24	NPN voltage output (12 - 24 V d.c.)			
		12	NPN open collector output (5 - 12 V d.c.)			
		24	NPN open collector output (12 - 24 V d.c.)			
	T	12	Totem pole output (5 - 12 V d.c.)			
		24	Totem pole output (12 - 24 V d.c.)			
	L	5	Line driver Output (5 V d.c.)			
		12	Line driver Output (12 V d.c.)			
	24	Line driver Output (24 V d.c.)				

Number of pulses (resolution)

Please contact us if you have any request for pulse production

Model	Number of pulses per revolution
HE30B	100, 200, 360, 500, 1000, 1024
HE40B / HE50B	*1, *2, *5, 10, *12, 15, 20, 25, 30, 40, 45, 50, 60, 75, 100, 120, 125, 150, 192, 200, 240, 250, 256, 300, 360, 400, 500, 512, 600, 800, 1000, 1024

Rotary Encoders

HE40H series Hollow Shaft Rotary Encoders

Specifications

Model		HE40H	
Appearance			
Electrical specifications	Output phase difference	Phase difference between the phase A and B : $T/4 \pm T/8$ (1 cycle of A phase=T)	
	Response speed	Max. 200 kHz.	
	Rated voltage	Voltage output	※ By suffix code
		Open collector	5 - 12 V d.c. $\pm 5\%$
		Totem pole output	12 - 24 V d.c. $\pm 5\%$
		Line driver	5 V d.c. $\pm 5\%$
	Current consumption	Max. 60 mA (no load), line driver output max. 50 mA (no load)	
	Connection	Cable extended type	
	Control output	NPN voltage output	Load voltage: max. 30 V, load current: max. 30 mA, residual voltage: max. 0.4 V
		NPN open collector	
		Totem pole output	LOW (load current: max. 30 mA, residual voltage: max. 0.4 V) HIGH (load current: max. 10 mA, output voltage: above rated voltage - 2.5 V)
		Line driver output	LOW (load current: max. 20 mA, max. 0.4 V) HIGH (load current: max. 20 mA, residual voltage: min. 2.5V)
	Response time	Voltage output	Max. 1 μ s (wire length: 1.5 m, sinking current= 30 mA)
		Open collector	
Totem pole output		Max. 1 μ s (wire length: 1.5 m, sinking current= max. 10 mA.)	
Line driver output		Max. 1 μ s (wire length: 1.5 m, sinking current= max. 30 mA)	
Mechanical specifications	Starting torque	4×10^{-3} N.m	
	Moment of inertia	Max. 4×10^{-6} g·cm ²	
	Permissible shaft loading	Radial: within 30 N Thrust: within 20 N	
	Max. number of revolutions	5000 r/min	
Ambient specifications	Insulation resistance	Min. 100 M Ω (between the terminal and case 500 V d.c. mega standard)	
	Dielectric strength	800 V a.c. 60 Hz for 1 min (between the terminal and case)	
	Vibration resistance	10 - 55 Hz (cycle for 1 min), double amplitude: 1.5 mm, for 2 hours each in X, Y and Z directions	
	Shock resistance	Max. 490 m/s ²	
	Ambient temperature & humidity	-10 ~ 70 °C (without icing), during storage: -25 ~ 85 °C, 35 ~ 85 % RH	
	Cable	5 P, $\varnothing 5.0$ mm, length: 1.5 m, shield cable (HE40H cable length option: 2 m, 8 m, 10 m) (Line drive type: 8P, $\varnothing 5.0$ mm, length: 1.5 m, shield cable)	
Weight	Approx. 170 g		

Suffix code (Note) [*], Is output only for A, B phase (line driver output: A, \bar{A} , B, \bar{B} phase). Pulses other than the ones in the chart are order-made

Model	Code	Content	
HE	<input type="checkbox"/> <input type="checkbox"/> <input type="checkbox"/> <input type="checkbox"/> <input type="checkbox"/> <input type="checkbox"/>	Hollow Shaft Rotary Encoder (incremental)	
Dimension	40H	6	Outer diameter: $\varnothing 40$ mm axis inner diameter: $\varnothing 6$ mm
	8	Outer diameter: $\varnothing 40$ mm axis inner diameter: $\varnothing 8$ mm	
	10	Outer diameter: $\varnothing 40$ mm axis inner diameter: $\varnothing 10$ mm	
	12	Outer diameter: $\varnothing 40$ mm axis inner diameter: $\varnothing 12$ mm	
Number of pulse	*	Refer to the pulse code chart (resolving power)	
Output signal (output phase)	2	A, B phase output	
	3	A, B, Z phase output	
	3C	A, B, \bar{Z} phase output	
	4	A, \bar{A} , B, \bar{B} phase output	
	6	A, \bar{A} , B, \bar{B} , Z, \bar{Z} phase output	
Output circuit	N	12	NPN voltage output (5 - 12 V d.c.)
		24	NPN voltage output (12 - 24 V d.c.)
	O	12	NPN open collector output (5 - 12 V d.c.)
		24	NPN open collector output (12 - 24 V d.c.)
	T	12	Totem pole output (5 - 12 V d.c.)
		24	Totem pole output (12 - 24 V d.c.)
L	Line driver output (5 V d.c.)		

Number of pulses (resolution)

Model	Number of pulses per revolution
HE40H	*1, *2, *5, 10, *12, 15, 20, 25, 30, 40, 45, 50, 60, 75, 100, 120, 125, 150, 192, 200, 240, 250, 256, 300, 360, 400, 500, 512, 600, 800, 1000, 1024,

Please contact us if you have any request for pulse production

HE40HB series Blind Shaft Type Rotary Encoders

Specifications

Model		HE40HB		
Appearance				
Electrical specifications	Output phase difference	Phase difference between the phase A and B : T/4 ± T/8 (1 cycle of A phase=T)		
	Response speed	Max. 200 kHz		
	Rated voltage	Voltage output	※ By suffix code	
		Open collector	5 - 12 V d.c. ±5 %	
		Totem pole output	12 - 24 V d.c. ±5 %	
		Line driver output	5 / 12 / 24 V d.c. ±5 %	
	Current consumption	Max. 60 mA, line driver output max. 30 mA (no load)		
	Connection	Cable extended type		
	Control output	NPN voltage output	Load voltage: max. 30 V, load current: max. 30 mA, residual voltage: max. 0.4 V	
		NPN open collector		
		Totem pole output	LOW (load current: max. 30mA residual voltage: max. 0.4V) HIGH (load current: max. 10mA, output voltage: above rated voltage - 2.5 V d.c.)	
		Line driver output	LOW (load current: max. 20 mA, residual voltage: max. 0.4 V d.c.) HIGH (load current: max. 20 mA, residual voltage: min. 2.5V d.c.)	
	Response time	Voltage output	Max. 1 μs (wire length: 1.5 m, sinking current= max. 30 mA)	
		Open collector		
Totem pole output		Max. 1 μs (wire length 1.5 m, sinking current= max. 10 mA.)		
Line driver output		Max. 1 μs (wire length: 1.5 m, sinking current= max. 30 mA)		
Mechanical specifications	Starting torque	4×10 ⁻³ N.m		
	Moment of inertia	Max. 4×10 ⁻⁶ Kg·m ²		
	Permissible shaft loading	Radial: within 30 N, thrust: within 20 N		
	Max. number of revolutions	5000 r/min		
Ambient specifications	Insulation resistance	Min. 100 MΩ (between the terminal and case 500 V d.c. mega standard)		
	Dielectric strength	800 V a.c. 60 Hz for 1 min (between the terminal and case)		
	Vibration resistance	10 - 55 Hz (cycle for 1 min), double amplitude: 1.5 mm, for 2 hours each in X, Y and Z directions		
	Shock resistance	Max. 735 m/s ²		
	Ambient temperature & humidity	-10 ~ 70 °C (without condensation), during storage: -25 ~ 85 °C, 35 ~ 85 % RH		
	Cable	5 P, Ø 5 mm, length: 1.5 m, shield cable (Line driver type: 8P, Ø 5 mm, length: 1.5 m, shield cable)		
	Accessories	Bracket		
Weight	Approx. 170g			

Suffix code

(Note) *_, Is output only for A, B phase (line driver output: A, \bar{A} , B, \bar{B} phase). Pulses other than the ones in the chart are order-made

Model	Code					Content
HE	<input type="checkbox"/>	<input type="checkbox"/>	<input type="checkbox"/>	<input type="checkbox"/>	<input type="checkbox"/>	Blind Shaft Type Rotary Encoder (Incremental)
40HB		6				Outer diameter: Ø40 mm inner diameter: Ø6 mm
		8				Outer diameter: Ø40 mm inner diameter: Ø8 mm
		10				Outer diameter: Ø40 mm inner diameter: Ø10 mm
		12				Outer diameter: Ø40 mm inner diameter: Ø12 mm
Number of pulses		*				Refer to "Number of pulses (resolution)"
Output signal (Output phase)			2			A, B phase output
			3			A, B, Z phase output
			3C			A, B, \bar{Z} phase output
			4			A, \bar{A} , B, \bar{B} phase output
			6			A, \bar{A} , B, \bar{B} , Z, \bar{Z} phase output
Output circuit	N	24				NPN voltage output (12 - 24 V d.c.)
		12				NPN voltage output (5 - 12 V d.c.)
		24				NPN open collector output (12 - 24 V d.c.)
		12				NPN open collector output (5 - 12 V d.c.)
	T	24				Totem pole output (12 - 24 V d.c.)
		12				Totem pole output (5 - 12 V d.c.)
	L	5				Line driver Output (5 V d.c.)
		12				Line driver Output (12 V d.c.)
		24			Line driver Output (24 V d.c.)	

Number of pulses (resolution)

Please contact us if you have any request for pulse production

Model	Number of pulses per revolution
HE40HB	*1, *2, *5, 10, *12, 15, 20, 25, 30, 40, 45, 50, 60, 75, 100, 120, 125, 150, 192, 200, 240, 250, 256, 300, 360, 400, 500, 512, 600, 800, 1000, 1024

Rotary Encoders

■ PSC series Wheel Type Encoders

■ Specifications

Model		PSC	
Appearance			
Electrical specification	Output phase difference	Phase difference between the phase A and B : $T/4 \pm T/8$ (1 cycle of A phase=T)	
	Response speed	Max. 100 KHz	
	Rated voltage	5 - 12 V d.c. ($\pm 5\%$), 12 - 24 V d.c. ($\pm 5\%$)	
	Current consumption	Max. 60 mA	
	Connection	Cable extended type	
	Control output	Voltage and open collector outputs	Load voltage: max. 30 V, load current: max. 30 mA, residual voltage: max. 0.4 V
		Totem pole output	LOW (load current: max. 30 mA, residual voltage: max. 0.4 V) HIGH (load current: max. 10 mA, output voltage: above rated voltage - 1.5 V d.c.)
Response time	Max. 1 μ s (wire length: 1.5 m, sinking current= 30 mA)		
Mechanical specification	Starting torque	Max. 200 gf·cm (19.600 u N·m)	
	Moment of inertia	Max. 800 g·cm ² (8×10^{-6} kg·m ²)	
	Permissible shaft loading	Radial: within 0.1 mm, thrust: within 0.2 mm	
	Max. number of revolutions	5000 r/min	
	Bearing life	1.2 X 10 ⁷ (r/min): time	
Ambient specifications	Insulation resistance	Min. 500 M Ω (between the terminal and case)	
	Dielectric strength	500 V a.c. 60 Hz for 1 min (between the terminal and case)	
	Vibration resistance	10 - 55 Hz (cycle for 1 min), double amplitude: 1.5 mm, for 2 hours each in X, Y and Z directions	
	Shock resistance	Max. 75 G	
	Ambient temperature & humidity	-10 ~ 70 °C (without icing), during storage: -25 ~ 85 °C, 35 ~ 85 % RH	
	Cable	Number of strips: 5 P, thickness: \varnothing 5.0 mm, length: 1.5 m, shield cable	
	Weight	Approx. 625 g	

■ Suffix code



Model	Code	Content
PSC-	<input type="checkbox"/> <input type="checkbox"/> <input type="checkbox"/> <input type="checkbox"/>	Wheel Type Encoder
Min. length measurement	MA	1 m
	MB	1 cm
	MC	1 mm
	YA	1 yard
	YB	0.1 yard
	YC	0.01 yard
Output signal	AB	A, B phase output (PSC-MA, YA), the others are A, B, Z Phase output
Output circuit	N	NPN voltage output
	O	NPN open collector
	T	Totem pole output
Power voltage	12	12 V d.c. (5 - 12 V d.c.)
	24	24 V d.c. (12 - 24 V d.c.)

※ The codes PSC-MA and PSC-YA are A, B phase output. The others are A, B, Z phase output

Thyristor Power Regulators

TPR-2N Single-Phase Thyristor Power Regulators 25A, 35A (except 380V models) 50 A (440 V models only)

Specifications

Model	TPR-2N□□□	TPR-2N□□□□
Appearance		
W×H×D (mm)	92.0×100.2×131.6	115.2×194.7×131.0
Function	Soft Start / Soft Down Slope setting	Soft start Overheated alarm (O.T) Alarm output Slope setting Output limit setting Overcurrent detection (O.C) Load break detection (L.L)
Power voltage	110 V a.c. / 220 V a.c. / 380 V a.c.	110 V a.c. / 220 V a.c. / 380 V a.c. / 440 V a.c.
Operating Frequency	50/60 Hz (dual usage)	
Rated Current	25 A, 35 A	50 A, 70 A
Protection Circuit	Protected by fast acting fuse (external attachment)	
Applied Load	Resistive Load/ Inductive Load	
Control Input	Input current: 4 - 20 mA d.c., Input Voltage: 1 - 5 V d.c. Input Contact Point: ON - OFF, External VR (10 kΩ)	Current input: 4 - 20 mA d.c., Voltage input: 1 - 5 V d.c. / 0 - 10 V d.c. (Option) Contact input: ON / OFF, External VR: External volume (10 kΩ)
Control Method	Phase control, Cycle control, ON/OFF control (selected by dip switch)	
Movement type	Soft start / Soft down (Time: 0 ~ 50 sec)	Soft start / Soft down
Output Adjusting Range	Above 95 % input voltage (when putting maximum of input voltage)	
Cooling Method	Natural Cooling	50 A (Natural cooling), 70 A (forced cooling)
Indicator Function	LED lighting for output status	
Insulation Resistance	Min. 100 MΩ (500 V d.c. mega standard)	
Output Range	0 ~ 100 %	
Dielectric Strength	2000 V a.c. 50/60 Hz for 1 min	
Line Noise	Noise by noise simulator (pulse width 1 μs : ±2 KV)	
Ambient temperature & humidity	0 ~ 50 °C, 30 ~ 85 % RH (without condensation)	
Storage temperature	-25 ~ 70 °C	
Weight	Approx. 960 g	Approx. 2000 g

Suffix code (25 A / 35 A)

※ Control Method : Phase control (factory default)

Model	Code	Content
TPR - 2N	□ □	Single-Phase Power Regulator
Power voltage	110	110 V a.c. 50/60 Hz (dual usage)
	220	220 V a.c. 50/60 Hz (dual usage)
	380	380 V a.c. 50/60 Hz (dual usage)
Rated current	25	25 A
	35	35 A

Suffix code (50A / 70A)

Model	Code	Content
TPR - 2N	□ □	Single-Phase Power Regulator
Power voltage	110	110 V a.c. 50/60 Hz (dual usage)
	220	220 V a.c. 50/60 Hz (dual usage)
	380	380 V a.c. 50/60 Hz (dual usage)
	440	440 V a.c. 50/60 Hz (dual usage)
Rated current	50	50 A
	70	70 A

Thyristor Power Regulators

TPR-2SL Slim Type Single-Phase Thyristor Power Regulators

Specifications

Model	Low voltage	TPR-2SL 025L	TPR-2SL 040L	TPR-2SL 055L	TPR-2SL 070L	TPR-2SL 090L	TPR-2SL 110L	TPR-2SL 130L	TPR-2SL 160L	TPR-2SL 200L
	High voltage	TPR-2SL 025H	TPR-2SL 040H	TPR-2SL 055H	TPR-2SL 070H	TPR-2SL 090H	TPR-2SL 110H	TPR-2SL 130H	TPR-2SL 160H	TPR-2SL 200H
Appearance										
W×H×D (mm)		47,0×148,0×151,7	60,0×183,0×172,1		60,0×203,0×172,1	85,0×219,0×205,1	85,0×245,5×205,1			
Power voltage	Low voltage	100 - 240 V a.c.								
	High voltage	380 - 440 V a.c.								
Circuit input power	100 - 240 V a.c.			100 - 240 V a.c.						
	6 W			16 W			20 W			
Power frequency	50/60 Hz									
Rated current (40 °C standard)	25A	40 A	55 A	70 A	90 A	110 A	130 A	160 A	200 A	
Fuse installation	None (optional)					Built-in fast acting fuse				
Applying load	Resistive load									
Control Input	Current input	4 - 20 mA d.c. (impedance: 100 Ω)								
	Voltage input	1 - 5 V d.c. (option: 0 - 10 V d.c.)								
	Contact input	ON/OFF								
	External VR	External volume (10 kΩ)								
Control method	Phase control, fixed cycle control, variable cycle control, ON/OFF control									
Movement type	Soft start / Soft up, down									
Output voltage	More than 98 % of the Power voltage (In case of maximum current input)									
Cooling method	Natural cooling			Forced cooling	Natural cooling	Forced cooling				
Display method	Display by LED									
Insulation resistance	Min. 100 MΩ (based on 500 V d.c. mega)									
Output control range	0 ~ 100 %									
Dielectric strength	3000 V a.c. 50/60 Hz for 1 min									
Line noise	Noise by noise simulator (3000 V)									
Ambient temperature & humidity	0 ~ 40 °C, 30 ~ 85 % RH (without condensation)									
Storage temperature	-25 ~ 70 °C									
Weight	1,388 g	1,388 g		1,478 g	2,820 g	3,100 g				

Suffix code

Model	Code	Content
TPR-2SL	<input type="checkbox"/> <input type="checkbox"/> <input type="checkbox"/> <input type="checkbox"/>	Slim Type Single-Phase Thyristor Power Regulator
Rated current	025	25 A
	040	40 A
	055	55 A
	070	70 A
	090	90 A
	110	110 A
	130	130 A
	160	160 A
Power voltage	L	100 - 240 V a.c. (low voltage)
	H	380 - 440 V a.c. (high voltage)
Option	C	RS485
	F	Built-in fuse type (for 25/40/55/70 A models)

※ The circuit need 100 - 240 V a.c. voltage power separately.

Thyristor Power Regulators

TPR-2M Slim Type Single-Phase Power Regulators

Specifications

Model	Economical type		Advanced type	
	Low voltage		Low voltage	High voltage
	TPR-2ME25L		TPR-2MS25L	TPR-2MS25H
	TPR-2ME35L		TPR-2MS35L	TPR-2MS35H
Appearance				
W×H×D (mm)	47.5×90.0×112.0			
Function	Soft start/Soft up/Soft down Over heat alarm	Soft start/Soft up/Soft down Output indication	Over heat alarm Power failure alarm	Over current alarm Slope setting SCR short alarm
Load Voltage	100 - 240 V a.c.		100 - 440 V a.c.	
Circuit input power	100 - 240 V a.c. 3 W		24 V d.c. 1 W	
Power frequency	50/60 Hz (dual usage)			
Rated current	25 A / 35 A			
Control Input	Current input	4 - 20 mA d.c. (impedance: 100 Ω) (Basic packages)	4 - 20 mA d.c. (impedance: 100 Ω) (Option)	
	Voltage input	1 - 5 V d.c. (Basic packages)	1 - 5 V d.c. (Option)	
	Contact input	ON/OFF (Basic packages)	ON/OFF (Option)	
	External VR	External VR (10 kΩ) Simultaneous use of current and voltage input is not supported	-	
Control method	Phase control (Basic), Variable Cycle control (Option)			
Movement type	Soft start (60 sec) / Soft up, Soft down (15 sec) / Adjust start time by SOFT VR			
Output voltage	More than 98 % of the Power voltage (In case of maximum current input) / Output limitation control by Power VR			
Alarm function	-	O (Relay contact output): current error (CE), over temperature (OT), power error / heater break (PE), SCR short (PE)		
Display method (LED)	Output	FIRE: Flicker speed directly proportional to output		
	Power	Light on when power connect to circuit	-	
	Alarm	-	CE (CURRENT ERROR): Light on in case of more than 45 A load	
		-	OT (OVER TEMP): Light on when Heat sink temperature is above 85 °C	
		PE (power ERROR): Power error, Heater break		
Cooling method	Natural cooling			
Weight	Approx. 322 g			

Suffix code

Model	Code	Content
TPR-2M	<input type="checkbox"/> <input type="checkbox"/> <input type="checkbox"/> <input type="checkbox"/> <input type="checkbox"/>	Slim Type Single-Phase Power Regulator
Type	E	Economical type 25 A 100 - 24 V a.c. only
	S	Advanced type
Rated current	25	25 A
	35	35 A
Power voltage	L	100 - 240 V a.c.
	H	100 - 440 V a.c. (only for advanced type)
Control input (for Advanced type only)	C	4 - 20 mA d.c.
	V	1 - 5 V d.c.
	O	ON/OFF
		Economical Type (E) supports all input options.

※ Please supply power separately for circuit input (100 - 240 V a.c. for low voltage, 24 V d.c. for high voltage)

Thyristor Power Regulators

TPR-3 3-Phase Power Regulators

Specifications

Model	TPR-3P□ 70MR	TPR-3P□ 100MR	TPR-3P□ 150MR	TPR-3P□ 200MR	TPR-3P□ 250MR	TPR-3P□ 320MR	TPR-3P□ 500MR	TPR-3P□ 600MR
Appearance								
W×H×D (mm)	235.0×360.0×180.0		256.0×440.0×200.0			266.0×524.0×225.0	337.0×548.0×237.0	338.0×613.0×253.0
Function	Power failure and fuse break (L,E) alarm output Overcurrent detection alarm output Current limit setting Soft start down Manual setting (slope setting)							
Power voltage	220 V a.c. / 380 V a.c. / 440 V a.c.							
Applying frequency	50/60 Hz (dual usage)							
Rated current	70 A	100 A	150 A	200 A	250 A	320 A	500 A	600 A
Protective circuit	Fuse break alarm, Over current alarm, Overheating heat sink							
Applying load	Resistive load / Inductive load							
Control input	Current Input	4 - 20 mA d.c.						
	Voltage Input	0 - 5 V d.c. / 1 - 5 V d.c. / 0 - 10 V d.c.						
	Contact Input	ON/OFF						
	External VR	External volume (10 KΩ)						
Control type	Phase control, ON/OFF control, Cycle control							
Start type	Soft start / Soft down							
Output voltage	More than 95 % of the Power voltage (In case of maximum current input)							
Cooling type	Forced cooling (150 A ~ 600 A), Forced cooling (70 A, 100 A), Need separate power supply for FAN (320 A, 500 A and 600 A)							
Display method	Display by LED light							
Insulation resistance	Min. 100 MΩ (Base on 500 V d.c. mega)							
Output adjustable range	0 ~ 100 %							
Dielectric strength	2000 V a.c. 50/60 Hz for 1 min							
Line noise	Noise by noise simulator (2 kW)							
Ambient temperature & humidity	0 ~ 40 °C, 35 ~ 85 % RH (without condensation)							
Storage temperature	-25 ~ 70 °C							
Weight	11 kg		15 kg			22 kg	35 kg	40 kg

Suffix code

Model	Code	Content
TPR-3P	□ □	3-Phase Power Regulator
Power voltage	220	220 V a.c.
	380/440	380 V a.c. / 440 V a.c.
Rated current	70	70 A
	100	100 A
	150	150 A
	200	200 A
	250	250 A
	320	320 A
	500	500 A
600	600 A	

Thyristor Power Regulators

TPR-3N 3-Phase Power Regulators

Specifications

Model	TPR-3N□□□	
Appearance		
W×H×D (mm)	169,0×361,0×213,3	
Function	LED display function input signal selection Operation mode selection (resistive load, inductive load)	
	Overcurrent alarm output (OC) Power failure and fuse break alarm output Load break alarm (LL) Alarm output	
	LED ON when heat sink is overheated (OT) (thermal start fixed to 85 °C)	
Number of phase	Three phase	
Rated current	70 A, 100 A	
Control method	Phase control, ON/OFF control	
Applying load	Resistive load, inductive load	
Power voltage	(220, 380, 440 V) a.c. 50/60 Hz (dual usage)	
Output voltage range	More than 95 % of the input voltage (min. load more than 0.5A)	
Input signal	4 - 20 mA d.c., 0 - 5, 1 - 5, 0 - 10 V d.c. contact input, manual setting	
Output setting range	Slope setting: 50 % (when inductive load is selected) Output Limit: 0 ~ 100 % Manual setting: 0 ~ 100 % (selected by the external B 10 KΩ volume or parameter)	
Movement method	Soft Up / Soft Down (setting: 0 ~ 50 sec)	
Alarm output	Overcurrent alarm (OC) Power failure and fuse break alarm Load break (LL) alarm Overheated heat sink	
	Relay contact output (1a contact) max. 250 V a.c., 10 A (resistive load)	
Insulation resistance	Min. 100 MΩ, 500 V d.c.	
Dielectric strength	2000 V for 1 min	
Cooling method	Forced cooling by fan	
Ambient temperature & humidity	0 ~ 50 °C, 35 ~ 85 % RH (without condensation)	
Storage temperature	-25 ~ 70 °C	
Weight	Approx. 5 kg (Included the weight of box)	

Suffix code

Model	Code	Content
TPR-3N	□ □	3-Phase Power Regulator
Power voltage	220	220 V a.c.
	380	380 V a.c.
	440	440 V a.c.
Rated current	70	70 A
	100	100 A

Thyristor Power Regulators

TPR-3SL Slim Type 3-Phase Thyristor Power Regulators

Specifications

Model	low voltage	TPR-3SL040L	TPR-3SL055L	TPR-3SL070L	TPR-3SL090L	TPR-3SL130L	TPR-3SL160L	
	high voltage	TPR-3SL040H	TPR-3SL055H	TPR-3SL070H	TPR-3SL090H	TPR-3SL130H	TPR-3SL160H	
Appearance								
Function	Soft start / Soft up, down, Over heat alarm, Over current alarm, Slope setting, Load break alarm, Output indication, Power failure alarm, SCR short alarm							
Power voltage	Low	100 - 240 V a.c.						
	High	380 - 440 V a.c.						
Circuit input power	100 - 240 V a.c. 18 W			100 - 240 V a.c. 20 W				
Power frequency	50/60 Hz (dual usage)							
Rated current	40 A, 55 A, 70 A, 90 A, 130 A, 160 A							
Applying load	Resistive load							
Control Input	Current input	4 - 20 mA d.c. (impedance: 100 Ω)						
	Voltage input	1 - 5 V d.c.						
	Contact input	ON / OFF						
	External VR	External volume (10 KΩ)						
Control method	Phase control, Fixed Cycle control, Variable Cycle control, ON/OFF control							
Movement type	Soft start / Soft up, down							
Output voltage	More than 98 % of the Power voltage (In case of maximum current input)							
Cooling method	Natural cooling (40 A, 55 A), Forced cooling (70 A, 90 A, 130 A, 160 A)							
Display method	Display by LED							
Insulation resistance	Min. 100 MΩ (Base on 500 V d.c. mega)							
Output control range	0 ~ 100 %							
Dielectric strength	3000 V a.c. 50/60 Hz for 1 min							
Line noise	Noise by noise simulator (2500 V)							
Ambient temperature & humidity	0 ~ 40 °C, 30 ~ 85 % RH (without condensation)							
Storage temperature	-25 ~ 70 °C							
Weight	4,044 g		4,324 g		9,100 g		9,194 g	

Suffix code

Model	Code	Content
TPR-3SL	<input type="checkbox"/> <input type="checkbox"/> - <input type="checkbox"/>	Slim Type 3-Phase Power Regulator
Rated current	040	40 A
	055	55 A
	070	70 A
	090	90 A
	130	130 A
	160	160 A
Power voltage	L	100 - 240 V a.c. (Low)
	H	380 - 440 V a.c. (High)
Option	-	Fuse built-in
	N	No fuse

※ Circuit and fan need 100 - 240 V a.c. voltage power separately.

Thyristor Power Regulators

TPR-3SL-EP 3-Channel Each Phase Control Thyristor Power Regulators

Specifications

Model	low voltage	TPR-3SL040L-EP	TPR-3SL055L-EP	TPR-3SL070L-EP	TPR-3SL090L-EP	TPR-3SL130L-EP	TPR-3SL160L-EP	
	high voltage	TPR-3SL040H-EP	TPR-3SL055H-EP	TPR-3SL070H-EP	TPR-3SL090H-EP	TPR-3SL130H-EP	TPR-3SL160H-EP	
Appearance								
	Power voltage	Low voltage	100 - 240 V a.c.					
		High voltage	100 - 440 V a.c.					
Circuit input power		100 - 240 V a.c. 18 W						
Power frequency		50/60 Hz						
Rated current		40 A	55 A	70 A	90 A	130 A	160 A	
Applying load		Resistive load						
Current input		4 - 20 mA d.c. (impedance: 100 Ω)						
Control type		Phase control, fixed cycle control, variable cycle control, ON/OFF control						
Movement type		Soft start / Soft up, down						
Output voltage		More than 98 % of the Power voltage (In case of maximum current input)						
Cooling method		Forced cooling						
Display method		Display by LED						
Insulation resistance		Min. 100 MΩ (500 V d.c. Mega standard)						
Output control range		0 ~ 100 %.						
Dielectric strength		3000 V a.c. 50/60 Hz for 1 min						
Line noise		Noise by noise simulator (2500 V)						
Ambient temperature & humidity		0 ~ 40 °C, 30 ~ 85 % RH (without condensation)						
Storage temperature		-25 ~ 70 °C						
Weight		4,324 g			9,194 g	9,288 g		

Suffix code

Model	Code	Content
TPR-3SL	□ □ - □	3-Channel Each Phase Control Thyristor Power Regulator
Rated current	040	40 A
	055	55 A
	070	70 A
	090	90 A
	130	130 A
	160	160 A
Power voltage	L	100 - 240 V a.c. (low voltage)
	H	100 - 440 V a.c. (high voltage)
Option	EP	Each phase control (individual control of 3 devices)

- ※ Circuit and fan need 100 - 240 V a.c. voltage power separately.
- ※ For 130 A, 160 A products, the fan need 24 V d.c. voltage power.

Thyristor Power Regulators

TPR-3M Mini 3-Phase Power Regulators

Specifications

Model	TPR-3M25L	TPR-3M45L
Appearance		
W×H×D (mm)	110.0×157.5×150.0	
Function	Over heat alarm, Over current alarm, Load break alarm, Output indication, SCR short alarm	
Power voltage	100 - 240 V a.c.	
Circuit input power	24 V d.c. 8 W	
Power frequency	50/60 Hz	
Rated current	25 A	45 A
Applying load	Resistive load	
Control Input	4 - 20 mA d.c. (impedance: 100 Ω)	
Control method	Phase control (Fixed Cycle control, Variable Cycle control Option)	
Output voltage	More than 98 % of the Power voltage (In case of maximum current input)	
Cooling method	Forced cooling (24 V d.c. FAN)	
Display method	4 LED display status and alarm status	
Insulation resistance	Min. 100 MΩ (Base on 500 V d.c. mega)	
Dielectric strength	2500 V a.c. 50/60 Hz for 1 min	
Line noise	Noise by noise simulator (2000 V)	
Storage temperature	-30 ~ 90 °C	
Ambient temperature & humidity	-20 ~ 80 °C, 45 ~ 85 % RH (without condensation)	
Weight	1,756 g	

Suffix code

Model	Code	Content
TPR-3M	<input type="checkbox"/> <input type="checkbox"/> <input type="checkbox"/>	Mini 3-Phase Power Regulator
Rated current	25	25 A
	45	45 A
Power voltage	L	100 - 240 V a.c. (Low)
Option	IS	Power isolation for multi series connection

※ IS type support connection in series up to 5 units with 1 temperature controller or power supply (SMPS.)
The general type requires a 1 to 1 connection to the temperature controller with a 24 V d.c. partial power circuit as a non-isolated type.

Solid State Relays

SSR-2 series Single-Phase Solid State Relays

Specifications

DC input - AC load

Model	Low	SSR-2D102Z	SSR-2D202Z	SSR-2D302Z	SSR-2D402Z	
	High	SSR-2D104Z	SSR-2D204Z	SSR-2D304Z	SSR-2D404Z	
Appearance						
W×H×D (mm)	42.0×64.0×27.3					
L O A D	Load voltage range	Low	90 - 264 V a.c.			
		High	90 - 480 V a.c.			
	Peak Voltage (Non-repetition)	Low	600 V			
		High	800 V	1,200 V		
	Rated load current	10 A	20 A	30 A	40 A	
	Frequency	50/60 Hz				
	Surge current (8.3 ms No repetition)	Low	170 A	260 A	420 A	
		High	170 A	250 A	370 A	
	Leakage current	Max. 20 mA				
	Output ON voltage dropping	Less than 1.6 V (R.M.S)				
I N P U T	Rated Voltage	5 - 24 V d.c.				
	Operating voltage range	4.6 - 32 V d.c.				
	Impedance	Less than 4 kΩ				
	Operation voltage	More than 4.6 V d.c.				
	Input current	Constant-current system: 8 mA (±3)				
Response Time	1/2 Cycle + max. 1 ms ("R" type below 1 ms)					
Insulating Resistance	500 V d.c., 100 MΩ (between the input / output and case)					
Dielectric strength	2500 V a.c. 60 Hz for 1 min					
Vibration resistance	10 - 55 Hz, double amplitude: 1.5 mm, X,Y, and Z direction for 2 hours					
Shock resistance	1000 m/s ² , X,Y,Z each axis 3 times					
Storage temperature	-30 ~ 90 °C					
Ambient temperature & humidity	-5 ~ 40 °C, 45 ~ 85 % RH (without icing)					
Ambient Humidity	45 ~ 85 % RH					
Pollution degree	Pollution degree 2					
Usage	Resistive load / Inductive load					
Accepted standard	IEC 62314					
Weight	Approx. 89 g					

Temperature Controllers
Recorders
Digital Counter/ Timers
Analog Timers
Multi Pulse Meters
Panel Meters
Peripheral Devices
Proximity Sensors
Photo Sensors
Rotary Encoders
Thyristor Power Regulators
Solid State Relays
Power Supplies
Control Switches / Combination
Display Lights
Power / Main / Cam Switches
Limit Switches
Micro Switches
Foot / Mono Lever / Pendant Switches
Signal Lights
Power Buzzers / Terminal Blocks Fuse Holders / Control Boxes

Solid State Relays

■ AC input - AC load

Model	Low	SSR-2A102Z	SSR-2A202Z	SSR-2A302Z	SSR-2A402Z	
	High	SSR-2A104Z	SSR-2A204Z	SSR-2A304Z	SSR-2A404Z	
Appearance						
W×H×D (mm)	42.0×64.0×27.3					
L O A D	Load voltage range	Low	90 - 264 V a.c.			
		High	90 - 480 V a.c.			
	Peak Voltage (Non-repetition)	Low	600 V			
		High	800 V	1,200 V		
	Rated load current	10 A	20 A	30 A	40 A	
	Frequency	50/60 Hz				
	Surge current (8.3 ms No repetition)	Low	170 A	260 A	420 A	
		High	170 A	250 A	370 A	
	Leakage current	Max. 20 mA				
	Output ON voltage dropping	Less than 1.6 V (RMS)				
I N P U T	Rated Voltage	100 - 240 V a.c.				
	Operating voltage range	70 - 264 V a.c.				
	Impedance	Less than 40 kΩ				
	Operation voltage	More than 70 V a.c.				
	Input current	220 V a.c. : 8 mA				
Response Time	1/2 Cycle + max. 1 ms ("R" type below 1 ms)					
Insulating Resistance	500 V d.c., 100 MΩ (between the input / output and case)					
Dielectric strength	2500 V a.c. 60 Hz for 1 min					
Vibration resistance	10 - 55 Hz, double amplitude: 1.5 mm, X,Y, and Z direction for 2 hours					
Shock resistance	1000 m/s, X,Y,Z each axis 3 times					
Storage temperature	-30 ~ 90 °C					
Ambient temperature & humidity	-5 ~ 40 °C, 45 ~ 85 % RH (without icing)					
Pollution degree	Pollution degree 2					
Usage	Resistive load / Inductive load					
Accepted standard	IEC 62314					
Weight	Approx. 89 g					

■ Suffix code

Model	Code	Content
SSR-2	<input type="checkbox"/> <input type="checkbox"/> <input type="checkbox"/> <input type="checkbox"/> <input type="checkbox"/>	Single-Phase Solid State Relay
Input Control Voltage	D	5 - 24 V d.c.
	A	100 - 240 V a.c.
Rated load current	10	10 A
	20	20 A
	30	30 A
	40	40 A
Rated load voltage	2	90 - 264 V a.c. (Low)
	4	90 - 480 V a.c. (High)
Operation method	Z	Zero Cross Switching (standard product)
	R	Random Switching

Solid State Relays

■ HSR-2 series Single-Phase Solid State Relays

■ Specifications

■ DC input - AC load (Low voltage: 90 - 264 V a.c.)

Model		HSR-2D102□	HSR-2D202□	HSR-2D302□	HSR-2D402□	HSR-2D502□	HSR-2D702□
Appearance							
W×H×D (mm)		44.0×64.0×28.6					
Input	Rated voltage	5 - 24 V d.c.					
	Voltage use range	4 - 32 V d.c.					
	Impedance	Less than 4 kΩ					
	Operating voltage	More than 3 V d.c.					
	Release voltage	Less than 1.5 V					
Load	Rated load voltage	100 - 240 V a.c.					
	Load voltage range	90 - 264 V a.c.					
	Rated load current	10 A	20 A	30 A	40 A	50 A	70 A
	Input current	170 A	250 A	315 A		580 A	
	Output voltage drop	1.3 V	1.6 V			1.8 V	
	Leakage current	10 mA	15 mA				

■ AC input - AC load (Low voltage: 90 - 264 V a.c.)

Model		HSR-2A102□	HSR-2A202□	HSR-2A302□	HSR-2A402□	HSR-2A502□	HSR-2A702□
Appearance							
W×H×D (mm)		44.0×64.0×28.6					
Input	Rated voltage	100 - 240 V d.c.					
	Voltage use range	90 - 264 V d.c.					
	Impedance	Less than 40 kΩ					
	Operating voltage	More than 72 V a.c.					
	Release voltage	Less than 40 V a.c.					
Load	Rated load voltage	100 - 240 V a.c.					
	Load voltage range	90 - 264 V a.c.					
	Rated load current	10 A	20 A	30 A	40 A	50 A	70 A
	Input current	170 A	250 A	315 A		580 A	
	Output voltage drop	1.3 V	1.6 V			1.8 V	
	Leakage current	15 mA					

■ DC input - AC load (High voltage: 90 - 480 V a.c.)

Model		HSR-2D104□	HSR-2D204□	HSR-2D304□	HSR-2D404□	HSR-2D504□	HSR-2D704□
Appearance							
W×H×D (mm)		44.0×64.0×28.6					
Input	Rated voltage	5 - 24 V d.c.					
	Voltage use range	4 - 32 V d.c.					
	Impedance	Less than 4 kΩ					
	Operating voltage	More than 3 V d.c.					
	Release voltage	Less than 1.4 V d.c.					
Load	Rated load voltage	100 - 440 V a.c.					
	Load voltage range	90 - 480 V a.c.					
	Rated load current	10 A	20 A	30 A	40 A	50 A	70 A
	Input current	170 A	250 A	350 A	370 A	580 A	
	Output voltage drop	1.3 V	1.6 V			1.8 V	
	Leakage current	20 mA					

Solid State Relays

■ AC input - AC load (High voltage: 90 - 480 V a.c.)

Model	HSR-2A104□	HSR-2A204□	HSR-2A304□	HSR-2A404□	HSR-2A504□	HSR-2A704□	
Appearance							
W×H×D (mm)	44.0×64.0×28.6						
Input	Rated voltage	100 - 240 V a.c.					
	Voltage use range	90 - 264 V a.c.					
	Impedance	Less than 40 kΩ					
	Operating voltage	More than 75 V a.c.					
	Release voltage	Less than 40 V a.c.					
Load	Rated load voltage	100 - 440 V a.c.					
	Load voltage range	90 - 480 V a.c.					
	Rated load current	10 A	20 A	30 A	40 A	50 A	70 A
	Input current	170 A	250 A	350 A	370 A	580 A	
	Output voltage drop	1.3 V	1.6 V	1.8 V			
Leakage current	15 mA				20 mA		

■ General specifications

Insulation resistance	500 V d.c. 100 MΩ (between I/O and case)
Dielectric strength	2500 V a.c. (1 minute at 60Hz)
Vibration resistance	10 - 55 Hz double amplitude width 1.5 mm/ X.Y.Z each direction for 2 hours
Shock resistance	1000 m/s ² (approx. 100G) X.Y.Z each axis 3 times
Storage temperature	-30 ~ 90 °C
Ambient temperature & humidity	-20 ~ 80 °C, 45 ~ 85 % RH
Net weight	Approx. 150 g (including packing box)

■ Suffix code

Model	Code	Content
HSR-2	□ □ □ □ □	Single phase solid state relay
Input voltage	D	4 - 32 V d.c.
	A	90 - 264 V a.c.
Rated load current	10	10 A
	20	20 A
	30	30 A
	40	40 A
	50	50 A
	70	70 A
Load voltage	2	90 - 264 V a.c. (low voltage)
	4	90 - 480 V a.c. (high voltage)
Operation method	Z	Zero Cross Switching
	R	Random Switching
Radiator attachment state	-	No indication (no radiator)
	T	Radiator in one body type (only with 50 A and 70 A)

Solid State Relays

■ SSR-3 series 3-phase solid state relay

■ DC input - AC load

Model		Low	SSR-3D102Z	SSR-3D202Z	SSR-3D302Z	SSR-3D402Z	
		High	SSR-3D104Z	SSR-3D204Z	SSR-3D304Z	SSR-3D404Z	
Appearance							Temperature Controllers
							Recorders
W×H×D (mm)		109.0×60.0×31.3					Digital Counter/ Timers
L O A D	Load voltage range	Low	90 - 264 V a.c.				Analog Timers
		High	90 - 480 V a.c.				
	Peak Voltage (Non-repetition)	Low	600 V				Multi Pulse Meters
		High	800 V	1,200 V			
	Rated load current		10 A	20 A	30 A	40 A	Panel Meters
	Frequency		50/60 Hz				Peripheral Devices
	Surge current (8.3 ms No repetition)	Low	170 A	260 A	420 A		
		High	170 A	250 A	370 A		
	Leakage current		Max. 20 mA				Proximity Sensors
	Output ON voltage dropping		Less than 1.6 V (RMS)				Photo Sensors
I N P U T	Rated Voltage		5 - 24 V d.c.				Rotary Encoders
	Operating voltage range		4.6 - 32 V d.c.				
	Impedance		Less than 4 kΩ				Thyristor Power Regulators
	Operation voltage		More than 4.6 V d.c.				
	Input current		Constant-current system: 12 mA (±3)				
Response Time		1/2 Cycle + max. 1 ms ("R" type below 1 ms)				Solid State Relays	
Insulating Resistance		500 V d.c., 100 MΩ (between the input / output and case)				Power Supplies	
Dielectric strength		2500 V a.c. 60 Hz for 1 min					
Vibration resistance		10 - 55 Hz, double amplitude: 1.5 mm, X,Y, and Z direction for 2 hours				Control Switches / Combination Display Lights	
Shock resistance		1000 m/s ² , X,Y,Z each axis 3 times					
Storage temperature		-30 ~ 90 °C				Power / Main / Cam Switches	
Ambient temperature & humidity		-5 ~ 40 °C, 45 ~ 85 % RH (without icing)					
Pollution degree		Pollution degree 2				Limit Switches	
Usage		Resistive load / Inductive load					
Accepted standard		IEC 62314				Micro Switches	
Weight		Approx. 227 g					

Temperature Controllers
Recorders
Digital Counter/ Timers
Analog Timers
Multi Pulse Meters
Panel Meters
Peripheral Devices
Proximity Sensors
Photo Sensors
Rotary Encoders
Thyristor Power Regulators
Solid State Relays
Power Supplies
Control Switches / Combination Display Lights
Power / Main / Cam Switches
Limit Switches
Micro Switches
Foot / Mono Lever / Pendant Switches
Signal Lights
Power Buzzers / Terminal Blocks Fuse Holders / Control Boxes

Solid State Relays

■ AC input - AC load

Model		Low	SSR-3A102Z	SSR-3A202Z	SSR-3A302Z	SSR-3A402Z
		High	SSR-3A104Z	SSR-3A204Z	SSR-3A304Z	SSR-3A404Z
Appearance						
W×H×D (mm)		109,0×60,0×31,3				
LOAD	Load voltage range	Low	90 - 264 V a.c.			
		High	90 - 480 V a.c.			
	Peak Voltage (Non-repetition)	Low	600 V			
		High	800 V	1,200 V		
	Rated load current		10 A	20 A	30 A	40 A
	Frequency		50/60 Hz			
	Surge current (8.3 ms No repetition)	Low	170 A	260 A	420 A	
		High	170 A	250 A	370 A	
	Leakage current		Max. 20 mA			
	Output ON voltage dropping		Less than 1.6 V (RMS)			
INPUT	Rated Voltage		100 - 240 V a.c.			
	Operating voltage range		70 - 264 V a.c.			
	Impedance		Less than 40 kΩ			
	Operation voltage		More than 70 V a.c.			
	Input current		220 V a.c. : 8 mA			
Response Time		1/2 Cycle + max. 1 ms ("R" type below 1 ms)				
Insulating Resistance		500 V d.c., 100 MΩ (between the input / output and case)				
Dielectric strength		3000 V a.c. 60 Hz for 1 min				
Vibration resistance		10 - 55 Hz, double amplitude: 1.5 mm, X,Y, and Z direction for 2 hours				
Shock resistance		1000 m/s ² , X,Y,Z each axis 3 times				
Storage temperature		-30 ~ 90 °C				
Ambient temperature & humidity		-5 ~ 40 °C, 45 ~ 85 % RH (without icing)				
Pollution degree		Pollution degree 2				
Usage		Resistive load / Inductive load				
Accepted standard		IEC 62314				
Weight		Approx. 227 g				

■ Suffix code

Model	Code	Content
SSR-3	<input type="checkbox"/> <input type="checkbox"/> <input type="checkbox"/> <input type="checkbox"/> <input type="checkbox"/>	3-Phase Solid State Relay
Input Control Voltage	D	5 - 24 V d.c.
	A	100 - 240 V a.c.
Rated load current	10	10 A
	20	20 A
	30	30 A
	40	40 A
Rated load voltage	2	90 - 264 V a.c. (Low)
	4	90 - 480 V a.c. (High)
Operation method	Z	Zero Cross Switching (standard product)
	R	Random Switching

Solid State Relays

■ HSR-3 series 3-Phase Solid State Relays

■ DC input - AC load (Low voltage: 90 - 264 V a.c.)

Model		HSR-3D102	HSR-3D202	HSR-3D302	HSR-3D402	HSR-3D502	HSR-3D702
Appearance							
W×H×D (mm)		109.0×74.8×34.5					
Input	Rated voltage	5 - 24 V d.c.					
	Voltage use range	4 - 32 V d.c.					
	Impedance	Less than 4 kΩ					
	Operating voltage	More than 3 V d.c.					
	Release voltage	Less than 1.4 V d.c.					
Load	Rated load voltage	100 - 240 V a.c.					
	Load voltage range	90 - 264 V a.c.					
	Rated load current	10 A	20 A	30 A	40 A	50 A	70 A
	Input current	125 A	260 A	315 A		580 A	
	Output voltage drop	1.5 V	1.8 V				
Leakage current	1.5 mA	Below 1.8 mA				15 mA	
Net weight		Approx. 400 g (including packing box)					

■ AC input - AC load (Low voltage: 90 - 264 V a.c.)

Model		HSR-3A102	HSR-3A202	HSR-3A302	HSR-3A402	HSR-3A502	HSR-3A702
Appearance							
W×H×D (mm)		109.0×74.8×34.5					
Input	Rated voltage	100 - 240 V a.c.					
	Voltage use range	90 - 264 V a.c.					
	Impedance	Less than 40 kΩ					
	Operating voltage	More than 72 V a.c.					
	Release voltage	Less than 50 V a.c.					
Load	Rated load voltage	100 - 240 V a.c.					
	Load voltage range	90 - 264 V a.c.					
	Rated load current	10 A	20 A	30 A	40 A	50 A	70 A
	Input current	125 A	260 A	315 A		580 A	
	Output voltage drop	1.3 V	1.6 V	1.8 V			
Leakage current	20 mA				15 mA		
Net weight		Approx. 400 g (including packing box)					

■ DC input - AC load (High voltage: 90 - 480 V a.c.)

Model		HSR-3D104	HSR-3D204	HSR-3D304	HSR-3D404	HSR-3D504	HSR-3D704
Appearance							
W×H×D (mm)		109.0×74.8×34.5					
Input	Rated voltage	5 - 24 V d.c.					
	Voltage use range	4 - 32 V d.c.					
	Impedance	Less than 4 kΩ					
	Operating voltage	More than 3 V d.c.					
	Release voltage	Less than 1.4 V d.c.					
Load	Rated load voltage	100 - 440 V a.c.					
	Load voltage range	90 - 480 V a.c.					
	Rated load current	10 A	20 A	30 A	40 A	50 A	70 A
	Input current	170 A	250 A	315 A		580 A	
	Output voltage drop	1.95 V	1.8 V	1.8 V			
Leakage current	Below 20 mA						
Net weight		Approx. 400 g (including packing box)			Approx. 2000 g		Approx. 2600 g

Solid State Relays

■ AC input - AC load (High voltage: 90 - 480 V a.c.)

Model	HSR-3A104□	HSR-3A204□	HSR-3A304□	HSR-3A404□	HSR-3A504□	HSR-3A704□	
Appearance							
W×H×D (mm)	109.0×74.8×34.5						
Input	Rated voltage	100 - 240 V d.c.					
	Voltage use range	90 - 264 V d.c.					
	Impedance	Less than 72 kΩ					
	Operating voltage	More than 75 V a.c.					
	Release voltage	Less than 40 V a.c.					
Load	Rated load voltage	100 - 440 V a.c.					
	Load voltage range	90 - 480 V a.c.					
	Rated load current	10 A	20 A	30 A	40 A	50 A	70 A
	Input current	170 A	250 A	350 A	370 A	580 A	
	Output voltage drop	1.95 V	1.8 V				
Leakage current	Below 20 mA						
Net weight	Approx. 400 g (including packing box)				Approx. 2000 g (including packing box)	Approx. 2600 g (including packing box)	

■ General specifications

Insulation resistance	500 V d.c. 100 MΩ (between I/O and case)
Dielectric strength	2500 V a.c. (1 minute at 60 Hz)
Vibration resistance	10 - 55 Hz double amplitude width 1.5 mm/ X.Y.Z each direction for 2 hours
Shock resistance	1000 m/s ² X.Y.Z each axis 3 times
Storage temperature	-30 ~ 90 °C
Ambient temperature & humidity	-20 ~ 80 °C, 45 ~ 85 % RH

■ Suffix code

Model	Code	Content
HSR-2	□ □ □ □ □	3-Phase Solid State Relay
Input voltage	D	4 - 32 V d.c.
	A	90 - 264 V a.c.
Rated load current	10	10 A
	20	20 A
	30	30 A
	40	40 A
	50	50 A
	70	70 A
Load voltage	2	90 - 264 V a.c. (low voltage)
	4	90 - 480 V a.c. (high voltage)
Operation method	Z	Zero cross switching (standard product)
	R	Random switching
Radiator attachment state	-	No indication (no radiator)
	T	Radiator in one body type (only with 50A and 70A)

(Note) Operation method Z: zero cross switching, R: random switching

HSR-SL series Single-Phase Solid State Relays

Specifications

Model	Low voltage	HSR-SLD152Z	HSR-SLD252Z	HSR-SLD402Z	
	High voltage	HSR-SLD154Z	HSR-SLD254Z	HSR-SLD404Z	
Appearance					
WXHxD (mm)	CE	22.4×99.0×98.5		44.4×99.0×98.5	
	S-MARK	22.4×99.0×98.5	44.4×99.0×98.5	85.0×114.0×118.0	
LOAD	Load voltage range	Low voltage	90 - 264 V a.c.		
		High voltage	90 - 480 V a.c.		
	Peak Voltage (non-repetition)	Low voltage	600 V		
		High voltage	800 V	1,200 V	
	Rated load current	15 A	25 A	40 A	
	Frequency	50/60 Hz			
	Surge current (8.3 ms non-repetition)	Low voltage	170 A	260 A	420 A
		High voltage	170 A	250 A	370 A
	Leakage current	Max. 20 mA			
	Output ON voltage drop	Max. 1.6 V (RMS)			
INPUT	Rated voltage	5 - 24 V d.c.			
	Operating voltage range	4 - 32 V d.c.			
	impedance	Max. 4 kΩ			
	Operating voltage	Min. 3 V d.c.			
	Return voltage	Max. 1.5 V d.c.			
	Current input	Constant-current system: 8 mA (±3)			
Response time	1/2 Cycle + max. 1 ms. ("R" type max. 1 ms)				
Insulation resistance	500 V d.c., 100 MΩ (between the input / output and case)				
Dielectric strength	3000 V a.c. 60 Hz for 1 min				
Vibration resistance	10 - 55 Hz, double amplitude: 1.5 mm, X·Y·Z each direction 2 hours				
Shock resistance	1000 m/s², X·Y·Z each axis 3 times				
Storage temperature	-30 ~ 90 °C				
Ambient temperature & humidity	-5 ~ 40 °C, 45 ~ 85 % RH (without condensation)				
Pollution degree	Pollution degree 2				
Usage	Resistive load / inductive load				
Applicable standard	IEC 62314				
Weight	Approx. 230 g		Approx. 372 g		

Suffix code



Model	Code	Content
HSR-SL	<input type="checkbox"/> <input type="checkbox"/> <input type="checkbox"/> <input type="checkbox"/> <input type="checkbox"/> <input type="checkbox"/> <input type="checkbox"/>	Slim Type Single-Phase Solid State Relay
Input voltage	D	4 - 32 V d.c.
Contact	-	1 contact (no mark)
	2C	2 contacts (only for 15 A)
Rated load current	15	15 A
	25	25 A
	40	40 A
Rated load voltage	2	90 - 264 V a.c. (low voltage)
	4	90 - 480 V a.c. (high voltage)
Operation type	Z	Zero cross switching (standard product)
	R	Random switching
Option	BI	Bimetal 60 °C / 80 °C mark

※ 2 contact type only available for 15 A low/high voltage models (HSR-SLD2C152Z, HSR-SLD2C154Z)

Solid State Relays

■ HSR-2SLD/SE series Slim Type Single-Phase Solid State Relays (HSR-2SLD)

Specifications

Model		Low	HSR-2SE252Z	HSR-2SLD252Z	HSR-2SLD402Z
		High	HSR-2SE254Z	HSR-2SLD254Z	HSR-2SLD404Z
Appearance					
W×H×D (mm)		58.0×96.6×130.0		79.0×96.6×131.3	95.0×96.6×156.7
Load	Load voltage range	Low	90 - 264 V a.c.		
		High	90 - 480 V a.c.		
	Peak Voltage (Non-repetition)	Low	600 V		
		High	1,200 V		
	Rated load current		25 A		40 A
	Frequency		50/60 Hz		
	Surge current (8.3 ms No repetition)	Low	260 A		420 A
		High	250 A		370 A
Leakage current		Less than 10 mA			
Output ON voltage dropping		Less than 1.8 V (RMS)			
Rated impulse withstand voltage	Low	4 kV			
	High	6 kV			
Input	Rated Voltage		5 - 24 V d.c.		
	Operating voltage range		4 - 32 V d.c.		
	Impedance		Less than 4 kΩ		
	Operation voltage		More than 3 V d.c.		
	Reset voltage		Less than 1.5 V d.c.		
	Input current		Constant-current system: 10 mA (±3)		
Detection parts	Rated Voltage		24 V d.c.		
	Operating voltage range		20 - 26 V d.c.		
	Power consumption		Max. 25 mA, max. 40 mA in case of Alarm output (Base on 24 V d.c.)		
	Collector pressure		Less than 30 V d.c.		
	Maximum rated through current		Less than 50 mA		
	Max. collector power consumption		500 mW		
Output type		Transistor open collector (Hi at detection of problem)			
Response Time		1/2 Cycle + max. 1 ms ("R" type below 1 ms)			
Insulating Resistance		500 V d.c., 100 MΩ (between the input / output and case)			
Dielectric strength		2500 V a.c. 60 Hz for 1 min			
Vibration resistance		10 - 55 Hz, double amplitude: 1.5 mm, X,Y, and Z direction for 2 hours			
Shock resistance		1000 m/s, X,Y,Z each axis 3 times			
Storage temperature		-30 ~ 90 °C			
Ambient temperature & humidity		-20 ~ 80 °C, 45 ~ 85 % RH (without icing)			
Pollution degree		Pollution degree 2			
Degree of protection		IP20 (IEC 60529)			
Usage		Resistive load / Inductive load			
Accepted standard		IEC 62314			
Weight		Approx. 1000 g		Approx. 1300 g	

Suffix code

Model	Code	Content
HSR-2SLD	<input type="checkbox"/> <input type="checkbox"/> <input type="checkbox"/>	2-Wire Breaking Alarm Output Solid State Relay (alarm open collector output)
HSR-2SE	<input type="checkbox"/> <input type="checkbox"/> <input type="checkbox"/>	2-Wire Isolated Low-Cost Solid State Relay (alarm bimetallic contact output)
Rated load current	25	25 A
	40	40 A
Rated load voltage	2	90 - 264 V a.c. (Low)
	4	90 - 480 V a.c. (High)
Operation method	Z	Zero Cross Switching (standard product)
	R	Random Switching

Solid State Relays

HSR-3SL series Slim Type 3-Phase Solid State Relays



Specification

Model	Low	HSR-3SLD152Z	HSR-3SLD252Z	HSR-3SLD402Z	
	High	HSR-3SLD154Z	HSR-3SLD254Z	HSR-3SLD404Z	
Appearance					
W×H×D (mm)	79.0×96.6×120.0			95.0×96.6×146.0	
LOAD	Load voltage range	Low	90 - 264 V a.c.		
		High	90 - 480 V a.c.		
	Peak Voltage (Non-repetition)	Low	600 V		
		High	800 V	1,200 V	
	Rated load current	15 A (40 °C)	25 A (25 °C)	40 A (25 °C)	
	Frequency	50/60 Hz			
	Surge current (8.3 ms non-repetition)	Low	170 A	260 A	420 A
		High	170 A	250 A	370 A
	Leakage current	Max. 20 mA			
	Output ON voltage dropping	Less than 1.6 V (RMS)			
INPUT	Rated Voltage	5 - 24 V d.c.			
	Operating voltage range	4 - 32 V d.c.			
	Impedance	Less than 4 kΩ			
	Operation voltage	More than 3 V d.c.			
	Reset voltage	Less than 1.5 V d.c.			
	Input current	Constant-current system: 10 mA (±3)			
Response Time	1/2 Cycle + max. 1 ms ("R" type below 1 ms)				
Insulating Resistance	500 V d.c., 100 MΩ (between the input / output and case)				
Dielectric strength	3000 V a.c. 60 Hz for 1 min				
Vibration resistance	10 - 55 Hz, double amplitude: 1.5 mm, X,Y, and Z direction for 2 hours				
Shock resistance	1000 m/s ² , X,Y,Z each axis 3 times				
Storage temperature	-30 ~ 90 °C				
Ambient temperature & humidity	-20 ~ 80 °C, 45 ~ 85 % RH (without icing)				
Weight	Approx. 1000 g		Approx. 1300 g		

Suffix code

Model	Code	Content
HSR-3SL	□ □ □ □	Slim Type 3-Phase Solid State Relay
Input Control Voltage	D	4 - 32 V d.c.
Rated load current	15	15 A
	25	25 A
	40	40 A
Rated load voltage	2	90 - 264 V a.c. (Low voltage)
	4	90 - 480 V a.c. (High voltage)
Operation method	Z	Zero Cross Switching (standard product)
	R	Random Switching

Heat sinks (HSP series / HSM series)

Model	HSP-10	HSP-20	HSP-40	HSM-70	HSM-110	HSM-150	HSM-200	HSM-250
		HSR-2□10□□	HSR-2□20□□	HSR-2□30□□ HSR-2□40□□	HSR-2□10□□	HSR-2□20□□ HSR-2□30□□	HSR-2□40□□ HSR-3□10□□	HSR-3□20□□ HSR-3□30□□
Appearance								
Capacity	10 A	20 A	30 A 40 A	10 A	20 A 30 A	40 A 10 A	20 A 30 A	40 A
Length	48 mm	80 mm	109 mm	70 mm	110 mm	150 mm	200 mm	250 mm



Solid State Relays

Heat sinks (HSN series)

Model	HSN-80	HSN-120	HSN-80-F	HSN-120-F
		HSR-2□50□□	HSR-2□70□□	HSR-3□50□□
With or without heat sink	Without	Without	With	With
Appearance				
Capacity	50 A	70 A	50 A	70 A
	-	-	-	-
Length	80 mm	120 mm	92X92X25T mm	92X92X25T mm

HSR-PD series Single-Phase Solid State Relays For PCB Substrate

Specifications





Model		HSR-PD032Z	HSR-PD052Z	HSR-PD082Z
Appearance				
W×H×D (mm)		35.0×19.0×8.0	37.5×23.2×10.6	35.0×36.7×20.0
LOAD	Rated load voltage	100 - 220 V a.c.		
	Load voltage range	90 - 240 V a.c.		
	Peak voltage (non-repetition)	600 V		
	Rated load current	3 A	5 A	8 A
	Frequency	50/60 Hz		
	Surge current	30 A	60 A	120 A
	Leakage current	Max. 10 mA		
Output ON voltage drop		Max. 1.6 V (RMS)		
INPUT	Rated voltage	5 - 24 V d.c.		
	Operating voltage range	4 - 32 V d.c.		
	Impedance	Max. 4 kΩ		
	Operating voltage	Min. 3 V d.c.		
	Return voltage	Max. 1.5 V d.c.		
Current input		Constant-current system: 10 mA (±3)		
Response time		1/2 cycle + max. 1 ms.		
Insulation resistance		500 V d.c., 100 MΩ (between the input / output and case)		
Dielectric strength		2500 V a.c. 60 Hz for 1 min		
Vibration resistance		10 - 55 Hz, double amplitude: 1.5 mm, X, Y, Z each axis 2 hours		
Shock resistance		100 m/s, X, Y, Z each axis 3 times		
Storage temperature		-30 ~ 90 °C		
Ambient temperature & humidity		-20 ~ 80 °C, 45 ~ 85 % RH (without condensation)		
Weight		Approx. 10 g	Approx. 22 g	Approx. 27 g





Suffix code

Model	Code	Content
HSR-P	□ □ □ □	Single-Phase Solid State Relay For PCB Substrate
Input voltage	D	4 - 32 V d.c.
Rated load current	03	3 A
	05	5 A
	08	8 A
Rated load voltage	2	90 - 240 V a.c. (low voltage)
Operation type	Z	Zero cross switching
	R	Random switching

■ DPS series Power Supplies

■ Specifications

Model	DPS-15S	DPS-30S	DPS-50S	DPS-75S
Appearance				
W×H×D (mm)	25.0×90.0×103.0	40.0×90.0×103.0	40.0×90.0×103.0	56.0×124.0×97.8
Power output	15 W	30 W	50 W	75 W
Input voltage	100 - 240 V a.c. (※ Designed voltage range: 85 - 264 V a.c.)			
Output voltage	5 V, 12 V, 15 V, 24 V			12 V, 24 V, 48 V
Voltage fluctuation range	±5 ~ 10 % (varies due to the internal VR)			
Protective circuit	Over voltage, Over current, Over heat, Short circuit			
Dielectric strength	2700 V a.c. for 1 min (between the input terminal and output terminal)			
Insulation resistance	Min. 100 MΩ, 500 V d.c. (between the input terminal and output terminal)			

Model	DPS-100S	DPS-120S	DPS-180S	DPS-240S
Appearance				
W×H×D (mm)	56.0×124.0×97.8	66.0×124.0×97.8	66.0×124.0×97.8	125.5×124.0×97.8
Power output	100 W	120 W	180 W	240 W (※ But, DPS-240S-12 : 216 W)
Input voltage	100 - 240 V a.c. (85 - 264 V a.c.)	100 - 120 V a.c. / 200 - 240 V a.c. ※ Auto-select input		
Output voltage	12 V, 24 V, 48 V		24 V, 48 V	12 V, 24 V, 48 V
Voltage fluctuation range	±5 ~ 10 % (varies due to the internal VR)			
Protective circuit	Over voltage, Over current, Over heat, Short circuit			
Dielectric strength	2700 V a.c. for 1 min (between the input terminal and output terminal)			
Insulation resistance	Min. 100 MΩ, 500 V d.c. (between the input terminal and output terminal)			











■ Suffix code







Model	Code	Content
DPS-	<input type="checkbox"/> <input type="checkbox"/> <input type="checkbox"/>	DPS Power Supply (DIN Rail Type)
Power output	15	15 W
	30	30 W
	50	50 W
	75	75 W
	100	100 W
	120	120 W
	180	180 W
	240	240 W (※ only DPS-240S-12 : 216 W)
Number of output voltage	S	1 Output (single output)
Output voltage classification	05	5 V d.c. (excluded DPS-75S, DPS-100S, DPS-120S, DPS-180S, DPS-240S)
	12	12 V d.c. (excluded DPS-180S)
	15	15 V d.c. (excluded DPS-75S, DPS-100S, DPS-120S, DPS-180S, DPS-240S)
	24	24 V d.c.
	48	48 V d.c. (excluded DPS-15S, DPS-30S, DPS-50S)



Power Supplies

■ TPS series Power Supplies

Specifications

Model	TPS-15S	TPS-30S	TPS-50S	TPS-55T	TPS-75S	TPS-100S
Appearance	 	 	 		 	
W×H×D (mm)	64.1×97.6×32.0	79.0×98.0×37.0	83.0×125.0×38.8	83.0×126.5×40.0	96.0×135.0×40.2	93.0×199.0×50.0
Power output	15 W	30 W	50 W	55 W	75 W	100 W
Input voltage	100 - 240 V a.c. (※ Designed voltage range: 88 - 264 V a.c.)					100 - 120 / 200 - 240 V a.c. (50 - 60Hz)
Output voltage	5 V, 12 V, 15 V, 24 V			A, B, C	5 V, 12 V, 15 V, 24 V	
Voltage fluctuation range	±5 ~ ±10 % (varies due to the internal VR)					
Protective circuit	Over current, Over voltage, Over heat, Short circuit					
Dielectric strength	2700 V a.c. for 1 min (between the input terminal and output terminal)					
Insulation resistance	Min. 100 MΩ, 500 V d.c. (between the input terminal and output terminal)					

Model	TPS-150S	TPS-220S	TPS-350S	TPS-450S	TPS-30D	TPS-50D
Appearance						
W×H×D (mm)	93.0×209.0×65.0	93.0×209.0×65.0	115.0×230.0×50.0	115.0×230.0×50.0	83.0×125.0×39.8	96.0×135.0×40.2
Power output	150 W	220 W	350 W	450 W	30 W	50 W
Input voltage	100 - 120 / 200 - 240 V a.c. (50 - 60Hz)			100 - 240 V a.c. (※ designed voltage range: 88 - 264 V a.c.)		
Output voltage	5 V, 12 V, 15 V, 24 V	12 V, 15 V, 24 V	12 V, 24 V, 48 V	12 V, 24 V, 48 V	24/05 V, 24/12 V, 24/24 V	
Voltage fluctuation range	±5 ~ ±10 % (varies due to the internal VR)					
Protective circuit	Over current, Over voltage, Over heat, Short circuit					
Dielectric strength	2700 V a.c. for 1 min (between the input terminal and output terminal)					
Insulation resistance	Min. 100 MΩ, 500 V d.c. (between the input terminal and output terminal)					

Model	TPS-75D	TPS-230D
Appearance		
W×H×D (mm)	83.0×125.0×38.8	115.0×230.0×50.0
Power output	75 W	230 W
Input voltage	100 - 240 V a.c. (※ Designed voltage range: 88 - 264 V a.c.)	100 - 120 / 200 - 240 V a.c. (50 - 60Hz)
Output voltage	24/05V, 24/12 V, 24/24 V	24/05 V, 24/12 V
Voltage fluctuation range	±5 ~ ±10 % (varies due to the internal VR)	
Protective circuit	Over current, Over voltage, Over heat, Short circuit	
Dielectric strength	2700 V a.c. for 1 min (between the input terminal and output terminal)	
Insulation resistance	Min. 100 MΩ, 500 V d.c. (between the input terminal and output terminal)	



Suffix code

TPS series

Model	Code	Content
TPS-	<input type="checkbox"/> <input type="checkbox"/> <input type="checkbox"/>	TPS Power Supply (enclosed type)
Power output	15	15W, 30W, 50W, 55W, 75W, 100W, 150W, 220W, 230W, 350W, 450W
Number of output voltage	S	1 Output
	D	2 Output (only for 30W, 50W, 75W, 230W)
	T	3 Output (only for 55W)
Output voltage classification	5	5 V d.c. (220W, 350W, 450W Exclude)
	12	12 V d.c.
	15	15 V d.c. (350W, 450W Exclude)
	24	24 V d.c.
	48	48 V d.c. (15W, 30W, 50W, 75W, 100W, 150W, 220W Exclude)
	2405	Output 1 : 24 V d.c. / Output 2 : 5 V d.c.
	2412	Output 1 : 24 V d.c. / Output 2 : 12 V d.c.
	2424	Output 1 : 24 V d.c. / Output 2 : 24 V d.c. (230W Exclude)
	A	Output 1 : 5 V d.c. / Output 2 : 12 V d.c. / Output 3 : -5 V d.c.
	B	Output 1 : 5 V d.c. / Output 2 : 12 V d.c. / Output 3 : -12 V d.c.
C	Output 1 : 5 V d.c. / Output 2 : 15 V d.c. / Output 3 : -15 V d.c.	

Control Switches

MR series (Aluminum guard type)







Model	PUSH BUTTON SWITCHES					
	Aluminum guard type			Plastic guard type		
	Flush Ø30	Flush Ø25	Extended Ø22	Flush Ø25	Extended Ø22	
Appearance						
Actuator code	MRF-A (Ø30)	MRF-N(Ø25)	MRF-R(Ø22)	MRF-K(Ø25)	MRF-T(Ø22)	
Model	ILLUMINATED PUSH BUTTON SWITCH					
	Aluminum guard type			Plastic guard type		
	Flush Ø30	Flush Ø25	Extended Ø22	Flush Ø25	Extended Ø22	ON / OFF
Appearance						
Actuator code	MRX-A (Ø30)	MRX-N(Ø25)	MRX-R(Ø22)	MRX-K(Ø25)	MRX-T(Ø22)	MRX-WM2
Model	PILOT LAMPS					
	Aluminum guard type			Plastic guard type		
	Flush Ø30	Flush Ø25	Extended Ø22	Flush Ø25	Extended Ø22	
Appearance						
Actuator code	MRP-A (Ø30)	MRP-N(Ø25)	MRP-R(Ø22)	MRP-K(Ø25)	MRP-T(Ø22)	
Model	SELECTOR SWITCHES					
	Aluminum guard type			Plastic guard type		
	Flush Ø30	Flush Ø25	Extended Ø22	Flush Ø25	Extended Ø22	
Appearance						
Actuator code	MRS-A (Ø30)	MRS-N(Ø25)	MRS-R(Ø22)	MRS-K(Ø25)	MRS-T(Ø22)	
Model	ILLUMINATED SELECTOR SWITCHES					
	Aluminum guard type			Plastic guard type		
	Flush Ø30	Flush Ø25	Extended Ø22	Flush Ø25	Extended Ø22	
Appearance						
Actuator code	MRT-A (Ø30)	MRT-N(Ø25)	MRT-R(Ø22)	MRT-K(Ø25)	MRT-T(Ø22)	
Model	KEY SELECTOR SWITCHES					
	Aluminum guard type					
	Flush Ø30	Flush Ø25	Extended Ø22			
Appearance						
Actuator code	MRK-A (Ø30)	MRK-N(Ø25)	MRK-R(Ø22)			





Control Switches

Model		EMERGENCY STOP BUTTON SWITCHES					
		Aluminum guard type			Plastic guard type		
		Flush Ø30	Flush Ø25	Extended Ø22	Flush Ø25	Extended Ø22	
Appearance						Temperature Controllers	
Actuator code	MRE-AM(Ø30)	MRE-NM(Ø25)	MRE-RM(Ø22)	MRE-KM(Ø25)	MRE-TM(Ø22)	Recorders	
Appearance						Digital Counter/ Timers	
Actuator code	MRE-AR(Ø30)	MRE-NR(Ø25)	MRE-RR(Ø22)	MRE-KR(Ø25)	MRE-TR(Ø22)	Analog Timers	
Model		ILLUMINATED EMERGENCY STOP BUTTON SWITCHES					
		Aluminum guard type			Plastic guard type		
		Flush Ø30	Flush Ø25	Extended Ø22	Flush Ø25	Extended Ø22	
Appearance						Multi Pulse Meters	
Actuator code	MRA-AM(Ø30)	MRA-NM(Ø25)	MRA-RM(Ø22)	MRA-KM(Ø25)	MRA-TM(Ø22)	Panel Meters	
Appearance						Peripheral Devices	
Actuator code	MRA-AR(Ø30)	MRA-NR(Ø25)	MRA-RR(Ø22)	MRA-KR(Ø25)	MRA-TR(Ø22)	Proximity Sensors	
Model		BUZZERS					
		Aluminum guard type			Plastic guard type		
		Flush Ø30	Flush Ø25	Extended Ø22	Flush Ø25	Extended Ø22	
Appearance						Photo Sensors	
Actuator code	MRB-A (Ø30)	MRB-N(Ø25)	MRB-R(Ø22)	MRB-K(Ø25)	MRB-T(Ø22)	Rotary Encoders	
Material	Contact material	AgSnO ₂					Thyristor Power Regulators
	Contact cover material	Polycarbonate (PC)					Solid State Relays
	Contact body material	Polycarbonate (PC)					Power Supplies
Mechanical features	Tightening torque	Installing screw : max. 1.96 N·m, Terminal screw : max. 0.78 N·m					Limit Switches
	Operating distance	5 mm ±0.2					
	Reflection time	Max. 3 ms					
Electrical features	Durability of actuator	Button: min 1 million times, Selector switch: min 50 thousand times					Micro Switches
	Dielectric strength	2000 V a.c. for 1 min					
	Contact resistance	Max. 50 mΩ (default)					
	Insulation resistance	Min. 100 MΩ 500 V d.c.					
	Switch rating	AC: 6 A 250 V a.c., DC: 10 A 24 V d.c.					
Light source	Power supply voltage	100 - 240 V a.c. (LED condenser voltage dropping type)					Signal Lights
		380 V a.c. (LED condenser voltage dropping type)					
		12 - 24 V a.c. / d.c. (LED resistance voltage dropping type)					
Environment condition	Ambient temperature & humidity	-20 ~ 55 °C, 35 ~ 85 % RH (without condensation)					Power Buzzers / Terminal Blocks Fuse Holders / Control Boxes
	Storage temperature	-40 ~ 85 °C					
	Shock resistance	300 m/s ² pulse cycle 11 ms					
	Vibration resistance	100 m/s ² , 10 Hz - 55 Hz, amplitude 0.75 mm (within 1 ms)					

Control Switches



■ AR series 

Model	PUSH BUTTON SWITCHES		ILLUMINATED PUSH BUTTON SWITCHES		PILOT LAMPS	
	Round	Round	Round	ON / OFF	AC	DC
Appearance						
Actuator code	ARF-F,B,P,G,H	ARF-S	ARX-P,G,H	ARX-S	ARP-A0	ARP-D0



Model	SELECTOR SWITCHES	ILLUMINATED SELECTOR SWITCHES	KEY SELECTOR SWITCHES	EMERGENCY PUSH BUTTON SWITCHES	
	Lever	Lever			
Appearance					
Actuator code	ARS-S	ART	ARK	ARE-B,P,R,K	ARE-4XR

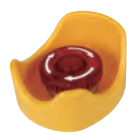

Allowable operating frequency	Mechanical	30 operations/min
	Electrical	30 operations/min
Insulation resistance		Min.100 MΩ
Dielectric strength		2000 V a.c. for 1 min (among common terminals)
Vibration	Malfunction Resistance	10 - 55 Hz double amplitude 3 mm (within 1 ms)
Shock	Mechanical Durability	Min.500 m/s
	Malfunction Resistance	Min.100 m/s
Life	Mechanical	500 thousand operations
	Electrical	100 thousand operations
Light source	Power supply voltage	100 - 240 V a.c. (LED condenser voltage dropping type)
		12 - 24 V a.c. / d.c. (LED resistance voltage dropping type)
Ambient temperature & humidity		-25 ~ 40 °C, 45 ~ 85 % RH (without condensation)
Storage temperature		-40 ~ 70°C

■ Emergency covers

Model	Emergency display plate	Model	Emergency protective guard
EN-36 (Ø 30)		EP-30 (Ø 30)	
EN-26 (Ø 22)		EP-22 (Ø 22)	

■ CR series

Model	PUSH BUTTON SWITCHES		PILOT LAMPS	SELECTOR SWITCHES	
Appearance					
Actuator code	CRF (non-illuminated)	CRX (illuminated)	CRP	CRS (non-illuminated)	CRT (illuminated)







Model	EMERGENCY SWITCHES		KEY SELECTOR SWITCHES	BUZZERS
Appearance				
Actuator code	CRE (non-illuminated)	CRA (illuminated)	CRK	CRB

Contact configuration	1a1b				
Operation of contact	Slow-action				
Installing panel thickness	1 ~ 6 mm (without the additional accessories)				
Rated voltage / Current consumption	100 - 240 V a.c. / Max. 4.4 VA				
	380 V a.c. / Max. 2.7 VA				
	12-24 V d.c. / Max. 18 mA				
Allowable operating frequency	Mechanical	Max. 30 operations/min			
	Electrical	Max. 30 operations/min			
Insulation resistance	Min.100 MΩ				
Dielectric strength	1500 V a.c. 50/60 Hz for 1 min				
Vibration	Malfunction Resistance	10 - 55 Hz double amplitude width 3 mm			
Shock	Mechanical durability	Min.500 m/s ²			
	Malfunction resistance	Min.100 m/s ²			
Life	Mechanical	More than 1 million operations			
	Electrical	More than 100 thousand operations			
Ambient temperature & humidity	-25 ~ 40 °C, 45 ~ 85 % RH				
Storage temperature	-40 ~ 60°C				

- Temperature Controllers
- Recorders
- Digital Counter/ Timers
- Analog Timers
- Multi Pulse Meters
- Panel Meters
- Peripheral Devices
- Proximity Sensors
- Photo Sensors
- Rotary Encoders
- Thyristor Power Regulators
- Solid State Relays
- Power Supplies
- Control Switches / Combination Display Lights
- Power / Main / Cam Switches
- Limit Switches
- Micro Switches
- Foot / Mono Lever / Pendant Switches
- Signal Lights
- Power Buzzers / Terminal Blocks Fuse Holders / Control Boxes

Control Switches

SR series (Ø16 Control Switches)

Model	SRF	SRX	SRP	SRS	SRK	SRE
	PUSH-BUTTON	ILLUMINATED PUSH-BUTTON	PILOT-LAMP	SELECTOR	KEY-SELECTOR	EMERGENCY RESET
Appearance						
Ratings	5 A, 250 V a.c.					
Display color	Red, Yellow, Green, Blue, White					
Contact	AgNi					
Insulation resistance	Min.100 MΩ					
Dielectric strength	1500 V a.c. 50/60 Hz for 1 min					
Vibration	10 - 55 Hz, double amplitude 0.75 mm					
Operation	Mechanical	Min. 500,000 times		Min. 100,000 times		
	Electrical	Min. 70,000 times				
Ambient temperature & humidity	-20 ~ 50 °C, 45 ~ 88 % RH					
Storage temperature	-40 ~ 70 °C					

INCANDESCENT LAMP RATINGS

Power voltage	Power consumption
6.3 V a.c. / d.c.	60 mA
6.3 V a.c. / d.c.	40 mA
6.3 V a.c. / d.c.	20 mA

LED RATINGS

Power voltage	Power consumption
12 V a.c. / d.c.	20 mA
24 V a.c. / d.c.	15 mA

CR40 series LED Rectangular Lamps

Specifications

Model	CR40		
Appearance			
Voltage	100 - 240 V a.c.	380 V a.c.	12 - 24 V d.c.
Current consumption	Max. 4.4 VA	Max. 2.7 VA	Max. 18 mA
Cap color	Red, Yellow, Green, Blue, White		
Insulation resistance	Min. 100 MΩ (Within current carrying part & non current carrying part)		
Dielectric strength	1500 V a.c. for 1 min		
LED life	Above 100,000 Hours		
Ambient temperature & humidity	-20 ~ 40 °C, 45 ~ 85 % RH		
Storage temperature	-25 ~ 55 °C		

Suffix code

Model	Code	Content
CR40	<input type="checkbox"/> <input type="checkbox"/>	CR40 Series, LED Indicator
Power voltage	A0	110 - 240 V a.c.
	A3	380 V a.c.
	D0	12 - 24 V d.c.
Color of indicator	R	Red, Yellow, Green, Blue, White

Combination Display Lights

CD series LED Combination Display Lights

Specifications





Model	CD		
Appearance			
Voltage	24 V d.c.	110 / 220 V a.c.	110 / 125 V d.c.
Cap color	Red, Yellow, Green, White, Orange		
Insulation resistance	Min. 100 MΩ (at 500 V d.c.)		
Dielectric strength	1500 V a.c. for 1 min		
Consumption power	0.68 W (24 V d.c., 28 mA)		
LED	24 V d.c.		
Life	50,000 hours (24 V d.c., 25 °C)		
Ambient temperature & humidity	-20 °C ~ 40 °C, 45 ~ 85 % RH		
Storage temperature	-25 ~ 55 °C		

※ Note: CD-S□ (30 X 30 mm) and CD-R□ (30 X 40 mm)

Suffix code

Model	Code	Content	
CD	<input type="checkbox"/> <input type="checkbox"/> <input type="checkbox"/> <input type="checkbox"/>	CD Series Combination Display Light	
Standard type	S	Square type (30 mm ×30 mm)	
	R	Rectangular type (30 mm ×40 mm)	
Power voltage	A	24 V a.c. / d.c.	Without voltage dropping
	B	100 ~ 125 V d.c.	Resistance voltage dropping type
	C	110 V a.c.	Condenser voltage dropping type
	D	220 V a.c.	
LED indicating color	R	Red	
	G	Green	
	Y	Yellow	
	W	White	
	O	Orange	
	A	Blue	
Surface composition	2	1 column ~ 10 column (height)	
	6	1 row ~ 20 rows (Width)	

HY-500 series Power button switches

Model	RATINGS	USE
 EXPOSED	HY-510 3P 250 V a.c. 15A	Electromotor 3 phase power supply ON, OFF
 FLUSH	HY-512 2P 250 V a.c. 15A	1 phase Electromotor ON, OFF
	HY-513 3P 250 V a.c. 15A	Electromotor for 3 phase power supply ON, OFF
	HY-514 3P 250 V a.c. 15A	Electromotor for 3 phase power supply ON, OFF
 EXPOSED	HY-516 3P 250 V a.c. 15A	Electromotor for 3 phase power supply Direct/reverse revolution for stop 1 phase, 3 phase, right/left for revolution
 EXPOSED	HY-517 3P 250 V a.c. 15A	Electromotor 1 phase, 3 phase ON, OFF



Power Push Button Switches

■ BE series Power button switches

● STEEL CASE (BE)

Model	RATINGS	ELECTROMOTOR CAPACITY(KW)		CONTACT TERMINAL	LITERAL DISPLAY	MATERIAL OF CASE
		1Ø100/110V	3Ø200/220V			
 STEEL CASE EXPOSURE	BE 230	3P 30A	-	3.7	M5	ON(black) OFF(red) Cold workable steel plate

● WATER PROOF (BEW, BEWT)

Model	RATINGS	ELECTROMOTOR CAPACITY(KW)		CONTACT TERMINAL	LITERAL DISPLAY	MATERIAL OF CASE
		1Ø100/110V	3Ø200/220V			
 WATER PROOF	BEW 215	3P 15A	0.4	2.2	M4	Burning resist ABS
	BEW 230	3P 30A	-	3.7	M5	
 ADVANCED WATER PROOF	BEWT 215	3P 15A	0.4	2.2	M4	
	BEWT 315	3P 15A	0.4	2.2	M4	

■ MAS series Main switches

■ Specifications





Appearance	Suffix code	Rated insulation voltage	Rated current	Material
	MAS-025-A/B	690 V a.c.	25 A	Anti-flammable
	MAS-063-A/B		63 A	
	MAS-125-A/B		125 A	

■ Suffix code

Model	Code	Content
MAS-	<input type="checkbox"/> <input type="checkbox"/>	Main Switch
Rated current	025	25 A a.c. ※ IP64 (IEC 60529)
	063	63 A a.c. ※ IP55 (IEC 60529)
	125	125 A a.c. ※ IP65 (IEC 60529)
Color classification	A	Emergency stop type (Yellow guard / Red handle)
	B	Standard type (White guard / Black handle)

■ HY-SQ5/255/305/MRK series Cam switches

■ Specifications

Model		Square type	Round type	Handle control type	Circle type	Square key type	
Appearance							
Contact part	Rated insulation voltage	600 V					
	Rated current	10 A, 20 A					
	Contact structure	2 cut-off slow-make 1- stage 2 contacts, max. 6 positions (max. 3 positions for the momentary version)					
	Operation method	Each position fixed, spring return type					
	Selection angle	30 °, 45 °, 60 °, 90 °					
	Positions	2 positions ~ 12 positions, 2 positions ~ 4 positions					
	Insulation resistance	100 MΩ (500 V d.c.)					
	Dielectric strength	2,500 V a.c. for 1 min					
	Life	Mechanical	Min. 500 thousand operations				
		Electrical	Min. 100 thousand operations, MRK: Min. 200 thousand operations				
Ambient temperature		-20 ~ 50 °C					
Degree of protection		305, 255 (round type): IP65 (IEC 60529), SQ5 (square type): IP40 (IEC 60529)					
Part materials	Body	Heat-resistant Polycarbonate (PC)					
	Cam	Acetal					
	Contacts	Ag + Ni					
	Terminals	Brass					
	Bolts	SWRM					
	Springs	Stainless steel					
Handle		Phenol resin					

■ Suffix code

Model	Code						Content
Appearance	<input type="checkbox"/>	<input type="checkbox"/>	<input type="checkbox"/>	<input type="checkbox"/>	<input type="checkbox"/>	<input type="checkbox"/>	Cam switch
	HY-SQ5						Square type cam switch
	HY-255						Ø 25 type cam switch
	HY-305						Ø 30 type cam switch
Contact type	S						Square type (standard type)
	C						Round type (for HY-SQ5)
Handle type	H						Standard type (standard industrial machine)
	R						Switchboard type (A/S, V/S)
	P						Control switch type (C/S)
Position selection	2						2 positions
	3						3 positions
	4						4 positions
	5						5 positions
	6						6 positions
Number of contact unit (Number of rows)	1						1 row
	2						2 rows
	3						3 rows
	4						4 rows
	5						5 rows
	6						6 rows
Standard circuit diagram serial number						0 1	01 ~ 99

※ A/S: ammeter converting switch, V/S: voltmeter converting switch

※ Possible to manufacture 20 A, 250 V product only within the square type contact structure

Model	Code						Content
HY-MRK	4	2	0	2			Key cam switch
Contact formation							Labeled the serial number (refer to the standard circuit diagram)

Cam Switches

■ SQ4 Cam switches

■ Specifications







Model	SQ4	
Appearance		
Rated Insulation voltage (Ui)	690 V a.c.	
Dielectric strength (Uimp)	2500 V a.c.	
Rated Electro Current (Ith)	16 A	
Rated Service Voltage (Ie)	16 A	
Rated Service Current (Ie)	480 V a.c.	
Mechanical Life Expectancy	300,000 Times	
Electrical Life Expectancy	AC: 200,000 Times, DC: 100,000 Times	
Ambient temperature & humidity	-25 ~ 55 °C, max. 90 % RH	
Altitude	Max. 2000 m	
Degree of protection	IP65 (IEC 60529)	
Pollution degree	3	
Component Materials	Body	NY66 GF15 % Level of Resistance to flame
	Cam	ACETAL
	Contact	AgNi
	Terminal	Brass
	Bolt	Iron (Galvanizing)
	Spring	Stainless (STS)
	Handle	Level of PC Resistance to flame

■ Suffix code

Model	Code	Content
SQ4-	<input type="checkbox"/> <input type="checkbox"/> <input type="checkbox"/> <input type="checkbox"/> <input type="checkbox"/> <input type="checkbox"/> <input type="checkbox"/> <input type="checkbox"/>	Cam switch
Installation	F	Four holes of panel mounting
Contact type	S	Square type (Standard type)
Handle type	H	Standard type (Standard industrial machine)
	R	Switch-board type (A/S, V/S)
Notches selection	2	2 positions selection
	3	3 positions selection
	4	4 positions selection
	5	5 positions selection
	6	6 positions selection
	7	7 positions selection
Number of contact unit (Number of rows)	1	1 Row
	2	2 Rows
	3	3 Rows
	4	4 Rows
	5	5 Rows
	6	6 Rows
Serial number (Contact formation diagram)	0 1	Label the serial number of contact formation

✳ In case of standard item, please check circuit diagram









■ Limit Switches

Model	ROLLER PLUNGER		TOP BALL PLUNGER		VARIABLE ROLLER LEVER		VARIABLE ROD		ROLLER LEVER		SPRING WIRE		FORK ROLLER LEVER	
	M902	LM902	M903	LM903	M904	LM904	M907	LM907	M908	LM908	M909	LM909	M908R	M908L
Appearance														
Operation speed	0.1 - 1 m/s													
Frequency	Mechanical	120 / minute												
	Electrical	20 / minute												
Insulation resistance	Min. 100 MΩ (at 500 V d.c.)													
Dielectric strength	1000 V a.c. 50/60 Hz for 1 min (between charging part), 1500 V a.c. 50/60 Hz for 1 min (between discharging part)													
Contact resistance	Max. 100 MΩ (initial)													
Vibration	Malfunction Resistance	10 - 55 Hz double amplitude width 1.5 mm												
Shock	Mechanical Durability	Min. 1000 m/s² (Min. 100G)												
	Malfunction Resistance	Min. 300 m/s² (Min. 30G)												
Life	Mechanical	Min. 1 Millions operations												
	Electrical	Min. 0.3 Million operations												

● RATINGS

RATED VOLTAGE (V)	NON-INDUCTIVE LOAD (A)				INDUCTIVE LOAD (A)			
	Resistive LOAD		RAMP		INDUCTIVE LOAD		MOTOR LOAD	
	NC	NO	NC	NO	NC	NO	NC	NO
AC	125	15	3	1.5	10	3	1.5	
	250	10	2	1	6	2	1	
	480	3	1.5	0.8	2	1.5	0.75	
DC	8	15	6	3	10	-	-	
	14	15	6	3	10	-	-	
	30	6	4	3	5	-	-	
	125	0.4	0.2	0.2	0.05	-	-	
	250	0.2	0.1	0.1	0.03	-	-	

■ Mini Limit Switches







Model	Roller Plunger type	CrossRoller Plunger type	Top Plunger type	Roller Adjustable Lever	Rubber Roller Adjustable Lever	Adjustable Rod Lever	Roller Lever	Coil spring type
	HY-L802	HY-L802C	HY-L803	HY-L804	HY-L804RE	HY-L807	HY-L808	HY-L809
Appearance								
Frequency	Mechanical	120 / minute						
	Electrical	30 / minute						
Insulation resistance	Min. 100 MΩ (At 500 V d.c.)							
Dielectric strength	Between non-continuous terminal : 1500 V a.c. 50/60 Hz for 1 min Between terminal & non-current carrying metal part: 2000 V a.c. 50/60 Hz for 1 min							
Contact resistance	Max. 25 MΩ (initial), max. 100 MΩ (after testing)							
Vibration	Malfunction Resistance	Min. 10 - 55 Hz double amplitude width 1.5 mm						
Shock	Mechanical Durability	Min. 300m/s² (30G above)						
	Malfunction Resistance	Min. 100m/s² (10G above)						
Life	Mechanical	Min. 1 million operations (Switching frequency 120 / minute)						
	Electrical	Min. 0.1 millions operations (Switching frequency 20 / minute, at rated load)						
Ambient temperature & humidity	-10 ~ 70 °C 95 % RH below (20 °C)							

● RATINGS

RATED VOLTAGE	LOAD	Resistive LOAD (cosφ≅1)	INDUCTIVE (cosφ≅0.4)
	125 V a.c.		5 A
250 V a.c.		5 A	2 A
125 V d.c.		0.4 A	0.1 A

Limit Switches









N Type Limit Switches

Model		Roller Plunger	Push Plunger	Roller Arm	Rubber Roller Lever	Roller Adjustable Lever	Adjustable Rod Lever	Roller Lever
		LS-802N	LS-803N	LS-803RN	LS-804RE	LS-804N	LS-807N	LS-808N
Appearance								
Frequency	Mechanical	120 / minute						
	Electrical	30 / minute						
Insulation resistance		Min. 100 MΩ (at 500 V d.c.)						
Contact resistance		Max. 25 MΩ (initial)						
Dielectric resistance		1000 V a.c. 50/60 Hz for 1 min, 2000 V a.c. 50/60 Hz for 1 min						
Vibration	Malfunction Resistance	10 - 55 Hz double amplitude width 1.5 mm						
Shock	Mechanical Durability	Min. 1000 m/s (Min. 100G)						
	Malfunction Resistance	Min. 300 m/s (Min. 30G)						
Life	Mechanical	Min. 1 million operations						
	Electrical	Min. 0.1 million operations						
Ambient temperature & humidity		-10 ~ 70 °C, max. 95 % RH (20 °C)						

RATINGS

RATED VOLTAGE (V)		NON-INDUCTIVE Load (A)		INDUCTIVE LOAD (A)			
		Resistive LOAD		INDUCTIVE LOAD		MOTOR LOAD	
		NO	RAMP	NO	NC	NO	NC
AC	125	6	2	6		3	
	250	6	1.5	6		1.5	
DC	8	6	4	6		4	
	14	6	4	6		4	
	30	4	2.5	4		2.5	
	125	0.4	0.1	0.4		0.1	
	250	0.2	0.05	0.2		0.05	

ZCN Type Limit Switches















Model		Plunger type	Hinge roller short lever type	Hinge roller long lever type	Hinge short lever type	Hinge lever type	Hinge long lever type	Vertical roller plunger type	Horizontal roller plunger type	Resin road spring type
		P5010	R504A	R504C	L507A	L507C	L507D	PR508V	PR508H	L509
Appearance										
Operation speed		0.1 mm - 0.5 m/s								
Frequency	Mechanical	120 / minute								
	Electrical	20 / minute								
Insulation resistance		Min. 100 MΩ (at 500 V d.c.)								
Contact resistance		Max. 25 MΩ (initial), max. 100 MΩ								
Dielectric strength		Between charging part: 1000 V a.c. 50/60 Hz for 1 min, between discharging part: 1500 V a.c. 50/60 Hz for 1 min								
Vibration	Malfunction Resistance	10 - 55 Hz double amplitude width 1.5 mm								
Shock	Mechanical Durability	Min. 1000 m/s (Min. 100G)								
	Malfunction Resistance	Min. 300 m/s (Min. 30G)								
Life	Mechanical	Min. 1 million operations								
	Electrical	Min. 0.3 million operations								
Ambient temperature & humidity		-10 ~ 80 °C Max. 25 ~ 95 % RH								

RATINGS

RATED VOLTAGE (V)		NON-INDUCTIVE LOAD (A)		INDUCTIVE LOAD (A)					
		RESISTIVE LOAD		INDUCTIVE LOAD		MOTOR LOAD			
		N.C	N.O	N.C	N.O	N.C	N.O		
AC	125	15		10		3		1.5	
	250	10		6		2		1	
	600	3		2		1.5		0.75	
DC	8	15		10		-		-	
	14	15		10		-		-	
	30	6		5		-		-	
	125	0.4		0.05		-		-	
	250	0.2		0.03		-		-	

Micro Switches

Micro Switches

Model		Panel mounting type	Spring single push button type	Pin push button type	Spring stander push button type	Hinge roller single lever type
		HY-P701A (Z4G1P05B)	HY-P701B (Z4G1P09B)	HY-P701C (Z4G1P01B)	HY-P701D (Z4G1P03B)	HY-R704A (Z4G1L07B)
Appearance						
Model		Hinge roller middle lever type	Hinge roller lever type	2 positions roller lever type	Single position lever type	Middle lever type
		HY-R704B	HY-R704C (Z4G1L03B)	HY-R704-2W	HY-L707A	HY-L707B
Appearance						
Model		Hinge lever type	Special lever type	Hinge special lever type	Roller panel mounting type (Vertical)	Roller panel mounting type
		HY-L707C (Z4G1L01B)	HY-L707D	HY-L707S	HY-PR708A	HY-PR708B (Z4G1P07B)
Appearance						
Operation speed		0.1 mm - 1 m/s				
Allowable operating frequency	Mechanical	50 - 300 operations/min				
	Electrical	20 operations/min				
Insulation resistance		Min. 100 MΩ (at 500 V d.c.)				
Contact resistance		Max. 50 MΩ (initial), max. 2 Ω (after testing)				
Vibration resistance		10 - 55 Hz double amplitude 0.75mm				
Shock	Mechanical Durability	Min. 1000 m/s (Min. 100 G)				
	Malfunction Resistance	Min. 300 m/s (Min. 30 G)				
Dielectric strength		1000 V a.c. 50/60 Hz for 1 min (between charging part) 1500 V a.c. 50/60 Hz for 1 min (between discharging part)				
Life	Mechanical	Min. 1 Millions Operations (Switching frequency 120 / minute)				
	Electrical	Min. 0.3 Millions Operations (Switching frequency 20 / minute, at rated load)				
Net weight		31.5 ~ 59.5 g				
Rated current		10 A 250 V a.c. (resistive load)				

Temperature Controllers

Recorders

Digital Counter/ Timers

Analog Timers

Multi Pulse Meters

Panel Meters

Peripheral Devices

Proximity Sensors

Photo Sensors

Rotary Encoders

Thyristor Power Regulators

Solid State Relays

Power Supplies

Control Switches / Combination Display Lights

Power / Main / Cam Switches

Limit Switches

Micro Switches

Foot / Mono Lever / Pendant Switches



Signal Lights



Power Buzzers / Terminal Blocks Fuse Holders / Control Boxes

Foot Switches

■ HY-100 series Foot switches (CCC)

Specifications

Model	HY-101	HY-102N
Appearance		
Rated voltage	250 V a.c., 10 A	250 V a.c., 10 A
Internal switch	SMV-61A-07H	SMV-61A-07H
Material of case	ABS resin	AL Die-casting



Model	HY-103N	HY-104	HY-105
Appearance			
Rated voltage		250 V a.c., 10 A	
Internal switch	HY-P701B	HY-P701B	HY-P701B
Material of case	AL Die-casting		Aluminium, green paint

Suffix code

Model	Code	Content
HY-10	<input type="checkbox"/>	Foot Switch
Appearance	1	Plastic foot switch
	2N	Aluminum foot switch
	3N	Middle size aluminum foot switch
	4	Large size aluminum foot switch
	5	Large size aluminum foot switch

■ LEL/LES series Mono lever switches (CCC)

Specifications

Model	LEL (long lever)	LES (short lever)
Appearance		
Rated insulation voltage	600 V	
Rated current	3 A 250 V a.c.	
Contact structure	2 cut-off slow-make 1- stage 2 contacts, max. 4 positions	
Insulation resistance	100 MΩ (500 V d.c.)	
Dielectric strength	2500 V a.c. for 1 min (between charging part and discharging part)	
Contact resistance	Max. 20 MΩ	
Life	Mechanical	Min. 500 thousand operations
	Electrical	Min. 100 thousand operations
Ambient temperature & humidity	-20 ~ 50 °C, 45 ~ 85 % RH (without condensation)	

Suffix code

Model	Code	Content
LE	<input type="checkbox"/> <input type="checkbox"/> <input type="checkbox"/>	Mono Lever Switch
Lever selection	L	Long lever
	S	Short lever
Stage selection	01	1 position
	02	2 positions
	03	3 positions
	04	4 positions
Returning type	1	Auto returning
	2	Manual returning

Pendant Switches

HY-1020 series Pendant Switches 

Specifications

Model	HY-1022 (2 BUTTON)	HY-1024 (4 BUTTON)	HY-1026 (6 BUTTON)	HY-1028 (8 BUTTON)	HY-1029 (10 BUTTON)
Appearance					
Protection construction	IP66 (IEC 60529), emergency switch type excluded				
Materials	Case	High impact ABS resin			
	Screws	Cover Bolt (stainless screw)			
	Colors	Button packing	Special rubber (black)		
	Wire holder	Special rubber (black)			
Insulation resistance	Min. 100 MΩ (at 500 V d.c.)				
Dielectric strength	2000 V a.c. for 1 min (between charging part and discharging part)				
Ambient temperature & humidity	-15 ~ 45 °C, 45 ~ 85 % RH (without condensation)				

Suffix code





Model	Code				Content	
HY-102	<input type="checkbox"/>	<input type="checkbox"/>	<input type="checkbox"/>	<input type="checkbox"/>	Pendant Switch	
Lever selection	2				Emergency switch excluded	2 buttons (1 unit)
	4					4 buttons (2 units)
	6					6 buttons (3 units)
	8					8 buttons (4 units)
	9					6 buttons (3 units) + 3 switches
Emergency button					No	
	S				Yes	
Switch unit type	A	A	A	A	2 Buttons / unit	102A contact unit
	B	B	B	B		102B contact unit
	C	C	C	C		102C contact unit
	D	D	D	D		102D contact unit
	E	E	E	E		102E contact unit

※Within the switch unit type, AAAA indication means 4 switch units.

Pendant Switches

■ HY-P series Pendant Switches

■ Specifications











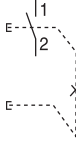
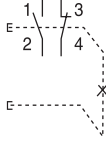

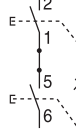
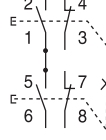

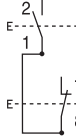
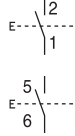
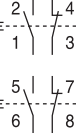

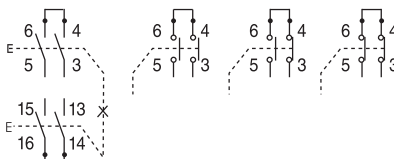
Model	HY-P1022 / HY-P1022S HY-P1022S1	HY-P1024 / HY-P1024S HY-P1024S1	HY-P1026 / HY-P1026S HY-P1026S1	HY-P1028 / HY-P1028S HY-P1028S1	HY-P1029 / HY-P1029S HY-P1029S1
		2 buttons / 2 buttons + emergency switch	4 buttons / 4 buttons + emergency switch	6 buttons / 6 buttons + emergency switch	8 buttons / 8 buttons + emergency switch
Appearance					
Degree of protection	IP65 (IEC 60529) emergency switch type included				
Materials	Case	High impact ABS resin			
	Contacts	AgSnO ₂			
Colors	Wire holder	Special rubber (black)			
	Insulation resistance	100 MΩ (500 V d.c.)			
Dielectric strength	2000 V a.c. for 1 min (between conductive part terminal and exposed unfilled metal)				
Ambient temperature & humidity	-10 ~ 45 °C, 45 ~ 85 % RH (without condensation)				

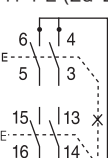
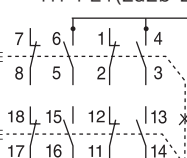
■ Suffix code





Model	Code								Content		
HY-	<input type="checkbox"/>	<input type="checkbox"/>	<input type="checkbox"/>	<input type="checkbox"/>	<input type="checkbox"/>	<input type="checkbox"/>	<input type="checkbox"/>	<input type="checkbox"/>	Pendant Switch		
Number of buttons	P1022	X	X	X		X	X	X	2 buttons (1 unit)		
	P1024	X	X	X			X	X	4 buttons (2 units)		
	P1026		X	X				X	6 buttons (3 units)		
	P1028		X	X					8 buttons (4 units)		
	P1029							X	6 buttons (3 units) + 3 switches		
Emergency switch									None		
	S								1b contact (default)		
	S1								1a1b contact (order made)		
Contacts and control switches									None		
	P	P	P						MRP-RA0	MR control switches *The switch order and type may change according to the order specifications	
	H	H	H						MRF-RM1		
	M	M	M						MRS-R2A1		
	Y	Y	Y						MRS-R3A2		
	K	K	K						MRK-R2A1		
				A	A	A	A		HY-PA	1a	Default Order made
				B	B	B	B		HY-PB	1a-1a	
				C	C	C	C		HY-PC	1a-1b	
				D	D	D	D		HY-PD	2a-2a	
				E	E	E	E		HY-PE	2a-2a	
				A1	A1	A1	A1		HY-PA1	1a1b	
				B1	B1	B1	B1		HY-PB1	1a1b-1a1b	
				C1	C1	C1	C1		HY-PC1	1a1b-1a1b	
				E1	E1	E1	E1		HY-PE1	2a2b-2a2b	
			F	F	F	F		HY-PF	2a		
			F1	F1	F1	F1		HY-PF1	2a2b		
Other	Additional accessories can be added according to the order specifications								TOGGLE SWITCH		
									VOLUME (1K,2K,3K,7[E])		
									Ø 8~16 controller switches		

※ Except where X is indicated in the model configuration

Contact units

Model	Appearance	Contact configuration	Information
HY-1020 series: 102 A HY-P series: HY-PA	※ On/off switch 	102A10 (1a) HY-PA (1a)  102A11(1a1b) HY-PA1(1a1b) 	For on/off operation power, etc. To close and hold, press the top button (ON) . To open, press the bottom button (OFF).
HY-1020 series: 102 B HY-P series: HY-PB	※ Interlock operation switch 	102B20 (1a-1a) HY-PB(1a-1a)  102B22(1a1b-1a1b) HY-PB1(1a1b-1a1b) 	For general circuits (up/down/east/west, etc.) It does not support the simultaneous operation of the 2 buttons with the seesaw-type mechanical interlock.
HY-1020 series: 102 C HY-P series: HY-PC	※ General operation switch 	102C11(1a-1b) HY-PC(1a-1b)  102C20 (1a-1a) HY-PC1(1a-1a)  102C22(1a1b-1a1b) HY-PC2(1a1b-1a1b) 	For general circuits. It supports the simultaneous operation of the 2 buttons because there is no mechanical interlock.
HY-1020 series: 102 D HY-P series: HY-PD	※ 2-stage switch 	102D (2a-2a), HY-PD (2a-2a) 	For speed control and 2-circuit control The contacts are divided into two stages. It does not support the simultaneous operation of the 2 buttons with the seesaw-type mechanical interlock.
HY-1020 series: 102 E HY-P series: HY-PE	※ Interlock operation switch 	102E20 (2a-2a) HY-PE (2a-2a)  102E22(2a2b-2a2b) HY-PE1(2a2b-2a2b) 	For general circuits. 2a-2a / 2a2b-2a2b contacts. It does not support the simultaneous operation of the 2 buttons with the seesaw-type mechanical interlock.
HY-1020 series: 102 F HY-P series: HY-PF		102F10(1a) HY-PF(1a)  102F01(1b) HY-PF1(1b)  102F11(1a1b) HY-PF2(1a1b)  102F20(2a) HY-PF3(2a)  102F21(2a1b) HY-PF4(2a1b)  102F22(2a2b) HY-PF5(2a2b) 	For general circuits. You can freely assemble and configure it according to the independent 1 contact switch. Up to 2a2b contacts (1a, 1b, 1a1b, 2a1b, 2a2b)

Contact units (emergency switches)



Model	Appearance	Contact configuration	Information
HY-1020series: 102 S			Press the emergency switch (red), to hold. Turn into the direction of the printed arrow.
HY-Pseries: HY-PS		HY-PS  HY-PS1 	

Temperature Controllers
Recorders
Digital Counter/ Timers
Analog Timers
Multi Pulse Meters
Panel Meters
Peripheral Devices
Proximity Sensors
Photo Sensors
Rotary Encoders
Thyristor Power Regulators
Solid State Relays
Power Supplies
Control Switches / Combination Display Lights
Power / Main / Cam Switches
Limit Switches
Micro Switches
Foot / Mono Lever / Pendant Switches
Signal Lights
Power Buzzers / Terminal Blocks Fuse Holders / Control Boxes

Signal Lights

STS series Sign Towers  

Specifications



Model	STS 040	STS 060	STS 080
Appearance			
Size	Ø 40	Ø 60	Ø 80
Mount	Plastic round bracket L type bracket Elbow bracket (option)	Plastic round bracket L type bracket Elbow bracket (option)	Plastic round bracket L type bracket Elbow bracket (option)
Rated voltage	24 V a.c. / d.c. (12 V: order-made)		
Number of stacks	1, 2, 3, 4, 5 stacks		
Color	Red, Yellow, Green, Blue, White		
Power consumption	Max. approx. 6 W for 5 stacks (0.9 W per each stack)		
Drive	Relay, NPN, PNP transistor open collector drive		
Material	Heat resistant ABS		

Suffix code





Model	Code	Content
STS	<input type="checkbox"/> <input type="checkbox"/> <input type="checkbox"/> <input type="checkbox"/>	Sign Tower With Continuous Light
Diameter size	040	Ø40 cylinder type
	060	Ø60 cylinder type
	080	Ø80 cylinder type
Power voltage	C51	24 V a.c. / d.c. 50/60 Hz (dual usage)
	D41	12 V a.c. / d.c. 50/60 Hz (dual usage)
Module colors	1	1 stack (red)
	2	2 stack (red, green)
	3	3 stack (red, yellow, green)
	4	4 stack (red, yellow, green, blue)
	5	5 stack (red, yellow, green, blue, white)
Supporter selection	M	Plastic round supporter (standard)
	L	L type bracket
Optional		Elbow type supporter (EPM)

※ 12 V a.c. / d.c.: order-made

Supporter

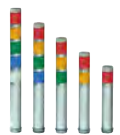
Model	M Type Plastic round supporter (standard)	L Type bracket	EPM Elbow type supporter (option)
Appearance			

Specifications

Model	STL 025	STL 040	STL 060	STL 080
Appearance				
Size	Ø 25	Ø 40	Ø 60	Ø 80
Function	Continuous light only	A : Continuous light, F : Continuous light, Flashing light, Buzzer		
Rated voltage	24 V d.c.	24 V a.c. / d.c., 100 - 240 V a.c. 50/60 Hz		
Number of stacks	1, 2, 3, 4, 5 stacks			
Drive	Relay, NPN, PNP transistor Open Collector Drive 24 V d.c. / 24 V a.c.	Relay, NPN, PNP transistor open collector drive 24 V a.c. / V d.c., 100 - 240 V a.c.		
Mount	L type bracket (ST-AG: sold separately)	Direct, Plastic round bracket, STM-84 (option), STM-105 (option), Elbow type bracket(EPM) (option)		
Color	Red, Yellow, Green, Blue, White			
Power consumption	Max. approx. 4 W for 5 stacks (0.6W per each lamp)	Max. approx. 8 W for 5 stacks (1.2 W per each lamp)		
Buzzer	-	75 dB (1 m)	85 dB (1 m)	

Suffix code

Model	Code	Content
STL	<input type="checkbox"/> - <input type="checkbox"/> <input type="checkbox"/> <input type="checkbox"/> <input type="checkbox"/>	Sign tower
Diameter size	025	Ø25 cylinder type
Power voltage	D51	24 V d.c. (LED light source)
Module colors	1	1 stack (red)
	2	2 stack (red, green)
	3	3 stack (red, yellow, green)
	4	4 stack (red, yellow, green, blue)
	5	5 stack (red, yellow, green, blue, white)
Supporter selection	N	NPN (Common Anode)
	P	PNP (Common Cathode)

※ Color of modules can be changed at customer's request

※ L type bracket sold separately

Suffix code

Model	Code	Content
STL	<input type="checkbox"/> - <input type="checkbox"/> <input type="checkbox"/> <input type="checkbox"/> <input type="checkbox"/>	Sign tower (LED light source)
Diameter size	040	Ø40 cylinder type
	060	Ø60 cylinder type
	080	Ø80 cylinder type
Function	A	Continuous light only
	F	Continuous light, flashing light and buzzer (selected by the external signal)
Power voltage	C51	24 V a.c. / d.c. 50/60 Hz (dual usage)
	A11	100 - 240 V a.c. 50/60 Hz
Module colors	1	1 stack (red)
	2	2 stack (red, green)
	3	3 stack (red, yellow, green)
	4	4 stack (red, yellow green, blue)
	5	5 stack (red, yellow, green, blue, white)
Supporter selection	D	Direct installation (bolt fixing installation)
	L	L type bracket
	M	Plastic supporter (standard)
Optional		STM supporter
		Elbow type supporter installation (EPM)

※ Composition of stacking modules: Upper side (1st stack) to the lower side.

Supporter

Model	Direct installation	L Type bracket	M Type Plastic round supporter (standard)	STM supporter		EPM Elbow type supporter (option)
				STM-84 ※ for STL040, STL060	STM-105 ※ for STL060, STL080	
Appearance						

Signal Lights





■ HY-STE series (Ø60) Sign Towers

Specifications

Base unit specifications

Model	STE060-BAD51	STE060-BFD51	STE060-BAA11	STE060-BFA11	Dimension
Power voltage	24 V d.c.		100 - 240 V a.c. 50/60 Hz		 DC type AC type
Function	Lighting only	Lighting, Flickering, Buzzer (External signal)	Lighting only	Lighting, Flickering, Buzzer (External signal)	
Flickering time	-	60 times / minute	-	60 times / minute	
Buzzer sound types	-	A single melody / beeping	-	A single melody / beeping	
Size of buzzer sound	-	85 dB (1 m distance)	-	85 dB (1 m distance)	
Consumption of electrical power	-	1.2 W	-	1.2 W	
Ambient temperature & humidity	-5 °C ~ 50 °C, 35 ~ 85 % RH (without condensation)				
Weight	76 g	96 g	160 g	178 g	

LED unit specifications

Model	STE060-LR	STE060-LY	STE060-LG	STE060-LB	STE060-LW
Dimension					
Power voltage	24 V d.c.				
Consumption of electrical power	1.2 W				
Light source	LED				
Emission angle	360 °				
Ambient temperature & humidity	-5 °C ~ 50 °C, 35 ~ 85 % RH (without condensation)				
Weight (g)	43 g				

■ Suffix code

Model	Code	Content
STE060 -	<input type="checkbox"/> <input type="checkbox"/> <input type="checkbox"/> <input type="checkbox"/>	Ø60 LED Light Sign Tower
Function	A	Lighting only
	F	Lighting, Flickering, Buzzer (External signal)
Power voltage	D51	24 V d.c.
	A11	100 - 240 V a.c. 50- 60 Hz
Stacking modules	1	1 stack (red)
	2	2 stacks (red, Green)
	3	3 stacks (red, Yellow, Green)
	4	4 stacks (red, Yellow, Green, Blue)
	5	5 stacks (red, Yellow, Green, Blue, White)
Supporter selection	L	L type bracket (Standard type)
	E	Elbow type supporter (EPM-18)
	M	Plastic supporter (MP-60)
	S	Plastic supporter (ST-011)



※ The color was arranged from top to bottom in following order, red, Yellow, Green, Blue, and White. There are two types of functions which are lighting only / Lighting, Flickering & Buzzer.



■ Base unit suffix code

Model	Code	Content
STE060 -	<input type="checkbox"/> <input type="checkbox"/> <input type="checkbox"/>	STE060 Sign Tower Base Unit
Classification	B	Base unit
Function	A	Lighting only
	F	Lighting, Flickering, Buzzer (external signal)
Power voltage	D51	24 V d.c.
	A11	100 - 240 V a.c. 50/60 Hz

■ LED unit suffix code

Model	Code	Content
STE060 -	<input type="checkbox"/> <input type="checkbox"/>	STE060 Sign Tower LED Unit
Classification	L	LED unit
Unit	R	Red unit
	Y	Yellow unit
	G	Green unit
	B	Blue unit
	W	White unit

■ Supporter

Model	L Type bracket	EPM Elbow type supporter (option)	M Type Plastic round supporter (standard)	ST-011 supporter
Appearance				

■ STE025 series (Ø25) Modular LED Sign Towers

■ Specifications

Functions	Continuous light
Power voltage	24 V d.c.
Body material / color	ABS / chrome plated & ivory
Lens colors	Red, green, yellow
Diameter	Ø25
Max. number of stacks	3 stacks

■ Suffix code

Model	Code	Content
STE025 -	<input type="checkbox"/> <input type="checkbox"/>	Ø25 LED Modular Sign Tower
Power voltage	D51	24 V d.c.
Number of stacks	1	1 stack (red)
	2	2 stacks (red, green)
	3	3 stacks (red, yellow, green)
Lens colors	S	Body color: chrome plated
	N	Body color: ivory













※ L type bracket sold separately

Temperature Controllers
Recorders
Digital Counter/ Timers
Analog Timers
Multi Pulse Meters
Panel Meters
Peripheral Devices
Proximity Sensors
Photo Sensors
Rotary Encoders
Thyristor Power Regulators
Solid State Relays
Power Supplies
Control Switches, Combination Display Lights
Power / Main / Cam Switches
Limit Switches
Micro Switches
Foot / Mono Lever / Pendant Switches
Signal Lights
Power Buzzers / Terminal Blocks / Fuse Holders / Control Boxes





Signal Lights

■ HY-TN series (Ø55) Sign Towers

■ Specifications

Stage	Model	Voltage	Consumption power	Bulb	Stage	Model	Voltage	Consumption power	Bulb	Flashing
 1	HY-TN-24-1 HY-TN-220-1	24 V d.c. 220 V a.c.	0.21 A 0.04 A	5 W	 1	HY-TWBN-24-1 HY-TWBN-220-1	24 V d.c. 220 V a.c.	0.21 A 0.04 A	5 W	60 / minute
 2	HY-TN-24-2 HY-TN-220-2	24 V d.c. 220 V a.c.	0.42 A 0.08 A	5 W	 2	HY-TWBN-24-2 HY-TWBN-220-2	24 V d.c. 220 V a.c.	0.42 A 0.08 A	5 W	
 3	HY-TN-24-3 HY-TN-220-3	24 V d.c. 220 V a.c.	0.63 A 0.11 A	5 W	 3	HY-TWBN-24-3 HY-TWBN-220-3	24 V d.c. 220 V a.c.	0.63 A 0.11 A	5 W	
 4	HY-TN-24-4 HY-TN-220-4	24 V d.c. 220 V a.c.	0.84 A 0.14 A	5 W	 4	HY-TWBN-24-4 HY-TWBN-220-4	24 V d.c. 220 V a.c.	0.84 A 0.14 A	5 W	
 5	HY-TN-24-5 HY-TN-220-5	24 V d.c. 220 V a.c.	1.05 A 0.17 A	5 W	 5	HY-TWBN-24-5 HY-TWBN-220-5	24 V d.c. 220 V a.c.	1.05 A 0.17 A	5 W	

■ Suffix code

Model	Code	Content
HY-	<input type="checkbox"/> - <input type="checkbox"/> <input type="checkbox"/> - <input type="checkbox"/>	HY-TN Series Sign Tower
Function	TN	Continuous light only
	TWBN	Continuous light, flashing light, buzzer
Power voltage	24	24 V d.c.
	220	220 V a.c.
Stacking modules	1	1 stack (red)
	2	2 stack (red, green)
	3	3 stack (red, yellow, green)
	4	4 stack (red, yellow, green, blue)
	5	5 stack (red, yellow, green, blue, white)
Supporter selection		No indication (L type bracket standard)
Accessories		ST-011 (Plastic bracket installation)
		MP-60 (Plastic bracket installation (Bar type))
		EPM (Plastic elbow type bracket)

WME series Wall Mounted Lights

Specifications

Model	WME
Appearance	
Function	A : Continuous light, F : Continuous light, Flashing light, Buzzer
Body color	B : Beige C : Chrome plating
Rated voltage	24 V a.c. / d.c. (12 V: order-made)
Number of tiers	3 tiers
Power consumption	Max. 2.1 W
Buzzer	2 tones, Approx. 85 dB (1 m)
Operation	NPN, PNP transistor open collector drive 24 V a.c. / d.c.

Suffix code

Model	Code	Content
WME-	<input type="checkbox"/> <input type="checkbox"/> <input type="checkbox"/>	Wall Mounted Light
Appearance	B	Beige color body
	C	Chrome gold plating body
Function	A	Continuous light indication
	F	Continuous light indication, flashing light indication, buzzer (selected by the external signal)
Power voltage	C51	24 V a.c. / d.c. 50/60 Hz dual usage
	C41	12 V a.c. / d.c. 50/60 Hz dual usage ※ order-made

Temperature
Controllers

Recorders

Digital
Counter/
Timers

Analog
Timers

Multi Pulse
Meters

Panel
Meters

Peripheral
Devices

Proximity
Sensors

Photo
Sensors

Rotary
Encoders

Thyristor
Power
Regulators

Solid
State
Relays

Power
Supplies

Control Switches,
Combination
Display Lights

Power / Main /
Cam Switches

Limit
Switches

Micro
Switches

Foot /
Mono Lever /
Pendant Switches

Signal Lights

Power Buzzers /
Terminal Blocks
Fuse Holders /
Control Boxes

Signal Lights

■ WMS series Wall Mounted Lights

■ Specifications

Model	WMS
Appearance	
Function	A : Continuous light F : Continuous light, Flashing light, Buzzer
Body color	Red, Yellow, Green, Blue, White
Rated voltage	24 V a.c. / d.c. (12 V: order-made)
Number of tiers	1, 2, 3, 4, 5 tiers
Power consumption	0.5 W per each lamp, max. 3.2 W for 5 stacks F type
Buzzer	2 tones, 70 dB (1 m)
Operation	NPN, PNP transistor open collector drive 24 V a.c. / d.c.

■ Suffix code

Model	Code	Content
WMS-	<input type="checkbox"/> <input type="checkbox"/> <input type="checkbox"/>	Wall Mounted Light
Appearance	A	Only for continuous light
	F	Continuous light, flashing light, buzzer (selected by the external signal)
Function	C51	24 V a.c. / d.c. 50/60 Hz Dual usage (Standard specification)
	C41	12 V a.c. / d.c. 50/60 Hz Dual usage ※ order-made
Power voltage	1	1 stack (red)
	2	2 stack (red, Green)
	3	3 stack (red, Yellow, Green)
	4	4 stack (red, Yellow, Green, Blue)
	5	5 stack (red, Yellow, Green, Blue, White)

T series Revolving Warning Lights

Specifications

Model	T060/T084	T060/T084	T060/T084/T100/T150	T060/T084/T100	T060/T084/T100/T150	T060/T084/T100
Appearance						
Functions	Rotating continuous light				Rotating continuous light, buzzers	
Appearance	Round cap supporter installation	Square cap supporter installation	Square cap direct installation	Round cap direct installation	Square cap direct installation	Round cap direct installation
Power voltage	12 V d.c., 24 V d.c., 110 / 220V a.c., 50/60 Hz					
Current consumption	0.9 A (power voltage: 12 V d.c.), 0.5 A (power voltage: 24 V d.c.), 0.1 A (power voltage: 110 V a.c.), 0.05 A (power voltage: 220 V a.c.)					
Rotating cycle	Approx. 140 times/min					
Light source	● T060/T100: incandescent lamp (G18), ● T084: incandescent lamp (BA15S), ● T150: incandescent lamp (S25)					
Bulb capacity	T060	12 V 5 W (power voltage 12 V d.c.), 24 V 5 W (power voltage 24 V d.c.), 110 V 5 W (power voltage 110 V a.c.), 220 V 5 W (power voltage 220 V a.c.)				
	T084	12 V 5 W (power voltage 12 V d.c.), 24 V 5 W (power voltage 24 V d.c.), 12 V 5 W (power voltage 110/220 V a.c.)				
	T100	12 V 10 W (power voltage 12 V d.c.), 24 V 10 W (power voltage 24 V d.c.), 12 V 10 W (power voltage 110/220 V a.c.)				
	T150	12 V 15 W (power voltage 12V d.c.), 24 V 15 W (power voltage 24V d.c.), 24 V 15 W (power voltage 110/220 V a.c.)				
Buzzer volume	-				Approx. 80 dB	
Cap materials	Polycarbonate (PC) resin					
Body	ABS resin					
Cap colors	Red, yellow, green, blue					
Degree of protection	IP54 (IEC 60529)					

Suffix code

Model	Code						Content
T	<input type="checkbox"/>	<input type="checkbox"/>	<input type="checkbox"/>	<input type="checkbox"/>	<input type="checkbox"/>	<input type="checkbox"/>	Revolving Warning Light
Appearance	060						Ø60
	084						Ø84
	100						Ø100
	150						Ø150
Cap appearance	P						Round cap ※ except ø150 model
	F						Square cap
Functions	A						Rotating continuous light
	F						Rotating continuous light / Buzzer
Power voltage	D12						12 V d.c.
	D24						24 V d.c.
	A110						110 V a.c.
	A220						220 V a.c.
Cap colors	R						Red
	Y						Yellow
	G						Green
	A						Blue (only with Ø 84 model)
Installation	D						Direct installation type (basic type)
	M						Supporter installation type ※ only with Ø60/ Ø84 models with rotating continuous light

Signal Lights

RLA-KB/KBB Turn Lights

Specifications

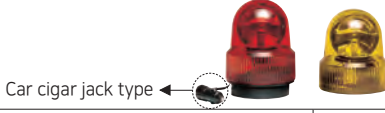
Model	RLA-KB□	RLA-KBB□□
Appearance		
Function	Rotating continuous light	Rotating continuous light, buzzer
Dimension	Ø118	
Power voltage	12 V d.c., 24 V d.c., 110 V a.c., 220 V a.c. 50/60 Hz	
Power consumption	0.9 A (power voltage: 12 V d.c.), 0.5 A (power voltage: 24 V d.c.), 0.1 A (power voltage: 110 V a.c.), 0.05 A (power voltage: 220 V a.c.)	
Rotating speed	Approx. 140 times/min	
Light source	Incandescent lamp (BA15S)	
Buzzer volume	-	Approx. 80 dB
Material	Cap: acryl resin, Body : ABS resin	
Cap color	Red, Yellow, Green	
Degree of protection	IP54 (IEC 60529)	

Suffix code

Model	Code	Content
RLA-	□ □ □ -□	Turn Light (Ø118)
Function	KB	Rotating continuous light
	KBB	Rotating continuous light and buzzer built-in
Power voltage	D12	12 V d.c.
	D24	24 V d.c.
	A110	110 V a.c.
	A220	220 V a.c.
Cap color	R	Red
	Y	Yellow
	G	Green
Installation method	D	Direct installation type
	M	Magnet supporter
	A	Car cigar jack and magnet supporter (12V d.c., 24 V d.c. available)

RLA-WX/WXB Signal Lights (Xenon lamp)

Specifications



Model	RLA-WX□□	RLA-WXB□□
Appearance		
Function	Strobe only	Strobe, Buzzer
Body type	Ø118 rectangular cap (Direct installation, Magnet attachment type supporter, Magnet attachment type supporter and cigar jack)	
Power voltage	12 V d.c., 24 V d.c., 110 V a.c., 220 V a.c. 50/60 Hz, Selected by the suffix code	
Power consumption	7.2 W (when Power voltage is 24 V d.c.), 12 W (when Power voltage is 220 V a.c.)	
Strobe speed	Approx. 60 times/min	
Light source	Xenon tube strobe light	
Buzzer	-	Buzzer built-in (approx. 90 dB from 1 m of distance)
Material	Cap: acryl resin, Body : ABS resin	
Cap color	Red, Blue, White	
Degree of protection	IP54 (IEC 60529)	

Suffix code

Model	Code	Content
RLA-	□ □ □	Signal Light (XENON Lamp)
Function	WX	Strobe light
	WXB	Strobe light and buzzer built-in type
Power voltage and installation method	01	12 V d.c.
	02	24 V d.c.
	10	110 V a.c.
	20	220 V a.c.
	10 m	110 V a.c.
	20M	220 V a.c.
	01A	12 V d.c.
	02A	24 V d.c.
Cap color	R	Red
	Y	Yellow
	B	Blue

LT series Signal Lights

Specifications

Appearance	Suffix code	Power voltage	Power consumption	Number of leds	Rotating cycle	Flickering
	LT-R-12	12 - 48 V d.c., 12 - 24 V a.c. 50/60 Hz	Max. 2.9 W (power voltage: 12 - 48 V d.c)	24	Approx. 90 times / min	Approx. 50 times / min
	LT-R-012	110/220 V a.c. 50/60 Hz	Max. 5 W	24		
	LT-P-12	12 - 48 V d.c., 12 - 24 V a.c. 50/60 Hz	Max. 2.9 W (power voltage: 12 - 48 V d.c)	24		
	LT-P-012	110/220 V a.c. 50/60 Hz	Max. 5 W	24		
	LT-PB-12	12 - 48 V d.c., 12 - 24 V a.c. 50/60 Hz	Max. 2.9 W (power voltage: 12 - 48 V d.c)	24		
	LT-PB-012	110/220 V a.c. 50/60 Hz	Max. 5 W	24		

Suffix code

Model	Code	Content
LT-	<input type="checkbox"/> <input type="checkbox"/> <input type="checkbox"/>	Signal Light (Ø84 Cap)
Installation type (Function)	R	Supporter mounting (rotating, flashing)
	P	Direct mounting (rotating, flashing)
	PB	Direct mounting (rotating, flashing, buzzer built-in)
		※ Optional supporter (STM-105)
Power voltage	12	12 - 48 V d.c., 12 - 24 V a.c. 50/60 Hz
	012	110/220 V a.c. 50/60 Hz
Cap color	R	Red
	Y	Yellow
	G	Green

SLB series Signal lights

Specifications

Model	SLB 060
Appearance	
Dimensions (cap size)	Ø70
Appearance	P: Round appearance lens, Direct mount (Buzzer), R: Round appearance lens, Prop mount F: Square appearance lens, Direct mount (Buzzer), X: Square appearance lens, Prop mount
Function	A: Continuous light F: Continuous light, Flashing light, Buzzer (by input signal)
Rated voltage	24 V a.c. / d.c., 110 - 240 V a.c. (12 V a.c. / d.c.: order-made) 50/60 Hz
Color	Red, Yellow, Green
Light	LED
Drive	NPN, PNP transistor open collector 24 V a.c./d.c.
Power consumption	Max. 2 W (24 V a.c. / d.c.), max. 3.5 W (110 - 240 V a.c.)
Buzzer	2 types of buzzer melodies (single melody, beeping), volume: 80 dB (1 m distance)





Suffix code

Model	Code	Content
SLB	<input type="checkbox"/> <input type="checkbox"/> <input type="checkbox"/> <input type="checkbox"/>	Turn Light
Dimension	060	Ø70 Cap
Design and function	RA	Round type cap supporter mounting installation
	XA	Rectangular type cap supporter mounting installation
	PA	Round type cap direct installation
	FA	Rectangular type cap direct installation
	PF	Round type cap direct installation
	FF	Rectangular type cap direct installation
Power voltage	C51	24 V a.c. / d.c. 50/60 Hz
	C41	12 V a.c. / d.c. 50/60 Hz ※ order-made
	A11	110 - 240 V a.c. 50/60 Hz
Cap color	R	Red
	Y	Yellow
	G	Green

Power Buzzers / Terminal Blocks / Fuse Holders / Control Boxes

■ HY-256/306/606/606N Power Buzzers

■ Specifications



Model	HY-256	HY-306	HY-606	HY-606N
Appearance				
Voltage	110 V a.c., 220 V a.c., 12 V d.c., 24 V d.c.			
Power consumption	4 VA : HY-256-1, HY-256-2, HY-306-1, HY-306-2 30 mA : HY-256-12, HY-256-24, HY-306-12, HY-306-24		8 VA : HY-606-1, HY-606N-1, HY-606-2, HY-606N-2 30 mA : HY-606-12, HY-606N-2, HY-606-24, HY-606N-24	
Cycle	50/60 Hz (for 110 V a.c. and 220 V a.c. models)			
Volume (distance 1 m)	85 dB * for HY-606-12, HY-606N-12, HY-606-24, HY-606N-24: 80 dB			
External diameter	For Ø25	For Ø30	Rectangular panel flush (for Ø66)	Rectangular panel extended (□80)

■ Suffix code

Model	Code	Content
HY-	<input type="checkbox"/> <input type="checkbox"/>	Power Buzzer
Dimension	256	For Ø25
	306	For Ø30
	606	Rectangular panel flush type (for Ø66)
	606N	Rectangular panel extended type (□80)
Voltage	1	110 V a.c., 50/60 Hz
	2	220 V a.c., 50/60 Hz
	12	12 V d.c.
	24	24 V d.c.

■ HY-606MD/MA 4-Tone Melody Buzzers

■ Specifications



Model	HY-606MD	HY-606MA
Appearance		
Voltage	12 / 24 V d.c.	110 / 220 V a.c.
Power consumption	2.5 W	
Frequency	-	
Volume (distance 1 m)	Max. 98 dB	
Diameter	Ø 66	

■ Suffix code

Model	Code	Content
HY-606	<input type="checkbox"/>	4-Tone Melody Buzzer
Dimension	MD	12 / 24 V d.c.
	MA	110 / 240 V a.c.

■ HY-226M/256M 3-Tone Electronic Buzzers

■ Specifications

Model	HY-226MD, MA	HY-256MD, MA
Appearance		
Voltage	100 - 240 V a.c. / 12 - 24 V d.c.	
Power consumption	0.6 W / 13.5 W	
Frequency	50/60 Hz	
Volume (distance 1 m)	80 dB	
Diameter	Ø 22/Ø 25	Ø 25







■ Suffix code

Model	Code	Content
HY-	<input type="checkbox"/> <input type="checkbox"/>	3-Tones Electronic Buzzer
Dimension	226	Ø22 / Ø25 dual usage (Front side: rectangular type)
	256	Ø25 (front side: round type)
Voltage	MD	12 - 24 V d.c.
	MA	100 - 240 V a.c.

Power Buzzers / Terminal Blocks / Fuse Holders / Control Boxes

■ HYBT, HYTM series Assembling Terminal Blocks

■ Specifications





Model	HYTM-15A	HYBT-15A2	HYTM-25A	HYTM-35A	HYTM-60A	HYTM-100A
Classification						
Rated Insulating voltage	600 V					
Rated current	15A	15A	25A	35A	60A	100A
Insulation resistance	Min. 100 MΩ (between each live part and between each live part and mounting metal plate)					
Dielectric strength	2500 V a.c. for 1 min (between live part and unfilled part)					
Terminal bolt	M3.5	M3.5	M4	M4	M6	M6
Ambient temperature & humidity	-20~55°C, 45-85% RH					

■ Accessories

■ Applying Accessory Classification

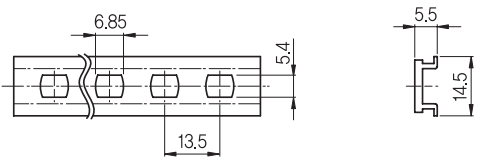
Model	HYTM-15A	HYBT-15A2	HYTM-25A	HYTM-35A	HYTM-60A	HYTM-100A
Rail	HYBT-01					
Separator	HYTM-02	HYBT-12	HYTM-02	HYTM-04	HYTM-05	HYTM-06
Stopper	HYBT-07					
Terminal number plate	HYTM-07	HYBT-10	HYTM-07			
Terminal number plate cover	HYTM-08	HYBT-08	HYTM-08			
Short terminal	HYBT-13	HYBT-13	-	-	-	-

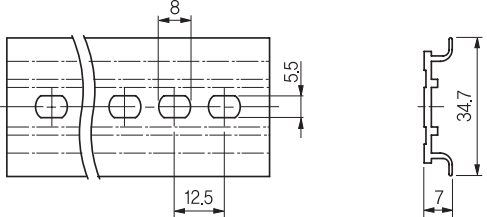
■ Aluminum Rail (DIN rail)

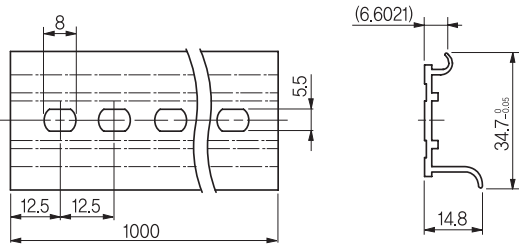
Appearance	Dimensions
 <p>HYBT-CH10 (10A)</p>	
 <p>HYBT-01 (15A ~ 100A)</p>	
 <p>HYBT-01A (15 A ~ 100 A slanted mount)</p>	

Power Buzzers / Terminal Blocks / Fuse Holders / Control Boxes

■ Separators



Model	Appearance	Dimensions
HYTM-02 (15A, 25A)		
HYTM-04 (35A)		
HYTM-05 (60A)		
HYTM-06 (100A)		

■ Separators

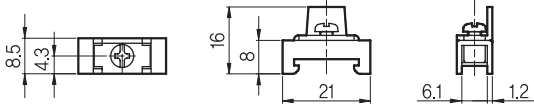

Model	Appearance	Dimensions
HYBT-12 (HYBT-15A2-A)		
HYBT-12 (HYBT-15A2-B)		

Power Buzzers / Terminal Blocks / Fuse Holders / Control Boxes

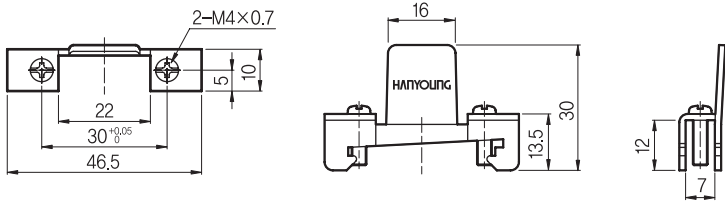

■ Stoppers

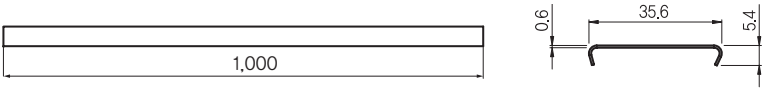
Model	Appearance	Dimensions
HYBT-ST10		
HYBT-07		

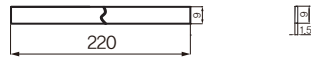

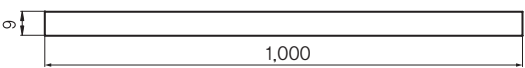

● Terminal number plate cover

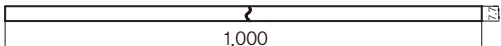
Model	Appearance	Dimensions
HYBT-08 ※ For HYBT-15A2		
HYTM-08		

■ Number plates (seals)

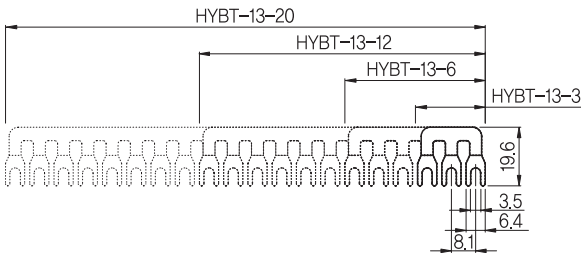
Model	Appearance	Dimensions
HYBT-10 (9 mm width) ※ For HYBT-15A2		
HYTM-07 (7.7 mm width)		

■ Short Bars

Appearance	Dimensions
 HYBT-13-3	
 HYBT-13-6	
 HYBT-13-12	
 HYBT-13-20	

※ Short bar HYBT-13-3~13-20 are only for the HYBT-15A

- Temperature Controllers
- Recorders
- Digital Counter/Timers
- Analog Timers
- Multi Pulse Meters
- Panel Meters
- Peripheral Devices
- Proximity Sensors
- Photo Sensors
- Rotary Encoders
- Thyristor Power Regulators
- Solid State Relays
- Power Supplies
- Control Switches / Combination Display Lights
- Power / Main / Cam Switches
- Limit Switches
- Micro Switches
- Foot / Mono Lever / Pendant Switches
- Signal Lights
- Power Buzzers / Terminal Blocks / Fuse Holders / Control Boxes

Power Buzzers / Terminal Blocks / Fuse Holders / Control Boxes

■ HYT series Fixing Type Terminal Blocks

● For rated current 10 A

Model	Appearance	Rating	Horizontal	Width	Height	Fixed dimensions
HYT-1010		10A 10P	112	24	17	102.5

● For rated current 20 A

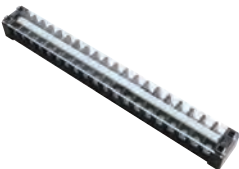
Model	Appearance	Rating	Horizontal	Width	Height	Fixed dimensions
HYT-203		20A 3P	56	30	20	44
HYT-204		20A 4P	68	30	20	56
HYT-206		20A 6P	89	30	20	78
HYT-2010		20A 10P	137	30	20	126
HYT-2012		20A 12P	163	30	20	150.5
HYT-2015		20A 15P	199	30	20	187
HYT-2020		20A 20P	257	30	20	245

● For rated current 30 A

Model	Appearance	Rating	Horizontal	Width	Height	Fixed dimensions
HYT-303		30A 3P	67	5	24	54.5
HYT-304		30A 4P	83	35	24	70
HYT-306		30A 6P	113	35	24	100.5
HYT-3010		30A 10P	153	35	24	143

● For rated current 60 A

Model	Appearance	Rating	Horizontal	Width	Height	Fixed dimensions
HYT-603		60A 3P	84.5	40	31	28
HYT-604		60A 4P	113.5	40	31	57

● For rated current 100 A

Model	Appearance	Rating	Horizontal	Width	Height	Fixed dimension
HYT-1003		100A 3P	104.5	55.5	36.5	35
HYT-1004		100A 4P	140	55.5	36.5	70

● For rated current 150 A

Model	Appearance	Rating	Horizontal	Width	Height	Fixed dimensions
HYT-1503		150A 3P	115.5	67.5	41	39
HYT-1504		150A 4P	153	67.5	41	77

Power Buzzers / Terminal Blocks / Fuse Holders / Control Boxes

● For rated current 200 A

Model	Appearance	Rating	Horizontal	Width	Height	Fixed dimensions
HYT-2003		200A 3P	134	72.5	44.5	45
HYT-2004		200A 4P	180	72.5	44.5	90

● For rated current 300 A

Model	Appearance	Rating	Horizontal	Width	Height	Fixed dimensions
HYT-3003		300A 3P	155.5	83.5	49.5	51.8
HYT-3004		300A 4P	207.5	83.5	49.5	103.6

● For rated current 400 A





Model	Appearance	Rating	Horizontal	Width	Height	Fixed dimensions
HYT-4003		400A 3P	155.5	83.5	49.5	51.8
HYT-4004		400A 4P	207.5	83.5	49.5	103.6

● For rated current 500 A

Model	Appearance	Rating	Horizontal	Width	Height	Fixed dimensions
HYT-5003		500A 3P	204	94	59.5	68
HYT-5004		500A 4P	270	93	59.5	136

■ HY-F15 series / HY-F30 series Fuse Holders

Specifications

Model	F15-1A	F15-1D	F15-2A	F15-2D	F15-3A	F15-3D	F30
Appearance							
Rated current	250 V a.c. 15 A	24 V d.c. 10 A	250 V a.c. 15 A	24 V d.c. 10 A	250 V a.c. 15 A	24 V d.c. 10 A	250 V a.c. 30 A
Remarks	AC 110 - 220 V a.c. DC 12 - 24 V d.c. ※ For Ø 6 X 30 mm ceramic fuses						110 - 600 V a.c. ※ For Ø 12 X 50 mm ceramic fuses

Power Buzzers / Terminal Blocks / Fuse Holders / Control Boxes

■ HY-25/30 series Rolled Iron Control Boxes

■ Specifications

Appearance	Model	Materials	Remarks
	HY-2501	Rolled iron	Ø25
	HY-2502		
	HY-2503		
	HY-2504		
	HY-2505		
	HY-2506		
	HY-3001	Rolled iron	Ø30
	HY-3002		
	HY-3003		
	HY-3004		
	HY-3005		
	HY-3006		

■ Suffix code

Model	Code	Content
HY-	<input type="checkbox"/> <input type="checkbox"/>	Rolled Iron Control Boxes
Installation hole	25	Ø25 installation hole
	30	Ø30 installation hole
Number of holes	01	1
	02	2 (03 : 3, 04 : 4, 05 : 5, 06 : 6)

■ HYC-M1/M2 series Cable Connectors

■ Specifications

Appearance	Model	Materials	Remarks
	HYC-M1	Polycarbonate (PC)	Ø8
	HYC-M2	Polycarbonate (PC)	Ø11

Always with our customers

www.hynux.com



nux
HANYOUNG



Control Switch

Control Instrument

Photo Sensor / Proximity Sensor

Thyristor Power Regulator

Sign tower / Signal light

World Leader in Control & Measurement

MAIN PRODUCTS

Temperature Controllers / Recorders / Digital Counters / Timers / Analog Timers / Panelmeters / Multi Pulse Meters
Sensors / Rotary Encoders / Thyristor Power Regulators / Solid State Relays / Power Supplies / Control Switches
Hoist Switches / Foot Switches / Mono Lever Switches / Micro Switches / Power Switches / Limit Switches /
Cam Switches / Main Switches / Sign Towers / Signal Lights / Buzzers / Terminal Blocks / Fuse Holders /
Control Boxes / Connector cables

HANYOUNG nux

ADDRESS : 28, Gilpa-ro 71beon-gil, Nam-gu, Incheon, 22121 Korea
T E L : +82-32-876-4697 FAX : +82-32-876-4696
E-mail : overseas@hynux.com

HANYOUNG NUX

MAIN PRODUCTS

Temperature controllers / Recorders / Counters / Timers / Panelmeters / Multi pulse meters / Proximity sensors / Photo sensors / Rotary encoders / Thyristor power regulators / Solid state relays / Power supplies / Control switches / Combination display lights / Power switches / Main switches / Cam switches / Limit switches / Micro switches / Hoist switches / Foot switches / Mono lever switches / Sign towers / Turn lights / Buzzers / Terminal blocks / Fuse holders / Control boxes / Connector cables

HANYOUNG NUX

HANYOUNG NUX CO.,LTD.

28, Gilpa-ro 71 beon-gil, Nam-gu, Incheon, Korea
Tel : +82-32-876-4697 Fax : +82-32-876-4696
E-mail : overseas@hynux.com

