

Temperature Controllers

E5CSV

CSM_E5CSV_DS_E_7_5

Easy Setting Using DIP Switch and Simple Functions in DIN 48 × 48 mm-size Temperature Controllers

- Easy setting using DIP switch.
- Models with two alarms added to Series, ideal for temperature alarm applications.
- Universal-input (thermocouple/platinum resistance thermometer) models also available.
- Clearly visible digital display with character height of 13.5 mm.
- Models available with black in addition to white cases.
- RoHS compliant.



For the most recent information on models that have been certified for safety standards, refer to your OMRON website.

 Refer to *Safety Precautions for All Temperature Controllers*.

Refer to *E5CS/E5CSV Operation* for operating procedures.

Model Number Structure

Model Number Legend

Models with Terminal Blocks

E5CSV-□□□□-□
1 2 3 4 5

1. Control Outputs

- R: Relay
- Q: Voltage for driving SSR

2. Alarm Outputs

- Blank: No alarm
- 1: 1 alarm
- 2: 2 alarms

3. Input

- KJ: Thermocouple
- P: Platinum resistance thermometer
- T: Thermocouple/platinum resistance thermometer (universal-input)

4. Power Supply Voltage

- Blank: 100 to 240 VAC
- D: 24 VAC/VDC

5. Case Color

- Blank: Black
- W: Light gray

Note: A functional explanation is provided here for illustration, but models are not necessarily available for all possible combinations. Refer to *Ordering Information* when ordering.

Examples

- Relay control output, without alarm, thermocouple/platinum-resistance thermometer multi input, black case : E5CSV-RT
- Relay control output, one alarm output, platinum resistance thermometer input, black case, light gray case : E5CSV-R1P-W

Ordering Information

■ List of Models

Case Color: Light Gray, Thermocouple or Platinum Resistance Thermometer, Power Supply Voltage: 100 to 240 VAC

| Size | Type | Control modes | Alarms | Outputs | Model with thermocouple | Model with platinum resistance thermometer |
|--------------------|----------------|---------------|--------|---------------------------|-------------------------|--|
| E5CSV 48 × 48mm | Terminal block | ON/OFF or PID | 1 | Relay | E5CSV-R1KJ-W | E5CSV-R1P-W |
| | | | | Voltage (for driving SSR) | E5CSV-Q1KJ-W | E5CSV-Q1P-W |

Case Color: Light Gray, Thermocouple, Power Supply Voltage: 24 VAC/VDC

| Size | Type | Control modes | Alarms | Outputs | Model with thermocouple |
|--------------------|----------------|---------------|--------|---------|-------------------------|
| E5CSV 48 × 48mm | Terminal block | ON/OFF or PID | 1 | Relay | E5CSV-R1KJD-W |

Case Color: Light Gray, Universal-input, Power Supply Voltage: 100 to 240 VAC

| Size | Type | Control modes | Alarms | Outputs | Model with universal-input (thermocouple or platinum resistance thermometer) |
|--------------------|----------------|---------------|---------------|---------------------------|--|
| E5CSV 48 × 48mm | Terminal block | ON/OFF or PID | 0 | Relay | E5CSV-RT |
| | | | | Voltage (for driving SSR) | E5CSV-QT |
| | | | 1 | Relay | E5CSV-R1T |
| | | | | Voltage (for driving SSR) | E5CSV-Q1T |
| | | | 2 (See note.) | Relay | E5CSV-R2T |
| | | | | Voltage (for driving SSR) | E5CSV-Q2T |

Note: There is no alarm output 2 mode switch. The default setting for alarm output 2 is for the upper limit alarm mode. To change the setting, change the alarm type for alarm output 2 in initial setting level 5. For details, refer to the "E5CSV/E5CS-U Digital Temperature Controller User's Manual" (Cat. No. H140-E1-01).

Case Color: Black, Universal-input, Power Supply Voltage: 24 VAC/VDC

| Size | Type | Control modes | Alarms | Outputs | Model with universal-input (thermocouple or platinum resistance thermometer) |
|--------------------|----------------|---------------|---------------|---------------------------|--|
| E5CSV 48 × 48mm | Terminal block | ON/OFF or PID | 0 | Relay | E5CSV-RTD |
| | | | | Voltage (for driving SSR) | E5CSV-QTD |
| | | | 1 | Relay | E5CSV-R1TD |
| | | | | Voltage (for driving SSR) | E5CSV-Q1TD |
| | | | 2 (See note.) | Relay | E5CSV-R2TD |
| | | | | Voltage (for driving SSR) | E5CSV-Q2TD |

Note: There is no alarm output 2 mode switch. The default setting for alarm output 2 is for the upper limit alarm mode. To change the setting, change the alarm type for alarm output 2 in initial setting level 5. For details, refer to the "E5CSV/E5CS-U Digital Temperature Controller User's Manual" (Cat. No. H140-E1-01).

■ Accessories (Order Separately)

Protective Cover

| Type | Model |
|-----------------------|----------|
| Hard Protective Cover | Y92A-48B |

Terminal Cover

| Model |
|-----------|
| E53-COV10 |

Terminal Cover

(For Controllers after the design change scheduled for October 2010)

| Model |
|-----------|
| E53-COV17 |

Note: The E53-COV10 Terminal Cover cannot be mounted to Controllers that are manufactured after the design change scheduled for October 2010

DIN Track Mounting Adapter

| Model |
|---------|
| Y92F-52 |

Rubber Packing

| Model |
|---------|
| Y92S-29 |

Note: The Rubber Packing is provided with the Digital Controller.

Specifications

■ Ratings

| | | |
|--------------------------------------|---|---|
| Supply voltage | | 100 to 240 VAC, 50/60 Hz 24 VAC, 50/60 Hz; 24 VDC |
| Operating voltage range | | 85% to 110% of rated supply voltage |
| Power consumption | | 100 to 240 VAC: 5 VA 24 VAC: 3 VA, 24 VDC: 2 W |
| Sensor input | | Thermocouple input type: K, J, L Platinum resistance thermometer input type: Pt100, JPt100 Universal-input (thermocouple/platinum resistance thermometer) type: K, J, L, T, U, N, R, Pt100, JPt100 |
| Control output | Relay output | SPST-NO, 250 VAC, 3A (resistive load) |
| | Voltage output (for driving the SSR) | 12 VDC, 21 mA (with short-circuit protection circuit) |
| Control method | | ON/OFF or 2-PID (with auto-tuning) |
| Alarm output | | SPST-NO, 250 VAC, 1A (resistive load) |
| Setting method | | Digital setting using front panel keys |
| Indication method | | 7-segment digital display (character height: 13.5 mm) and deviation indicators |
| Other functions | | <ul style="list-style-type: none"> • Setting change prohibit (key protection) • Input shift • Temperature unit change (°C/°F) • Direct/reverse operation • Temperature range, Sensor switching (K/J/L, Pt100/JPt100) • Switching is performed between a thermocouple and platinum resistance thermometer for universal-input models. • Control period switching • 8-mode alarm output • Sensor error detection |
| Ambient operating temperature | | -10 to 55°C (with no condensation or icing); with 3-year guarantee: -10 to 50°C |
| Ambient operating humidity | | 25% to 85% |
| Storage temperature | | -25 to 65°C (with no condensation or icing) |

- Note:** 1. Do not use an inverter output as the power supply. (Refer to *Safety Precautions for All Temperature Controllers*.)
2. Models for 24 VAC/DC can also be manufactured.

■ Characteristics

| | | |
|--|---|---|
| Setting accuracy | Thermocouple (See note 1.): (±0.5% of indication value or ±1°C, whichever is greater) ±1 digit max. Platinum resistance thermometer (See note 2.): (±0.5% of indication value or ±1°C, whichever is greater) ±1 digit max. | |
| Indication accuracy (ambient temperature of 23°C) | | |
| Influence of temperature | R thermocouple inputs: (±1% of PV or ±10°C, whichever is greater) ±1 digit max. Other thermocouple inputs: (±1% of PV or ±4°C, whichever is greater) ±1 digit max. | |
| Influence of voltage | Platinum resistance thermometer inputs: (±1% of PV or ±2°C, whichever is greater) ±1 digit max. | |
| Influence of EMS. (at EN61326-1) | | |
| Hysteresis (for ON/OFF control) | 0.2% FS (0.1% FS for universal-input (thermocouple/platinum resistance thermometer) models) | |
| Proportional band (P) | 1 to 999°C (automatic adjustment using auto-tuning/self-tuning) | |
| Integral time (I) | 1 to 1,999 s (automatic adjustment using auto-tuning/self-tuning) | |
| Derivative time (D) | 1 to 1,999 s (automatic adjustment using auto-tuning/self-tuning) | |
| Alarm output range | Absolute-value alarm: Same as the control range Other: 0 to input setting range full scale (°C or °F) Alarm hysteresis: 0.2°C or °F (fixed) | |
| Control period | 2/20 s | |
| Sampling period | 500 ms | |
| Insulation resistance | 20 MΩ min. (at 500 VDC) | |
| Dielectric strength | 2,000 VAC, 50/60 Hz for 1 min between current-carrying terminals of different polarity | |
| Vibration resistance | Malfunction | 10 to 55 Hz, 20 m/s ² for 10 min each in X, Y, and Z directions |
| | Destruction | 10 to 55 Hz, 0.75-mm single amplitude for 2 hr each in X, Y, and Z directions |
| Shock resistance | Malfunction | 100 m/s ² min., 3 times each in 6 directions |
| | Destruction | 300 m/s ² min., 3 times each in 6 directions |
| Life expectancy | Electrical | 100,000 operations min. (relay output models) |
| Weight | Approx. 120 g (Controller only) | |
| Degree of protection | Front panel: Equivalent to IP66; Rear case: IP20; Terminals: IP00 | |
| Memory protection | EEPROM (non-volatile memory) (number of writes: 1,000,000) | |
| EMC | EMI Radiated: | EN 55011 Group 1 Class A |
| | EMI Conducted: | EN 55011 Group 1 Class A |
| | ESD Immunity: | EN 61000-4-2: 4 kV contact discharge (level 2) 8 kV air discharge (level 3) |
| | Radiated Electromagnetic Field Immunity: | EN 61000-4-3: 10 V/m (80-1000 MHz, 1.4-2.0 GHz amplitude modulated) (level 3) 10 V/m (900 MHz pulse modulated) |
| | Conducted Disturbance Immunity: | EN 61000-4-6: 3 V (0.15 to 80 MHz) (level 2) |
| | Noise Immunity (First Transient Burst Noise): | EN 61000-4-4 |
| | Burst Immunity: | 2 kV power-line (level 3), 1 kV I/O signal-line (level 3) |
| Surge Immunity: | EN 61000-4-5: Power line: Normal mode 1 kV; Common mode 2 kV Output line (relay output): Normal mode 1 kV; Common mode 2 kV | |
| Voltage Dip/Interrupting Immunity: | EN 61000-4-11 0.5 cycle, 100% (rated voltage) | |
| Approved standards | UL 61010-1 (listing) CSA C22.2 No.1010-1 | |
| Conformed standards | EN61326-1 (See note 3.), EN61010-1, IEC61010-1 VDE 0106 Part 100 (finger protection), when the terminal cover is mounted. | |

- Note:** 1. The following exceptions apply to thermocouples.
 - U, L: ±2°C ±1 digit max.
 - R: ±3°C ±1 digit max. at 200°C or less
2. The following exceptions apply to platinum resistance thermometers.
Input set values 0, 1, 2, 3 for E5CSV: 0.5% FS ±1 digit max.
3. Industrial electromagnetic environment (EN/IEC 61326-1 Table 2)

Temperature Range

Thermocouple Input Models

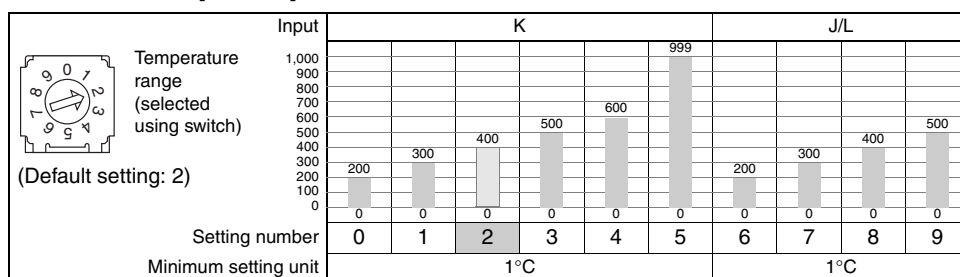

The shaded value indicates the default setting status.

Platinum Resistance Thermometer Input Models

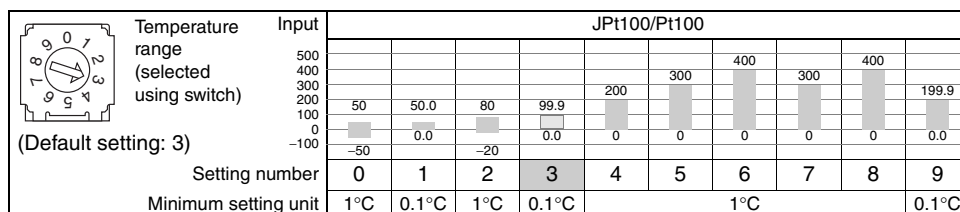

The shaded value indicates the default setting status.

Universal-input (Thermocouple/Platinum Resistance Thermometer) Models

Using Thermocouple Sensors, Control Mode Switch 5: OFF

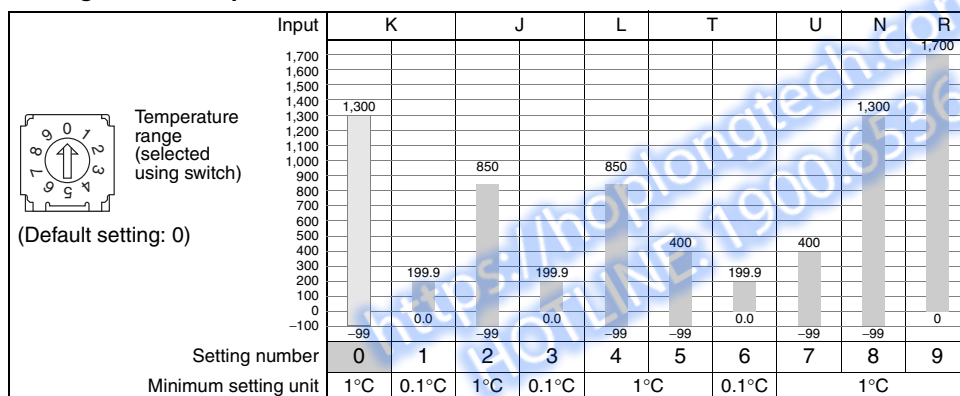

The shaded value indicates the default setting status.

Using Platinum Resistance Thermometers, Control Mode Switch 5: ON

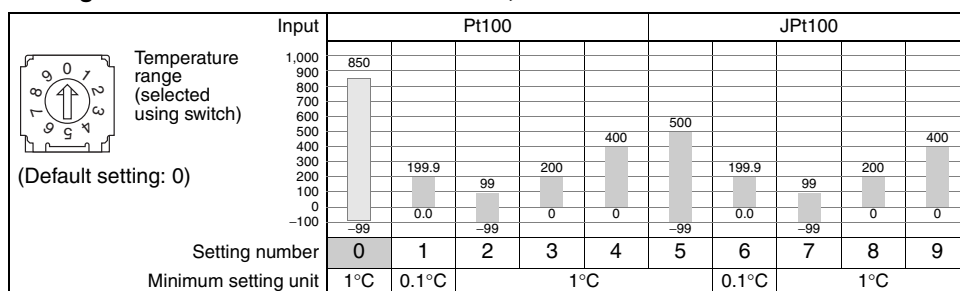

The shaded value indicates the default setting status.

External Connection Diagram

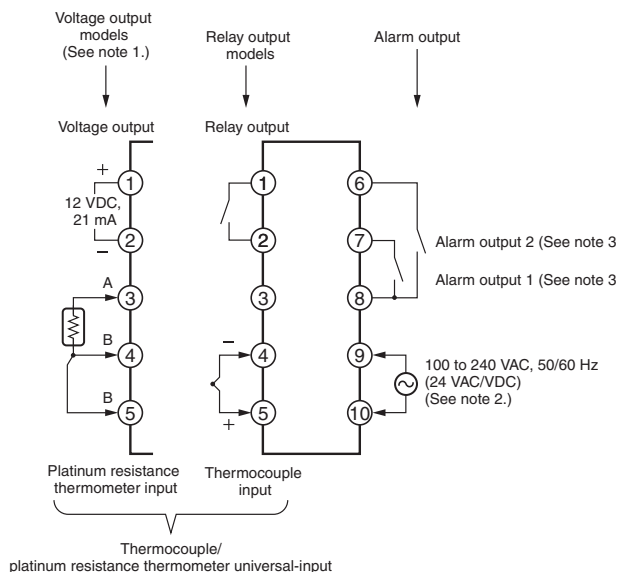

- Note: 1.** The voltage output (12 VDC, 21 mA) is not electrically isolated from the internal circuits. When using a grounding thermocouple, do not connect output terminals 1 or 2 to ground. Otherwise, unwanted current paths will cause measurement errors.
- 2.** Models with 100 to 240 VAC and 24 VAC/VDC are separate. Models using 24 VDC have no polarity.
- 3.** The number of alarm outputs depends on the model.

Nomenclature

E5CSV Models with Terminal Blocks



Dimensions

Note: All units are in millimeters unless otherwise indicated.

Controller

E5CSV

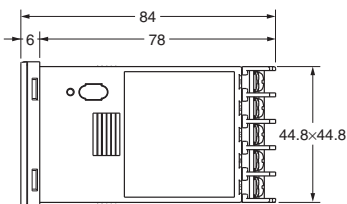
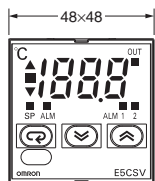

Panel Cutout Dimensions

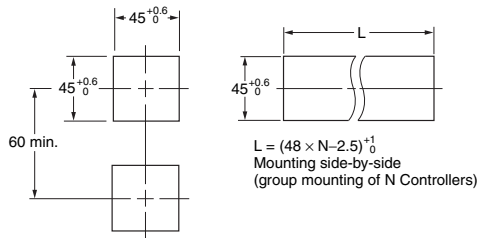

Note: Terminals cannot be removed.

E5CSV + Adapter for Flush Mounting (Provided)

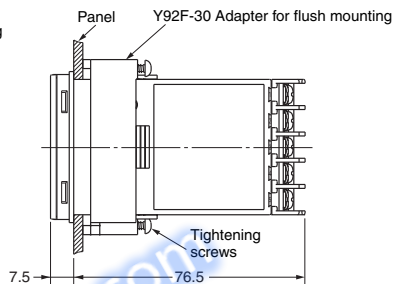
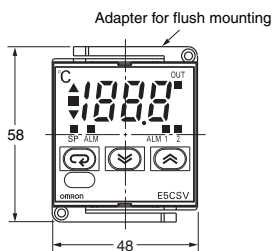
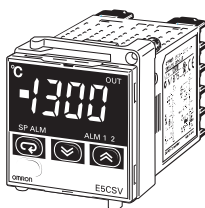
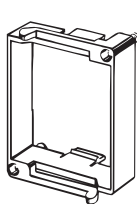

- Note: 1. The recommended panel thickness is 1 to 4 mm.
- 2. Group mounting is possible in one direction only.

DIN Track Mounting Adapter

Y92F-52 Note: This Adapter cannot be used together with the Terminal Cover. Remove the Terminal Cover to use the Adapter.

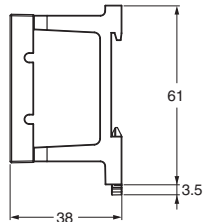
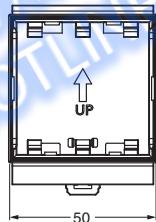
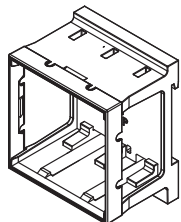

Mounted to E5CSV

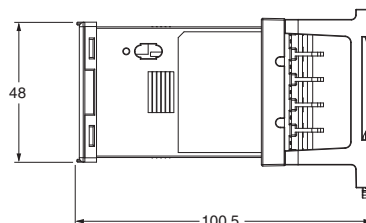
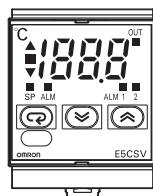

■ Accessories (Order Separately)

Hard Protective Cover

The Y92A-48B Protective Cover (hard type) is available for the following applications.

- To protect the set from dust and dirt.
- To prevent the panel from being accidentally touched causing displacement of set values.
- To provide effective protection against water droplets.

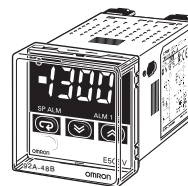

Terminal Cover

E53-COV10

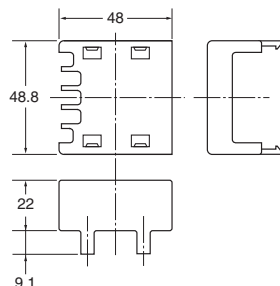
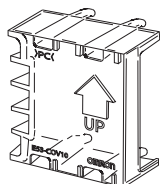

E53-COV17

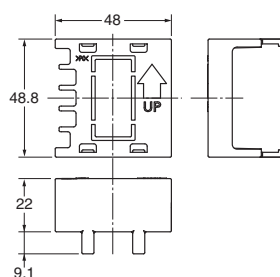
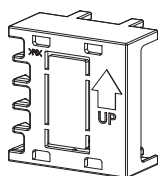

(For Controllers after the design change scheduled for October 2010)

Rubber Packing

Y92S-29 (for DIN48 × 48)

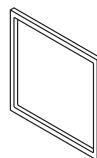

Order the Rubber Packing separately if it becomes lost or damaged. The Rubber Packing can be used to achieve an IP66 degree of protection for models with terminal blocks.

(Deterioration, shrinking, or hardening of the rubber packing may occur depending on the operating environment. Therefore, periodic replacement is recommended to ensure the level of waterproofing specified in NEMA4. The time for periodic replacement depends on the operating environment. Be sure to confirm this point at your site. Consider one year a rough standard. OMRON shall not be liable for the level of water resistance if the customer does not perform periodic replacement.)

The Rubber Packing does not need to be attached if a waterproof structure is not required.

Safety Precautions

Refer to *Safety Precautions for All Temperature Controllers*.

Refer to *E5CS/E5CSV Operation* for operating procedures.

ALL DIMENSIONS SHOWN ARE IN MILLIMETERS.

To convert millimeters into inches, multiply by 0.03937. To convert grams into ounces, multiply by 0.03527.

In the interest of product improvement, specifications are subject to change without notice.

Terms and Conditions Agreement

Read and understand this catalog.

Please read and understand this catalog before purchasing the products. Please consult your OMRON representative if you have any questions or comments.

Warranties.

(a) Exclusive Warranty. Omron's exclusive warranty is that the Products will be free from defects in materials and workmanship for a period of twelve months from the date of sale by Omron (or such other period expressed in writing by Omron). Omron disclaims all other warranties, express or implied.

(b) Limitations. OMRON MAKES NO WARRANTY OR REPRESENTATION, EXPRESS OR IMPLIED, ABOUT NON-INFRINGEMENT, MERCHANTABILITY OR FITNESS FOR A PARTICULAR PURPOSE OF THE PRODUCTS. BUYER ACKNOWLEDGES THAT IT ALONE HAS DETERMINED THAT THE PRODUCTS WILL SUITABLY MEET THE REQUIREMENTS OF THEIR INTENDED USE.

Omron further disclaims all warranties and responsibility of any type for claims or expenses based on infringement by the Products or otherwise of any intellectual property right. (c) Buyer Remedy. Omron's sole obligation hereunder shall be, at Omron's election, to (i) replace (in the form originally shipped with Buyer responsible for labor charges for removal or replacement thereof) the non-complying Product, (ii) repair the non-complying Product, or (iii) repay or credit Buyer an amount equal to the purchase price of the non-complying Product; provided that in no event shall Omron be responsible for warranty, repair, indemnity or any other claims or expenses regarding the Products unless Omron's analysis confirms that the Products were properly handled, stored, installed and maintained and not subject to contamination, abuse, misuse or inappropriate modification. Return of any Products by Buyer must be approved in writing by Omron before shipment. Omron Companies shall not be liable for the suitability or unsuitability or the results from the use of Products in combination with any electrical or electronic components, circuits, system assemblies or any other materials or substances or environments. Any advice, recommendations or information given orally or in writing, are not to be construed as an amendment or addition to the above warranty.

See <http://www.omron.com/global/> or contact your Omron representative for published information.

Limitation on Liability; Etc.

OMRON COMPANIES SHALL NOT BE LIABLE FOR SPECIAL, INDIRECT, INCIDENTAL, OR CONSEQUENTIAL DAMAGES, LOSS OF PROFITS OR PRODUCTION OR COMMERCIAL LOSS IN ANY WAY CONNECTED WITH THE PRODUCTS, WHETHER SUCH CLAIM IS BASED IN CONTRACT, WARRANTY, NEGLIGENCE OR STRICT LIABILITY.

Further, in no event shall liability of Omron Companies exceed the individual price of the Product on which liability is asserted.

Suitability of Use.

Omron Companies shall not be responsible for conformity with any standards, codes or regulations which apply to the combination of the Product in the Buyer's application or use of the Product. At Buyer's request, Omron will provide applicable third party certification documents identifying ratings and limitations of use which apply to the Product. This information by itself is not sufficient for a complete determination of the suitability of the Product in combination with the end product, machine, system, or other application or use. Buyer shall be solely responsible for determining appropriateness of the particular Product with respect to Buyer's application, product or system. Buyer shall take application responsibility in all cases.

NEVER USE THE PRODUCT FOR AN APPLICATION INVOLVING SERIOUS RISK TO LIFE OR PROPERTY OR IN LARGE QUANTITIES WITHOUT ENSURING THAT THE SYSTEM AS A WHOLE HAS BEEN DESIGNED TO ADDRESS THE RISKS, AND THAT THE OMRON PRODUCT(S) IS PROPERLY RATED AND INSTALLED FOR THE INTENDED USE WITHIN THE OVERALL EQUIPMENT OR SYSTEM.

Programmable Products.

Omron Companies shall not be responsible for the user's programming of a programmable Product, or any consequence thereof.

Performance Data.

Data presented in Omron Company websites, catalogs and other materials is provided as a guide for the user in determining suitability and does not constitute a warranty. It may represent the result of Omron's test conditions, and the user must correlate it to actual application requirements. Actual performance is subject to the Omron's Warranty and Limitations of Liability.

Change in Specifications.

Product specifications and accessories may be changed at any time based on improvements and other reasons. It is our practice to change part numbers when published ratings or features are changed, or when significant construction changes are made. However, some specifications of the Product may be changed without any notice. When in doubt, special part numbers may be assigned to fix or establish key specifications for your application. Please consult with your Omron's representative at any time to confirm actual specifications of purchased Product.

Errors and Omissions.

Information presented by Omron Companies has been checked and is believed to be accurate; however, no responsibility is assumed for clerical, typographical or proofreading errors or omissions.

2015.8

In the interest of product improvement, specifications are subject to change without notice.

OMRON Corporation
Industrial Automation Company

<http://www.ia.omron.com/>

(c)Copyright OMRON Corporation 2015 All Right Reserved.