

MELSERVO J2

SIMPLIFIED OPERATION WITH ADVANCED CAPABILITIES



A New Vision of the Future

The long-awaited MELSERVO-J2: Embodying an ever more exacting pursuit of higher performance and ease of use

The culmination of Mitsubishi servo technology is realized in the new J2 general-purpose AC servo. In addition to being a global product that satisfies EN, UL, and other global industrial standards, the J2's wide range of applications elevates the AC servo playing field to a new plane. The J2 is suited for use in high-power-rate, ultra-low-inertia, high-frequency applications and comes with an absolute encoder as standard equipment. It is IP65 compatible and fully equipped with the latest advanced features, including Mitsubishi's unique servo lock anti-microvibration function, real-time auto-tuning, and automatic motor recognition. With its enhanced features and ease of use, the J2 was well worth waiting for — Pointing the way toward a new vision of the future.

*Due for UL, cUL certification.



Contents

Main Features	3	Setup and Parameters	31	Safety Features	47
An Array of Handy Functions	5	Servo-amp Specifications	32	Peripheral Equipment	49
Servomotor Features and Amplifier Models	7	Signal Terminal Descriptions	33	Features	50
Applications and Motor Models	8	Amplifier Dimensions	35	Servo-amp Specifications	51
Model Configurations	9	Standard Wiring Diagram	36	Standard Wiring Diagram	52
Specifications and Characteristics	11	Interfaces	40	Options	53
Motor Dimensions	17	Safety Features	41	Options and Peripheral Equipment	55
Special Specifications	25	Peripheral Equipment	43	Command Unit	57
Peripheral Equipment	27	Setting and Two-Segment Display	44	Command Unit	58
Operation	28	Specifications and Display Messages	45	Using Personal Computers	59
Setup and Testing	29	Standard Wiring Diagram and Terminal Descriptions	46	Cautions Concerning Use	61
				Example of Selection	62



Main Features

Enhanced safety and ability to withstand environmental hazards

■ Satisfies overseas industrial standards

- The units in this series can be used in confidence knowing they are in conformity with overseas industrial standards.
- An EMC filter (optional) is available for meeting EN-standard EMC directives. The servo-amps meet low-voltage directives (LVD) in their standard configuration, as do the HC-SF and HC-RF servomotors. HC-MF and HA-FF servomotors that conform to the LVD are also available.
- UL, cUL standards:
Under the UL-CSA agreement, products certified under cUL standards are considered equivalent to products certified under CSA standards.
The servo-amps meet these standards in their standard configuration, and servomotors that do so are also available.

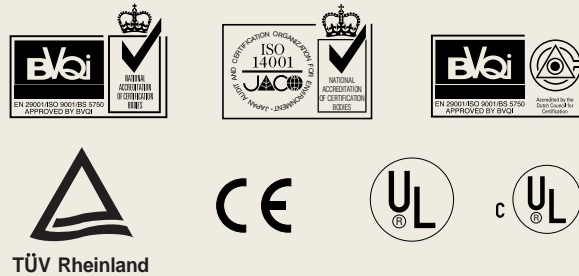

■ IP65 is standard equipment (HC-SF, HC-RF and HC-UF series)

- The HC-SF, HC-RF and HC-UF series of servomotors come with IP65 as standard equipment, enhancing their ability to withstand any environment.



Loaded with flexible functions

■ Absolute encoder is standard equipment

- Inclusion of an absolute encoder as standard equipment eliminates the need for a homing sequence, approximate DOG and other sensors, helping to reduce time and enhance reliability. In addition, users can switch easily from incremental to absolute positioning.
- With Mitsubishi's original absolute mode, an absolute system can be configured using conventional I/O even with pulse-train output control.

Once the amp's power has been turned on, servo amplifier causes absolute data to be sent to the motion controller at Servo ON.

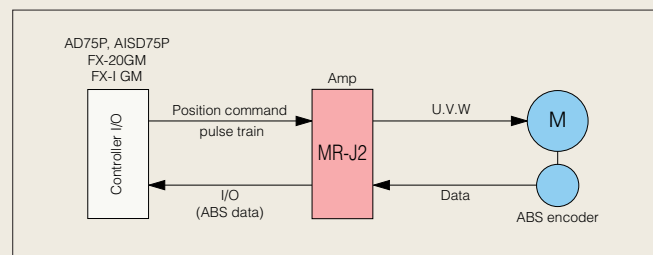

■ Achievement of an ultra-compact design

- Through a molding process that uses newly developed high thermal conductivity resins, the HC-MF series of servomotors achieves enhanced motor cooling performance and an ultra-compact design.
This makes it well suited to ultra-low-inertia, high-frequency applications.



Handy control functions

■ Separate wiring for the control power supply

- Wiring of the control power supply is separate from that for the main circuit power supply. When an alarm is triggered, the main circuit power supply can be turned off and the control power supply left on, making it possible to confirm the alarm message and operate the unit with confidence. This also makes it easier to handle EN-standard mechanical directives.

■ Torque control function

- The J2 comes equipped with a torque control function. In addition, users can switch between control modes: position/speed and speed/torque.

■ Stop-state anti-vibration function

- Microvibrations in the servo-lock state are suppressed through a unique method developed by Mitsubishi, making possible the construction of stable systems.

■ Real-time auto-tuning and high responsiveness

- With real-time auto-tuning, the unit is automatically adjusted to the optimal setting without any need for the gain adjustment unique to servomotors.

The sensitivity of the real-time auto-tuning can be changed in accordance with machine rigidity, enabling the J2 to accommodate an even wider range of machinery. (Response setting selection)

- Model adaptive control makes possible the realization of a highly responsive and stable system.

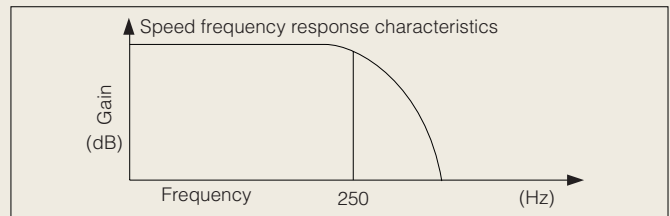

User-friendly features

■ Personal computer interface is standard equipment

- The J2 comes with RS-232C serial communications as a standard feature, enabling users to connect a personal computer to the J2.
- Using the setup software provided, users can display a variety of monitoring data, perform batch entry and saving of parameters, use graph functions, and perform test operation.

Model: MRZJW3-SETUP51E and above.

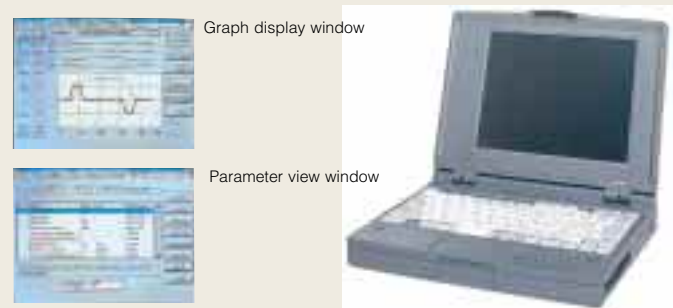

■ Automatic motor recognition feature

- Incorporating motor identification information into the encoder means that the servo-amp can automatically recognize the drive motor. When the servo-amp detects a mismatch, an alarm is triggered, eliminating the possibility of error and the need for setting parameters.

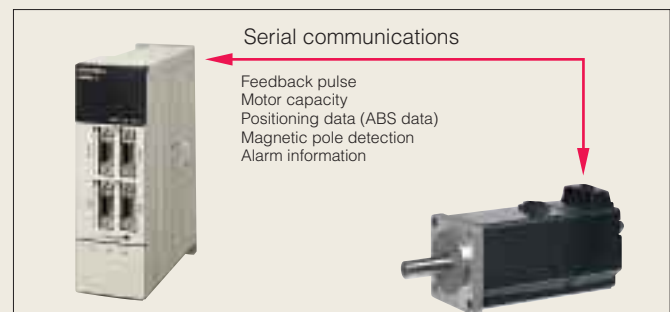

An Array of Handy Functions

Satisfies global industrial standards

The J2 can be used with the confidence of knowing it satisfies global industrial standards, including EN and UL.

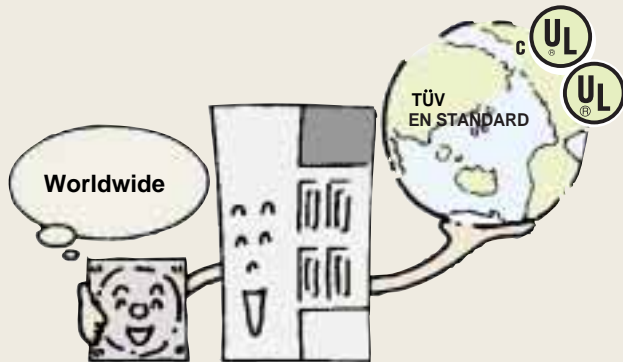

Absolute encoder is standard equipment

The J2 can be easily switched to absolute encoding, which requires no return to home, by merely adding a battery to the servo-amp and without changing the servomotor.

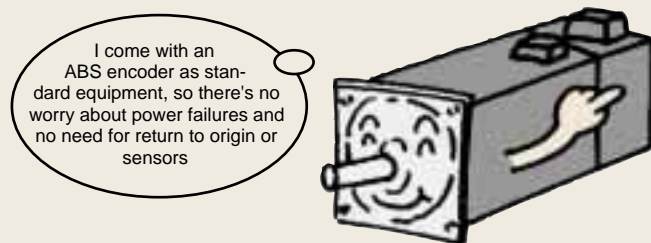

More compact servomotors

Mitsubishi's servomotors keep getting smaller: The ultra-compact HC-MF series, the low inertia HC-RF series, the medium inertia HC-SF series and flat type HC-UF series.

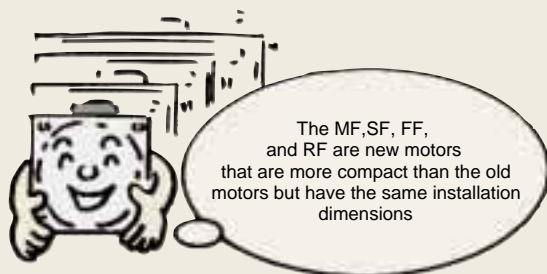

Enhanced ability to withstand environmental hazards

HC-SF, HC-RF and HC-UF series are rated IP65 as standard equipment.



Model adaptive control

Because the J2 operates in quick response to commands, it offers highly responsive and stable operation, unaffected by machine systems.

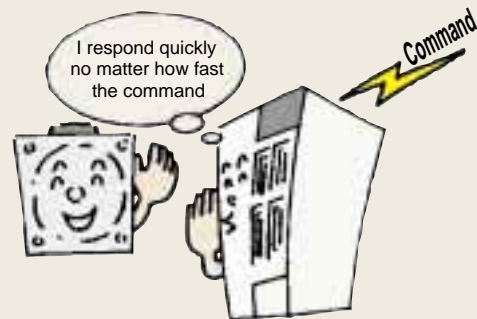

Servo-lock anti-microvibration function

Microvibrations in the servo-lock state are suppressed, making possible the construction of stable systems.

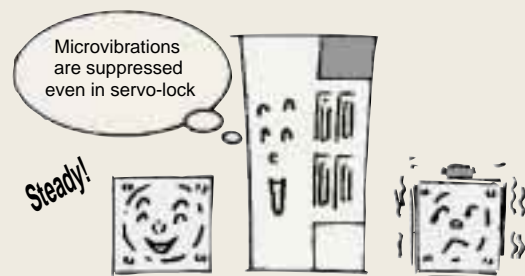

Personal computer interface is standard equipment

The J2 comes with an RS-232C serial communications connector as standard equipment, enabling users to connect a personal computer to the J2 to perform setup and to enter parameters. Special setup software is available.

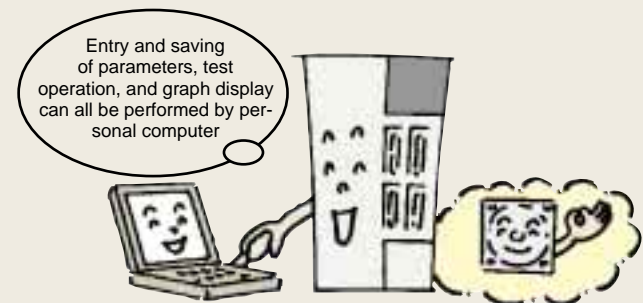

Automatic servomotor recognition

Once the encoder cable has been connected, the servo-amp can determine, as soon as its power is turned on, which servomotor is connected.

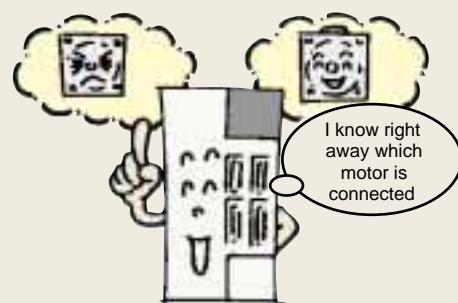

An Array of Handy Functions

Encoder serial communications

The encoder uses serial communications, so there are fewer signal wires to connect.

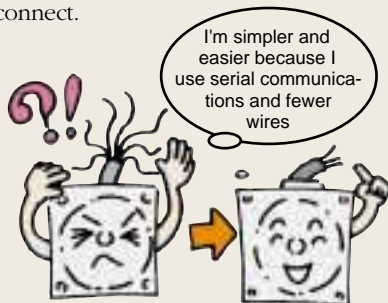

Real-time auto-tuning

The servo makes automatic gain adjustments even when the load's inertia changes.

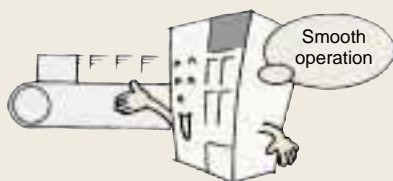

Separate wiring for the control power supply

The servo-amp's control power supply is wired separately, making it possible to turn off the main circuit only, when an alarm is triggered. This also makes it easier to handle EN-standard mechanical directives.

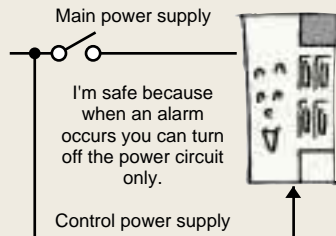

Built-in dynamic brake

With a built-in dynamic brake, the servomotor can be stopped immediately in a power failure or when an alarm has been triggered.

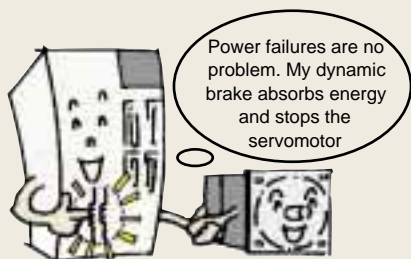

A wide variety of motors, including models with brakes

A broad lineup of servomotors including with brakes. Users can choose the motor series that best suits the machine being used.

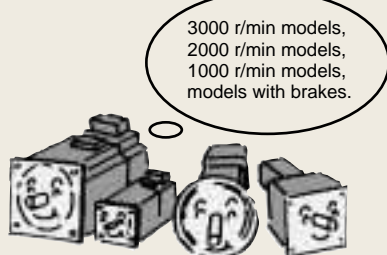

Built-in regenerative resistor

Regenerative resistor is built in, eliminating the need for an external regeneration unit during normal operation.

Switch between torque control mode and other control modes

Switching between torque, speed, and position control modes is possible for the first time.

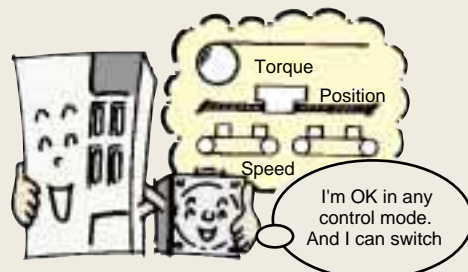

Control signal assignment feature (A, C type)

Control signals necessary for operation can be freely assigned to connector pins within a predetermined range, enabling more flexible operation.

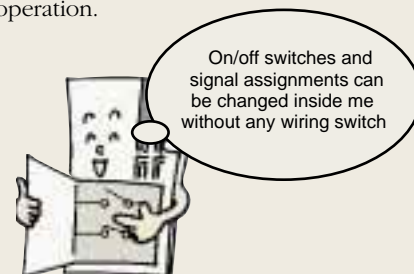

Command pulse train types (A type)

The J2 can handle three command types: encoder signals, pulse and direction, and CW/CCW pulse train.

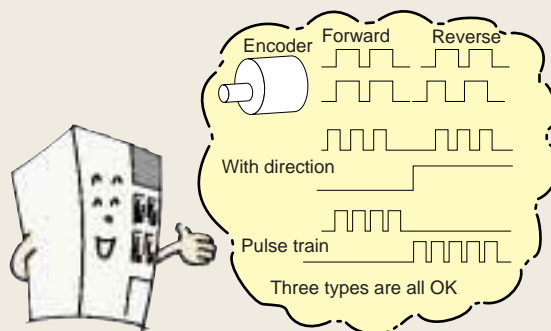

SSC-NET compatible (B type)

The controller is connected to each servo-amp through a high-speed serial bus, enabling users to issue commands to, and confirm the status of, the servo-amps with the motion controller. And fewer wires reduce the chances of a wiring error.



Servomotor Features and Amplifier Models

Motor series	Rated speed (maximum) (r/min)	Rated output capacity (kW)	Servo motor model	Servomotor type			Amp pairing MR-J2										
				With electro-magnetic brake (B)	With absolute encoder	Protective structure	10A 10B 10C	20A 20B 20C	40A 40B 40C	60A 60B 60C	70A 70B 70C	100A 100B 100C	200A 200B 200C	350A 350B 350C			
HC-MF series M 	3000 (4500)	0.05	HC-MF053	○	○	IP44	○										
		0.1	HC-MF13	○	○	IP44	○										
		0.2	HC-MF23	○	○	IP44		○									
		0.4	HC-MF43	○	○	IP44			○								
		0.75	HC-MF73	○	○	IP44				○							
HA-FF series F 	3000 (4000)	0.05	HA-FF053	○	○	IP44	○										
		0.1	HA-FF13	○	○	IP44	○										
		0.2	HA-FF23	○	○	IP44		○									
		0.3	HA-FF33	○	○	IP44			○								
		0.4	HA-FF43	○	○	IP44			○								
		0.6	HA-FF63	○	○	IP44				○							
HC-SF series S 	1000 (1500: 0.85kW / 1200: 1.2~3kW)	4-type 0.85, 1.2, 2.0, 3.0	HC-SF 81/121/201/301	○	○	IP65 (IP67)						○	○	○			
	2000 (3000: 0.5~1.5kW / 2500: 2~3.5kW)	5-type 0.5, 1.0, 1.5, 2.0, 3.5	HC-SF 52/102/152/202/352	○	○	IP65 (IP67)				○		○	○	○			
	3000 (3000)	5-type 0.5, 1.0, 1.5, 2.0, 3.5	HC-SF 53/103/153/203/353	○	○	IP65 (IP67)				○		○	○	○			
HC-RF series R 	3000 (4500)	1.0	HC-RF103	○	○	IP65									○		
		1.5	HC-RF153	○	○	IP65									○		
		2.0	HC-RF203	○	○	IP65											○
HC-UF series U 	2000 (3000)	3-type 0.75, 1.5, 2.0	HC-UF 72/152/202	○	○	IP65						○		○	○		
	3000 (4500)	4-type 0.1, 0.2, 0.4, 0.75	HC-UF 13/23/43/73	○	○	IP65 except connector (note 1)	○	○	○			○					

Note: Models within the production range and servo-amp compatible models.

Applications and Motor Models

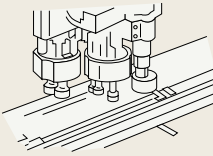
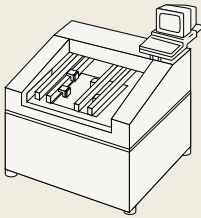
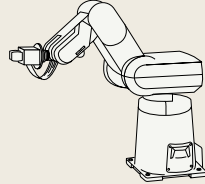
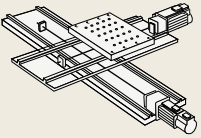
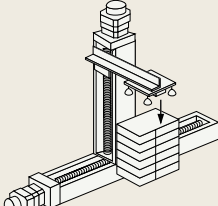
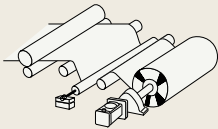
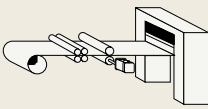
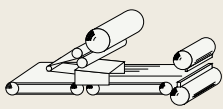
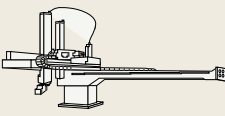
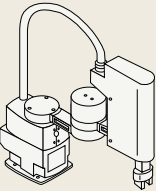
Feature	Application examples
<ul style="list-style-type: none"> • Ultra-low inertia, low capacity Interchangeable with existing model (HA-ME). Ultra-low inertia design makes this unit well suited for high-frequency positioning applications. Higher resolution positioning feedback pulse (8192 P/rev). • Enhanced power rate Power rate is 1.2 times that of existing models. 	<ul style="list-style-type: none"> • Inserters, mounters, bonders • Printed board hole openers • In-circuit testers • Label printers • Knitting and embroidery machinery • Ultra-small robots and robot tips <div style="display: flex; justify-content: space-around; align-items: center;">   </div> <div style="display: flex; justify-content: space-around; align-items: center;"> Inserters, mounters, bonders In-circuit testers </div>
<ul style="list-style-type: none"> • Low inertia, low capacity Interchangeable with existing model (HA-FE). Higher resolution positioning feedback pulse (8192 P/rev). Stable control can be performed from low to high speeds, enabling this unit to handle a wide range of applications. 	<ul style="list-style-type: none"> • LCD and conveyors • Food preparation machinery • Printers • Small loaders and unloaders • Small robots and component assembly devices • Small X-Y tables • Small press feeders <div style="display: flex; justify-content: space-around; align-items: center;">   </div> <div style="display: flex; justify-content: space-around; align-items: center;"> Small robots Small X-Y table devices </div>
<ul style="list-style-type: none"> • Medium inertia, medium capacity Interchangeable with existing model (HA-SE). Higher resolution positioning feedback pulse (16384 P/rev). Stable control can be performed from low to high speeds, enabling this unit to handle a wide range of applications. • Enhanced power rate Power rate is 1.5 times that of existing models. • IP65 Designed to withstand environmental hazards. 	<ul style="list-style-type: none"> • Conveyor machinery • Specialized machinery • Robots • Loaders and unloaders • Winders and tension devices • Turrets • X-Y tables • Test devices <div style="display: flex; justify-content: space-around; align-items: center;">   </div> <div style="display: flex; justify-content: space-around; align-items: center;"> Conveyor machinery Winders and tension devices </div>
<ul style="list-style-type: none"> • Low inertia, medium capacity Low inertia design makes this unit well suited to high-frequency positioning applications. Higher resolution positioning feedback pulse (16384 P/rev). • High power rate Power rate is approximately 3 times that of HA-LH. • IP65 Designed to withstand environmental hazards. 	<ul style="list-style-type: none"> • Roll feeders • Loaders and unloaders • High-frequency conveyor machinery <div style="display: flex; justify-content: space-around; align-items: center;">   </div> <div style="display: flex; justify-content: space-around; align-items: center;"> Roll feeders Wrapping machinery </div>
<ul style="list-style-type: none"> • Flat low capacity, medium capacity Enable stable control from low speeds to high, making them suitable for a wide range of applications. Flat design produces slimmer machine profiles. Resolution is higher for the positioning feedback pulse (low capacity: 8192 P/rev; Medium capacity: 16384 P/rev). • IP65 Environmentally sensitive design. 	<ul style="list-style-type: none"> • Robots • Conveyor machines • Food processing machines • Winder and tension devices <div style="display: flex; justify-content: space-around; align-items: center;">   </div> <div style="display: flex; justify-content: space-around; align-items: center;"> AC robot Micro robot </div>

Model Configurations

■ Servo-amp

MR-J2-10 A 1

Mitsubishi
servo-amp
series name

A: Standard
B: SSC-NET
C: With built-in positioning function

Symbol	Power supply
None	3-phase AC 200V or single-phase AC 100V
1	Single-phase AC 100V

Compatible motor output capacity (kW)

Symbol	HC-MF	HA-FF	HC-SF			HC-RF	HC-UF	
			1000 r/min	2000 r/min	3000 r/min		2000 r/min	3000 r/min
10	053, 13	053, 13	—	—	—	—	—	13
20	23	23	—	—	—	—	—	23
40	43	33, 43	—	—	—	—	—	43
60	—	63	—	52	53	—	—	—
70	73	—	—	—	—	—	72	73
100	—	—	81	102	103	—	—	—
200	—	—	121, 201	152, 202	153, 203	103, 153	152	—
350	—	—	301	352	353	203	202	—

■ Servomotor

HC-MF 05 3 - B -

Mitsubishi AC servomotors
HC-MF series
HA-FF series
HC-SF series
HC-RF series
HC-UF series

Symbol	Electromagnetic brake
None	—
B	Installed

Symbol	Axial end
None	Standard*1
K	Key way*3
D	D-cut*2

Symbol	Rated output capacity (kW)
05	0.05
1 to 7	0.1 to 0.75
10 to 35	1.0 to 3.5

(HC-MF and -UF3000 r/min series)

Symbol	Input supply format
None	Lead
C	—

(HC-SF, -RF, and -UF2000 r/min series)

Symbol	Input supply format
None	Canon connector
C	—

(HA-FF series)

Symbol	Input supply format	
	HA-FF	HA-FF-UE
None	Lead	—
C	—	Canon connector

Symbol	Rated (r/min)
1	1000
2	2000
3	3000

Note: Make a specific enquiry regarding whether specially developed products meet standards.

Notes:

1. A key way is standard on the HA-FF23 through HA-FF63. All others have a straight shaft as standard.
2. The D-cut works only with the HC-MF and HA-FF models of 100W or less.
3. HC-MF□K and HC-UF□K (3000 r/min) have key.

(HC-MF, HA-FF series)

Symbol	Non-Japanese standard compatibility
None	Standard product. Japanese compatibility
UE	Meet EN and UL/cUL standard

Note: The standard specifications of the HC-SF, HC-RF, and HC-UF model series meet EN and UL/cUL standards.

SERVO MOTORS HA/HC -MF/FF/SF/RF/UF

Servomotors
High torque
in Super-Compact
Dimensions

- Satisfies global industrial standards
 - IP65 is standard equipment (SF, RF and UF motors)
- Absolute encoder is standard equipment
 - Ultra-compact design



Specifications and Characteristics

HC-MF series servomotor specifications

Servomotor series		HC-MF series (low capacity, ultra-low inertia)					
Specifications	Models	MF053 (B)	MF13 (B)	MF23 (B)	MF43 (B)	MF73 (B)	
	Servomotor model HC-	MR-J2-10A/A1/B/C		MR-J2-20A/A1/B/C	MR-J2-40A/A1/B/C	MR-J2-70A/B/C	
Servomotor	Power facility capacity (kVA) (note 1)	0.3	0.3	0.5	0.9	1.3	
	Continuous characteristics	Rated output (W)	50	100	200	400	750
		Rated torque (N·m [oz·in])	0.16 (22.7)	0.32 (45.3)	0.64 (90.6)	1.3 (184.1)	2.4 (339.8)
	Maximum torque (N·m [oz·in])	0.48 (68.0)	0.95 (134.5)	1.9 (269.0)	3.8 (538.1)	7.2 (1019.5)	
	Rated rotation speed (r/min)	3000					
	Maximum rotation speed (r/min)	4500					
	Permissible instantaneous rotation speed (r/min)	5175					
	Power rate (kW/s)	13.47	34.13	46.02	116.55	94.43	
	Rated current (A)	0.85	0.85	1.5	2.8	5.1	
	Maximum current (A)	2.6	2.6	5.0	9.0	18	
	Regeneration braking frequency (times/min) (note 2)	With no options	(note 3)	(note 3)	(note 3)	1010	400
		MR-RB032 (30W)	-	-	-	3000	600
		MR-RB12 (100W)	-	-	-	(note 3)	2400
	Moment of inertia (figures inside parentheses indicate units with B)	J ($\times 10^{-4}$ kg·m ²)	0.019 (0.022)	0.03 (0.032)	0.088 (0.136)	0.143 (0.191)	0.6 (0.725)
		J (oz·in ²)	0.104 (0.120)	0.164 (0.175)	0.481 (0.744)	0.782 (1.05)	3.28 (3.97)
Recommended load/motor inertia ratio	30 times the servomotor's moment of inertia max. (note 4)						
Speed/position detector	Resolution per encoder/servomotor rotation: 8192 P/rev (Can handle up to 32768 P/rev with special specifications. The amp is made to order.)						
Attachments	Encoder						
Structure	Totally Enclosed non ventilated (protection degree: IP44) (note 6)						
Environment	Ambient temperature	0 to 40°C (32 to 104°F) (non freezing), storage: -15 to 70°C (5 to 158°F) (non freezing)					
	Ambient humidity	80% RH max. (non condensing), storage: 90% RH max. (non condensing)					
	Atmosphere	Indoors (no direct sunlight); no corrosive gas, inflammable gas, oil mist, or dust					
	Elevation/vibration (note 5)	1000 meters or less above sea level; X: 19.6 m/s ² (2 G), Y: 19.6 m/s ² (2 G)					
Weight	kg (lb)	0.4 (0.9)	0.53 (1.2)	0.99 (2.2)	1.45 (3.2)	3.0 (6.7)	

Notes:

- The power facility capacity varies depending on the power supply's impedance.
- The figures for regeneration braking frequency indicate the permissible frequency when the motor alone decelerates to a stop from the rated rotation speed. When load is applied, regeneration braking frequency is $1/(m+1)$ of the figure in the table (m = load's moment of inertia/motor's moment of inertia). When the rated rotation speed is exceeded, braking frequency is in inverse proportion to the square of operating speed divided by rated speed. When the operating rotation speed is frequently changing, or when a continuous regeneration condition exists, such as during vertical feed, assess the regeneration heat (W) generated during operation and make sure that it does not exceed the permissible range.
- There are no limits on regeneration frequency as long as the effective torque is within the rated torque range. However, the load/motor of inertia ratio must be 30 or less.
- Contact Mitsubishi if the load/motor of inertia ratio exceeds the figure in the table.
- The vibration direction is shown in this diagram.
- Excluding the shaft-through section and connectors.



HC-MF series servomotor torque characteristics

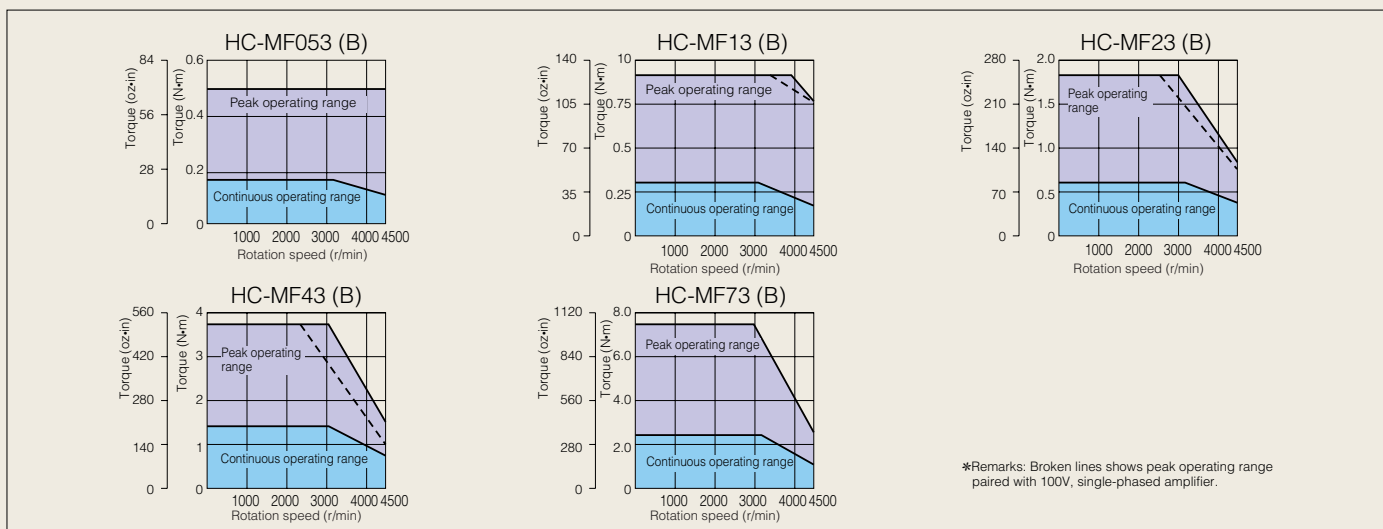

Specifications and Characteristics

HA-FF series servomotor specifications

Servomotor series		HA-FF series (low capacity, low inertia)						
Specifications	Models	FF053 (B)	FF13 (B)	FF23 (B)	FF33 (B)	FF43 (B)	FF63 (B)	
	Servomotor model HA-	MR-J2-10A/A1/B/C		MR-J2-20A/A1/B/C		MR-J2-40A/A1/B/C		
	Servo-amp model	MR-J2-10A/A1/B/C		MR-J2-20A/A1/B/C		MR-J2-40A/A1/B/C		
Servomotor	Power facility capacity (kVA) (note 1)	0.3	0.3	0.5	0.7	0.9	1.1	
	Continuous characteristics	Rated output (W)	50	100	200	300	400	600
		Rated torque (N·m [oz·in])	0.16 (22.7)	0.32 (45.3)	0.64 (90.6)	0.95 (134.5)	1.3 (184.1)	1.9 (269.0)
	Maximum torque (N·m [oz·in])	0.48 (68.0)	0.95 (134.5)	1.9 (269.0)	2.9 (410.6)	3.8 (538.1)	5.7 (807.1)	
	Rated rotation speed (r/min)	3000						
	Maximum rotation speed (r/min)	4000						
	Permissible instantaneous rotation speed (r/min)	4600						
	Power rate (kW/s)	4.0	10.2	11.7	18.1	17.2	30.1	
	Rated current (A)	0.6	1.1	1.3	1.9	2.5	3.6	
	Maximum current (A)	1.8	3.3	3.9	5.7	7.5	10.8	
	Regeneration braking frequency (times/min) (note 2)	With no options	(note 3)	(note 3)	(note 3)	320	150	120
		MR-RB032 (30W)	-	-	-	950	450	360
		MR-RB12 (100W)	-	-	-	3200	1500	1200
	Moment of inertia (figures inside parentheses indicate units with B)	J ($\times 10^{-4}$ kg·m ²)	0.063 (0.08)	0.095 (0.113)	0.35 (0.483)	0.50 (0.633)	0.98 (1.325)	1.20 (1.55)
		J (oz·in ²)	0.344 (0.438)	0.520 (0.618)	1.915 (2.641)	2.74 (3.461)	5.36 (7.24)	6.56 (8.47)
	Recommended load/motor of inertia ratio	10 times the servomotor's moment of inertia max. (note 3)						
	Speed/position detector	Resolution per encoder/servomotor rotation: 8192 P/rev (Can handle up to 32768 P/rev with special specifications. The amp is made to order.)						
Attachments	Encoder, V-ring							
Structure	Totally Enclosed non ventilated (protection degree: IP44)							
Environment	Ambient temperature	0 to 40°C (32 to 104°F) (non freezing), storage: -15 to 70°C (5 to 158°F) (non freezing)						
	Ambient humidity	80% RH max. (non condensing), storage: 90% RH max. (non condensing)						
	Atmosphere	Indoors (no direct sunlight); no corrosive gas, inflammable gas, oil mist, or dust						
	Elevation/vibration (note 4)	1000 meters or less above sea level; X: 19.6 m/s ² (2 G), Y: 19.6 m/s ² (2 G)						
Weight	kg (lb)	1.3 (2.9)	1.5 (3.3)	2.3 (5.1)	2.6 (5.8)	4.2 (9.3)	4.8 (10.7)	

Notes:

- The power facility capacity varies depending on the power supply's impedance.
- The figures for regeneration braking frequency indicate the permissible frequency when the motor alone decelerates to a stop from the rated rotation speed. When load is applied, regeneration braking frequency is $1/(m+1)$ of the figure in the table (m = load's moment of inertia/motor's moment of inertia). When the rated rotation speed is exceeded, braking frequency is in inverse proportion to the square of operating speed divided by rated speed. When the operating rotation speed is frequently changing, or when a continuous regeneration condition exists, such as during vertical feed, assess the regeneration heat (W) generated during operation and make sure that it does not exceed the permissible range.
- Contact Mitsubishi if the load/motor of inertia ratio exceeds the figure in the table.
- The vibration direction is shown in this diagram.



HA-FF series servomotor torque characteristics

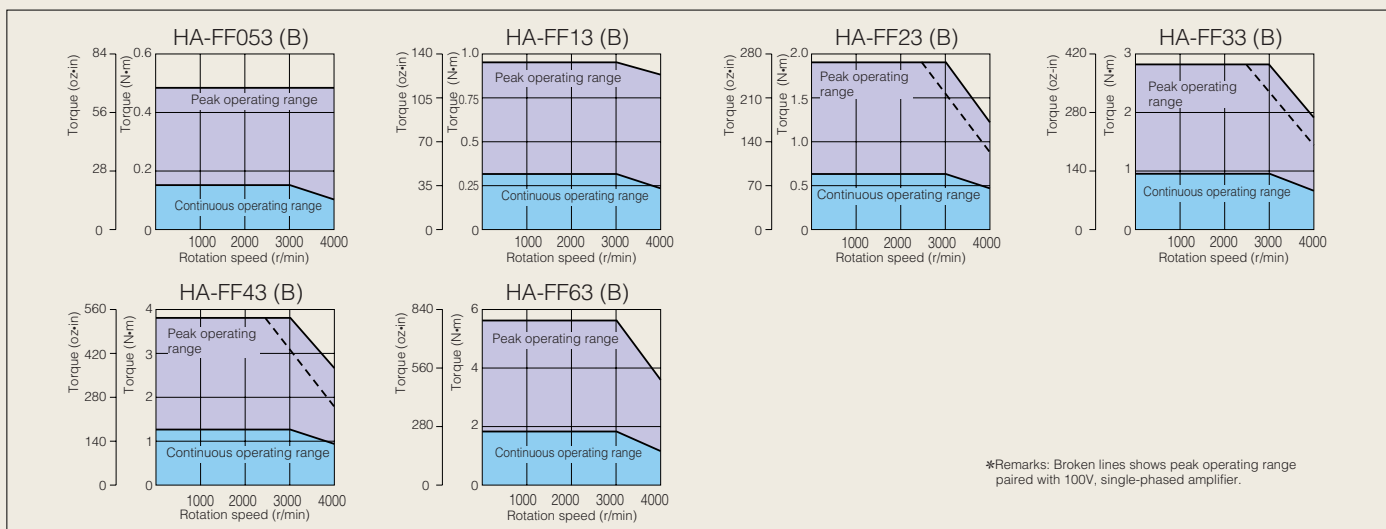

Specifications and Characteristics

HC-SF series servomotor specifications

Servomotor series		HC-SF1000 r/min series (medium inertia, medium capacity)				HC-SF2000 r/min series	
Type	Servomotor model HC-	SF81 (B)	SF121 (B)	SF201 (B)	SF301 (B)	SF52 (B)	SF102 (B)
Specifications	Servo-amp model MR-	J2-100A/B/C	J2-200A/B/C		J2-350A/B/C	J2-60A/B/C	J2-100A/B/C
Power facility capacity (kVA) (note 1)		1.5	2.1	3.5	4.8	1.0	1.7
Continuous characteristics	Rated output (kW)	0.85	1.2	2.0	3.0	0.5	1.0
	Rated torque (N·m [oz·in])	8.12 (1149.8)	11.5 (1628.4)	19.1 (2704.5)	28.6 (4049.4)	2.39 (338.4)	4.78 (676.8)
Maximum torque (N·m [oz·in])		24.4 (3455.0)	34.4 (4871.0)	57.3 (8113.5)	85.9 (12163.2)	7.16 (1013.8)	14.4 (2039.0)
Rated rotation speed (r/min)		1000				2000	
Maximum rotation speed (r/min)		1500	1200		3000		
Permissible instantaneous rotation speed (r/min)		1725	1380		3450		
Power rate (kW/s)		32.9	30.9	44.5	81.3	8.7	16.7
Rated current (A)		5.1	7.1	9.6	16.0	3.2	6
Maximum current (A)		15.3	21.3	28.8	48.0	9.6	18
Regeneration braking frequency (items/min) (note 2)	With no options	140	240	100	84	56	54
	MR-RB032 (30W)	220	—	—	—	165	80
	MR-RB12 (100W)	740	—	—	—	560	270
	MR-RB32 (300W)	2220	—	—	—	1680	810
	MR-RB30 (300W)	—	730	330	250	—	—
Moment of inertia (figures inside parentheses indicate units with B)	J ($\times 10^{-4}$ kg·m ²)	20.0 (22.0)	42.5 (52.5)	82.0 (92)	101 (111)	6.6 (8.6)	13.7 (15.7)
	J (oz·in ²)	109.0 (120.0)	232 (287)	448 (503)	552 (607)	36.1 (47.0)	74.9 (85.8)
Recommended load/motor of inertia ratio		15 times the servomotor's moment of inertia max. (note 3)					
Speed/position encoder		Encoder, Resolution per servomotor revolution: 16384 P/rev					
Attachments		Encoder, oil seal					
Structure		Totally Enclosed non ventilated (protection degree: IP65) (note 5)					
Environment	Ambient temperature	0 to 40°C (32 to 104°F) (non freezing), storage: -15 to 70°C (5 to 158°F) (non freezing)					
	Ambient humidity	80% RH max. (non condensing), storage: 90% RH max. (non condensing)					
	Atmosphere	Indoors (no direct sunlight); no corrosive gas, flammable gas, oil mist, or dust					
	Elevation	1000 meters or less above sea level					
	Vibration (note 4)	X: 9.8m/s ² (1G) Y: 24.5m/s ² (2.5G)	X: 19.6m/s ² (2G) Y: 49m/s ² (5G)	X: 11.7m/s ² (1.2G) Y: 29.4m/s ² (3G)	X: 9.8m/s ² (1G) Y: 24.5m/s ²		
Weight kg (lb)		9 (19.8)	12 (26.5)	19 (41.9)	23 (50.7)	5 (11.0)	7 (15.4)

Notes:

- The power supply capacity varies with the power supply impedance.
- The regenerative brake frequency shown is the permissible frequency for decelerating a stand-alone motor from rated rpm to a stop. When under load, however, the value becomes the table value divided by (m+1) where m is the load inertial moment divided by the motor inertial moment. When the rated rpm is exceeded, the regenerative brake frequency is inversely proportional to the square of (Operating speed/rated speed). When the operating rpm varies with the frequency or when regeneration is constant (as with vertical feeds), find the regeneration heat generated (W) while operating and do not exceed the permissible value.

HC-SF series servomotor torque characteristics

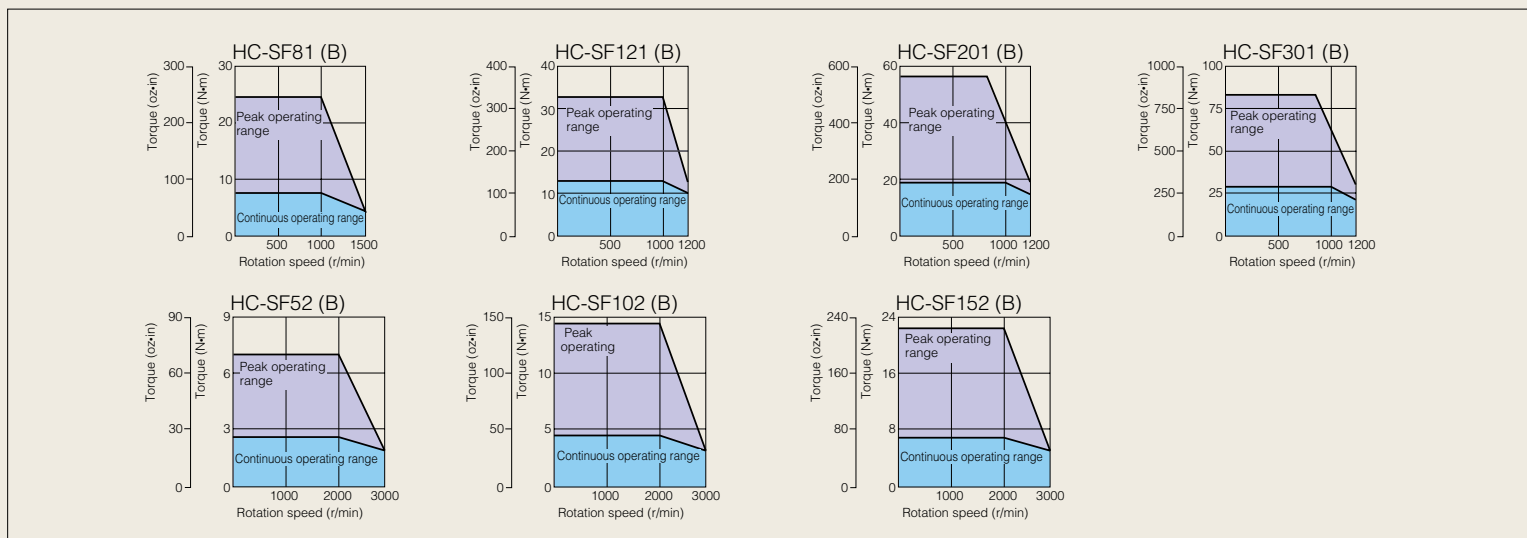

Specifications and Characteristics

(medium inertia, medium capacity)			HC-SF3000 r/min series (medium inertia, medium capacity)					
SF152 (B)	SF202 (B)	SF352 (B)	SF53 (B)	SF103 (B)	SF153 (B)	SF203 (B)	SF353 (B)	
J2-200A/B/C		J2-350A/B/C	J2-60A/B/C	J2-100A/B/C	J2-200A/B/C		J2-350A/B/C	
2.5	3.5	5.5	1.0	1.7	2.5	3.5	5.5	
1.5	2.0	3.5	0.5	1.0	1.5	2.0	3.5	
7.16 (1013.8)	9.55 (1352.3)	16.7 (2364.7)	1.59 (225.1)	3.18 (450.3)	4.78 (676.8)	6.37 (901.9)	11.1 (1571.6)	
21.6 (3058.5)	28.5 (4035.5)	50.1 (7094.0)	4.77 (675.4)	9.55 (1352.3)	14.3 (2024.8)	19.1 (2704.5)	33.4 (4729.3)	
2000			3000					
3000	2500		3000					
3450	2850		3450					
25.6	21.5	34.1	3.8	7.4	11.4	9.5	15.1	
9	11	17	3.2	5.3	8.6	10.4	16.4	
27	33	51	9.6	15.9	25.8	31.2	49.2	
185	53	31	25	24	82	24	14	
—	—	—	73	36	—	—	—	
—	—	—	250	120	—	—	—	
—	—	—	750	360	—	—	—	
560	160	95	—	—	250	70	42	
920	260	150	—	—	410	110	70	
20 (22)	42.5 (52.5)	82 (92)	6.6 (8.6)	13.7 (15.7)	20 (22)	42.5 (52.5)	82 (92)	
109 (120)	232 (287)	448 (503)	36.1 (47.0)	74.9 (85.8)	109 (120)	232 (287)	448 (503)	
15 times the servomotor's moment of inertia max. (note 3)								
(Can handle 131072 P/rev with special specifications. The amp is made to order.) (note 6)								
Encoder, oil seal								
Totally Enclosed non ventilated (protection degree: IP65) (note 5)								
0 to 40°C (32 to 104°F) (non freezing), storage: -15 to 70°C (5 to 158°F) (non freezing)								
80% RH max. (non condensing), storage: 90% RH max. (non condensing)								
Indoors (no direct sunlight); no corrosive gas, flammable gas, oil mist, or dust								
1000 meters or less above sea level								
(2.5G)	X: 19.6m/s ² (2G) Y: 49m/s ² (5G)		X: 9.8m/s ² (1G) Y: 24.5m/s ² (2.5G)			X: 19.6m/s ² (2G) Y: 49m/s ² (5G)		
9 (19.8)	12 (26.5)	19 (41.9)	5 (11.0)	7 (15.4)	9 (19.8)	12 (26.5)	19 (41.9)	

3. Contact Mitsubishi if you must exceed the stated load inertial moment ratio.
 4. The directions of vibration are as follows.



5. Cannot be used with model MR-J2-C. Contact Mitsubishi for details.

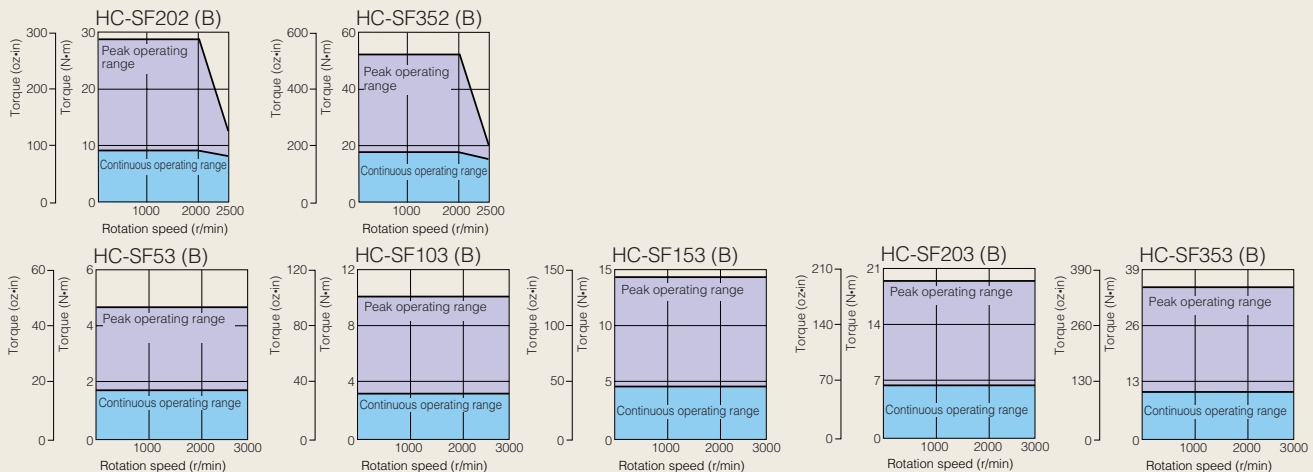

Specifications and Characteristics

HC-RF series servomotor specifications

Servomotor series		HC-RF series (low inertia)			
Specifications	Models	RF103 (B)	RF153 (B)	RF203 (B)	
	Servomotor model HC-	MR-J2-200A/B/C			
Servo-amp model		MR-J2-350A/B			
Servomotor	Power facility capacity (kVA) (note 1)	1.7	2.5	3.5	
	Continuous characteristics	Rated output (kW)	1.0	1.5	2.0
		Rated torque (N·m [oz·in])	3.18 (450.3)	4.78 (676.8)	6.37 (902.0)
	Maximum torque (N·m [oz·in])	7.95 (1125.7)	11.9 (1685.0)	15.9 (2251.4)	
	Rated rotation speed (r/min)	3000			
	Maximum rotation speed (r/min)	4500			
	Permissible instantaneous rotation speed (r/min)	5175			
	Power rate (kW/s)	67.4	120	176	
	Rated current (A)	6.1	8.8	14	
	Maximum current (A)	18.4	23.4	37	
	Regeneration braking frequency (times/min) (note 2)	With no options	1090	860	710
		MR-RB30 (300W)	3270	2580	2130
		MR-RB50 (500W)	5450	4300	3550
	Moment of inertia (figures inside parentheses indicate units with B)	J ($\times 10^{-4}$ kg·m ²)	1.5 (1.85)	1.9 (2.25)	2.3 (2.65)
		J (oz·in ²)	8.20 (10.1)	10.4 (12.3)	12.6 (14.5)
	Recommended load/moment of inertia ratio	5 times the servomotor's moment of inertia max. (note 3)			
	Speed/position encoder	Resolution per encoder/servomotor rotation: 16384 P/rev (Can handle up to 131072 P/rev with special specifications. The amp is made to order.)			
Attachments	Encoder, oil seal				
Structure	Totally Enclosed non ventilated (protection degree: IP65)				
Environment	Ambient temperature	0 to 40°C (32 to 104°F) (non freezing), storage: -15 to 70°C (5 to 158°F) (non freezing)			
	Ambient humidity	80% RH max. (non condensing), storage: 90% RH max. (non condensing)			
	Atmosphere	Indoors (no direct sunlight); no corrosive gas, inflammable gas, oil mist, or dust			
	Elevation/vibration (note 4)	1000 meters or less above sea level; X: 9.8 m/s ² (1 G), Y: 24.5 m/s ² (2.5 G)			
Weight	kg (lb)	3.9 (8.7)	5.0 (11.1)	6.2 (13.8)	

Notes:

- The power facility capacity varies depending on the power supply's impedance.
- The figures for regeneration braking frequency indicate the permissible frequency when the motor alone decelerates to a stop from the rated rotation speed. Below 200, there are no limits on regeneration as long as the effective torque is within the rated torque range. When load is applied, regeneration braking frequency is $1/(m+1)$ of the figure in the table (m = load's moment of inertia/motor's moment of inertia). When the rated rotation speed is exceeded, the permissible number of times is in inverse proportion to the square of operating speed divided by rated speed. When the operating rotation speed is frequently changing, or when a continuous regeneration condition exists, such as during up/down feed, the regeneration heat generated during operation must be assessed and measures taken to make sure that it does not exceed the permissible range.
- Contact Mitsubishi if the load/motor of inertia ratio exceeds the figure in the table.
- The vibration direction is shown in this diagram.



HC-RF series servomotor torque characteristics

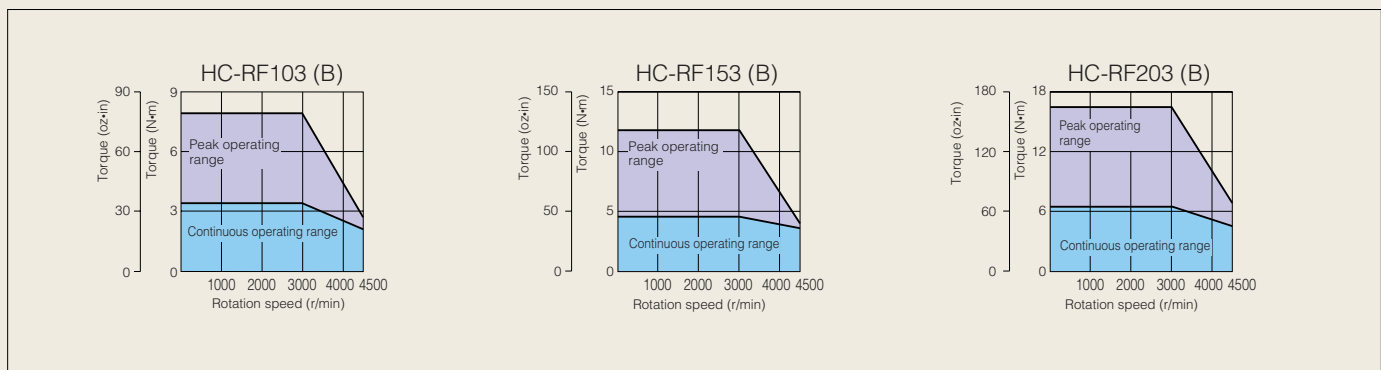

Specifications and Characteristics

HC-UF series servomotor specifications

Servomotor series		HC-UF2000r/min series (flat model, medium capacity)			HC-UF3000r/min series (flat model, low capacity)			
Specifications	Type	UF72 (B)	UF152 (B)	UF202 (B)	UF13 (B)	UF23 (B)	UF43 (B)	UF73 (B)
	Servomotor model HC- Servo-amp model MR-	J2-70A/B/C	J2-200A/B/C	J2-350A/B/C	J2-10A/A1/B/C	J2-20A/A1/B/C	J2-40A/A1/B/C	J2-70A/B/C (note 8)
Power facility capacity (kVA) (note 1)		1.3	2.5	3.5	0.3	0.5	0.9	1.3
Continuous characteristics	Rated output (kW)	0.75	1.5	2.0	0.1	0.2	0.4	0.75
	Rated torque (N·m [oz·in])	3.58 (506.9)	7.16 (1013.8)	9.55 (1352.3)	0.32 (45.3)	0.64 (90.6)	1.3 (184.1)	2.4 (339.8)
Maximum torque (N·m [oz·in])		10.7 (1515.1)	21.6 (3058.5)	28.5 (4035.5)	0.95 (134.5)	1.9 (269.0)	3.8 (538.1)	7.2 (1019.5)
Rated rotation speed (r/min)		2000			3000			
Maximum rotation speed (r/min)		3000			4500			
Permissible instantaneous rotation speed (r/min)		3450			5175			
Power rate (kW/s)		12.3	23.2	23.9	15.5	19.2	47.7	9.66
Rated current (A)		5.4	9.7	14	0.76	1.5	2.8	4.3
Maximum current (A)		16.2	29.1	42	2.5	4.95	9.24	12.9
Regeneration braking frequency (items/min) (note 2)	With no options	73	130	89	(note 6)	(note 6)	410	41
	MR-RB032 (30W)	109	—	—	—	—	1230	62
	MR-RB12 (100W)	365	—	—	—	—	4100	206
	MR-RB32 (300W)	1090	—	—	—	—	—	—
	MR-RB30 (300W)	—	390	260	—	—	—	—
Moment of inertia (figures inside parentheses indicate units with B)	J ($\times 10^{-4}$ kg·m ²)	10.4 (12.4)	22.1 (24.1)	38.2 (46.8)	0.066 (0.074)	0.241 (0.323)	0.365 (0.447)	5.90 (6.10)
	J (oz·in ²)	56.8 (67.8)	120.8 (131.7)	209 (255.7)	0.361 (0.404)	1.315 (1.762)	1.994 (2.445)	32.2 (33.3)
Recommended load/motor of inertia ratio		15 times the servomotor's moment of inertia max. (note 3)						
Speed/position encoder		Encoder, Resolution per servomotor revolution: 16384 P/rev (Can handle 131072 P/rev with special specifications. The amp is made to order.) (note 7)			Encoder, Resolution per servomotor revolution: 8192 P/rev (Can handle 32768 P/rev with special specifications. The amp is made to order.) (note 7)			
Attachments		Encoder, oil seal						
Structure		Totally Enclosed non ventilated (protection degree: IP65) (note 5)						
Environment	Ambient temperature	0 to 40°C (32 to 104°F) (non freezing), storage: -15 to 70°C (5 to 158°F) (non freezing)						
	Ambient humidity	80% RH max. (non condensing), storage: 90% RH max. (non condensing)						
	Atmosphere	Indoors (no direct sunlight); no corrosive gas, flammable gas, oil mist, or dust						
	Elevation	1000 meters or less above sea level						
Vibration (note 4)		X: 9.8m/s ² (1G) Y: 24.5m/s ² (2.5G)		X: 19.6m/s ² (2G) Y: 49m/s ² (5G)	X, Y: 19.6m/s ² (2G)			
Weight kg (lb)		8.0 (17.6)	11.0 (24.3)	16.0 (35.3)	0.8 (1.8)	1.5 (3.3)	1.7 (3.7)	5.0 (11.0)

Notes:

- The power supply capacity varies with the power supply impedance.
- The regenerative brake frequency shown is the permissible frequency for decelerating a stand-alone motor from rated rpm to a stop. When under load, however, the value becomes the table value divided by (m+1) where m is the load inertial moment divided by the motor inertial moment. When the rated rpm is exceeded, the regenerative brake frequency is inversely proportional to the square of (Operating speed/rated speed). When the operating rpm varies with the frequency or when regeneration is constant (as with vertical feeds), find the regeneration heat generated (W) while operating and do not exceed the permissible value.
- Contact Mitsubishi if you must exceed the stated load inertial moment ratio.
- The directions of vibration are as follows.
 
- Regeneration frequency is not restricted if the effective torque is within the rated torque range.
- Cannot be used with model MR-J2-C. Contact Mitsubishi for details.
- The MR-J2-A series currently covers the HC-UF73 with model MR-J2-70A-A030.

HC-UF series servomotor torque characteristics

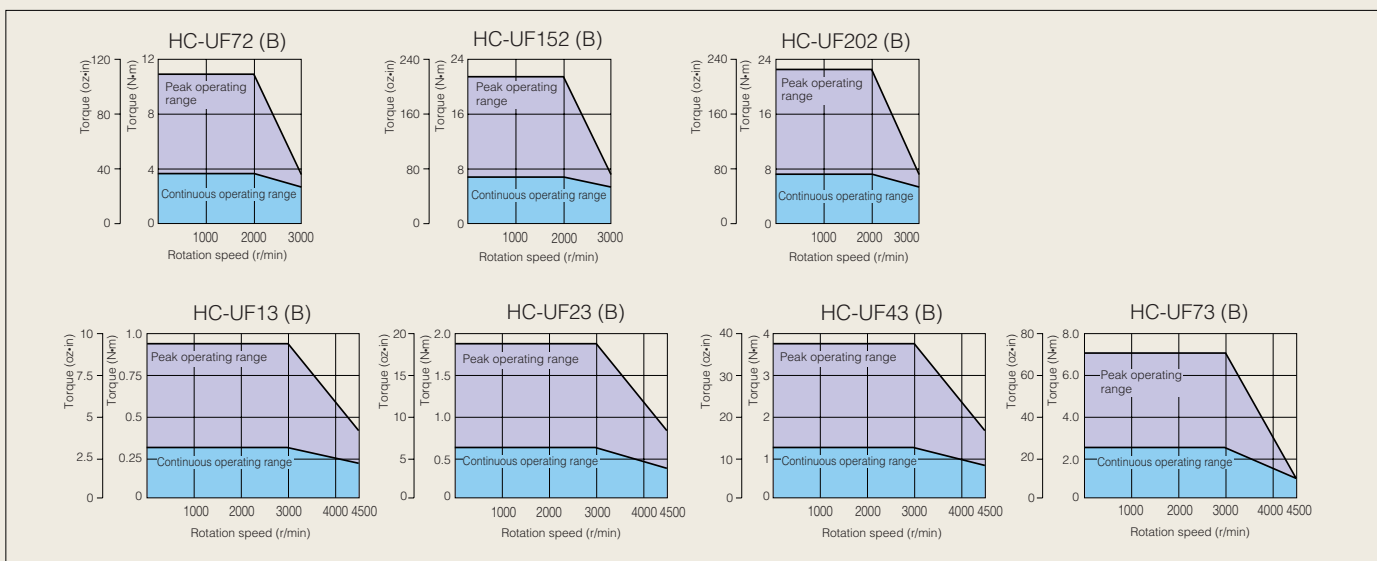

Motor Dimensions

● HC-MF053 (B), HC-MF13 (B)

Unit: mm (inch)

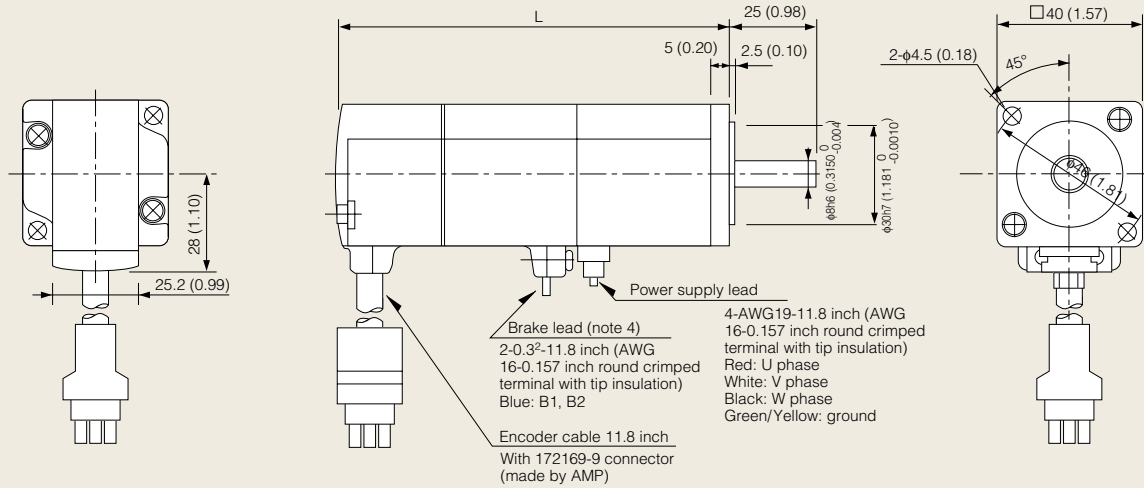

Model	Variable dimensions L
HC-MF053 (B)	81.5 (3.21) <109.5 (4.30)>
HC-MF13 (B)	96.5 (3.80) <124.5 (4.90)>

● HC-MF23 (B), HC-MF43 (B)

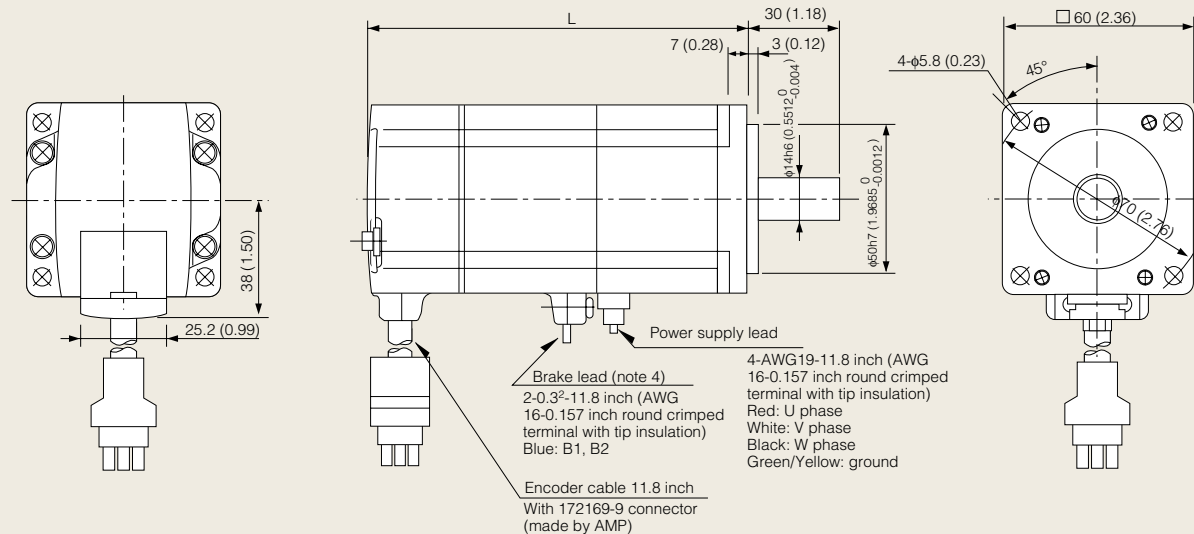

Model	Variable dimensions L
HC-MF23 (B)	99.5 (3.92) <131.5 (5.18)>
HC-MF43 (B)	124.5 (4.90) <156.5 (6.16)>

Notes:

1. When mounting the servomotor horizontally we recommend encoder connector to be mounted downward.
2. Use a friction coupling to fasten the load.
3. Dimensions inside < > are for models with electromagnetic brakes.
4. Only for models with electromagnetic brakes.

Motor Dimensions

● HC-MF73 (B)

Unit: mm (inch)

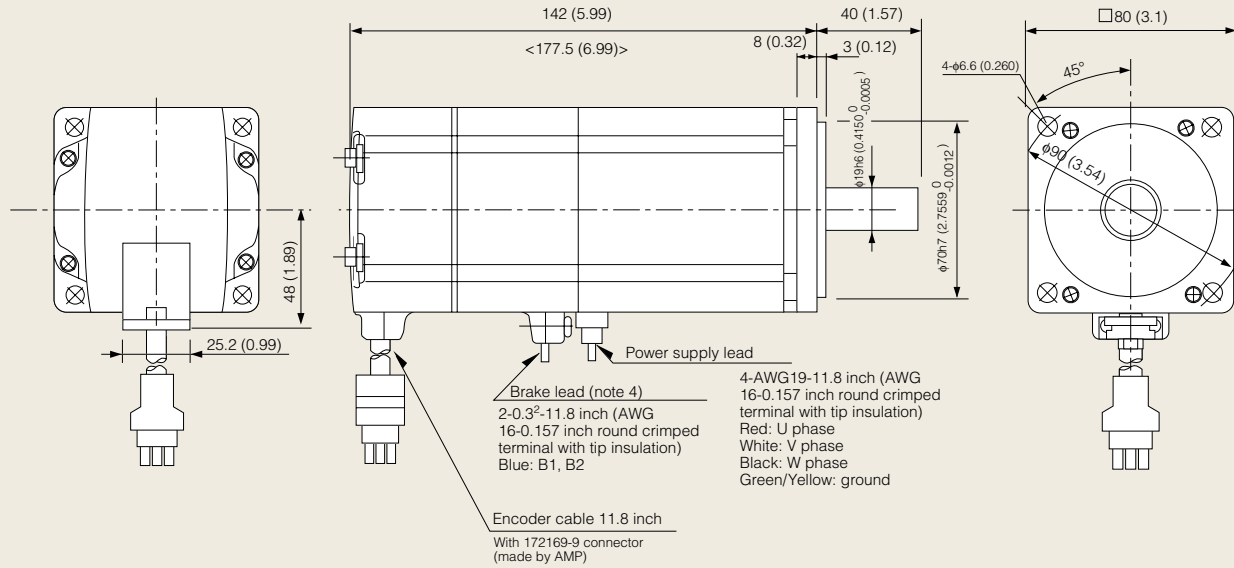

Notes:

1. When mounting the servomotor horizontally we recommend encoder connector to be mounted downward.
2. Use a friction coupling to fasten the load.
3. Dimensions inside < > are for models with electromagnetic brakes.
4. Only for models with electromagnetic brakes.

Motor Dimensions

● HA-FF053 (B), HA-FF13 (B)

Unit: mm (inch)

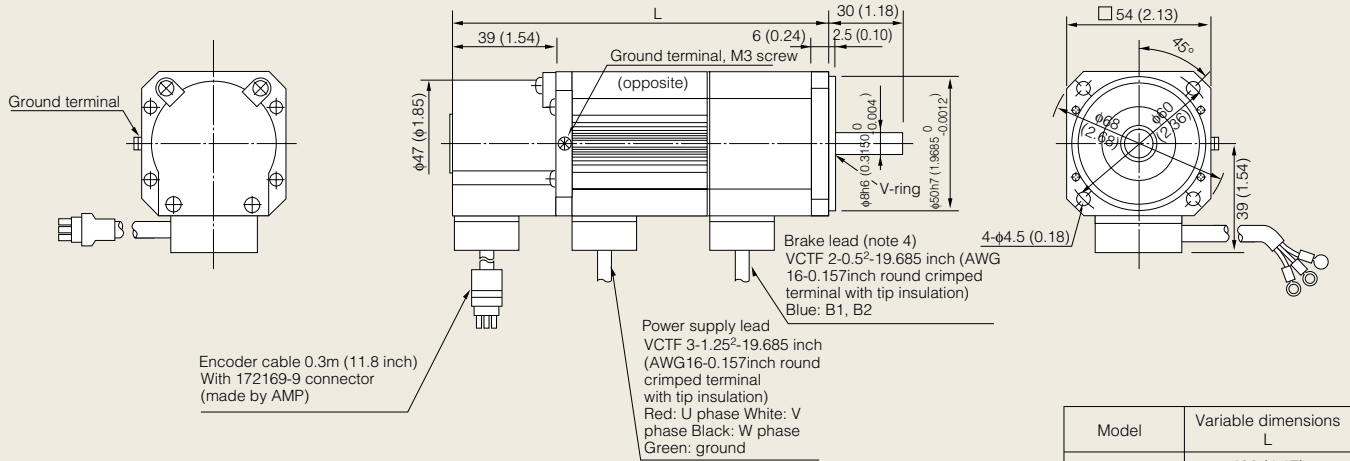

Model	Variable dimensions L
HA-FF053 (B)	106 (4.17) <141 (5.55)>
HA-FF13 (B)	123 (4.84) <158 (6.22)>

● HA-FF23 (B), HA-FF33 (B)

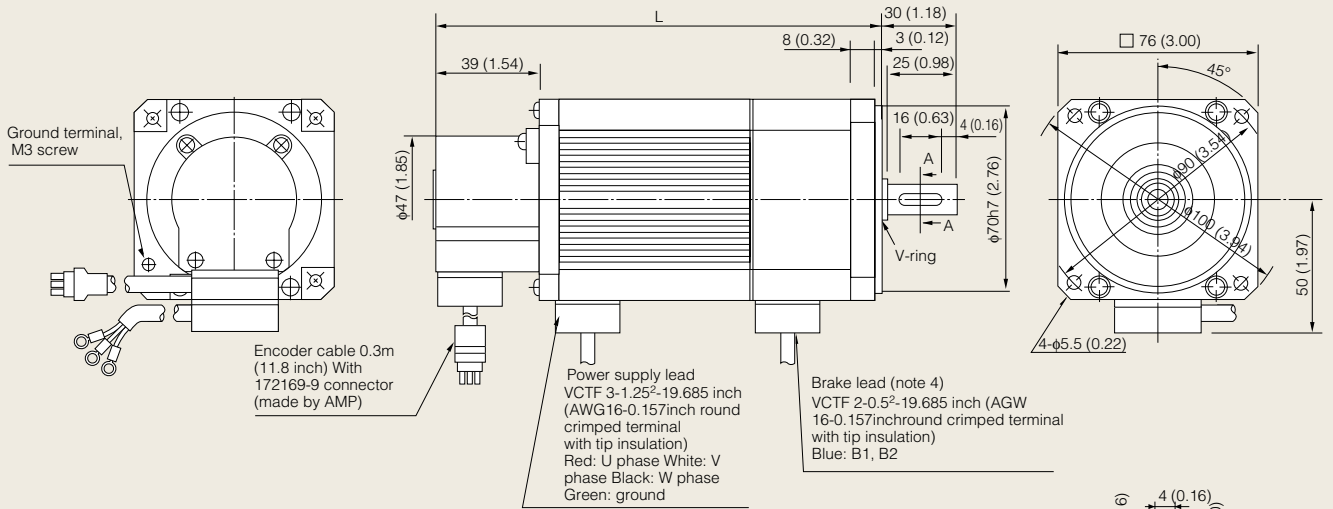

Model	Variable dimensions L
HA-FF23 (B)	131 (5.16) <168 (6.61)>
HA-FF33 (B)	148 (5.83) <186 (7.32)>

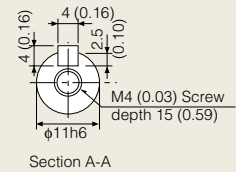

Notes:

1. When mounting the servomotor horizontally we recommend encoder connector to be mounted downward.
2. Use a friction coupling to fasten the load.
3. Dimensions inside < > are for models with electromagnetic brakes.
4. Only for models with electromagnetic brakes.

Motor Dimensions

● HA-FF43 (B), HA-FF63 (B)

Unit: mm (inch)

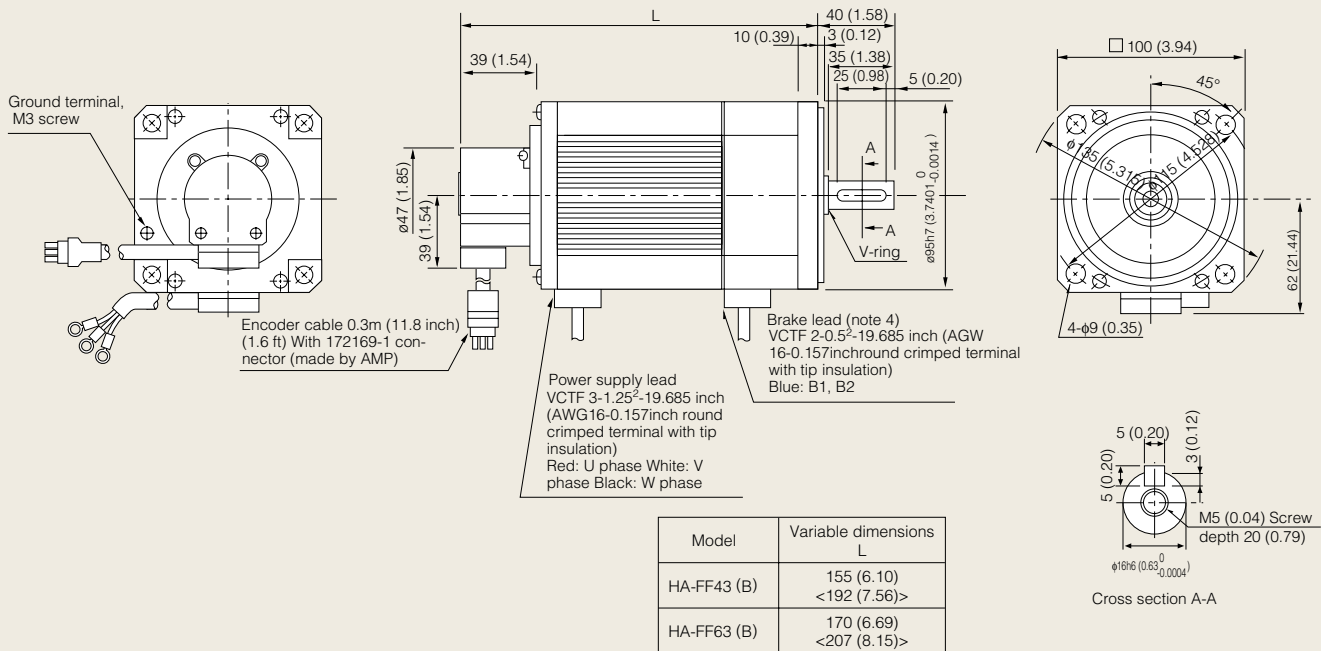

Notes:

1. When mounting the servomotor horizontally we recommend encoder connector to be mounted downward.
2. Use a friction coupling to fasten the load.
3. Dimensions inside < > are for models with electromagnetic brakes.
4. Only for models with electromagnetic brakes.

Motor Dimensions

- HC-SF81 (B)
- HC-SF52 (B)~HC-SF152 (B)
- HC-SF53 (B)~HC-SF153 (B)

Unit: mm (inch)

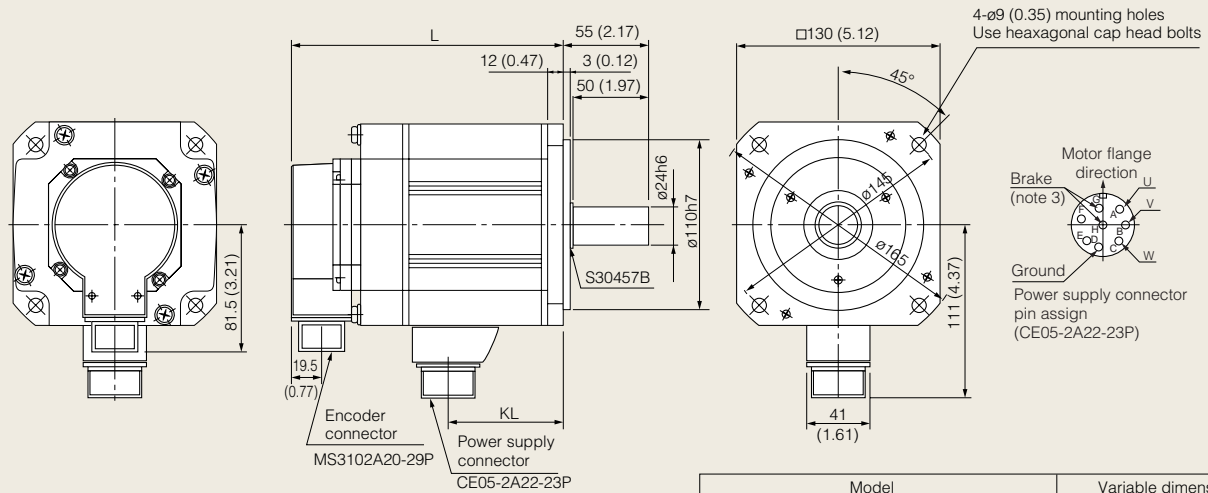

Model			Variable dimensions	
1000 r/min	2000 r/min	3000 r/min	L	KL
—	HC-SF52 (B)	HC-SF53 (B)	120 (4.72) <153 (6.03)>	51.5 (2.03)
—	HC-SF102 (B)	HC-SF103 (B)	145 (5.71) <178 (7.01)>	76.5 (3.01)
HC-SF81 (B)	HC-SF152 (B)	HC-SF153 (B)	170 (6.69) <203 (7.99)>	101.5 (4.00)

- HC-SF121 (B)~HC-SF301 (B)
- HC-SF202 (B)~HC-SF352 (B)
- HC-SF203 (B)~HC-SF353 (B)

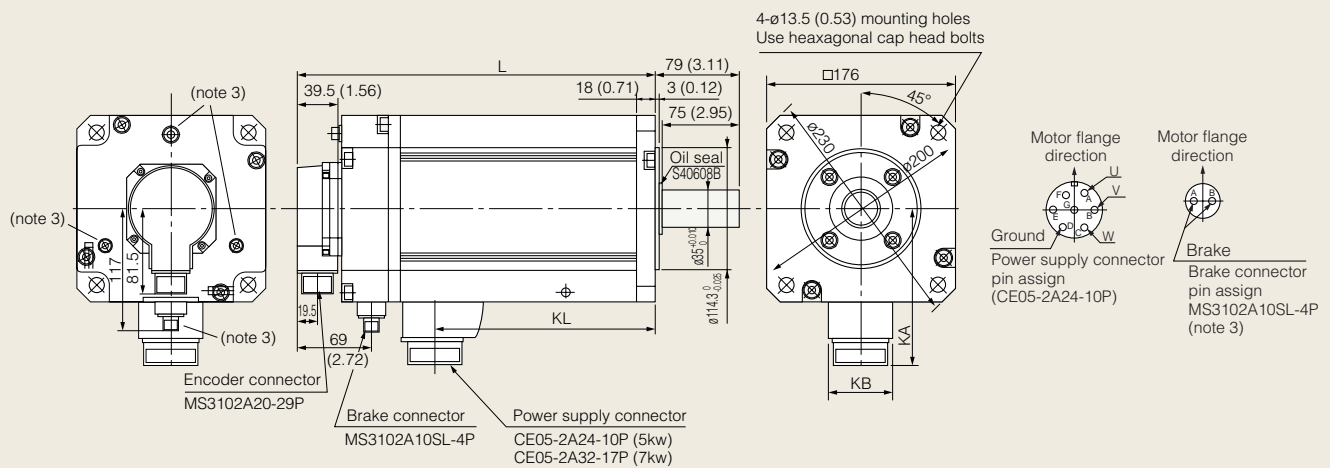

Model			Variable dimensions			
1000 r/min	2000 r/min	3000 r/min	L	KL	KA	KB
HC-SF121 (B)	HC-SF202(B)	HC-SF203 (B)	145 (5.71) <193 (7.60)>	68.5 (2.70)	142 (5.60)	46 (1.81)
HC-SF201 (B)	HC-SF352 (B)	HC-SF353 (B)	187 (7.36) <235 (9.25)>	110.5 (4.35)	142 (5.60)	46 (1.81)
HC-SF301 (B)	—	—	208 (8.19) <256 (10.08)>	131.5 (5.18)	142 (5.60)	46 (1.81)

Notes:

1. Use a friction coupling to fasten the load.
2. Dimensions inside < > are for models with electromagnetic brakes.
3. Only for models with electromagnetic brakes.
4. The inertial moment value in the table is the motor axis conversion value (motor+decelerator).

Motor Dimensions

● HC-RF103 (B), HC-RF153 (B), HC-RF203 (B)

Unit: mm (inch)

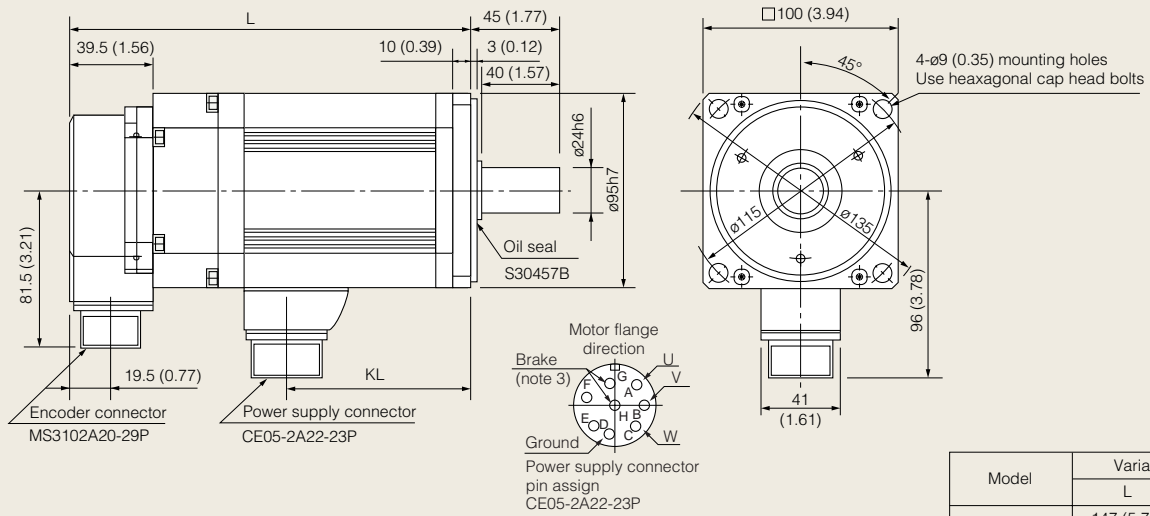

Model	Variable dimensions	
	L	KL
HC-RF103 (B)	147 (5.79) <185 (7.28)>	71 (2.80)
HC-RF153 (B)	172 (6.77) <210 (8.27)>	96 (3.78)
HC-RF203 (B)	197 (7.76) <235 (9.25)>	121 (4.76)

Notes:

1. Use a friction coupling to fasten the load.
2. Dimensions inside < > are for models with electromagnetic brakes.
3. Only for models with electromagnetic brakes.

Motor Dimensions

● HC-UF72 (B), HC-UF152 (B)

Unit: mm (inch)

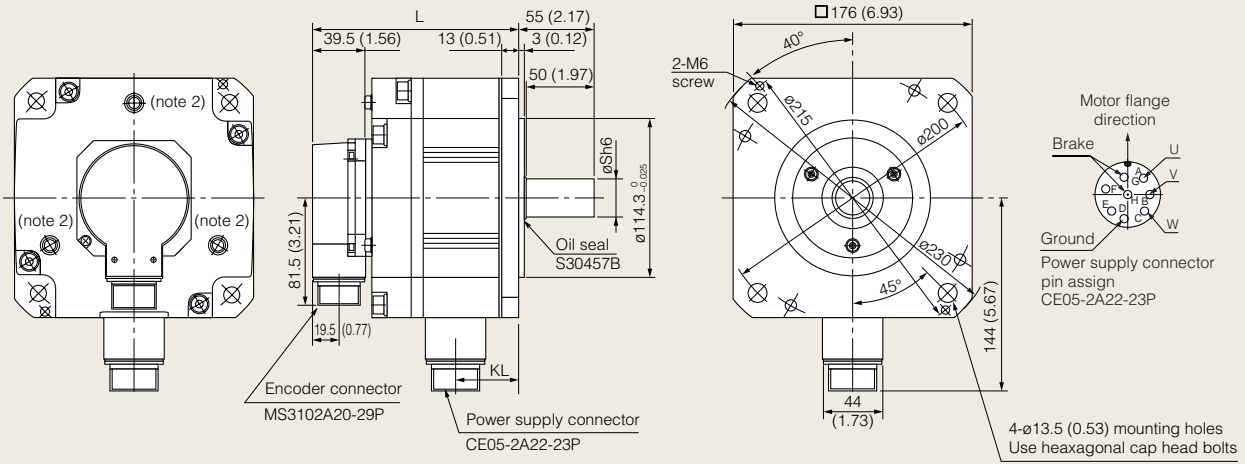

Model	Variable dimensions		
	L	KL	S
HC-UF72 (B)	110.5 (4.35) <144 (5.67)>	38 (1.50)	22 (0.87)
HC-UF152 (B)	120 (4.72) <153.5 (6.04)>	47.5 (1.87)	28 (1.10)

● HC-UF202 (B)

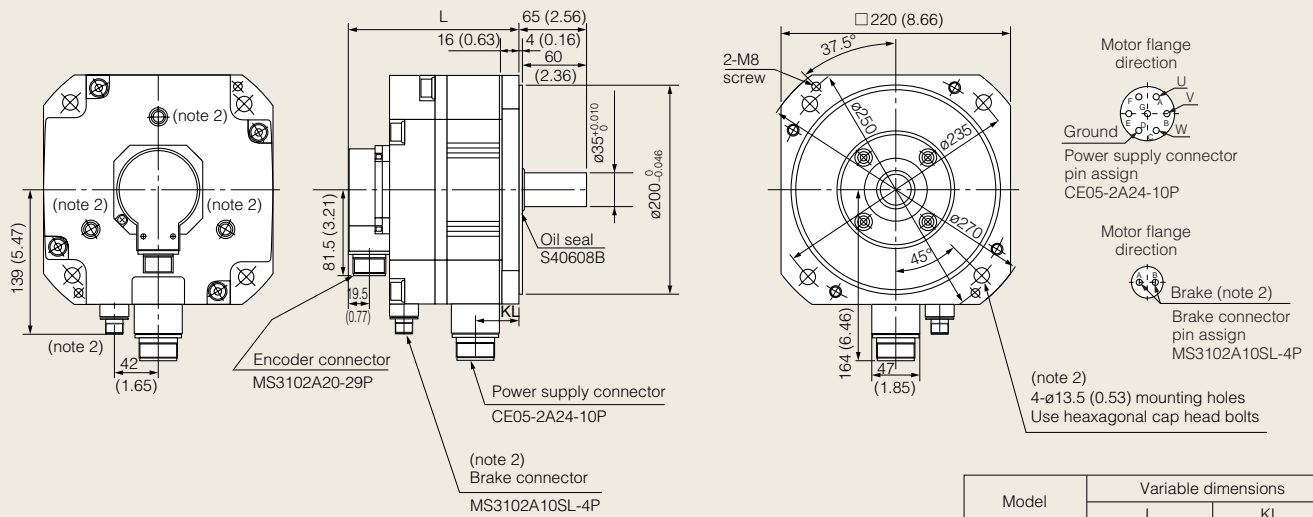

Model	Variable dimensions	
	L	KL
HC-UF202 (B)	118 (0.04) <161 (6.34)>	42.5 (1.67)

Notes:

1. Use a friction coupling to fasten the load.
2. Dimensions inside < > are for models with electromagnetic brakes.
3. Only for models with electromagnetic brakes.

Motor Dimensions

● HC-UF13 (B)

Unit: mm (inch)

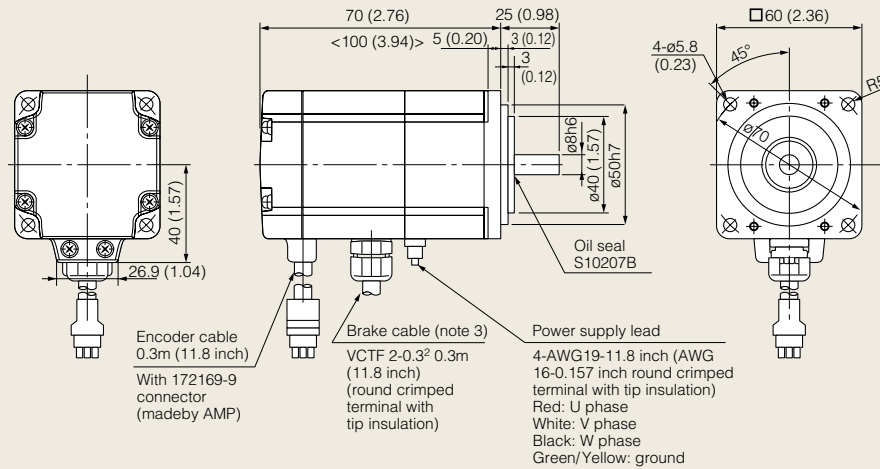

● HC-UF23 (B), HC-UF43 (B)

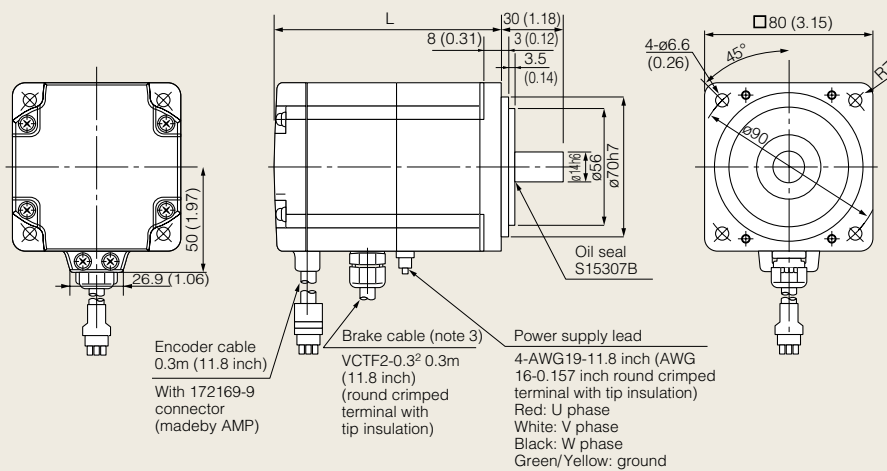

Model	Variable dimensions
	L
HC-UF23 (B)	75 (2.95) <109 (4.29)>
HC-UF43 (B)	90 (3.54) <124 (4.88)>

● HC-UF73 (B)

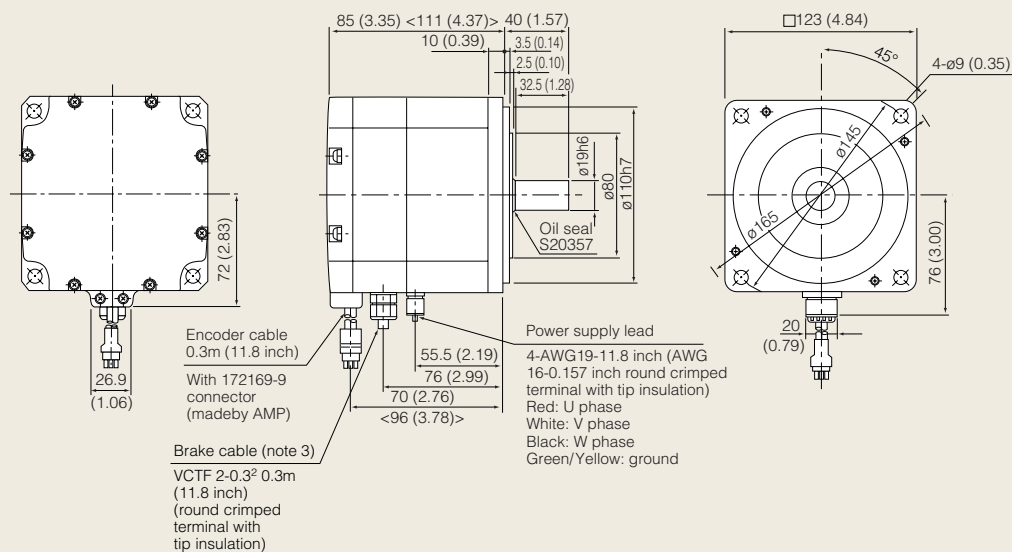

Notes:

1. Use a friction coupling to fasten the load.
2. Dimensions inside < > are for models with electromagnetic brakes.
3. Only for models with electromagnetic brakes.

Special Specifications

Electromagnetic brake specifications

Motor model	HC-MF					HA-FF						HC-SF1000 r/min				
	053B	13B	23B	43B	73B	053B	13B	23B	33B	43B	63B	81B	121B	201B	301B	
Type	Spring-action safety brake					Spring-action safety brake						Spring-action safety brake				
Rated voltage	DC24V _{-10%}					DC24V _{-10%}						DC24V _{-10%}				
Static friction torque (N-m)	0.32	0.32	1.3	1.3	2.4	0.39	0.39	1.18	1.18	2.3	2.3	8.3	43.1	43.1	43.1	
Rated current (A) at 20°C	0.26	0.26	0.33	0.33	0.42	0.22	0.22	0.31	0.31	0.46	0.46	0.8	1.4	1.4	1.4	
Coil resistance (Ω) at 20°C	91	91	73	73	57	111	111	78	78	52	52	29	16.8	16.8	16.8	
Power consumption (W) at 20°C	6.3	6.3	7.9	7.9	10	7	7	7.4	7.4	11	11	19	34	34	34	
Permissible braking volume	(N-m)/time	5.6	5.6	22	22	64	3.9	3.9	18	18	46	46	400	4500	4500	4500
	(N-m)/hour	56	56	220	220	640	39	39	180	180	460	460	4000	45000	45000	45000
Brake life (note 1) (Brake volume per braking action)	20000 (4N-m)	20000 (4N-m)	20000 (15N-m)	20000 (15N-m)	20000 (32N-m)	30000 (4N-m)	30000 (4N-m)	30000 (18N-m)	30000 (18N-m)	30000 (47N-m)	30000 (47N-m)	20000 (200N-m)	20000 (200N-m)	20000 (200N-m)	20000 (200N-m)	

Motor model	HC-SF2000 r/min					HC-SF3000 r/min					HC-RF			HC-UF2000 r/min			HC-UF3000 r/min				
	52B	102B	152B	202B	352B	53B	103B	153B	203B	353B	103B	153B	203B	72B	152B	202B	13B	23B	43B	73B	
Type	Spring-action safety brake					Spring-action safety brake					Spring-action safety brake			Spring-action safety brake			Spring-action safety brake				
Rated voltage	DC24V _{-10%}					DC24V _{-10%}					DC24V _{-10%}			DC24V _{-10%}			DC24V _{-10%}				
Static friction torque (N-m)	8.3	8.3	8.3	43.1	43.1	8.3	8.3	8.3	43.1	43.1	6.8	6.8	6.8	8.3	8.3	43.1	0.32	1.3	1.3	2.4	
Rated current (A) at 20°C	0.8	0.8	0.8	1.4	1.4	0.8	0.8	0.8	1.4	1.4	0.8	0.8	0.8	0.8	0.8	1.4	0.26	0.33	0.33	0.42	
Coil resistance (Ω) at 20°C	29	29	29	16.8	16.8	29	29	29	16.8	16.8	30	30	30	29	29	16.8	91	73	73	57	
Power consumption (W) at 20°C	19	19	19	34	34	19	19	19	34	34	19	19	19	19	19	34	6.3	7.9	7.9	10	
Permissible braking volume	(N-m)/time	400	400	400	4500	4500	400	400	400	4500	4500	400	400	400	400	400	4500	5.6	22	22	64
	(N-m)/hour	4000	4000	4000	45000	45000	4000	4000	4000	45000	45000	4000	4000	4000	4000	4000	45000	56	220	220	640
Brake life (note 1) (Brake volume per braking action)	20000 (200N-m)	20000 (200N-m)	20000 (200N-m)	20000 (1000N-m)	20000 (1000N-m)	20000 (200N-m)	20000 (200N-m)	20000 (200N-m)	20000 (200N-m)	20000 (1000N-m)	20000 (200N-m)	20000 (200N-m)	20000 (200N-m)	20000 (200N-m)	20000 (200N-m)	20000 (1000N-m)	20000 (4N-m)	20000 (15N-m)	20000 (15N-m)	20000 (32N-m)	

Notes:

- The brake gap cannot be adjusted, so the brake life is the time until readjustment by braking needed.
- The electromagnetic brake is for holding. It cannot be used for braking applications.

Special shaft end specifications

We can manufacture shaft ends to order meeting the following specifications.

HC-MF, UF3000r/min series

● With key (200, 400, 750W) Variable dimension table

Motor series	Capacity (kW)	Variable dimensions									
		T	S	R	Q	W	QK	QL	U	Y	
HC-MF	200, 400	5 (0.20)	14h6	30 (1.18)	27 (1.06)	5 (0.20)	20 (0.79)	3 (0.12)	3 (0.12)	M4 (0.028) screws Depth: 15mm (0.59 inch)	
	750	6 (0.24)	19h6	40 (1.57)	37 (1.46)	6 (0.24)	25 (0.98)	5 (0.20)	3.5 (0.14)	M5 (0.035) screws Depth: 20mm (0.79 inch)	
HC-UF	200, 400	5 (0.20)	14h6	30 (1.18)	23.5 (0.93)	5 (0.20)	20 (0.79)	3 (0.12)	3 (0.12)	M4 (0.028) screws Depth: 15mm (0.59 inch)	
	750	6 (0.24)	19h6	40 (1.57)	32.5 (1.28)	6 (0.24)	25 (0.98)	5 (0.20)	3.5 (0.14)	M5 (0.035) screws Depth: 20mm (0.79 inch)	

(note 1)

● D-cut (50, 100W) Variable dimension table

Motor series	Capacity (kW)	Variable dimensions	
		R	Q
HC-MF	50, 100	25 (0.98)	20.5 (0.81)
HC-UF	100	25 (0.98)	17.5 (0.69)

(note 1)

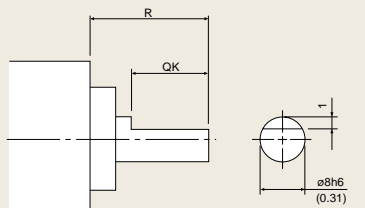

Unit: mm (inch)

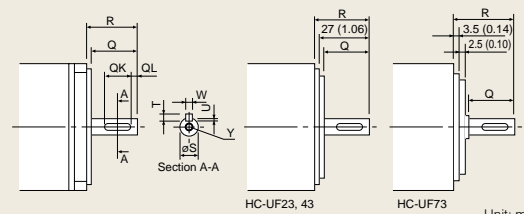

Unit: mm (inch)

HA-FF series

● D-cut (50, 100W)

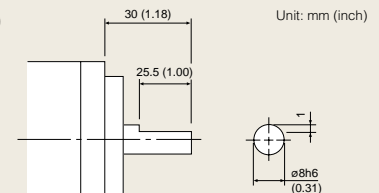

Unit: mm (inch)

HC-SF, RF, UF2000r/min series

● Key way Variable dimension table

Motor series	Capacity (kW)	Variable dimensions									
		S	R	Q	W	QK	QL	U	r	Y	
HC-SF (note 3)	0.5-1.5	24h6	55 (2.17)	50 (1.97)	8 (0.31) 0 ^{+0.036}	36 (1.42)	5 (0.20)	4 (0.16) 0 ^{+0.2}	4 (0.16)	M8 (0.056) screws Depth: 20mm (0.79 inch)	
	2-3.5	35 ^{+0.01} ₀	79 (3.11)	75 (2.95)	10 (0.39) 0 ^{-0.036}	55 (2.17)	5 (0.20)	5 (0.20) 0 ^{+0.2}	5 (0.20)		
HC-RF	1, 1.5, 2	24h6	45 (1.77)	40 (1.57)	8 (0.31) 0 ^{-0.036}	25 (0.98)	5 (0.20)	4 (0.16) 0 ^{+0.2}	4 (0.16)		
	0.75	22h6	55 (2.17)	50 (1.97)	6 (0.24) 0 ^{-0.030}	42 (1.65)	3 (0.12)	3.5 (0.14) 0 ^{+0.2}	3 (0.12)		
HC-UF	1.5	28h6	55 (2.17)	50 (1.97)	8 (0.31) 0 ^{-0.036}	45 (1.77)	5 (0.20)	4 (0.16) 0 ^{+0.2}	4 (0.16)		
	2	35h6	65 (2.56)	60 (2.36)	10 (0.39) 0 ^{-0.030}	55 (2.17)	5 (0.20)	5 (0.20) 0 ^{+0.2}	5 (0.20)		

(note 2)

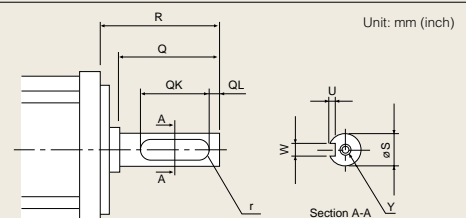

Unit: mm (inch)

Notes:

- Cannot be used in applications that involve high frequency. We make no guarantees regarding shaft damage caused by rattling of keys, so use a friction coupling, [illegible] ring, or the like.
- Keys are not installed. Keys are installed by the purchaser.
- The HC-SF121 is the same as the lower row (2-3.5kW).

SERVO AMPLIFIERS MELSERVO J2-A

Global Applications for Superb Operation in the Toughest Environments

- Satisfies global industrial standards
- Separate wiring of the control power supply
- Real-time auto-tuning, and high responsiveness
 - Torque control function
- Servo lock anti-vibration function
- Personal computer interface as standard
 - Automatic motor recognition



Peripheral Equipment

Connections with peripheral equipment

Peripheral equipment is connected to the MR-J2-A as described below.

Connectors, options, and other necessary equipment are available to allow users to easily setup the J2-A and begin using it right away!

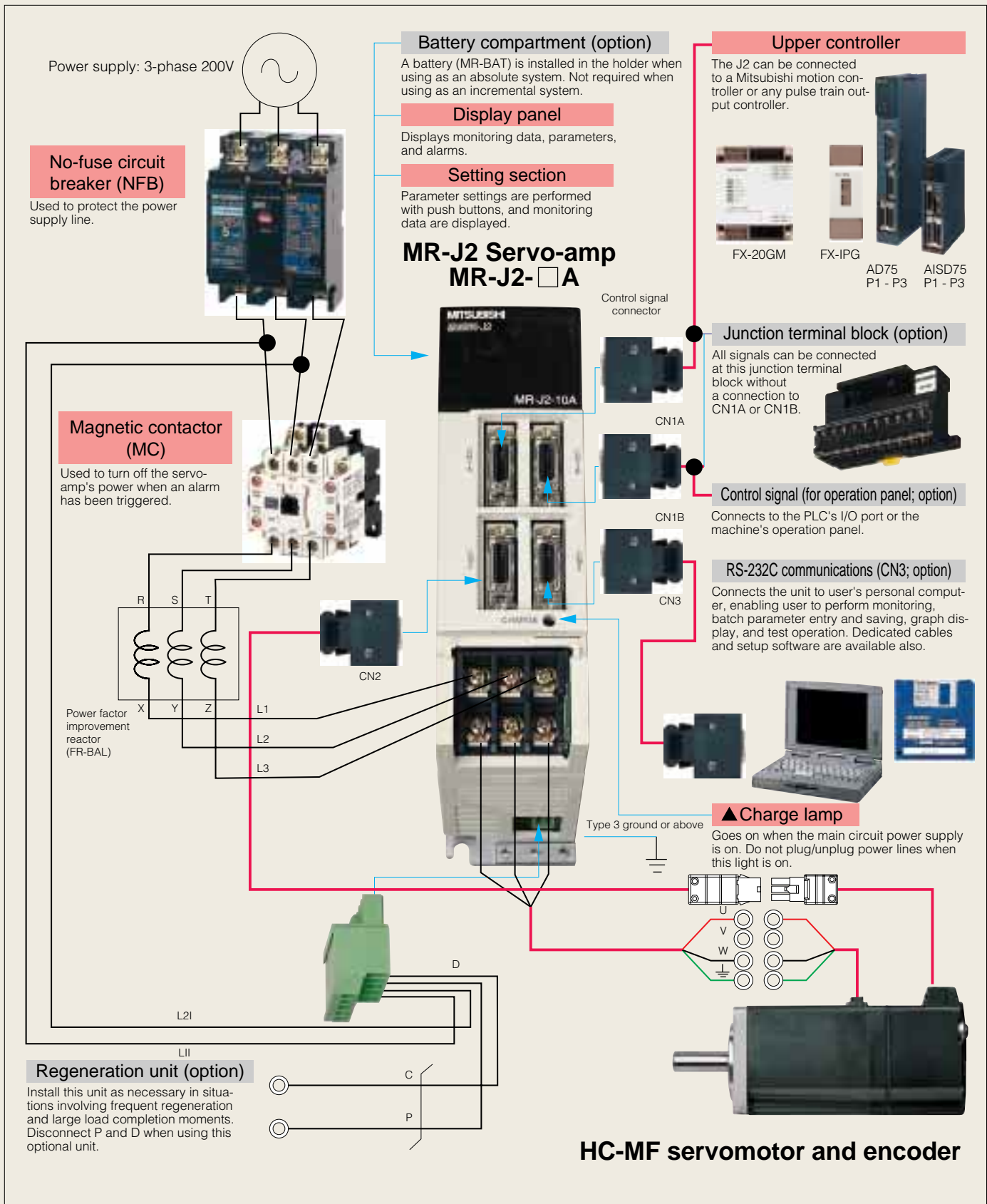

Operation

Easier to operate than ever before

The display and setting sections are easy to operate. And with the advanced features it incorporates, the J2 is easy to start up.

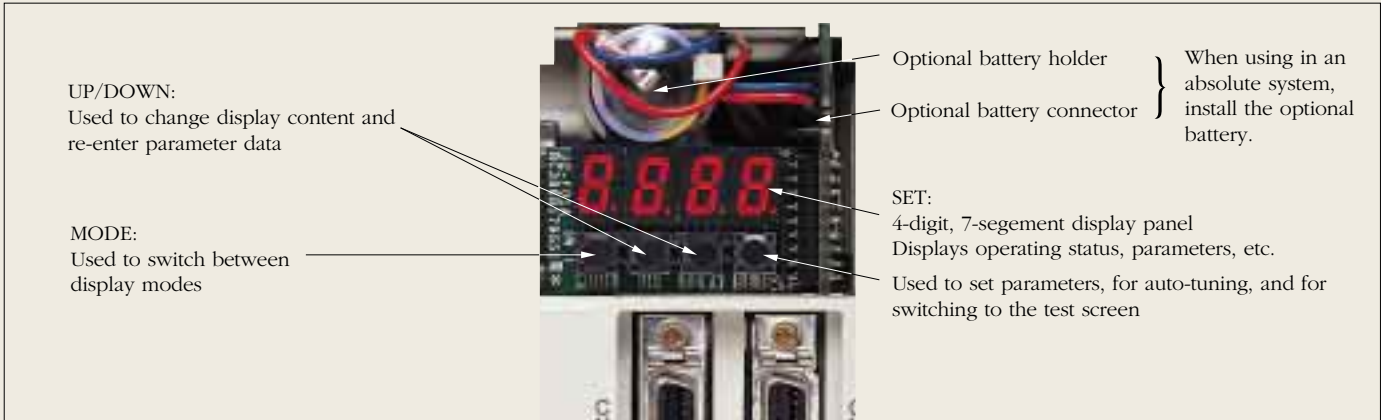

Explanation of 7-segment display device

Pressing the MODE button causes the display mode to change one step at a time in the sequence illustrated below.

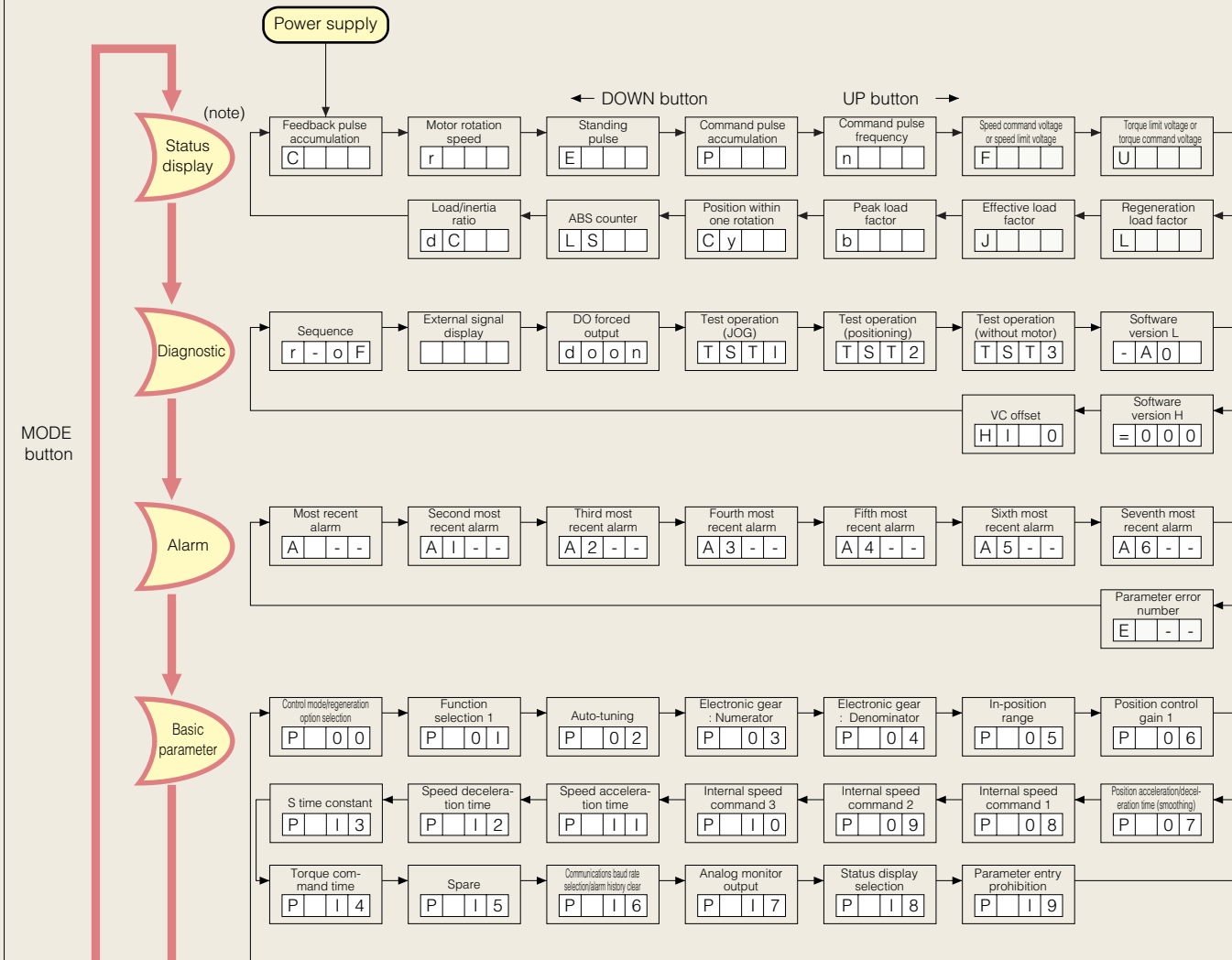

Setup and Testing

A complete lineup of features to make setup easy

User-friendly, from the way you turn on the power to how connection checks and parameter settings are performed.

Turning the power on and displaying the present status

Approximately five seconds after you turn the power on, the status display mode screen appears. You can display the desired operating parameter by pressing the UP or DOWN button.

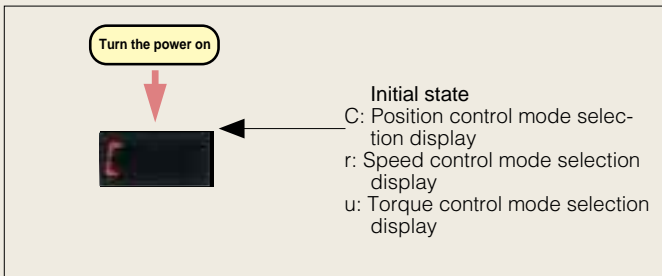

Setting parameters

Basic parameters are set as illustrated below.

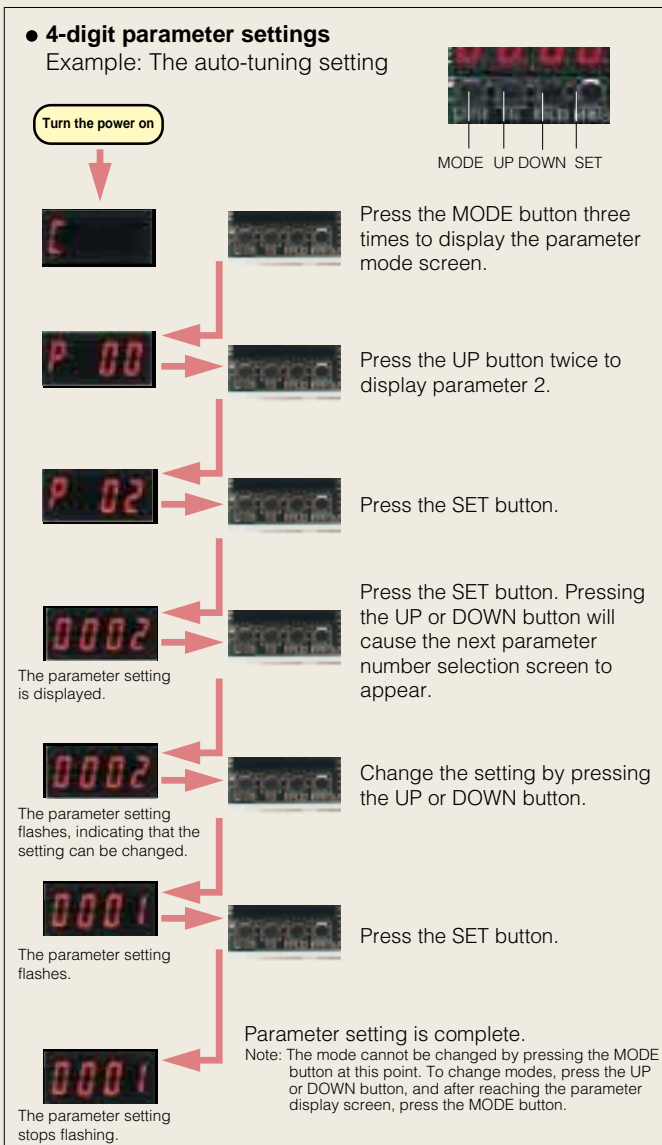

• 5-digit parameter settings

Example: Command pulse magnification numerator setting

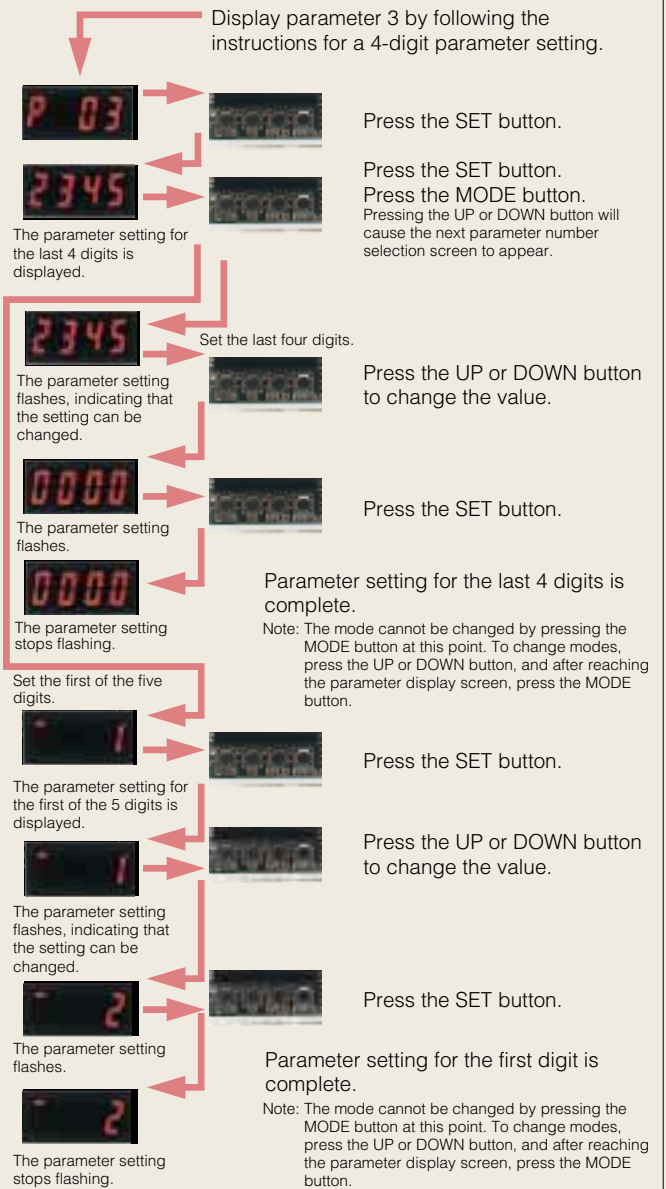

External signal display

External input/output signals' on/off status is displayed in segments. The upper portion of each segment's vertical line indicates the input signal, while the lower portion indicates the output signal.

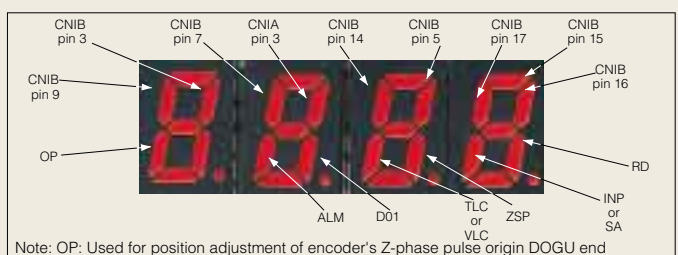

Test operation mode

The operation of the servo-amp and servomotor can be checked before wiring the signal wires.

• Test operation mode 1: Operation without commands

The motor can be operated even without speed/position commands, start signals, or other external signals. This enables users to test the servo alone, prior to the fabrication of a control panel, and to confirm the machine's operation.

(1) JOG operation

The motor will run as long as the UP or DOWN button is being pressed.

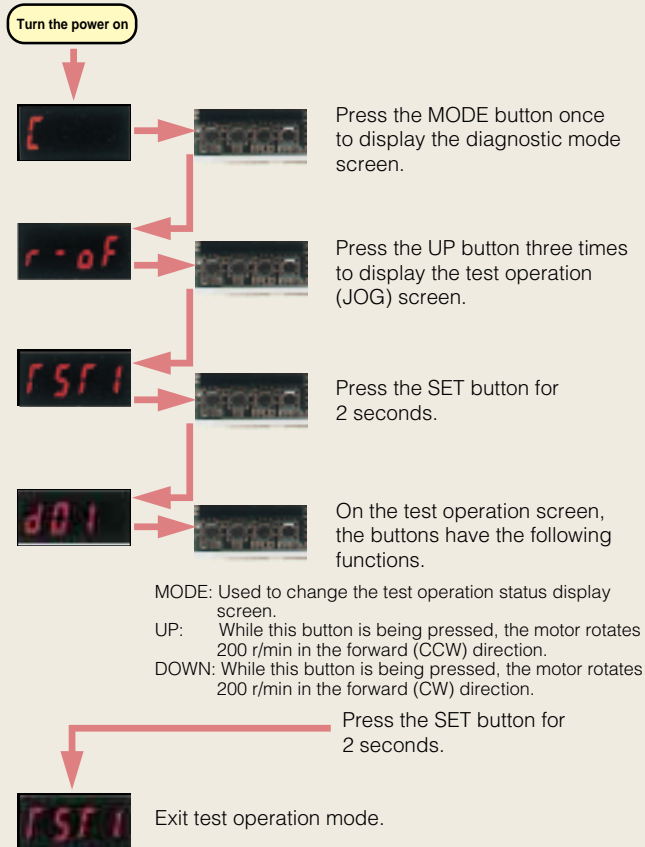

(2) Positioning operation

The motor moves just the number of pulses set and is positioned. This is an easy way to check the amount of machine movement. Positioning operation can only be performed with the setup software.

The servo-amp screen when the unit has been set to positioning operation mode with the setup software.

The servo-amp screen when the unit has been taken out of positioning operation mode with the setup software.

• Test operation mode 2: Operation without a motor

The servo amplifiers can be checked without connecting them to a motor. This is convenient when you want to confirm a command or peripheral sequence before operating the actual machine. You can monitor the motor's simulated rotation speed and command status on the amp's display screen just as you would during normal operation.

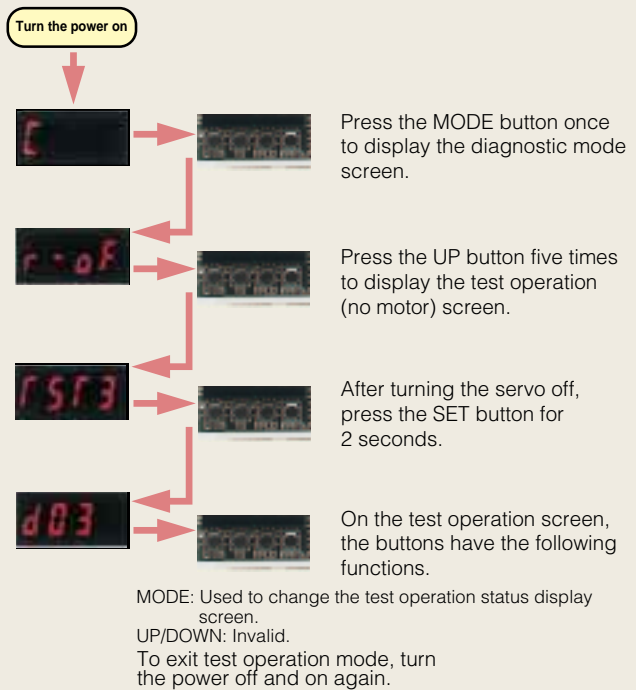

Setup and Parameters

Output signal forced output

Forcing output signals on or off, such as alarm and ready signals, makes it easy to perform external wiring and sequence checks.

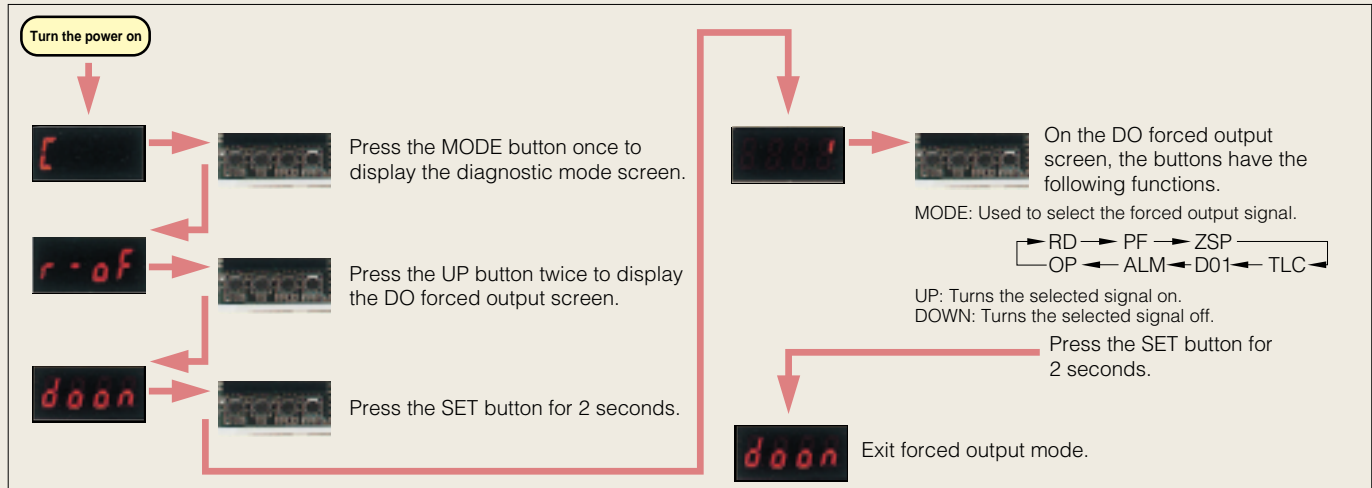

Basic parameters

The basic parameters are listed below. For parameters marked with an asterisk, turn the power off after setting and turn the power back on to complete the setting.

Parameter number	Name	Abbreviation	Description	Factory setting	Setting range
*0	Control mode/regeneration selection	STY	Used to select the control mode and regeneration option	0000	0000 ~ 0605h
*1	Function selection 1	OP1	Used to select servo-type options	0000	0000 ~ 1012h
2	Auto-tuning	ATU	Used to select the auto-tuning function	0102	0001 ~ 0215h
3	Electronic gear (command pulse magnification numerator)	CMX	Used to set the multiplier for the command pulse input	1	1 ~ 32767
4	Electronic gear (command pulse magnification denominator)	CDV	Used to set the divisor for the command pulse input	1	1 ~ 32767
5	In-position range	INP	Used to set the range for the standing pulse, which sends in-position output	100 (pulse)	0 ~ 10000
6	Position control gain 1	PG1	Used to set the model position loop gain	36 (rad/s)	4 ~ 1000
7	Position acceleration/deceleration time constant (smoothing)	PST	Used to set the time constant when using a delayed filter for the position command	3 (msec)	0 ~ 20000
8	Internal speed command 1	SC1	Used to set the first speed of the internal speed command	100 (r/min)	0 ~ permissible rotation speed
9	Internal speed command 2	SC2	Used to set the second speed of the internal speed command	500 (r/min)	0 ~ permissible rotation speed
10	Internal speed command 3	SC3	Used to set the third speed of the internal speed command	1000 (r/min)	0 ~ permissible rotation speed
11	Speed acceleration time constant	STA	Used to set the acceleration time from stop until the attainment of rated rotation speed for the speed command	0 (msec)	0 ~ 20000
12	Speed deceleration time constant	STB	Used to set the deceleration time from the rated rotation speed until stop for the speed command	0 (msec)	0 ~ 20000
13	S-time Constant	STC	Used to set the time for the circular portion of S acceleration/deceleration	0 (msec)	0 ~ 1000
14	Torque command time constant	TQC	Used to set the time constant when using a delayed filter for the torque command	0 (msec)	0 ~ 20000
15	Spare			0	
*16	Communications baud rate selection/alarm history clear	BPS	Used to set the RS-232C baud rate and to clear the alarm history	0000	0000 ~ 0011h
17	Analog monitor output	MOD	Used to make the settings related to analog monitor output	0100	0000 ~ 0A0Ah
*18	Status display selection	DMD	Used to make the settings related to status display	0000	0000 ~ 001Ch
*19	Parameter entry prohibition	BLK	Used to select the parameter reference range and entry range	0000	0000 ~ 000Ch

Servo-amp Specifications

Servo-amp model MR-J2-		10A	20A	40A	60A	70A	100A	200A	350A	101A	20A1	40A1	
Servo-amp	Power supply	Voltage/frequency (note)	3-phase 200 to 230V AC 50/60Hz								1-phase 100 to 120V AC 50/60Hz		
		Permissible voltage fluctuation	3-phase 170 to 253V AC 50/60Hz								1-phase 85 to 127V AC 50/60Hz		
		Permissible frequency fluctuation	±5% max.										
	Control system		Sinusoidal PWM control/current control system										
	Speed frequency response		250Hz or more										
	Safety features		Excess current shutdown, regeneration excess voltage shutdown, excess load shutdown (electronic thermal), servomotor overheat protection, encoder error protection, regeneration error protection, insufficient voltage/sudden power outage protection, excess speed protection, excess error protection										
	Torque limit input		0 to ±10V DC/maximum torque										
	Position control specifications	Maximum input pulse frequency	400 kpps (when using differential receiver), 200 kpps (when using open collector)										
		Positioning feedback pulse	Resolution per servomotor rotation (see "Speed/position encoder" in the servomotor specifications)										
		Command pulse multiple	Electronic gear A/B multiple; A, B: 1-32767 1/50 <A/B <50										
		Positioning complete width setting	0 to ±10000 pulses										
		Excess error	±80k pulses										
	Speed control specifications	Speed control range	External speed 1:1000, internal speed 1:5000										
		Speed command input	0 to ±10V DC/maximum speed										
		Speed fluctuation rate	-0.03% max. (load fluctuation 0 to 100%) ±0.02% max. (power fluctuation ±10%) ±0.02% max. (ambient temperature 25°C ±10°C (77°F ±50°F)), when using external analog speed										
	Torque control specifications	Torque command input	0 to ±8V DC/maximum torque										
Structure		Self-cooling, open (IP00)											
Environment	Ambient temperature	0 to 55°C (32 to 131°F) (non freezing), storage: -20 to 65°C (-4 to 149°F) (non freezing)											
	Ambient humidity	90% RH max. (non condensing), storage: 90% RH max. (non condensing)											
	Atmosphere	Inside control panel; no corrosive gas, flammable gas, oil mist, or dust											
	Elevation	1000 meters or less above sea level											
	Oscillation	5.9 m/s ² (0.6G) max.											
Weight	kg (lb)	0.7 (1.5)	0.7 (1.5)	1.1 (2.4)	1.1 (2.4)	1.7 (3.7)	1.7 (3.7)	2.0 (4.4)	2.0 (4.4)	0.7 (1.5)	0.7 (1.5)	1.1 (2.4)	

Note: Rated output capacity and rated rotation speed of the servomotor used in combination with the servo-amp are as indicated when using the power voltage and frequency listed. Output and speed cannot be guaranteed when the power supply's voltage is less than specified.

Signal Terminal Descriptions

● Terminal block

Signal	Abbreviation	Terminal	Description of function/application
Alternating circuit power supply	L1, L2, L3	TE1	Connect to a 3-phase 200-230V 50/60Hz commercial power supply. There are no phase sequence limitations.
	L11, L21	TE2	Connect to a single-phase 200-230 V 50/60 Hz commercial power supply. Supply power from the same source as that for L1, L2, and L3. Turn on before or simultaneously with L1, L2, and L3. Turn off simultaneously with or after L1, L2, and L3.
Motor output	U, V, W	TE1	Connect to the U, V, and W terminals of the motor's power supply. The motor will not rotate properly if an error is made in the phase sequence.
Regeneration brake resistor	P, C, D	TE2	When using the optional regeneration unit, remove the wires connecting P and D, and connect the optional regeneration unit between P and C.
Ground	PE	Chassis	Ground with the motor at one point. Connected to the chassis.

● Connector CN1A (Factory settings)

Same for position, speed, and torque control modes

Signal	Abbreviation	Connector number	Description of function/application	I/O category
Digital interface power input	Vin	9	Driver's power input terminal for digital interface. Vin are all connected inside. Supply 24 V DC power to this terminal when using an external power supply.	Power supply
Digital interface common	SG	10,20	24 V common, insulated from LG	Common
15 V DC power output	P15R	4	15 V power supply. Maximum permissible current is 30 mA.	Power output
Control common	LG	1	Control signal common terminal	
Encoder A-phase pulse	LA	6	Encoder's A-/B-phase pulse signal output terminal. Differential line driver output. Output pulse can be changed through the parameter setting.	DO-2
	LAR	16		
Encoder B-phase pulse	LB	7		
	LBR	17		
Encoder 2-phase pulse	LZ	5	Encoder's Z-phase pulse signal output terminal. One pulse is output for each motor rotation. Minimum pulse width is 400 μ s. Set speed to 100 r/min or less when using this pulse. LZ/LZR is differential line driver output; OP is open collector output.	
	LZR	15		
	OP	14		
Ready	RD	19	Ready signal output terminal. RD and SG are connected after the servo is turned on when there are no malfunctions and the unit is operable.	DO-1
Shield	SD	Plate	Connect one end of the shield wire.	

Position control mode

Open collector power input	OPC	11	Open collector power input terminal. Connect this terminal to VDD when inputting pulse train in open collector mode. Supply 24 V DC power to this terminal when using an external power supply.	Power input
Forward pulse train	PP	3	Forward pulse train signal input terminal. Compatible with both open collector and differential modes. Connect PP and SG when using open collector mode.	DI-2
	PG	13		
Reverse pulse train	NP	2	Reverse pulse train signal input terminal. Compatible with both open collector and differential modes. Connect NP and SG when using open collector mode.	DI-2
	NG	12		
Clear	CR	8	Clear signal input terminal. Short circuiting CR and SG will cause the number of drop pulses (position error) to be cleared at startup. Level clear can be chosen through the parameter settings. With the ABS method, when the number of drop pulses (position error) is cleared, origin data is simultaneously set in nonvolatile memory.	DI-1
Positioning complete	INP	18	Positioning-complete signal output terminal. Connection between INP and SG is made when the standing pulse is smaller than the parameter-set in-position range. Not output when the base is turned off.	DO-1

Speed control mode

Speed selection 1	SP1	8	Speed selection 1 signal input terminal. Runs at parameter-set speed.	DI-1
Speed attained	SA	18	Speed attained signal output terminal. When the motor rotation speed exceeds the command speed range of ± 20 r/min, the connection between SA and SG is made. Not output when the base or start signal is turned off.	DO-1

Torque control mode

Speed selection 1	SP1	8	Speed limit selection 1 signal input terminal. Runs within the limitations of the parameter-set speed when SPI and SG are short circuited.	DI-1
-------------------	-----	---	--	------

● Connector CN3 (Factory settings)

Same for position, speed, and torque control modes

Signal	Abbreviation	Connector number	Description of function/application	I/O category
Monitor output	MO1	4	Monitor output signal terminal. Analog output of the parameter-set data.	Analog output
	MO2	14		
Monitor common	LG	3,13	Control common is used for monitor common.	Analog common
Shield	SD	Plate	Connect one end of shield wire.	

Signal Terminal Descriptions

● Connector CN1B (Factory settings)

Same for position (ABS method), speed, and torque control modes

Signal	Abbreviation	Connector number	Description of function/application	I/O category
Digital interface power input	Vin	13	Driver's power output terminal for digital interface. Supply power for the digital input/output signal (DI-I, DO-I) from external power supply: VDD or 24 V DC power.	Power supply
Internal power supply output for interface	VDD	3	Driver's power output terminal for digital interface. Outputs +24 V \pm 10% between 24 V commons. Connect to Vin when not using an external power supply. Do not allow the sum of current for the command unit and input/output relay drive to exceed 80 mA.	
Digital interface common	SG	10,20	24V common, insulated from LG	Common
15 V DC power output	P15R	11	15V power supply. Maximum permissible current is 30 mA.	Power supply
Control common	LG	1	Control signal common terminal	Analog common
External emergency stop	EMG	15	Emergency stop signal input terminal. Disconnecting EMG and SG puts the unit in emergency stop state; power to the base is cut off and the dynamic brake is activated. Short circuiting EMG and SG in the emergency stop state causes the unit to automatically exit the emergency stop state.	DI-1
Servo on	SON	5	Preparation for operation signal input terminal. Short circuiting SON and SG places the unit in an operable state. Disconnecting these terminals causes power to the base to be cut off and the servomotor to enter a free running condition. This can be set to automatic on with the parameter settings.	DI-1
Reset	RES	14	Alarm reset signal input terminal. Short circuiting RES and SG causes the malfunction to be reset. While the alarm is being reset, power to the base is cut off. Malfunctions related to regeneration errors and overloading cannot be reset with the alarm reset signal immediately after their occurrence.	DI-1
Malfunction output	ALM	18	Malfunction signal output terminal. When the power is turned off the protective circuit is activated, and when power to the base is cut off, the ALM-SG connection cannot be made. If everything is normal when the power is turned on, the connection is made. Configure a sequence for cutting off the input MC when a malfunction occurs.	DO-1
Zero speed detection (ABS data bit 1)	ZSP (ABS bit1)	19	Zero speed signal output terminal. When the motor rotation speed is less than the speed set in the zero speed parameter setting, the connection between ZSP and SG is made. (ABS data bit 1 signal output terminal. The upper bit of the two-bit data is forwarded to the command unit from the servo-amp.)	DO-1
Shield	SD	Plate	Connect to one end of the shield wire.	

Same for position (ABS method) and speed control modes

Analog limit	TLA	12	Analog torque limit signal input terminal. Input an external analog torque limit. (0- \pm 10 V/maximum torque)	Analog input
Torque limit in effect (forwarding data being prepared)	TLC (ABS busy)	6	Torque limit in effect signal output terminal. When the set torque limit is reached, the connection between TLC and SG is made. Not output when the base is turned off. (Forwarding data being prepared signal output terminal. Indicates that forwarding data is being prepared.)	DO-1
Forward stroke end	LSP	16	Forward/reverse stroke end signal input terminal. Disconnecting LSP and SG makes the unit inoperable in a CCW direction, but operable in a CW direction. To operate in a CCW direction, connect between LSP and SG with a limit switch. Disconnecting LSN and SG makes the unit inoperable in a CW direction, but operable in a CCW direction. To operate in a CW direction, circuit between LSN and SG with a limit switch. This can be set to go on automatically with the parameter settings.	DI-1
Reverse stroke end	LSN	17		

Position control mode (ABS method)

Proportional control (ABS forwarding mode)	PC(ABSM)	8	Proportional control signal input terminal. Connect between PC and SG when you want to suppress microvibrations when the servo lock is on. (ABS forwarding mode signal input terminal. Connecting ABSM and SG puts the unit in ABS forwarding mode.)	DI-1
External torque limit (ABS data request)	TL(ABSR)	9	External torque limit signal input terminal. Connecting TL and SG limits the torque to the TLA level. (ABS data request signal input terminal. Connecting ABSR and SG generates a request for ABS data.)	DI-1
Proportional control (ABS data bit 0)	ABS bit0	4	ABS data bit0 signal output terminal. The lower bit of the two-bit data forwarded to the command unit from the servo-amp.	DO-1

Speed control mode

Speed selection 2	SP2	7	Speed selection 2 signal input terminal. Runs at parameter-set speed.	DI-1
Forward start	ST1	8	Forward start signal input terminal. Connecting ST1 and SG causes the motor to rotate in a CCW direction.	DI-1
Forward start	ST2	9	Reverse start signal input terminal. Connecting ST2 and SG causes the motor to rotate in a CW direction. Simultaneously connecting or disconnecting ST1 and ST2 causes the motor to decelerate and stop, the position control to fall below zero speed, and the servo to enter a locked state.	DI-1
Analog speed command	VC	2	Analog speed command signal input terminal. Input an external analog speed command. (0- \pm 10 V/maximum rotation speed)	Analog input

Torque control mode

Speed selection 2	SP2	7	Speed selection 2 signal input terminal. Connecting SP2 and SG limits operation to the parameter-set speed.	DI-1
Reverse selection	ST1	8	Reverse power torque generation signal input terminal. Select the direction of the torque to be generated. Connecting ST1 and SG causes torque to be generated in reverse power/forward regeneration direction.	DI-1
Forward selection	ST2	9	Forward power torque generation signal input terminal. Select the direction of the torque to be generated. Connecting ST2 and SG causes torque to be generated in forward power/reverse regeneration direction.	DI-1
Analog speed limit	VLA	2	Analog speed command signal input terminal. Input an external analog speed limit.	Analog input
Speed limit in effect	VLC	6	Speed limit signal output terminal. When the set torque limit is reached, the connection between VLC and SG is made. Not output when the base is turned off.	DO-1
Analog torque command	TC	12	Analog torque command signal input terminal. Input an external analog torque command. (0- \pm 8 V/maximum torque)	Analog input

Amplifier Dimensions

Unit: mm (inch)

● MR-J2-10A1, 20A1, 10A/B/C, 20A/B/C

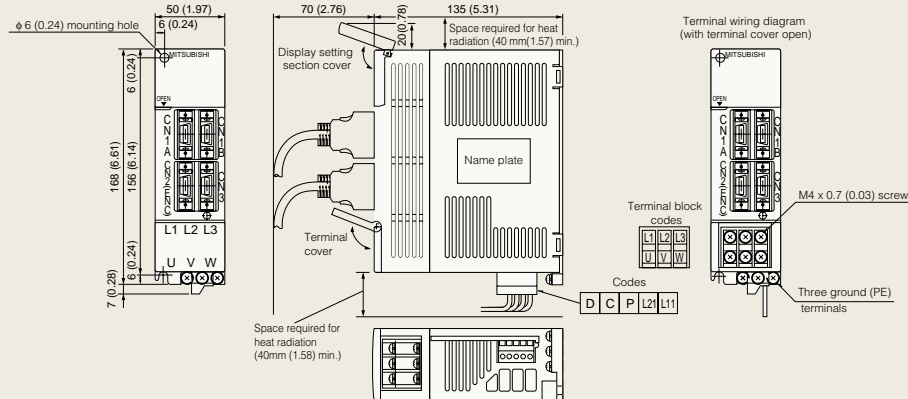

● MR-J2-40A1, 40A/B/C, 60A/B/C

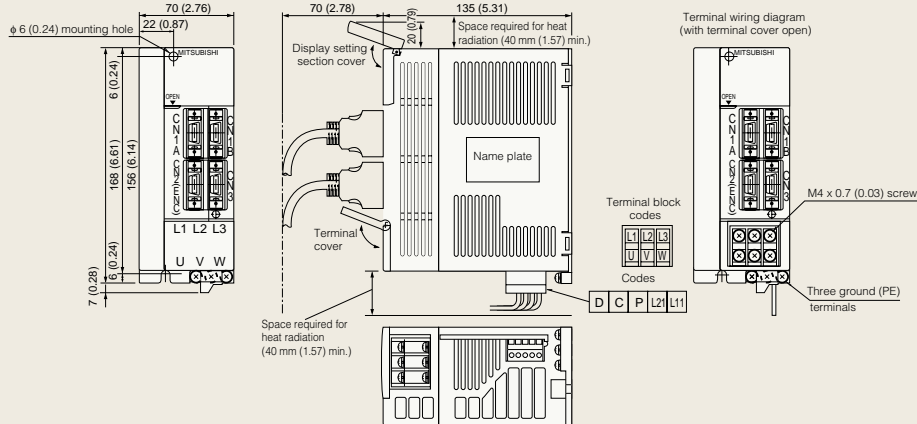

● MR-J2-70A/B/C, 100A/B/C

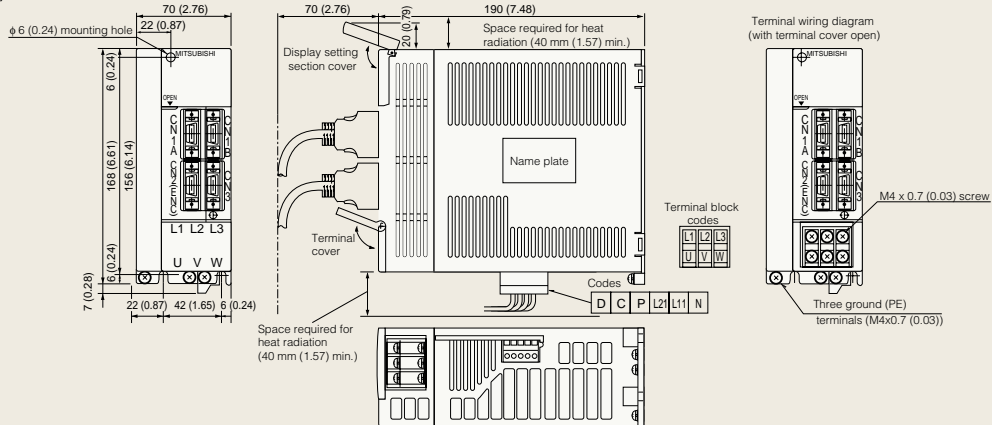

● MR-J2-200A/B/C, 350A/B/C

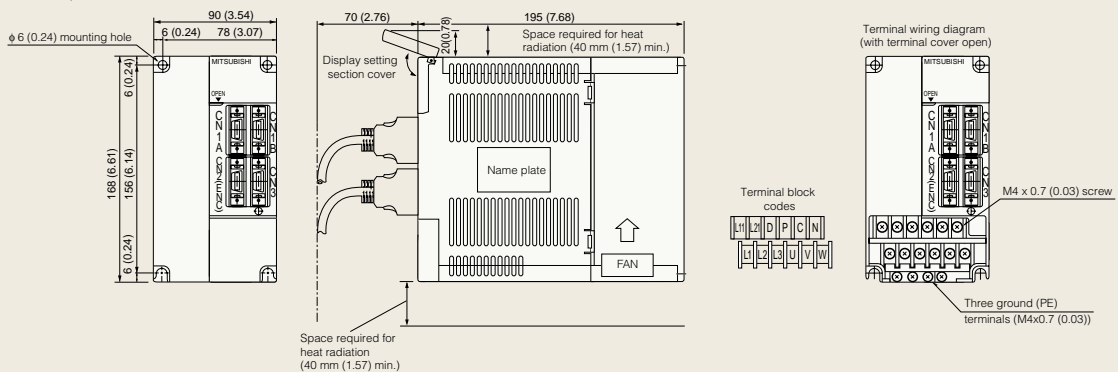

Standard Wiring Diagram

Position control operation

● Connection to AD75P□/A1SD75P□ (position servo, incremental)

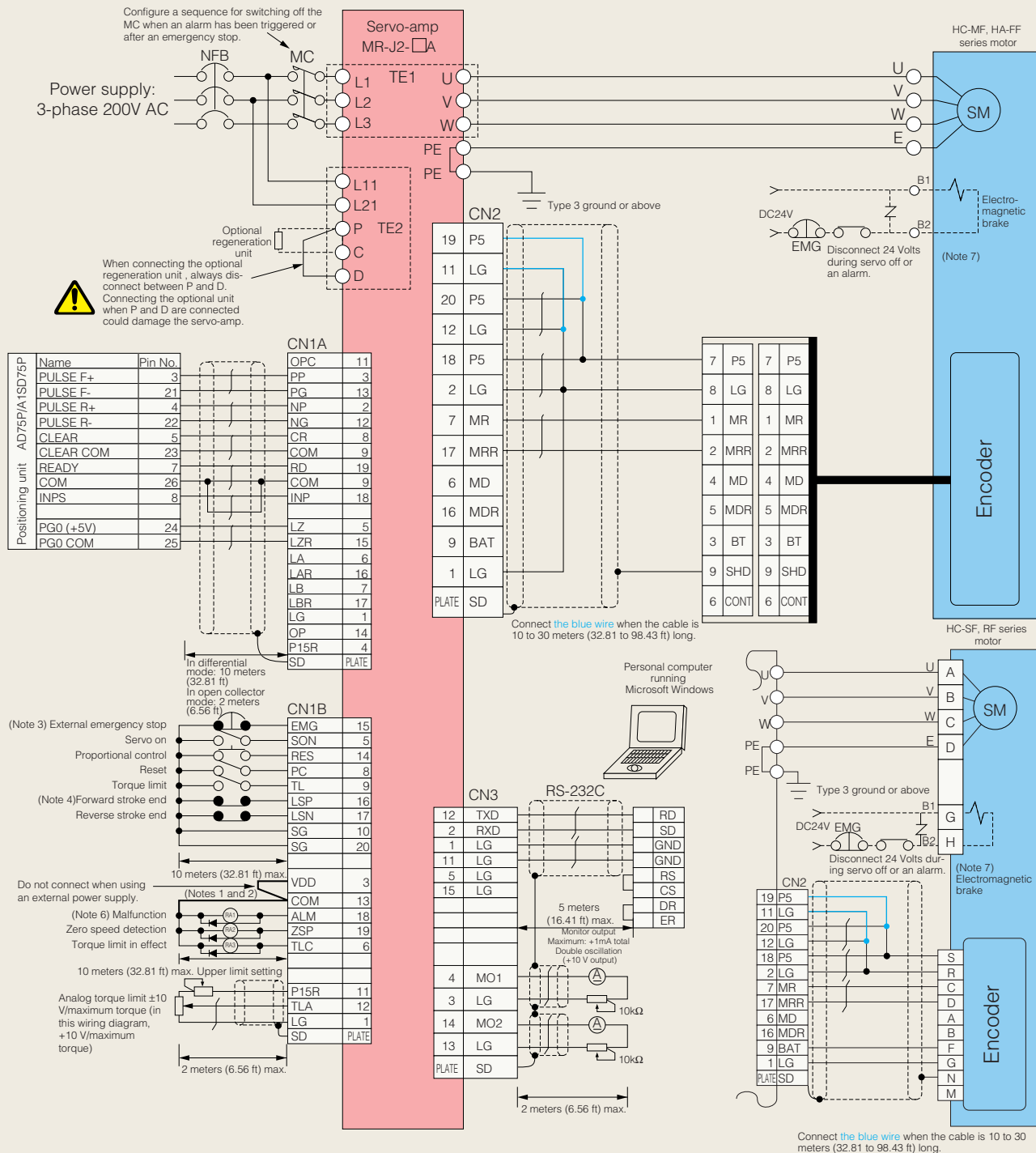

Notes:

- Do not reverse the diode's direction. Connecting it backwards could cause the amp to malfunction so that signals are not output and emergency stop and other safety circuits are inoperable.
- Make sure that the sum of current flowing to external relays does not exceed 80 mA. If it exceeds 80 mA, supply interface power from an external source.
- Always connect an EMG external emergency stop. (b contact) The unit cannot be operated unless one is connected.
- Provide normally closed inputs for LSP, LSN.
- Signals with the same name are connected inside.
- Malfunction (ALM) signals are turned on during normal operation when no alarms have been triggered.
- When using a motor with electromagnetic brake. Polarity of power supply connected to electromagnetic brake's lead (compressed terminals' sleeve is blue) is unimportant.
- Connect shield wire securely to plate inside the connector (ground plate).
- Connect between LG and pulse output COM to strengthen noise.
- Always use a shielded multicore cable; up to a maximum of 15 meters is possible in a good noise environment.

Standard Wiring Diagram

● Connection to AD75P□/A1SD75P□ (position servo, absolute)

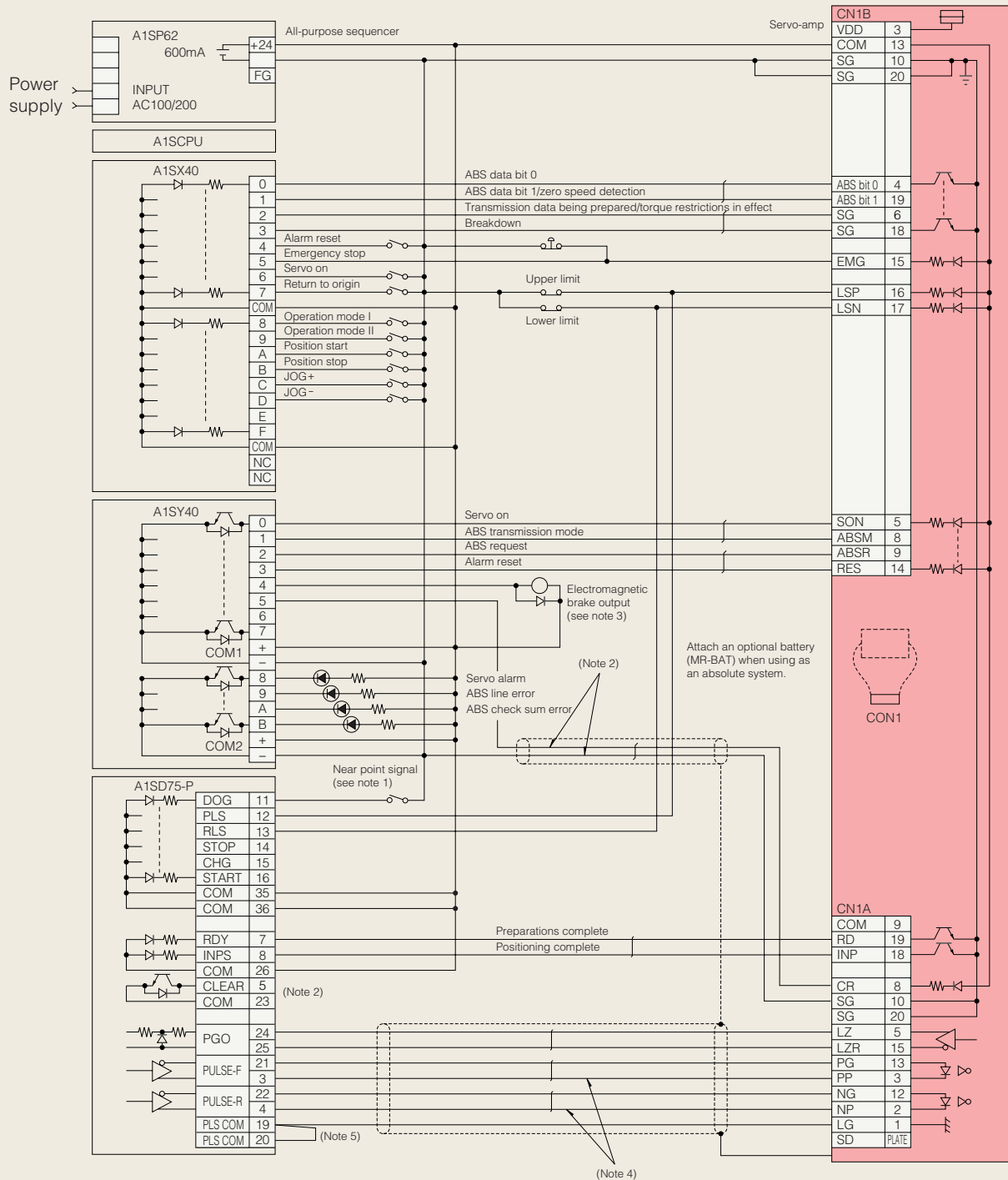

Standard Wiring Diagram

Speed control operation

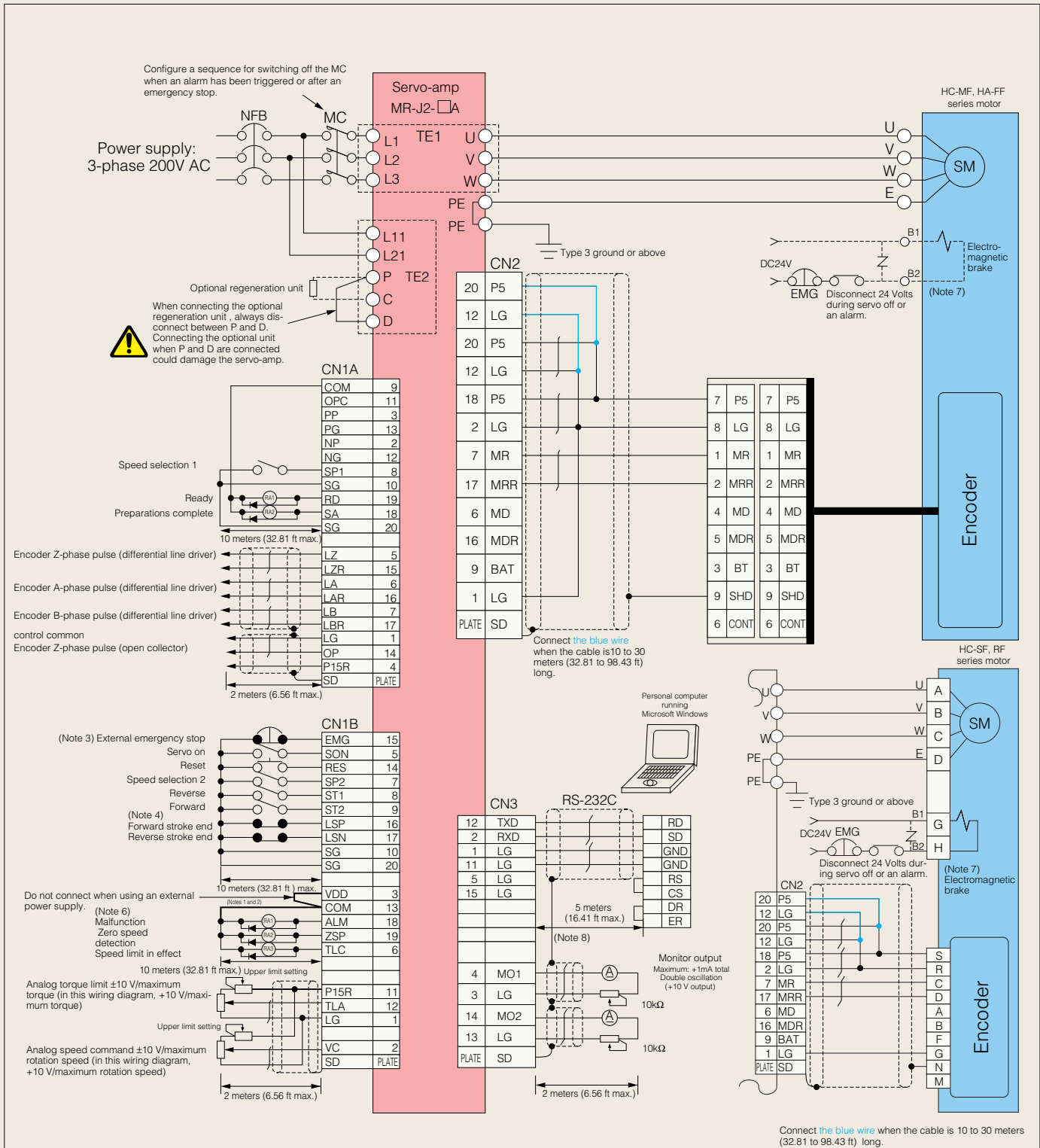

Standard Wiring Diagram

Torque control operation

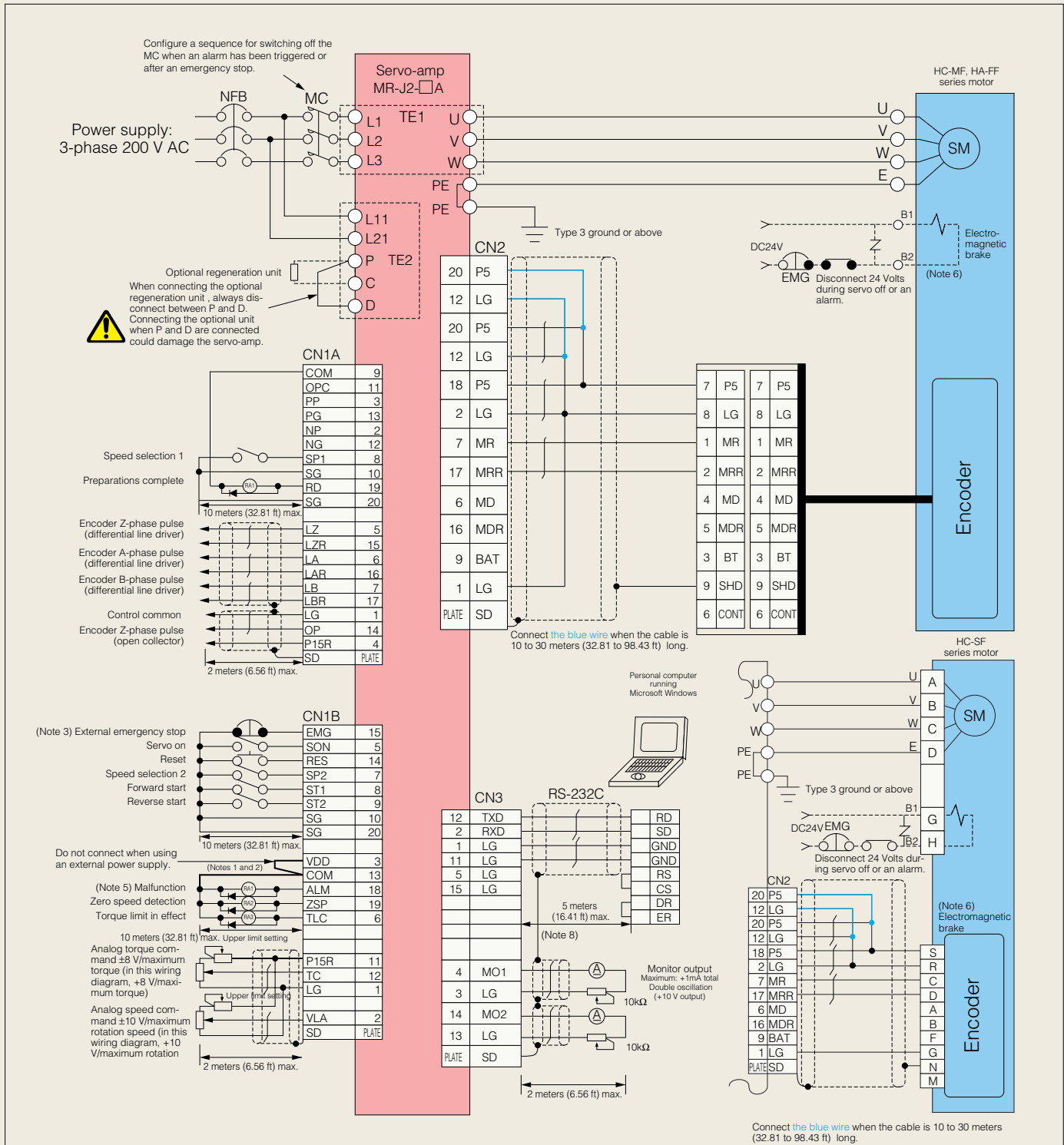

Interfaces

Digital input interface DI-1

Supply signal with a miniature relay or an open collector transistor (TR).

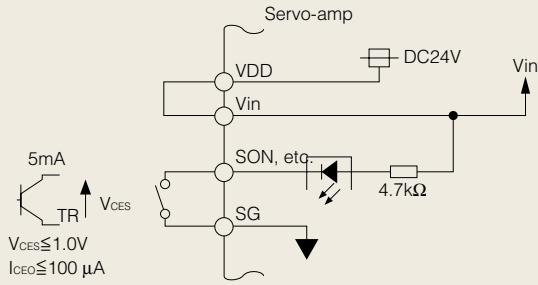

Digital output interface DO-1

Can drive a lamp, relay, or photocoupler.

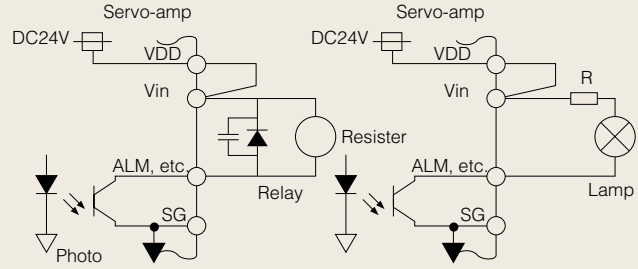

Note: For an induction load install a surge suppressor (DC) ; for a lamp load install an incoming current suppression resistor (R).

Pulse train input interface DI-2

●Differential mode

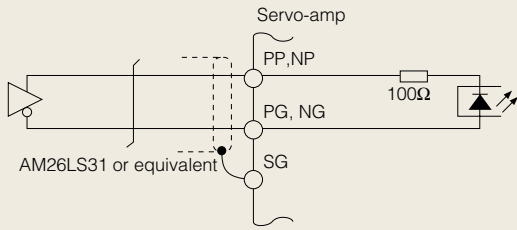

●Open collector mode

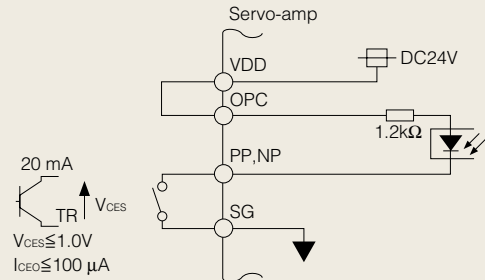

Encoder pulse train input interface DO-2

●Differential mode

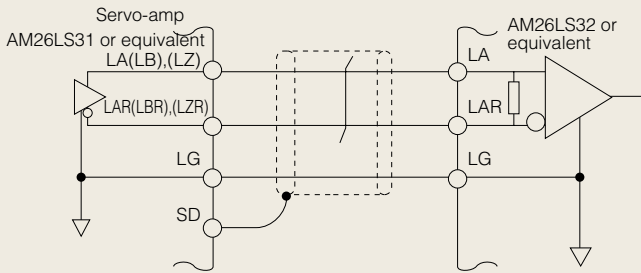

●Open collector mode

Output electric current Max.35mA

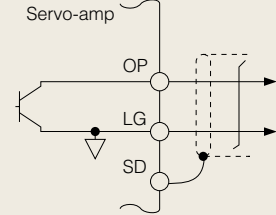

Analog input interface

Speed command (VC), torque limit command (TLA)
Servo-amp

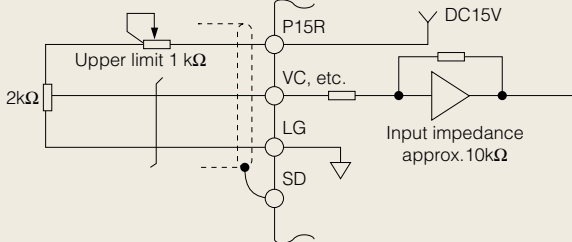

Analog output interface

Servo-amp
Output: ±10 V Full scale
Max.1mA

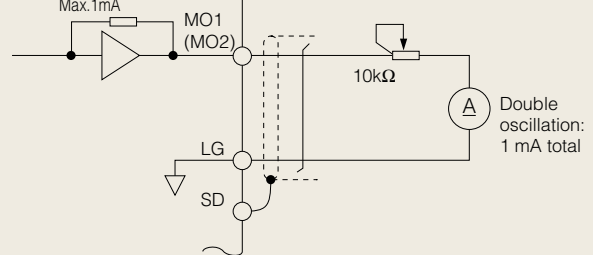

Safety Features

The J2 servo-amp possesses the safety features described below. To protect the unit, when a safety circuit is activated output is suspended by cutting off power to the transistor base. When this happens, the dynamic brake is activated and stops the motor. An alarm number is displayed on the servo-amp or personal computer. After eliminating the cause, close the reset terminal (RES) or turn off the control power and reset.

	Alarm LED display	Safety feature name	Description
Alarm	A.10	Insufficient voltage	Is activated when the power supply's voltage falls below a certain level or when a sudden power outage of more than 15 milliseconds occurs.
	A.11	Board error 1	Is activated when an error is detected in the printed board.
	A.12	Memory error 1	Is activated when an error is detected in the printed board's memory.
	A.13	Clock error	Is activated when an error is detected in the printed board.
	A.15	Memory error 2	Is activated when an error is detected in the printed board's memory.
	A.16	Encoder error 1	Is activated when a different type of encoder is detected and communication with encoder cannot be performed normally.
	A.17	Board error 2	Is activated when an error is detected in a servo-amp board component.
	A.18	Board error 3	Is activated when an error is detected in the printed board.
	A.20	Encoder error 2	Is activated when an error is detected in the encoder or encoder cable.
	A.24	Motor output ground fault	Activates when servo-amp servomotor output produces a ground fault.
	A.25	ABS data loss	Is activated when the battery's voltage falls and absolute data is lost.
	A.30	Regeneration error	Is activated when an error is detected in the regeneration circuit or when there is an excess load on the regeneration brake resistor due to excess regeneration frequency.
	A.31	Excess speed	Is activated when the motor rotation speed is detected to have exceeded the permissible rotation speed.
	A.32	Excess current	Is activated when excess current is detected.
	A.33	Excess voltage	Is activated when excess converter voltage is detected.
	A.35	Command pulse error	Is activated when an excess frequency command pulse is input.
	A.37	Parameter error	Is activated when parameters are detected to be outside the setting range through a parameter check performed when the power is turned on.
	A.46	Motor overheat	Is activated when activation, due to motor overheating, of the thermal protector inside the encoder is detected.
	A.50	Overload 1	Is activated when an overload is detected in the motor or servo-amp.
	A.51	Overload 2	Is activated when an overload is detected in the motor or servo-amp.
A.52	Excess error	Is activated when the difference between the input pulse and return pulse is detected to have exceeded 80k pulses when operating in position control mode.	
A.8E	RS-232C communications error	Is activated when an error occurs in RS-232C communications.	
Warning	A.92	Battery disconnection error	Is activated when the battery wire connected to the encoder becomes disconnected or when the battery's voltage falls.
	A.96	Origin set error	Is activated when the origin is not set following the input of a CR (clear) signal in an absolute system.
	A.9F	Battery warning	Is activated when the battery's voltage falls.
	A.E0	Excess regeneration warning	Is activated when the regeneration resistor's load reaches 85% of the alarm level.
	A.E1	Overload warning	Is activated when the unit reaches 85% of the overload alarm level.
	A.E3	ABS data counter warning	Is activated when there is an error in the absolute data counter's backup data.
	A.E5	ABS time-out warning	Is activated when there is a time-out error during the forwarding of absolute data.
	A.E6	Servo emergency stop	Is activated when an external emergency stop signal has been lifted.
	A.E9	Main circuit off warning	Is activated when the main circuit's voltage (P-N) is below 215 V when the servo on (SON) signal is turned on.
	A.EA	ABS servo on warning	Is activated when the servo on signal does not go on within 1 second after ABS forwarding mode (D13) is turned on.
	8888	System error (watchdog)	Is activated when a system error is detected.

Notes:

1. The state under which regeneration error (alarm A30) and overload 1 and 2 (alarms A50 and A51) were activated is maintained inside the servo-amp after the safety circuit is activated. Memory contents are cleared when the control voltage is turned off, but maintained by turning the RES terminal on.
2. Resetting the unit repeatedly by turning the control power supply off and on after alarms A30, A50, and A51 have been triggered can damage the components through overheating. Resume operation after definitely eliminating the cause of the alarm.
3. When an alarm has been triggered, the details can be output in 3-bit data. This depends on the setting of parameter 50.

SERVO AMPLIFIERS MELSERVO J2-B

For use with
the High Speed
“SSC-Net Bus”.

Single Touch Connection with “SSC-Net”
(High Speed Bus Connection)
results in reduced wiring.
Monitoring of status, interpolation,
synchronous control etc.
is simply performed with
the SSC-Net Controller.



Peripheral Equipment

Peripheral equipment is connected to the MR-J2-B unit as described below.

Connectors, cables, options, and other necessary equipment are available so that users can set up the MR-J2-B easily and begin using it right away. Through its SSC-NET-compatible one-touch connections, the MELSERVO-J2-B series reduces the number of wires and the chances of wiring errors.



The SSC-NET command unit is shown at left. Choose the unit that fits the size of your system.

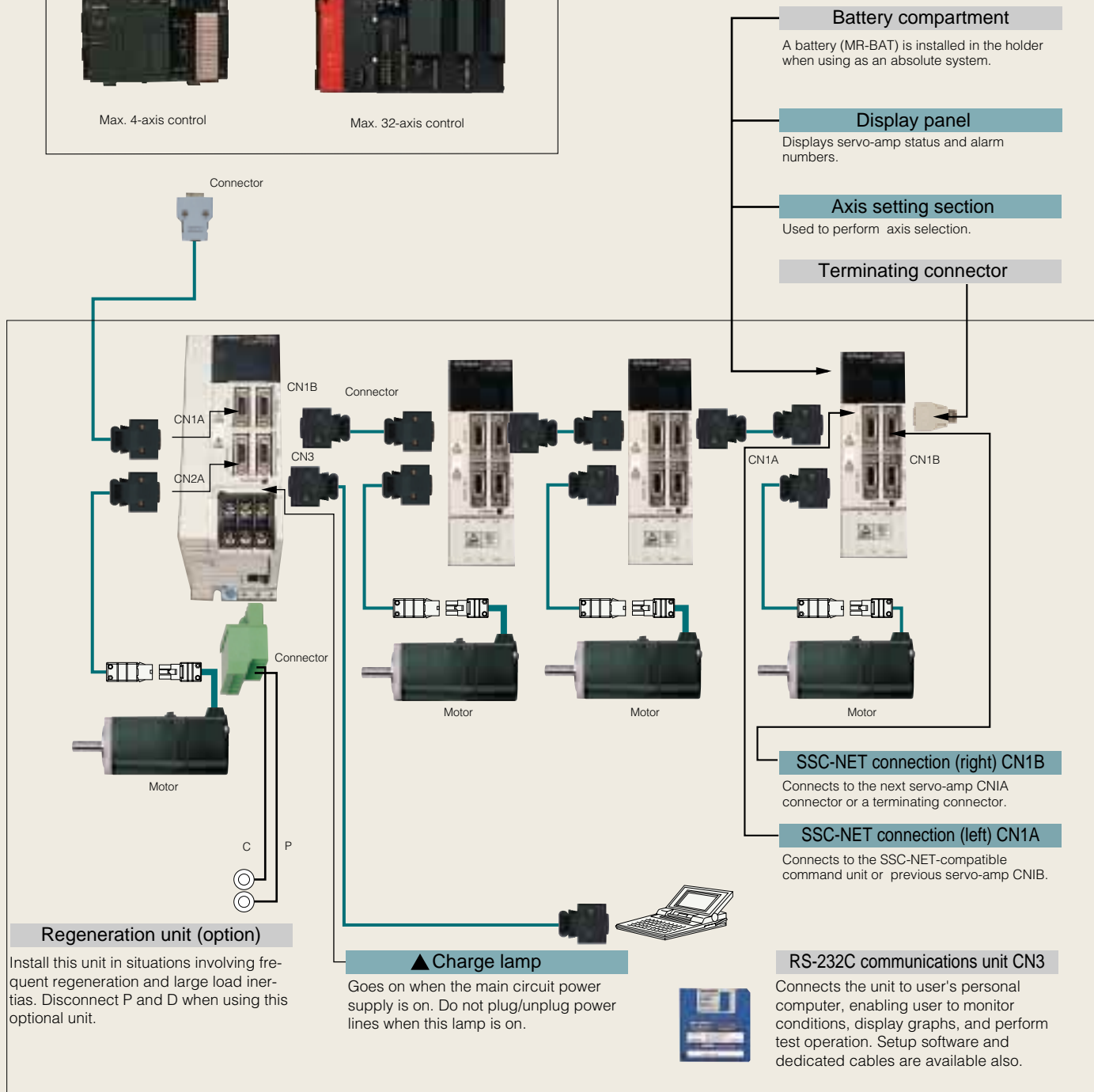

Setting and Two-Segment Display

Simple operation by setting the axis number with the axis selection switch

Simply connect the SSC-NET cable in one simple motion. No troublesome wiring or setting. The SSC-NET-compatible command unit takes care of all the parameter settings, etc.

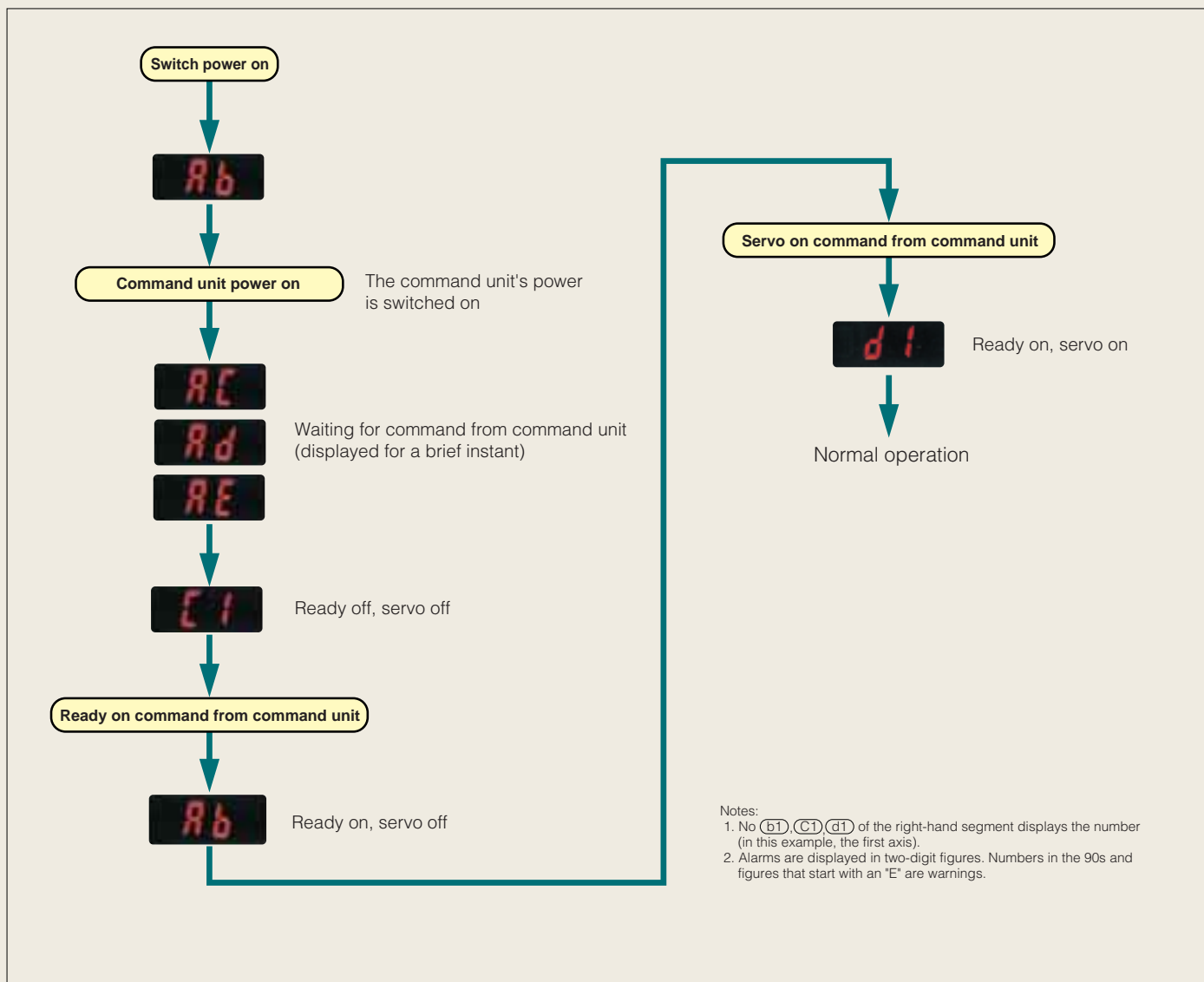
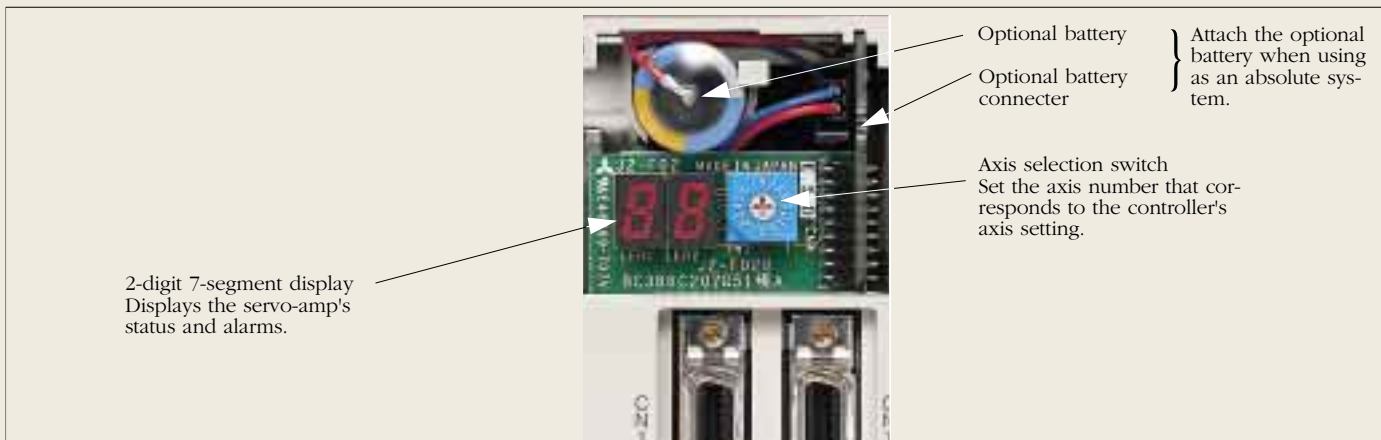

Specifications and Display Messages

Servo-amp specifications

Servo-amp model		MR-J2-	10B	20B	40B	60B	70B	100B	200B	350B	
Servo-amp	Power supply	Voltage/frequency (note)	3-phase 200 to 230V AC 50/60 Hz								
		Permissible voltage range	3-phase 170 to 253V AC								
		Permissible frequency fluctuation	±5% max.								
	Control system		Sinusoidal PWM control/current control system								
	Dynamic brake		Built-in								
	Speed frequency response		250Hz min.								
	Safety features		Excess current shutdown, regeneration excess voltage shutdown, excess load shutdown (electronic thermal), servomotor overheat protection, encoder error protection, regeneration error encoder, insufficient voltage/sudden power outage protection, excess speed protection, large error protection								
	Environment	Ambient temperature	0 to 55°C (32 to 131°F) (non freezing), storage: -20 to 65°C (-4 to 149°F) (non freezing)								
		Ambient humidity	90% RH max. (non condensing), storage: 90% RH max. (non condensing)								
		Atmosphere	Inside control panel; no corrosive gas, flammable gas, oil mist, or dust								
Elevation		1000 meters or less above sea level									
	Vibration	5.9 m/s ² (0.6G) max.									
Weight	kg (lb)	0.7 (1.5)	0.7 (1.5)	1.1 (2.4)	1.1 (2.4)	1.7 (3.7)	1.7 (3.7)	2.0 (4.4)	2.0 (4.4)		

Note: Rated output capacity and rated rotation speed of the servomotor used in combination with the servo-amp are as indicated when using the power voltage and frequency listed. Output and speed cannot be guaranteed when the power supply's voltage drops.

Explanation of display messages

The servo's status is displayed on the seven segments on the front of the servo-amp. Alarm numbers are displayed here also when an alarm has been triggered.

Display	Description
AA	Initializing, waiting for motion controller power to switch on (when motion controller power has been switched off)
Rb	Initializing, waiting for motion controller power to switch on (when motion controller power is off because the amp's power has been switched on)
AC	Initializing, between motion controller and amp begins communicating
Rd	Initializing, initial parameter reception complete
AE	Initialization completed
b#	Ready off
C#	Initialization completed, Servo off, controller side servo off. Issuing command.
d#	Servo on
E*	Warning
**	Alarm
..	CPU error
⊛	Decimal point flashes. Test operation mode

Note: #: Axis number (1 to 8: Axis numbers, 0: test operation)

Amp dimensions

Same as MR-J2-A: Refer to diagram for A series.

Standard Wiring Diagram and Terminal Descriptions

Serial bus version (available soon)

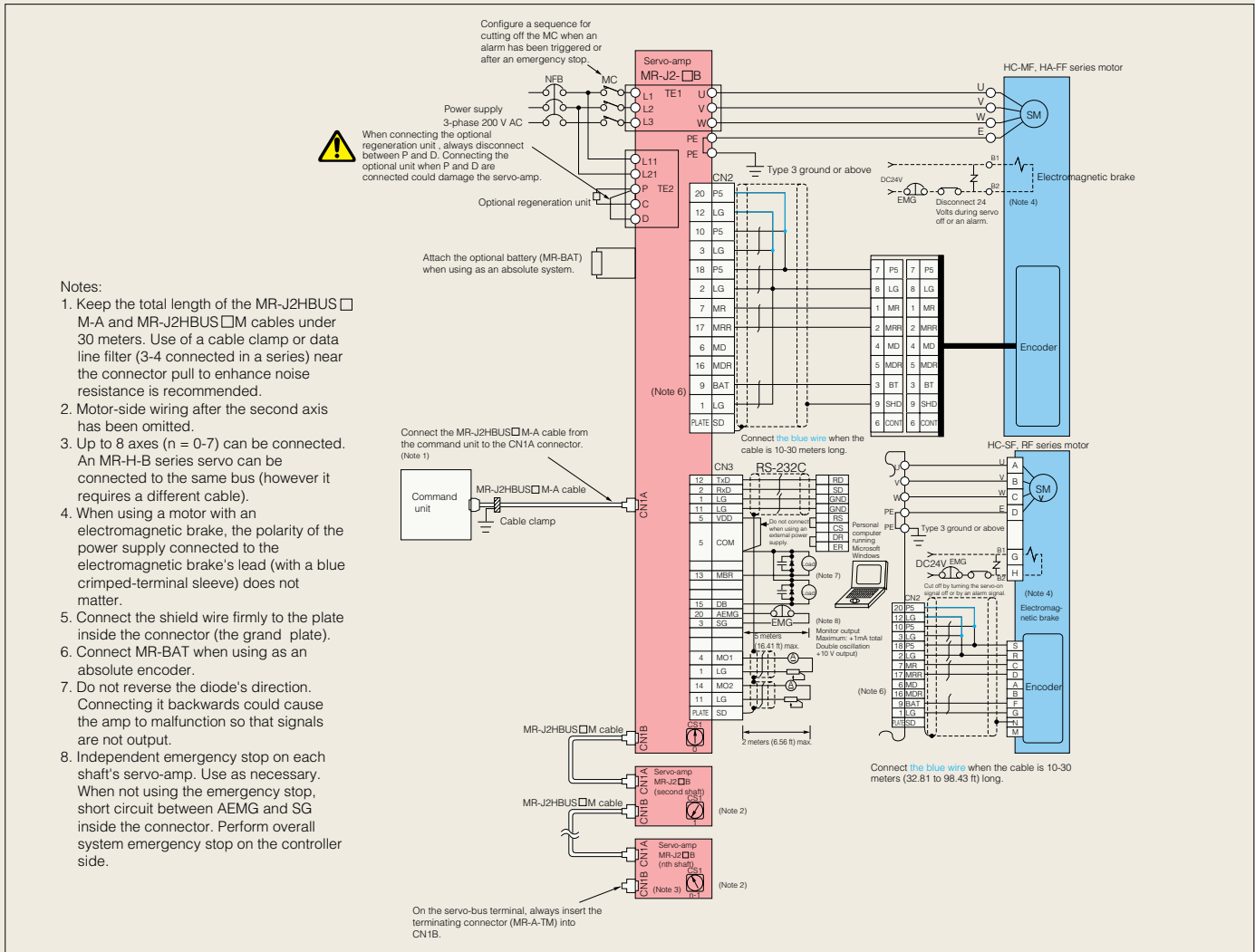

Explanation of terminals

Terminal block

Signal	Abbreviation	Terminal block	Description of function/application
Alternating power supply	L1, L2, L3	TE1	Connect to a 3-phase 200 to 230V 50/60Hz commercial power supply. There are no phase sequence limitations.
	L11, L21	TE2	Connect to a single-phase 200 to 230V 50/60Hz commercial power supply. Supply power from the same source as that for L1, L2, and L3. Turn on before or simultaneously with L1, L2, and L3. Turn off simultaneously with or after L1, L2, and L3.
Motor output	U, V, W	TE1	Connect to the U, V, and W terminals of the motor's power supply. The motor will not rotate properly if an error is made in the phase sequence.
Regeneration brake resistor	P, C, D	TE2	When using the optional regeneration unit, remove the wires connecting P and D, and connect the optional regeneration unit between P and C.
Ground	PE	chassis	Ground with the motor at one point. Connected to the chassis.

Connectors – Serial bus version (available soon)

Connector	Signal	Description of function/application
CN1A	Bus cable previous axis connection	Connector for bus cable previous axis connection. Connect to controller or previous axis servo-amp.
CN1B	Bus cable succeeding axis connection	Connector for bus cable succeeding axis connection. Connect to succeeding axis servo-amp, terminating connector, or absolute position maintenance battery unit.
CN2	Encoder signal	Connect to motor encoder.
CN3	Serial interface	Connect to personal computer.

Safety Features

The servo-amp possesses the following safety features for complete protection of itself and the servomotor. To protect the unit, when a safety circuit is activated output is suspended by cutting off power to the transistor base. When this happens, the dynamic brake is activated and stops the motor. An alarm number is displayed on the motion controller or servo-amp's LED display. After eliminating the cause, turn off the control power and reset.

When a warning (92 and below) has been triggered operation will not stop. But if the condition is not resolved, an alarm will be triggered. Identify and eliminate the cause immediately.

	Alarm LED display	Safety feature name	Description
Alarm code	10	Insufficient voltage	Is activated when the power supply's voltage falls below a certain level or when a sudden power outage of more than 15 milliseconds occurs.
	11	Board error 1	Is activated when an error is detected in the printed board.
	12	Memory error 1	Is activated when an error is detected in the printed board's memory.
	13	Clock error	Is activated when an error is detected in the printed board.
	15	Memory error 2	Is activated when an error is detected in the printed board's memory.
	16	Encoder error 1	Is activated when an error is detected in the printed board's memory. Is activated when a different type of encoder is detected and communication with encoder cannot be performed normally.
	17	Board error 2	Is activated when an error is detected in a servo-amp board component.
	18	Board error 3	Is activated when an error is detected in the printed board.
	20	Encoder error 2	Is activated when an error is detected in the encoder or encoder cable.
	24	Output side ground fault	Activates when the servo-amp output phases U, V.
	25	ABS data loss	Is activated when the battery's voltage falls and absolute data is lost.
	30	Regeneration error	Is activated when an error is detected in the regeneration circuit or when there is an excess load on the regeneration brake resistor due to excess regeneration frequency.
	31	Excess speed	Is activated when the motor rotation speed is detected to have exceeded the permissible rotation speed.
	32	Excess current	Is activated when excess current is detected.
	33	Excess voltage	Is activated when excess converter voltage is detected.
	34	CRC error	Is activated when a communications error is detected in the bus cable (MR-J2BUS□M).
	35	Command pulse error	Is activated when an excess frequency command pulse is input.
	36	Transfer error	Is activated when an error is detected in the motion network cable or the printed board.
	37	Parameter error	Is activated when parameters are detected to be outside the setting range through a parameter check performed when the power is turned on.
46	Motor overheat	Is activated when activation, due to motor overheating, of the thermal protector inside the encoder is detected.	
50	Overload 1	Is activated when an overload is detected in the motor or servo-amp.	
51	Overload 2	Is activated when an overload is detected in the motor or servo-amp.	
52	Excess error	Is activated when the difference between the input pulse and return pulse is detected to have exceeded 80 k pulses when operating in position control mode.	
88	Watchdog	Is activated when the CPU fails.	
Warning	92	Battery disconnection error	Is activated when the battery wire connected to the encoder becomes disconnected (the ABS data is not lost).
	96	Origin set error	Is activated when the origin is not set following the input of a CR (clear) signal in an absolute system.
	E0	Over regeneration warning	Regenerative resistor load has reached 85% of the alarm level.
	E1	Overload warning	Overload has reached 85% of the alarm level.
	E3	ABS data counter warning	Error in the absolute encoder pulse.
	E4	Parameter warning	Is activated when the unit reaches 85% of the overload alarm level.
	E6	Servo emergency stop	External emergency stop signal is released.
	E7	Battery warning	Is activated when the battery's voltage falls.
E9	Main circuit off warning	Activates when the main circuit voltage (P-N) is under 215V with the SERVO ON (SON) signal at ON.	

Notes:

1. The state under which regeneration error (alarm 30) and overload 1 and 2 (alarms 50 and 51) were activated is maintained inside the controller after the safety circuit is activated. Memory contents are cleared when the control voltage is turned off, but maintained by turning the RES terminal on.
2. Resetting the unit repeatedly by turning the control power supply off and on after alarms 30, 50, and 51 have been triggered can damage the components through overheating. Resume operation after definitely eliminating the cause of the alarm.

SERVO AMPLIFIERS MELSERVO J2-C

Built-in Single Axis Amplifier

Positioning and speed data
can be easily set by parameters so a
positioning program is not required.
Multidrop operation up to 32 axes is
possible with the RS485 (422) interface.



Peripheral Equipment

Connections with peripheral equipment

Peripheral equipment is connected to the MR-J2-C as described below.

Connectors, options, and other necessary equipment are available to allow users to easily setup the J2-C and begin using it right away!

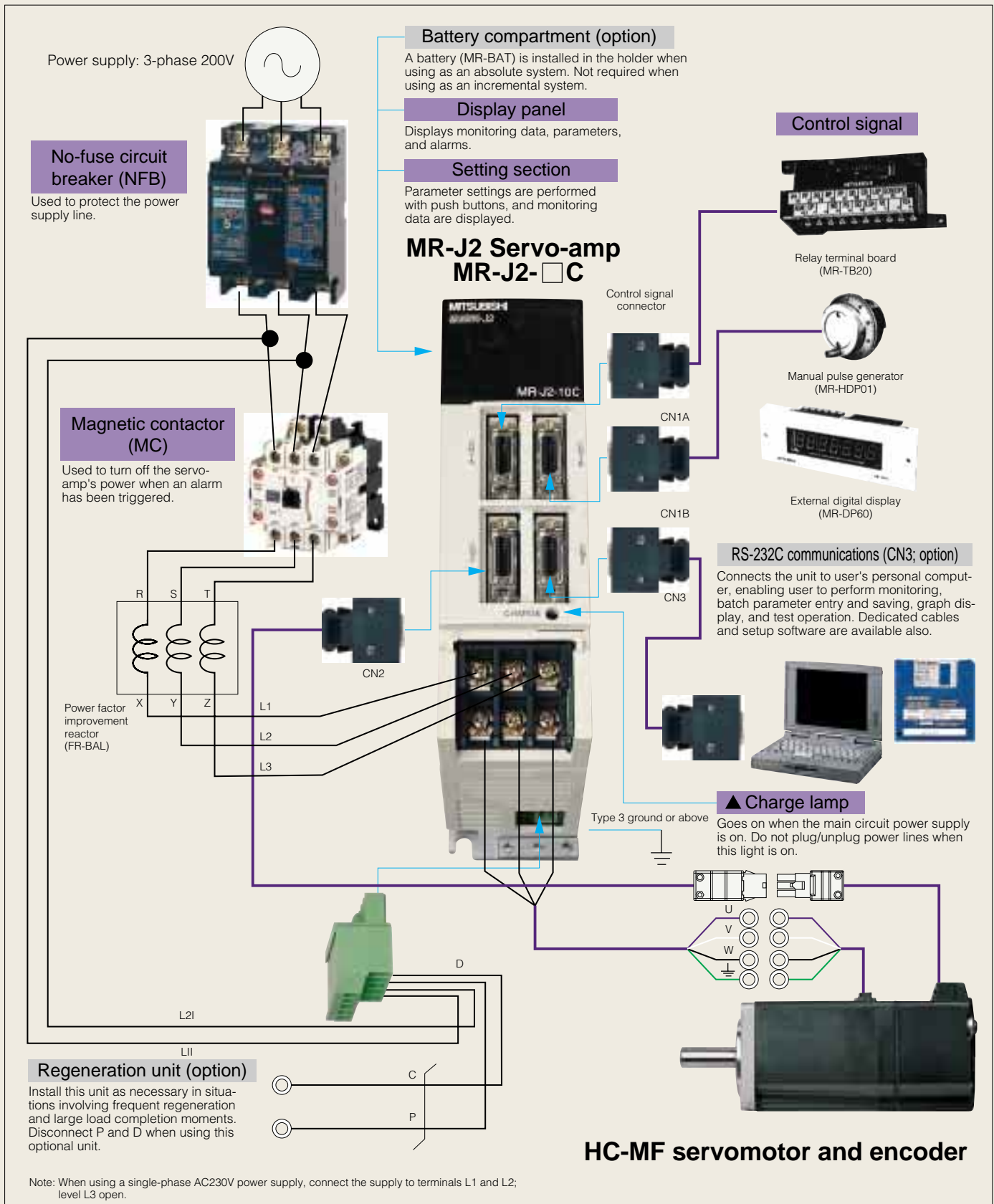

Features

With built-in positioning function

Features

- Settings such as positioning data (target positions), motor RPM, and acceleration/deceleration times can be set in a point table with the feel of parameters.
- You can position using DI/O for simple, programless positioning.
- Allows multi-drop operation (up to 32 axes) using RS-485 serial communications.
- Highly responsive. The servo motor starts running a maximum of 3 ms after the start signal is input.

System configuration

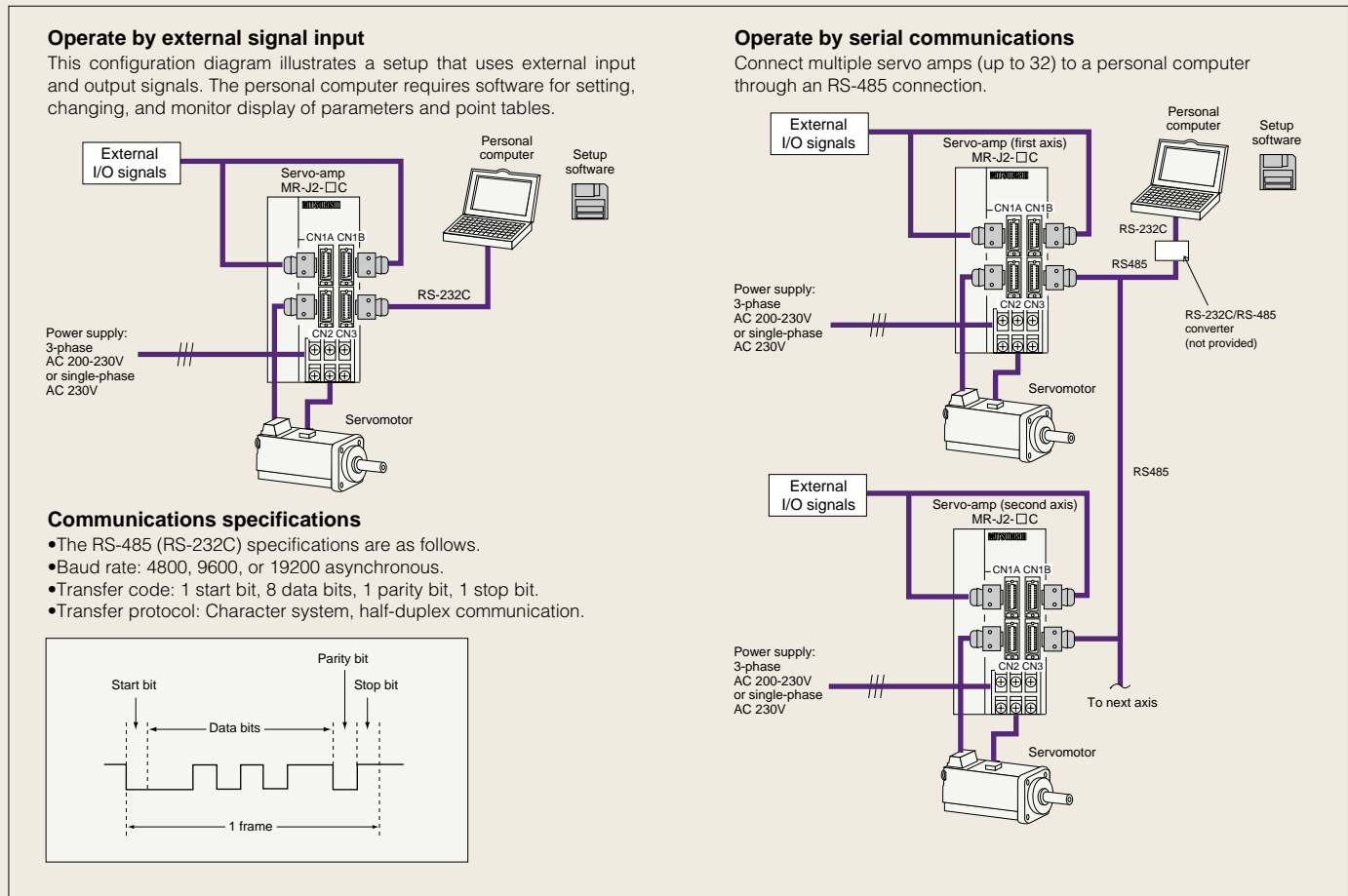

Point table

Item	Setting range	Unit	Description
Target position	-999999~999999	$\times 10^{\text{STM}} \mu\text{m}$	Moves the set value. STM is the ratio to the data.
Motor (r/min)	0 to permissible	r/min	Sets the command rpm for the servomotor used for positioning.
Acceleration time constant	0~20000	msec	Sets the acceleration time constant.
Deceleration time constant	0~20000	msec	Sets the deceleration time constant.
Dwell time	0~20000	msec	Runs the next point table after the set dwell time.
Auxiliary function	0~1	—	0: Positions and stops (waits for start signal). 1: Continues operation for the next positioning block without stopping.

Sample data settings

Point No.	Target position	Motor (r/min)	Acceleration time constant	Deceleration time constant	Dwell time	Auxiliary functions
1	1000	2000	200	200	0	1
2	2000	1600	50	60	0	0
⋮	⋮	⋮	⋮	⋮	⋮	⋮
15	999999	3000	100	110	0	0

Note: Set the auxiliary function for point No.1 to 1 to get auxiliary function 1 as shown in the figure below. Set the auxiliary function for point No.1 to 0 to get auxiliary function 0 as shown in the figure below, which requires a start signal.

Auxiliary function 1

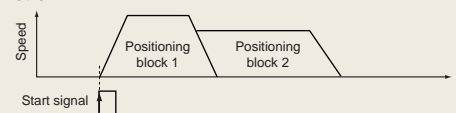

Auxiliary function 0

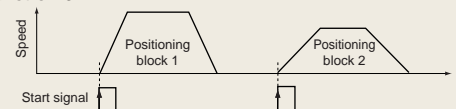

Servo-amp Specifications

Servo-amp model MR-J2-		10C	20C	40C	60C	70C	100C	200C	350C		
Power supply	Voltage/frequency	3-phase AC 200-230V at 50/60Hz or single-phase AC 230V at 50/60Hz (note 3)					3-phase AC 200-230V at 50/60Hz				
	Permissible voltage fluctuation	3-phase AC 200-230V: AC 170-253 at 50/60Hz Single-phase AC 230V: AC 207-253 at 50/60Hz					3-phase AC 170-253V at 50/60Hz				
	Permissible frequency fluctuation	±5% max.									
Control method		Sine wave PWM control and current control methods									
Dynamic brake		Built-in (note 2)									
Protection functions		Overcurrent breaking, regenerative overvoltage breaking, overload breaking (electronic thermal), servo motor overheating protection, sensor malfunction protection, regenerative malfunction protection, insufficient voltage, power outage protection, overspeed protection, protection against exceeding tolerances.									
Speed frequency response		250Hz min.									
Command method	Input point table number	Operating specification	Positions according to the specification of the point table No. (15 points. Three points set when shipped.)								
		Input positioning command	Set in point table. Feed for 1 point settable between ±1μm and ±999.999 mm.								
		Input speed command	Set in point table. Acceleration/deceleration time set in point table. S-curve acceleration/deceleration constant set by parameter 14.								
		System	Signed absolute value commands, increment value commands.								
	Input position data	Operating specification	Positioning by RS-485 (RS-232C) communications data.								
		Input positioning command	Positioning by RS-485 (RS-232C) communications. Feed for 1 point settable between ±1μm and ±999.999 mm.								
		Input speed command	Positioning by RS-485 (RS-232C) communications. Acceleration/deceleration time also set by RS-485 (RS-232C) communications. S-curve acceleration/deceleration constant set by parameter 14.								
		System	Signed absolute value commands, increment value commands.								
	Operating mode	Automatic operation mode	Point table	Point table number input and position data input system. Each positioning operation based on position and speed commands.							
			Automatic continuous operation	Speed changing operation (2 speeds to 15 speeds), automatic continuous positioning operation (2 to 15 points)							
Manual operation mode		JOG	Inches upon contact input or RS-485 (RS-232C) communications based on speed commands set by parameter.								
		Manual pulse generator	Manual feed by manual pulse generator. Command pulse ratio: Use parameter to select ×1, ×10, or ×100.								
Manual homing mode		Dog system (find rear end)	Returns to origin upon Z phase pulse after passing through near-point dog. Settable origin address, settable origin shift, and selectable direction for return to origin. Automatic retreat on dog back to origin and automatic stroke retreat function.								
	Count system (find front end)	Returns to origin upon sensor pulse count after touching near-point dog. Settable origin address, settable origin shift, and selectable direction for return to origin. Automatic retreat on dog back to origin and automatic stroke retreat function.									
	Data set system	Returns to origin without dog. Set any position as the origin using manual operation or the like. Settable origin address.									
	Impact system	Returns to origin upon hitting end of stroke. Settable origin address. Selectable direction for return to origin.									
	Ignore origin (SON position origin)	Uses position where SON signal becomes ON as origin. Settable origin address.									
Other functions		Absolute position detection and backlash compensation. Overtravel prevented by external limit switch. Software stroke limit and override via external analog.									
Structure		Open (IP00)									
Environment	Ambient temperature	0 to 55°C (non freezing). Storage -20 to 65°C (non freezing)									
	Ambient humidity	90% RH max. (non condensing). Storage 90% RH max. (non condensing)									
	Atmosphere	No corrosive gases, combustible gases, oil mist, or dust within control panel.									
	Maximum altitude	1000 meters or less above sea level.									
	Maximum vibration	5.9 m/s ² [0.6G] max.									
Weight kg (lb)		0.7 (1.5)	0.7 (1.5)	1.1 (2.4)	1.1 (2.4)	1.7 (3.7)	1.7 (3.7)	2.0 (4.4)	2.0 (4.4)		

Notes: 1. The rated output capacity and rated RPM of the servomotor when assembled is for the stated supply voltage and frequency. No guarantees are made for lowered supply voltages.
2. Models without dynamic brakes (MR-J2-□□D) can also be handled using special specifications.
3. The torque characteristics when combined with a servomotor are for single phase AC 230V.

Standard Wiring Diagram

Sample connections for MR-J2-C

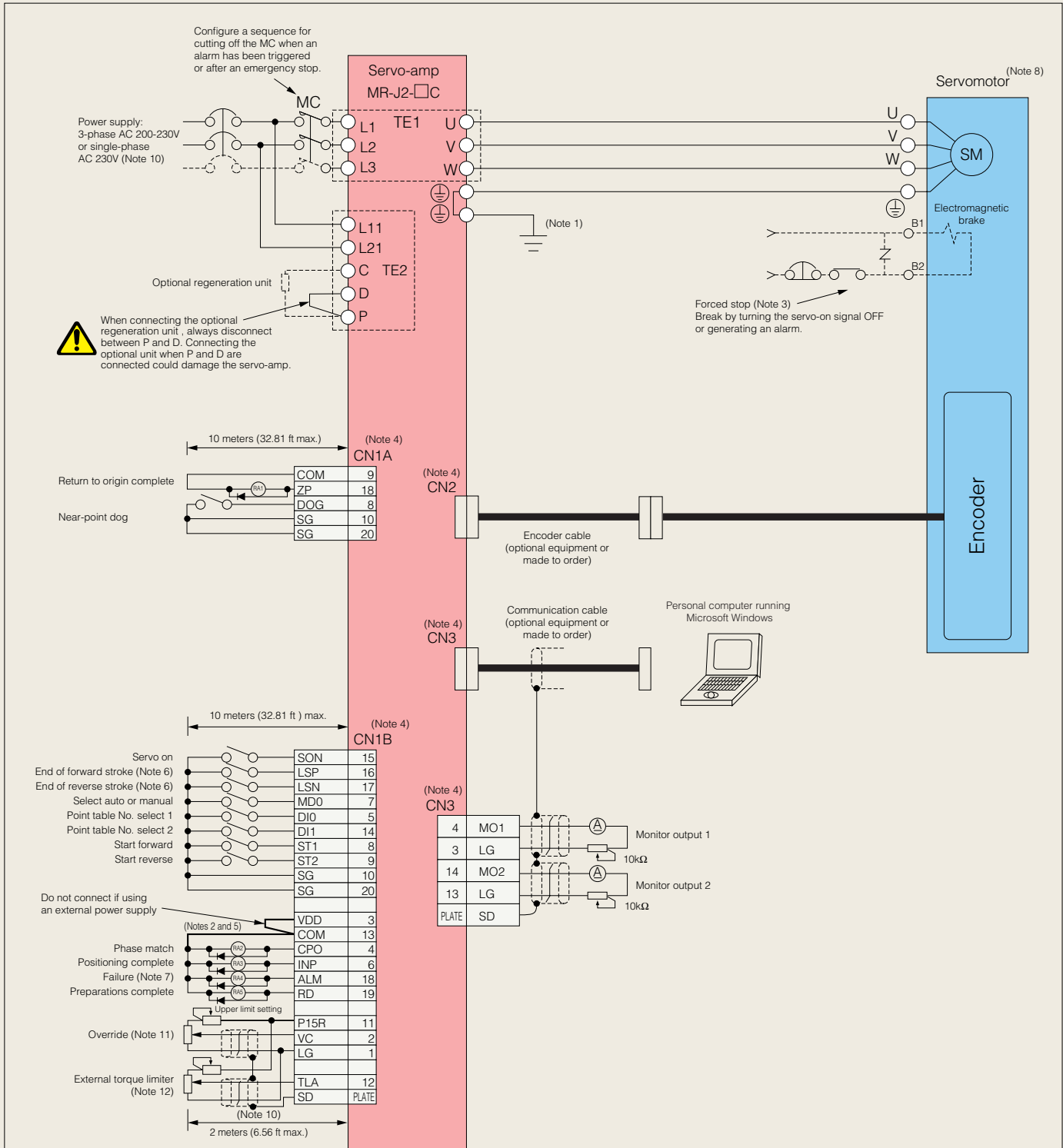

Notes:

- Always connect the servo-amp protection ground (PE) (for preventing shocks) to the control board's protection ground (PE).
- Make sure you have the correct diode orientation. Connecting it backwards will damage the servo-amp, prevent output of signals, and prevent protection circuits such as forced stops from operating.
- Always install a forced stop switch.
- CN1A, CN1B, CN2 and CN3 are all the same shape. Connecting them wrong can cause damage. See the MELSERVO-J2-C Servo-Amp Technical Documents Collection for details.
- Keep the sum total of current flowing through the external relays to 80 mA or less. To exceed 80 mA you must supply an external power supply for the interface.
- During operation, be sure to short the forward and reverse stroke ends (LSN and LSP) to SG.
- Make ALM conductive to COM during normal operation with no alarm.
- Connection methods differ in different servomotor series. See the MELSERVO-J2-C Servo-Amp Technical Documents Collection for details.
- Connect signals of the same name within the servo-amp.
- When using a single-phase AC 230 V power supply, connect the supply to terminals L1 and L2; leave L3 open.
- If using an override (VC), make it so an override selection (OVR) device can be used.
- If using a torque limiter (TLA), make it so an external torque limit selector (TL) device and an internal torque limit selector (TL2) device can be used.

Options

Options

● Cables and connectors (MR-J2-A series)

Cable and connector options are shown in the diagram below.

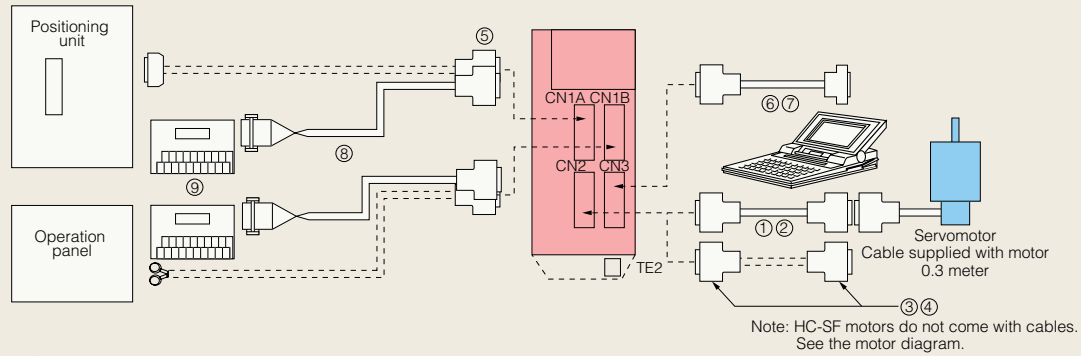

● Cables and connectors

	Item	Model	Description		
Select one for use with CN2	①	Encoder cable for use with HC-MF, UF3000r/min and HA-FF series motors MR-JCCBL□M-H□ (note 1, 3)	Amp-side connector (made by 3M, or an equivalent product) 10120-3000VE (connector) 10320-52F0-008 (shell kit)	Junction connector (made by AMP) 1-172161-9 (black connector housing)	Encoder
		MR-JCCBL□M-L□ (note 1,3)			
	②	Encoder cable for use with HC-SF series motors and HC-RF, UF2000r/min MR-JHSCBL□M-H□ (note 3)	Amp-side connector (made by 3M, or an equivalent product) 10120-3000VE (connector) 10320-52F0-008 (shell kit)	Junction connector (made by Japan Aviation Electronics Industry) MS-3057-12A (cable clamp) MS3106B20-29S (straight plug)	Encoder
		MR-JHSCBL□M-L□ (note 3)			
③	Encoder connector set for use with HC-MF and HA-FF series motors, HC-UF3000r/min MR-J2CNM		Junction connector (made by AMP) 1-172161-9 (black connector housing) 170363-1 (connector pin)		(note 2)
Select one for use with CN1	⑤	CN1 connector MR-J2CNI	Amp-side connector (made by 3M, or an equivalent product) 10120-3000VE (connector) 10320-52F0-008 (shell kit)		
	⑧	Junction terminal block cable MR-J2TBL□M (note 3)		Junction terminal block-side connector HIF3BA-20D-2.54R (connector)	Amp-side connector (made by 3M, or an equivalent product) 10120-3000VE (connector) 10320-52F0-008 (shell kit)
For use with CN3					
	⑦	DOS/V communications cable MR-CPCATCBL3M		Connector for optional RS-232C unit (made by 3M, or an equivalent product) 10120-3000VE (connector) 10320-52F0-008 (shell kit)	Connector to DOS/V personal computer GM-9LM (made by Honda Tsushin)
⑨					

Notes:

1. -H and -L indicate bending life. -H products have a long bending life.
2. AMP 172161 (white) can also be used for the connector housing.
3. □Enter 5 or 10 in box for cable length in meters.

Options

● Cables and connectors (for the HC-SF, RF and UF series)

All of these connectors satisfy IP65 and EN standards.

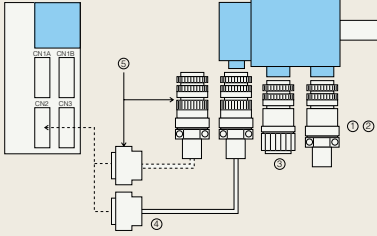

● List of cables and connectors (for the HC-SF, RF and UF series)

All of these connectors satisfy IP65 and EN standards.

Item	Model	Details	Servomotor pairing
①	MR-PWCNS1 (straight model)	Plug (made by DDK) CE05-6A22-23SD-B-BSS Cable clamp (straight, made by DDK) CE3057-12A-2 (D265)	HC-SF52, 102, 152 HC-RF103, 153, 203
	MR-PWCNS2 (straight model)	Plug (made by DDK) CE05-6A22-23SD-B-BSS Cable clamp (straight, made by DDK) CE3057-12A-2 (D265)	HC-SF202, 352
③	MR-BKCN (straight model)	Plug (made by DDK) MS3106A10SL-4S (D190) Cable connector (straight, made by [Daiwa Dengyo]) YOS10-5-8	HC-SF202, 352
④	MR-ENC□M-H □=cable length: 2, 5, 10, 20, 30m	Plug (made by DDK) MS3106A20-29S (D190) Backshell (made by DDK) CE02-20BS-S Cable clamp (made by DDK) CE3057-12A-3 (D265) Connect for amp (3M or similar product) 10120-3000VF (connector) 10320-52F0-008 (shell kit)	HC-SF, RF and UF series
⑤	MR-ENCNS	Plug (made by DDK) MS3106A10SL-4S (D190) Backshell (made by DDK) CE02-20BS-S Straight cable clamp (made by DDK) CE3057-12A-3 (D265) Connect for amp (3M or similar product) 10120-3000VF (connector) 10320-52F0-008 (shell kit)	HC-SF, RF and UF series

Note: The encoder cable is not oil-resistant.

Ordering information for customers

● Servomotor power connectors

The motors are not provided with power connectors. Please order options from us, or choose from among the following recommended products. To order the following recommended products, customers should contact the relevant manufacturer directly.

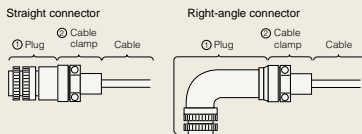

Motor model	Application	① Plug (made by DDK)		② Cable clamp (made by DDK)	
		Type	Model	Cable diameter	Model
HC-SF52, 102, 152 HC-RF103, 153, 203	Satisfy IP65, EN standards	Straight connector	CE05-6A22-23SD-B-BSS	9.5-13	CE3057-12A-2 (D265)
		Right-angle connector	CE05-6A22-23SD-B-BSS	12.5-16	CE3057-12A-1 (D265)
	Normal environment	Straight connector	MS3106B22-23S	9.5-13	CE3057-12A-2 (D265)
		Right-angle connector	MS3106B22-23S	12.5-16	CE3057-12A-1 (D265)
HC-SF202, 352	Satisfy IP65, EN standards	Straight connector	CE05-8A24-10SD-B-BAS	15.9	MS-3057-12A
		Right-angle connector	CE05-8A24-10SD-B-BAS	(Inner diameter of bushing)	MS-3057-12A
	Normal environment	Straight connector	MS3106B24-10S	13-15.5	CE3057-16A-2 (D265)
		Right-angle connector	MS3106B24-10S	15-19.1	CE3057-16A-1 (D265)
		Straight connector	MS3106B24-10S	13-15.5	CE3057-16A-2 (D265)
		Right-angle connector	MS3106B24-10S	15-19.1	CE3057-16A-1 (D265)
			15.9 & 19.1	MS-3057-16A	
			(Inner diameter of bushing)	MS-3057-16A	

● Encoder connectors

The motors are not provided with encoder connectors. Please order options from us, or choose from among the following recommended products. To order the following recommended products, customers should contact the relevant manufacturer directly.

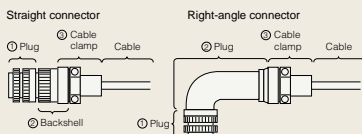

Motor model	Application	① Plug (made by DDK)	② Backshell (made by DDK)		③ Cable clamp (made by DDK)	
			Type	Model	Cable diameter	Model
HC-SF series HC-RF series	Satisfy IP65, EN standards	MS3106A20-29S (D190)	Straight connector	CE02-20BS-S	6.8-10	CE3057-12A-3
			Right-angled connector	CE-20BA-S		

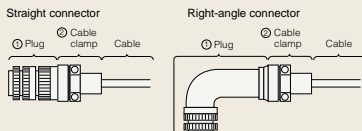

Motor model	Application	① Plug (made by DDK)		② Cable clamp (made by DDK)	
		Type	Model	Cable diameter	Model
HC-SF series HC-RF series	Normal environment	Straight connector	MS3106B20-29S	15.9	MS3057-12A (Inner diameter of bushing)
		Right-angled connector	MS3106B20-29S		

● Electromagnetic brake connectors

The motors are not provided with electromagnetic brake connectors. Please order options from us, or choose from among the following recommended products. To order the following recommended products, customers should contact the relevant manufacturer directly.

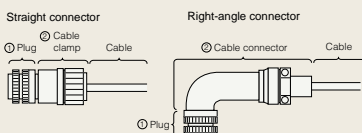

Motor model	Application	① Plug (made by DDK)	② Cable clamp (made by DDK)		
			Type	Cable diameter	Model
HC-SF202, 352	Satisfy IP65, EN standards	MS3106A10SL-4S (D190)	Straight connector	4-8	ACS-08RL-MS10F
				8-12	ACS-12RL-MS10F
				5-8.3	YSO10-5-8
			Right-angled connector	4-8	ACA-08RL-MS10F
				8-12	ACA-12RL-MS10F
				5-8.3	YLO10-5-8



Motor model	Application	① Plug (made by DDK)		② Cable clamp (made by DDK)	
		Type	Model	Cable diameter	Model
HC-SF202, 352	Normal environment	Straight connector	MS3106A10SL-4S	5.6	MS3057-4A (Inner diameter of bushing)

Options and Peripheral Equipment

● Battery (MR-BAT)

The servomotor's absolute value can be maintained by installing a battery in the servo-amp.

There is no need to install the battery when using the servomotor in incremental mode.

Note: A6BAT can be used also.

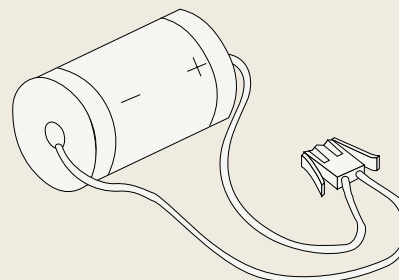

● Power factor enhancing reactor (FR-BAL)

This reactor enables users to boost the servo-amp's power factor and reduce its power capacity. It can also be used, when it is connected directly under the power transformer (500 kVA or above, wire length of 10 meters or less), to suppress current surges that occur when the power is turned on.

● Junction terminal block (MR-TB20)

All signals can be wired to this junction terminal block without a connection to CN1.

External dimensions

Mounting hole (F mounting screws)

Terminal block

Spec number

Product number

<Connection>

Unit: mm (inch)

Model	Dimensions						Weight (kg (lb))
	A	B	C	D	E	F	
FR-BAL-0.4K	135 (5.31)	64 (2.51)	120 (4.72)	120 (4.72)	45 (1.77)	M4	2 (4.4)
FR-BAL-0.75K	135 (5.31)	74 (2.91)	120 (4.72)	120 (4.72)	57 (2.24)	M4	2 (4.4)
FR-BAL-1.5K	160 (6.30)	76 (2.99)	145 (5.71)	145 (5.71)	55 (2.17)	M4	4 (8.8)
FR-BAL-2.2K	160 (6.30)	96 (3.78)	145 (5.71)	145 (5.71)	75 (2.95)	M4	6 (13.2)
FR-BAL-3.7K	220 (8.66)	95 (3.74)	200 (7.87)	200 (7.87)	70 (2.76)	M5	8.5 (18.7)
FR-BAL-7.5K	220 (8.66)	125 (4.92)	205 (8.07)	200 (7.87)	100 (3.94)	M5	14.5 (32.0)

External dimensions

Unit: mm (inch)

Compatible wire: 2 mm² max. (compressed terminal width: 8.1 mm max.)

Terminal block screw size :M3.5

Options and Peripheral Equipment

● Optional regeneration unit

Unit: mm (inch)

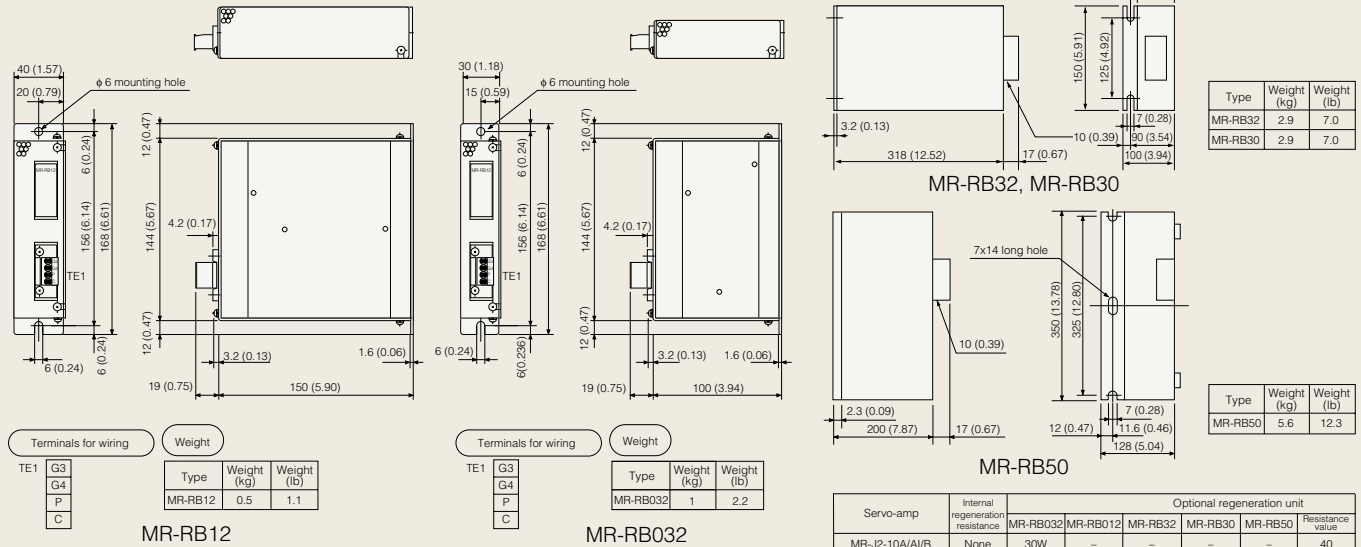

Selection of peripheral equipment

● Electric wires, no-fuse circuit breakers, magnetic contactors

Servo-amp	No-fuse circuit breaker	Magnetic contactor	Electric wire size (mm ²)				Power factor enhancing reactor
			L1, L2, L3	U, V, W ⊕	L11, L21	P, C, D	
MR-J2-10A/A1/B/C	5A NF-30	S-N10	2	1.25	1.25	2	FR-BAL-0.4K
MR-J2-20A/B/C	5A NF-30	S-N10	2	1.25	1.25	2	FR-BAL-0.4K
MR-J2-40A/B/20A1/C	10A NF-30	S-N10	2	1.25	1.25	2	FR-BAL-0.75K
MR-J2-60A/B/40A1/C	15A NF-30	S-N10	2	1.25	1.25	2	FR-BAL-1.5K
MR-J2-70A/B/C	15A NF-30	S-N10	2	2	1.25	2	FR-BAL-1.5K
MR-J2-100A/B/C	15A NF-30	S-N10	2	2	1.25	2	FR-BAL-2.2K
MR-J2-200A/B/C	20A NF-30	S-N18	3.5	3.5	1.25	2	FR-BAL-3.7K
MR-J2-350A/B/C	30A NF-30	S-N20	5.5	5.5 (3.5 ^{Note 2})	1.25	2	FR-BAL-7.5K

Notes: 1. Assuming use of a 600V polyvinyl chloride insulated wire, with wires in table having a length of 30 meters.
2. When connecting to servomotor HC-RF203 use a 3.5mm² electric wire.

● Surge suppressor

Attach surge suppressors to the servo-amp and signal cable's AC relays, AC valves, and AC power supply brake. Attach diodes to the DC relays and DC valves.

Sample configuration

Surge suppressor: 972A-2003 504 11 (rated 200V, made by Matsuo Denki)

Diode: A diode with resisting pressure 4 or more times greater than the relay's drive voltage/current, and 2 or more times greater than the current.

● Data line filter

Attaching a data line filter to the pulse output cable or motor encoder cable of the pulse train command unit (AD75, etc.) is effective in preventing noise penetration.

Sample configuration

Data line filter: ESD-SR-25 (made by Tokin), ZCAT3035-1330 (made by TDK)

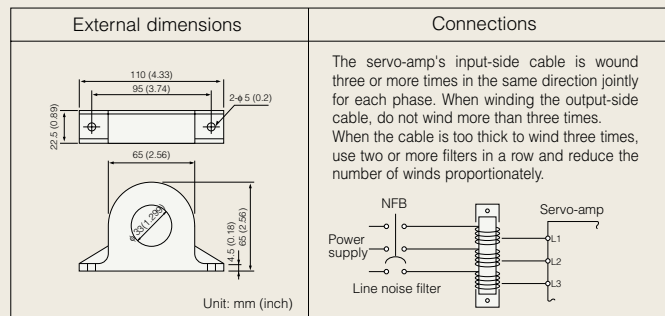

● Line noise filter FR-BSF01

Effective in suppressing radio noise emitted from the servo-amp's power supply side or output side and high-frequency current leakage (zero-phase current). Especially effective in the 0.5 MHz to 5 MHz band. The greater the number of coils, the more effective this filter is.





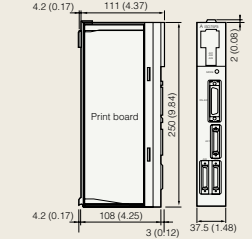
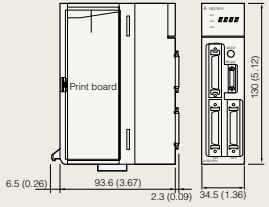

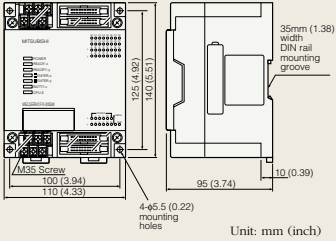
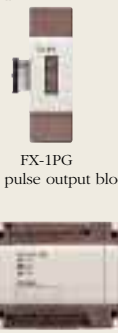
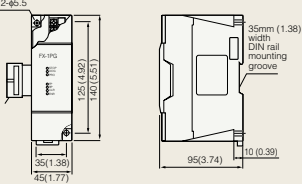
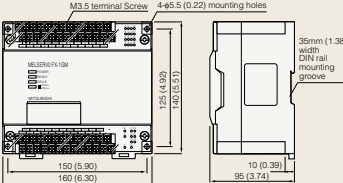
Command Unit

The following positioning controllers are available for the MR-J2-A series servo-amps. Choose the unit that best fits your operating objectives and system size.

Name	Specification/application overview	External dimensions																																								
<p>MELSEC-A, MELSEC-QnA series compatible AD75P A1SD75P</p>  <p>AD75P A1SD75P</p>	<p>All of the units have been made more compact: 1 slot for 1 to 3 axes. And they are compatible with the A and QnA series PLC's. A high-precision, highly functional positioning unit that uses a 32-bit RISC chip.</p> <table border="1" data-bbox="443 622 1152 943"> <thead> <tr> <th>Item</th> <th>Model AD75P1 A1SD75P1</th> <th>AD75P2 A1SD75P2</th> <th>AD75P3 A1SD75P3</th> </tr> </thead> <tbody> <tr> <td>Number of control axes</td> <td>1</td> <td>2 simultaneous 2 independent</td> <td>3 simultaneous 3 independent</td> </tr> <tr> <td>Interpolation functions</td> <td>None</td> <td>2-axes linear interpolation 2-axes circular interpolation</td> <td>2-axes linear interpolation 2-axes circular interpolation</td> </tr> <tr> <td>Control mode</td> <td colspan="3">PTP control, locus control, speed control, speed position control</td> </tr> <tr> <td>Command mode</td> <td colspan="3">Incremental, absolute</td> </tr> <tr> <td>Maximum number of output pulses</td> <td colspan="3">±2147483648</td> </tr> <tr> <td>Maximum pulse frequency</td> <td colspan="3">Differential output: 400 kpps, open collector: 200 kpps</td> </tr> <tr> <td>Positioning pattern</td> <td colspan="3">600 patterns/shaft (100 patterns from ladder)</td> </tr> <tr> <td>Input/output duty points</td> <td colspan="3">32</td> </tr> <tr> <td>Acceleration/deceleration patterns</td> <td colspan="3">4, automatic trapezoid, S-acceleration/deceleration</td> </tr> </tbody> </table>	Item	Model AD75P1 A1SD75P1	AD75P2 A1SD75P2	AD75P3 A1SD75P3	Number of control axes	1	2 simultaneous 2 independent	3 simultaneous 3 independent	Interpolation functions	None	2-axes linear interpolation 2-axes circular interpolation	2-axes linear interpolation 2-axes circular interpolation	Control mode	PTP control, locus control, speed control, speed position control			Command mode	Incremental, absolute			Maximum number of output pulses	±2147483648			Maximum pulse frequency	Differential output: 400 kpps, open collector: 200 kpps			Positioning pattern	600 patterns/shaft (100 patterns from ladder)			Input/output duty points	32			Acceleration/deceleration patterns	4, automatic trapezoid, S-acceleration/deceleration			<p>■ AD75P positioning unit</p>  <p>■ A1SD75P positioning unit</p>  <p>Unit: mm (inch)</p>
Item	Model AD75P1 A1SD75P1	AD75P2 A1SD75P2	AD75P3 A1SD75P3																																							
Number of control axes	1	2 simultaneous 2 independent	3 simultaneous 3 independent																																							
Interpolation functions	None	2-axes linear interpolation 2-axes circular interpolation	2-axes linear interpolation 2-axes circular interpolation																																							
Control mode	PTP control, locus control, speed control, speed position control																																									
Command mode	Incremental, absolute																																									
Maximum number of output pulses	±2147483648																																									
Maximum pulse frequency	Differential output: 400 kpps, open collector: 200 kpps																																									
Positioning pattern	600 patterns/shaft (100 patterns from ladder)																																									
Input/output duty points	32																																									
Acceleration/deceleration patterns	4, automatic trapezoid, S-acceleration/deceleration																																									
<p>MELSEC-F series-compatible 2-axis positioning units FX-20GM E-20GM</p>  <p>FX-20GM E-20GM</p>	<p>Users can choose either the FX-20GM alone or coupled with an FX PLC. This units offer a broad range of uses, from interpolation operation to high-frequency feed operation.</p> <table border="1" data-bbox="443 1166 1152 1418"> <thead> <tr> <th>Item</th> <th>Model FX-20GM / E-20GM (language-equipped model)</th> </tr> </thead> <tbody> <tr> <td>Number of control axes</td> <td>2 simultaneous, 2 independent</td> </tr> <tr> <td>Interpolation functions</td> <td>Linear interpolation, circular interpolation</td> </tr> <tr> <td>Compatible PLC</td> <td>Stand-alone use</td> </tr> <tr> <td>Command mode</td> <td>Incremental, absolute</td> </tr> <tr> <td>Absolute position encoder</td> <td>Can be used with MR-H model servo with ABS function</td> </tr> <tr> <td>Maximum number of output pulses</td> <td>C±2,147,483,648</td> </tr> <tr> <td>Maximum pulse frequency</td> <td>Open collector: 200 kpps, during interpolation operation: 100 kpps</td> </tr> <tr> <td>Program memory</td> <td>Built-in 7.8 k step RAM</td> </tr> </tbody> </table>	Item	Model FX-20GM / E-20GM (language-equipped model)	Number of control axes	2 simultaneous, 2 independent	Interpolation functions	Linear interpolation, circular interpolation	Compatible PLC	Stand-alone use	Command mode	Incremental, absolute	Absolute position encoder	Can be used with MR-H model servo with ABS function	Maximum number of output pulses	C±2,147,483,648	Maximum pulse frequency	Open collector: 200 kpps, during interpolation operation: 100 kpps	Program memory	Built-in 7.8 k step RAM	<p>■ FX-20GM/E-20GM 2-axis positioning unit</p>  <p>Unit: mm (inch)</p>																						
Item	Model FX-20GM / E-20GM (language-equipped model)																																									
Number of control axes	2 simultaneous, 2 independent																																									
Interpolation functions	Linear interpolation, circular interpolation																																									
Compatible PLC	Stand-alone use																																									
Command mode	Incremental, absolute																																									
Absolute position encoder	Can be used with MR-H model servo with ABS function																																									
Maximum number of output pulses	C±2,147,483,648																																									
Maximum pulse frequency	Open collector: 200 kpps, during interpolation operation: 100 kpps																																									
Program memory	Built-in 7.8 k step RAM																																									
<p>MELSEC-F series-compatible 1-axis positioning units FX-1PG FX-1GM</p>  <p>FX-1PG 1-axis pulse output block</p> <p>FX-1GM pulse output block unit</p>	<p>The FX-1PG can be expanded for up to 8 axis, is available as FX-sequencer special-unit blocks. The units can be used for simple positioning applications.</p> <table border="1" data-bbox="443 1694 1152 1901"> <thead> <tr> <th>Item</th> <th>Model FX-1PG / FX-1GM</th> </tr> </thead> <tbody> <tr> <td>Number of control axes</td> <td>1</td> </tr> <tr> <td>Compatible sequencer</td> <td>Stand-alone use, FX2/FX2C FX2/FX2C series</td> </tr> <tr> <td>Command mode</td> <td>Incremental, absolute</td> </tr> <tr> <td>Maximum number of output pulses</td> <td>±2,147,483,648</td> </tr> <tr> <td>Maximum pulse frequency</td> <td>Open collector: 100 kpps</td> </tr> <tr> <td>Program memory</td> <td>Communication with PLC</td> </tr> </tbody> </table>	Item	Model FX-1PG / FX-1GM	Number of control axes	1	Compatible sequencer	Stand-alone use, FX2/FX2C FX2/FX2C series	Command mode	Incremental, absolute	Maximum number of output pulses	±2,147,483,648	Maximum pulse frequency	Open collector: 100 kpps	Program memory	Communication with PLC	<p>■ FX-1PG 1-axis pulse output block</p>  <p>■ FX-1GM 1-axis positioning units</p>  <p>Unit: mm (inch)</p>																										
Item	Model FX-1PG / FX-1GM																																									
Number of control axes	1																																									
Compatible sequencer	Stand-alone use, FX2/FX2C FX2/FX2C series																																									
Command mode	Incremental, absolute																																									
Maximum number of output pulses	±2,147,483,648																																									
Maximum pulse frequency	Open collector: 100 kpps																																									
Program memory	Communication with PLC																																									

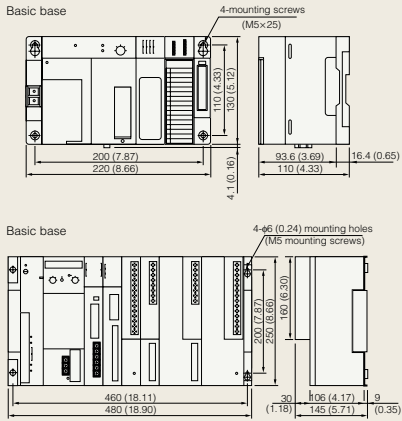
The following servo-system controllers (SSC) are available for the MR-J2-B series servo-amps. Choose the unit that best fits your operating objectives and system size.

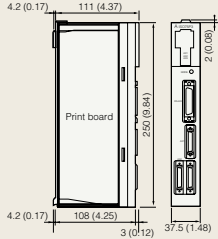
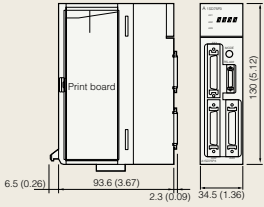
Name	Specification/application overview	External dimensions																																				
<p>A171SH/A172SH Motion controller</p>  <p>A273UH Motion controller</p> 	<p>Combination of a servo-controller with the MELSEC-A high-performance all-purpose PLC allows motion and sequence control with one single controller. This previously required two separate controllers. Four software packages are available for different applications.</p> <ul style="list-style-type: none"> Conveyor and assembly software (SV13) Automated unit software (SV22, CAMP) Machine tool peripheral software (SV43) Dedicated robot software (SV51) <table border="1" data-bbox="426 714 1076 1001"> <thead> <tr> <th>Item \ Model</th> <th>A171SH</th> <th>A172SH</th> <th>A273UH</th> </tr> </thead> <tbody> <tr> <td>Number of control axis</td> <td>4</td> <td>8</td> <td>32</td> </tr> <tr> <td>Interpolation functions</td> <td colspan="3">Linear interpolation (max. 4-axes) / Circular interpolation (2-axes)</td> </tr> <tr> <td>Control mode</td> <td colspan="3">PTP control, speed control, synchronous control, fixed distance feed speed & position control, CP control, speed switch control</td> </tr> <tr> <td>Acceleration/deceleration pattern</td> <td colspan="3">Automatic trapezoid, S-acceleration / deceleration</td> </tr> <tr> <td>Maximum inputs & outputs</td> <td>512</td> <td>1024</td> <td>2048</td> </tr> <tr> <td>Servo-amp</td> <td colspan="2">External</td> <td>External (max. 22kW) Internal (max. 600W)</td> </tr> </tbody> </table>	Item \ Model	A171SH	A172SH	A273UH	Number of control axis	4	8	32	Interpolation functions	Linear interpolation (max. 4-axes) / Circular interpolation (2-axes)			Control mode	PTP control, speed control, synchronous control, fixed distance feed speed & position control, CP control, speed switch control			Acceleration/deceleration pattern	Automatic trapezoid, S-acceleration / deceleration			Maximum inputs & outputs	512	1024	2048	Servo-amp	External		External (max. 22kW) Internal (max. 600W)	 <p>Basic base</p> <p>4-mounting screws (M5x25)</p> <p>200 (7.87) 220 (8.66) 170 (6.69) 150 (5.91) 4.1 (0.16) 93.6 (3.69) 110 (4.33) 16.4 (0.65)</p> <p>Basic base</p> <p>4-φ6 (0.24) mounting holes (M5 mounting screws)</p> <p>460 (18.11) 480 (18.90) 200 (7.87) 250 (9.84) 100 (3.94) 30 (1.18) 9.06 (4.17) 9 (0.35) 145 (5.71)</p> <p>Unit: mm (inch)</p>								
Item \ Model	A171SH	A172SH	A273UH																																			
Number of control axis	4	8	32																																			
Interpolation functions	Linear interpolation (max. 4-axes) / Circular interpolation (2-axes)																																					
Control mode	PTP control, speed control, synchronous control, fixed distance feed speed & position control, CP control, speed switch control																																					
Acceleration/deceleration pattern	Automatic trapezoid, S-acceleration / deceleration																																					
Maximum inputs & outputs	512	1024	2048																																			
Servo-amp	External		External (max. 22kW) Internal (max. 600W)																																			
<p>AD75M A1SD75M</p>  <p>AD75M A1SD75M</p>	<p>All of the units have been made more compact: 1 slot for 1 to 3 axes. And they are compatible with the A and QnA series PLC's. A high-precision, highly functional positioning unit that uses a 32-bit RISC chip.</p> <table border="1" data-bbox="426 1196 1076 1487"> <thead> <tr> <th>Item \ Model</th> <th>AD75M1 A1SD75M1</th> <th>AD75M2 A1SD75M2</th> <th>AD75M3 A1SD75M3</th> </tr> </thead> <tbody> <tr> <td>Number of control axes</td> <td>1</td> <td>2 simultaneous 2 independent</td> <td>3 simultaneous 3 independent</td> </tr> <tr> <td>Interpolation functions</td> <td>None</td> <td>2-axes linear interpolation 2-axes circular interpolation</td> <td>2-axes linear interpolation 2-axes circular interpolation</td> </tr> <tr> <td>Control mode</td> <td colspan="3">PTP control, locus control, speed control, speed position control</td> </tr> <tr> <td>Command mode</td> <td colspan="3">Incremental, absolute</td> </tr> <tr> <td>Maximum number of output pulses</td> <td colspan="3">±2147483648</td> </tr> <tr> <td>Positioning pattern</td> <td colspan="3">600 patterns/shaft (100 patterns from ladder)</td> </tr> <tr> <td>Input/output duty points</td> <td colspan="3">32</td> </tr> <tr> <td>Acceleration/deceleration patterns</td> <td colspan="3">4, automatic trapezoid, S-acceleration/deceleration</td> </tr> </tbody> </table>	Item \ Model	AD75M1 A1SD75M1	AD75M2 A1SD75M2	AD75M3 A1SD75M3	Number of control axes	1	2 simultaneous 2 independent	3 simultaneous 3 independent	Interpolation functions	None	2-axes linear interpolation 2-axes circular interpolation	2-axes linear interpolation 2-axes circular interpolation	Control mode	PTP control, locus control, speed control, speed position control			Command mode	Incremental, absolute			Maximum number of output pulses	±2147483648			Positioning pattern	600 patterns/shaft (100 patterns from ladder)			Input/output duty points	32			Acceleration/deceleration patterns	4, automatic trapezoid, S-acceleration/deceleration			<p>■ AD75M positioning unit</p>  <p>4.2 (0.17) 111 (4.37) 250 (9.84) 2 (0.08) 108 (4.25) 3 (0.12) 37.5 (1.48)</p> <p>■ A1SD75M positioning unit</p>  <p>6.5 (0.26) 93.6 (3.67) 2.3 (0.09) 34.5 (1.36) 130 (5.12)</p> <p>Unit: mm (inch)</p>
Item \ Model	AD75M1 A1SD75M1	AD75M2 A1SD75M2	AD75M3 A1SD75M3																																			
Number of control axes	1	2 simultaneous 2 independent	3 simultaneous 3 independent																																			
Interpolation functions	None	2-axes linear interpolation 2-axes circular interpolation	2-axes linear interpolation 2-axes circular interpolation																																			
Control mode	PTP control, locus control, speed control, speed position control																																					
Command mode	Incremental, absolute																																					
Maximum number of output pulses	±2147483648																																					
Positioning pattern	600 patterns/shaft (100 patterns from ladder)																																					
Input/output duty points	32																																					
Acceleration/deceleration patterns	4, automatic trapezoid, S-acceleration/deceleration																																					

Using Personal Computers

Capacity selection software

MRZJW3-MOTSZ

A user-friendly design facilitates selection of the optimum servo-amp, servomotor (including brake and decelerator), and optional regenerative devices when you enter constants into machine-specific screens.



Features

- (1) Windows 3.1 and Windows 95^(note 1) Compatible
Works on computers running Windows 3.1 or Windows 95. Requires at least 4 MB of memory and 1 MB of hard disk space.
- (2) Provides numerous structural options. Handles ball screws, rack and pinions, roll feeds, rotating tables, dollies, elevators, conveyors, and other (direct inertial input) devices.
- (3) Easy to convert units. It's easy to calculate and convert in SI, MKS mass, and inch/pound units.

Specifications

Parameter	Description
Types of structural machine elements	Nine types: Horizontal ball screws, vertical ball screws, rack and pinions, roll feeds, rotating tables, dollies, elevators, conveyors, and other (direct inertial input) devices.
Output of results	Parameters Selected servo-amp name, selected servomotor name, selected regenerative resistor name, load inertial moment, load inertial moment ratio, peak torque ratio, effective torque, effective torque ratio, regenerative power, and regenerative power ratio.
	Printing Prints the input parameters, calculation process, and selected results.
	Data storage Gives the input parameters a file name and saves them to a floppy.
Inertial moment calculation function	Five types: centrifugal cylinder, off-axis square shaft, linear motion, hanging, and decelerator.

Notes:

1. Windows is a registered trademark of the Microsoft Corporation.
2. This software may not run correctly on all personal computers.
3. The MRZJW3-MOTSZ41 capacity selection software does not work for MR-J2-C. It will after the next upgrade. Version 41 will work with HC-MF, HA-FF, HC-SF, UF 2000 r/min, and HC-RF series motors.

Using Personal Computers

■ Setup Software

MRJW3-SETUP

This software makes it easy to do monitor display, diagnosis, reading and writing of parameters, and test operations from the setup using a personal computer.

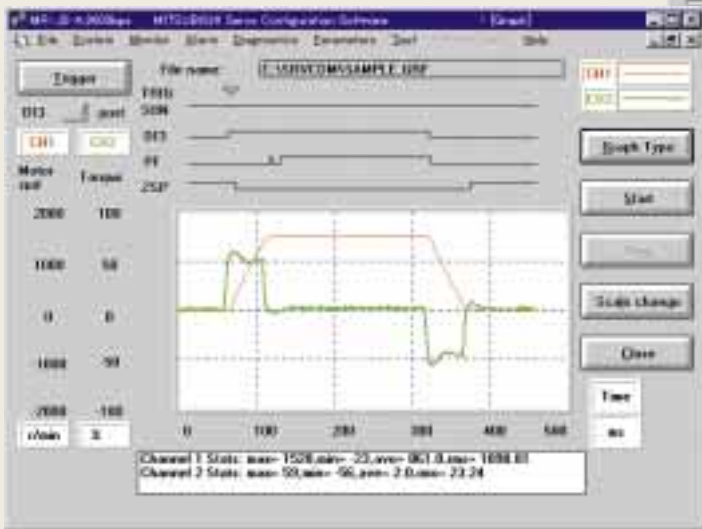

No.	Name	Value	Unit	Setting range
0	Regenerating brake select	0000		0000-0005h
1	Function selection 1	0000		0000-3112h
2	Auto tuning	0102		0000-1215h
3	Com. pulse multiply master	1		1-32767
4	Com. pulse multiply slave	1		1-32767
5	In position range	100	pulse	0-10000
6	Position control gain 1	30	rad/sec	4-1000
7	Pos. com. acc/dec time const.	5	msec	0-20000
8	Internal speed command 1	100	r/min	0-5175
9	Internal speed command 2	500	r/min	0-5175

Features

- (1) Windows 3.1 and Windows 95 (note 1) Compatible
Works on computers running Windows 3.1 or Windows 95. Can be setup using a personal computer instead of the parameter unit. Requires at least 4 MB of memory and 1 MB of hard disk space. Uses a serial port.
- (2) Provides numerous monitor functions. Provides graph display function that enables display of servomotor status upon input signal triggers such as command pulses, accumulated pulses, and r/min.
- (3) Run Tests from a Personal Computer
Allows servo motors to be tested easily from a personal computer.
Specifications (Items in parentheses do not work with the MR-J2)

Specifications (Items in parentheses do not work with the MR-J2)

Parameter	Description
Monitors	Batch display, fast display, and graph display.
Alarms	Alarm display, alarm history, display of data that generated alarm, and (pre-alarm graph display).
Diagnosis	DI/DO display, display of reason motor is not running, (display of recovery time), display of cumulative time power is on, switch number display, tuning data display, ABS data display, and automatic VC offset display. (note 2)
Parameters	Data setting, list displays, display of change lists, display of detailed information, (feed system selection), and device setting. (note 3)
Test operations	JOG operation, positioning operation, operation without motor, forced DO output, program operation using simple language, and (one-step feed (note 3)).
Point data (note 3)	(Position/speed block data batch display, data setting, teaching), and point table. (note 3)
File operation	Data reading, storage, and printing.
Other	Automatic operation and help display.

Notes:

1. Windows is a registered trademark of the Microsoft Corporation.
2. Automatic VC offset display works only with the MR-J2-A series.
3. MR-J2-C compatible.
4. This software may not run correctly on some PCs.

Cautions Concerning Use

To ensure safe use

- To ensure the safe and proper use of the product, we ask that you read the instruction manual prior to its use.
- These products are not designed or manufactured for use in machinery and systems where people's safety is at stake.
- When considering the product for use in such special applications as equipment or systems employed in passenger transportation, medicine, aerospace, nuclear power generation, or underwater relays, please contact our sales representative.
- This product has been manufactured to the most rigorous quality standards. However, we ask that you employ safety devices when using the product in equipment in which any failure on its part can be expected to cause a serious accident or loss.

Cautions concerning use

Transport and installation of motor

- Protect the motor from impact during handling. When installing pulleys and couplings, do not hammer on the shaft. Impact can damage the encoder. Use a pulley extractor when taking off the pulley.



Installation

- Avoid installation in an environment in which oil mist, dust, etc. are in the air. When using in such an environment, enclose the servo-amp in an airtight panel. Protect the motor by furnishing a cover for it or taking similar measures.
- Mount the amp vertically on a wall.
- When installing multiple amps inside an airtight panel, leave at least 10 millimeters between amps. Leave at least 40 millimeters of space above and below the amp. When installing multiple amps, leave 100 millimeters of space or install a fan to ensure that heat is not trapped inside the panel.

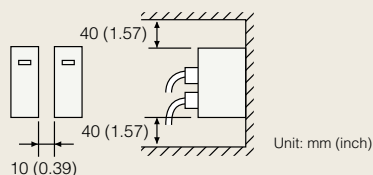

- While installing a single motor, the motor can be installed horizontally or vertically. When installing vertical (upside the shaft) take measures on the machine side to ensure that oil from the gear box does not get into the motor.
- The optional regeneration unit becomes hot (temperature rise of 100°C or more) with frequent use. Do not install within flammable objects or objects subject to thermal deformation. Take care to ensure that electric wires do not come into contact with the main unit.

Wiring

- A power supply to the amp's output terminal (U, V, W) will damage the amp. Before switching the power on, perform thorough wiring and sequence checks to ensure that there are no wiring errors, etc.
- Connecting wall out-let onto the motor's input terminal (U, V, W) will burn out the motor. Connect the motor to the amp's output terminal (U, V, W).
- Match the phase of the motor input terminal (U, V, W) to the output terminal (U, V, W) before connecting. If they are not the same, motor control cannot be performed.
- In position control mode, connect the stroke end signal (LSP, LSN) to the common terminal (SG). If it is not connected, the motor will not rotate.

Factory settings

- All possible motor and amp combinations are predetermined. Confirm the model of the motor and amp to be used before installation.
- Position, speed, and torque control modes are selected with parameter 0. The factory setting is position control mode. For speed operation, change this setting.
- When using the optional regeneration unit, change parameter 0. The factory setting is for no optional regeneration unit. Therefore, if this parameter is not changed, the unit's capacity will not be increased.

Operation

- When a magnetic contactor (MC) is installed on the amp's primary side, do not perform frequent starts and stops with the MC. Doing so could cause the amp to fail.
- When an error occurs, the amp's safety features are activated, halting output, and the dynamic brake instantly stops the motor. If free run is required, contact Mitsubishi about solutions involving servo-amps where the dynamic brake is not activated.
- When using a motor with an electromagnetic brake, do not apply the brake when the servo is on. Doing so could cause an amp overload or shorten brake life. Apply the brake when the servo is off.

Cautions concerning model selection

- Select a motor with a rated torque above the continuous effective load torque.
- Design the operation pattern so that positioning can be completed, taking into account the setting time (t_s).

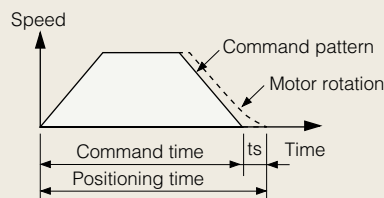

- Use the unit with the load's inertia set below the recommended load/inertia ratio of the motor being used. If it is too large, desired performance may not be attainable.

Example of Selection

Example of selection

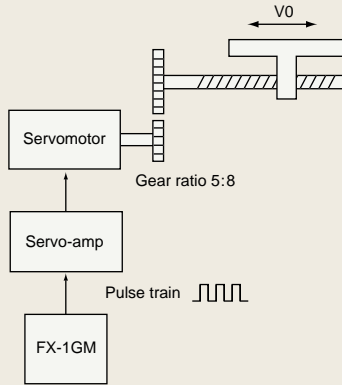

Speed of moving parts during fast forward: $V_0=30000\text{mm/min}$
 Feed per pulse: $\Delta \ell = 0.005\text{mm}$ (0.0002 inch)
 Feed per rotation: $\ell = 400\text{mm}$ (15.75 inch)
 Positioning time: $t_0 = 0.9\text{ sec}$ or less
 Number of feeds: 40/min
 (Operating period: $t_1 = 1.5\text{ sec}$)
 Gear ratio: $n=8/5$
 Weight of moving parts: $W=60\text{kg}$ (132 lb)
 Drive system efficiency: $\eta=0.8$
 Friction coefficient: $\mu=0.2$
 Ball screw lead: $P_B=16\text{mm}$ (0.63 inch)

D_B = Ball screw diameter: 20 mm (0.78 inch)
 L_B = Ball screw length: 500 mm (19.69 inch)
 D_{G1} = Gear diameter (motor axis): 25 mm (0.98 inch)
 D_{G2} = Gear diameter (load axis): 40 mm (1.57 inch)
 L_G = Gear tooth thickness: 10 mm (0.39 inch)

(1) Select control parameters

- a. Set electronic gear (pulse multiplication denominator and numerator)
 The following relationship is established between the multiplication setting and the amount of movement $\Delta \ell$ per input pulse.

$$\Delta \ell = \frac{\text{Ball screw lead}}{8192 \times (\text{Gear ratio})} \times \left(\frac{\text{CMX}}{\text{CDV}} \right)$$

Substituting the machine specifications given above into this equation:

$$\frac{\text{CMX}}{\text{CDV}} = 0.005 \times \frac{8192 \times 8/5}{16} = \frac{512}{125}$$

OK if the ratio $\frac{\text{CMX}}{\text{CDV}}$ is between 1/50 and 50.

- b. Input pulse string frequency f_0 during fast forward

$$f_0 = \frac{V_0}{60 \times \Delta \ell} = \frac{30000}{60 \times 0.005} = 100000 \text{ pps}$$

OK if f_0 is 200 kpps or less

(2) Motor speed

$$N_0 = \frac{V_0}{P_B} \cdot n = 3000 \text{ r/min}$$

(3) Acceleration/Deceleration time constant

$$T_{psa} = T_{psd} = t_0 - \frac{\ell}{V_0/60} - t_s = 0.05 \text{ sec.}$$

* t_s is the stop recovery time. Estimated here at 0.05 sec for fast response.

(4) Operating pattern

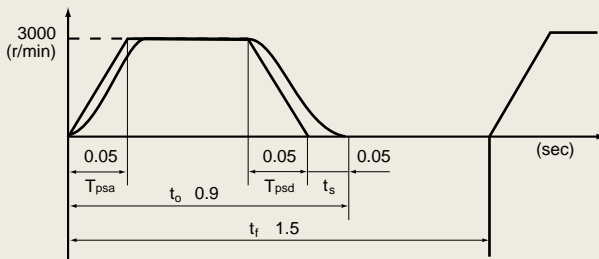

(5) Load torque (motor axis equivalent)

Amount of movement per motor rotation

$$\Delta S = P_B \times \frac{1}{n} = 10\text{mm}$$
 (0.39 inch)

For conventional unit system

$$T_L = \frac{\mu \cdot W \cdot g \cdot \Delta S}{2 \times 10^3 \pi \eta} = 0.23\text{N} \cdot \text{m}$$

$$T_L = \frac{\mu W \cdot \Delta S}{20 \pi \eta} = 2.4 \text{ kgf} \cdot \text{cm}$$

(6) Load inertial moment (motor axis equivalent)

Moving parts

$$J_{L1} = W \cdot \left(\frac{\Delta S}{20 \pi} \right)^2 = 1.52 \text{ kg} \cdot \text{cm}^2$$

Ball screw

$$J_{L2} = \frac{\pi \cdot \rho \cdot L}{32} \cdot D^2 \cdot \left(\frac{1}{n} \right)^2 = 0.24 \text{ kg} \cdot \text{cm}^2$$

* $\rho = 7.8 \cdot 10 \text{ kg} \cdot \text{cm}^2$ (Iron)

Gear (motor axis)

$$J_{L3} = \frac{\pi \cdot \rho \cdot L}{32} \cdot D^3 = 0.03 \text{ kg} \cdot \text{cm}^2$$

Gear (load axis)

$$J_{L4} = \frac{\pi \cdot \rho \cdot L}{32} \cdot D^4 \cdot \left(\frac{1}{n} \right)^2 = 0.08 \text{ kg} \cdot \text{cm}^2$$

Total load inertial moment (motor axis equivalent)

$$J_L = J_{L1} + J_{L2} + J_{L3} + J_{L4} = 1.9 \text{ kg} \cdot \text{cm}^2$$

For conventional unit system

$$GD_L^2 = 4 \times J = 7.6 \text{ kgf} \cdot \text{cm}^2$$

(7) Provisional motor selection

Selection conditions. HC-MF23 (200 W) provisionally selected from:

- Load torque < Rated motor torque
- Load inertial moment < $30 \times$ motor inertial moment

(8) Acceleration and deceleration torque

Required motor torque during acceleration

$$T_{Ma} = \frac{(J_L + J_M) \times N_0}{9.55 \times 10^4 \times T_{psa}} + T_L = 1.48\text{N} \cdot \text{m}$$

For conventional unit system

$$T_{Ma} = \frac{(GD_L^2 + GD_M^2) \times N_0}{37500 \times T_{psa}} + T_L = 15.1 \text{ kgf} \cdot \text{cm}$$

Required motor torque during deceleration

$$T_{Md} = \frac{(J_L + J_M) \times N_0}{9.55 \times 10^4 \times T_{psd}} + T_L = 1.02\text{N} \cdot \text{m}$$

$$T_{Md} = \frac{(GD_L^2 + GD_M^2) \times N_0}{37500 \times T_{psd}} + T_L = -10.3 \text{ kgf} \cdot \text{cm}$$

The required motor torque during acceleration and deceleration shall be at or below maximum motor torque.

(9) Continuous effective load torque

$$T_{rms} = \sqrt{\frac{T_{Ma}^2 \times T_{psa} + T_L^2 \times t_c \times T_{Md}^2 \times T_{psd}}{t_f}} = 0.37\text{N} \cdot \text{m}$$

For conventional unit system

$$3.7 \text{ kgf} \cdot \text{cm}$$

* $t_c = t_0 - t_s - 2 \times T_{psa}$

The continuous effective load torque shall be at or below maximum torque.

(10) Torque pattern

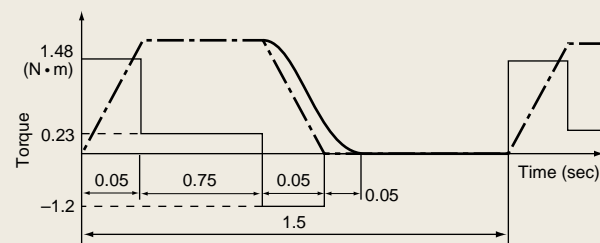

(11) Selection results

From the above, servomotor HF-MF23 is selected.

Servo-amp MR-J2-20A

a. Parameter settings

Command pulse multiplication numerator (CMX)	512
Command pulse multiplication denominator (CDV)	125

b. During fast forward

- Motor r/min: $N_0 = 3000 \text{ r/min}$
- Input pulse string frequency $f_0 = 100 \text{ kpps}$

c. Acceleration/deceleration time constant

$$T_{psa} = T_{psd} = 0.05 \text{ sec}$$



- COMPOSANTS D'AUTOMATISME
- SYSTEMES D'AUTOMATISME
- CONSTITUANTS ELECTROTECHNIQUES
- MESURE ET CONTROLE
- SECURITE MACHINE

8, Avenue de la Malle - ZI Les Coïdes
51370 SAINT BRICE COURCELLES
Tél. : 03.26.04.20.21 - Fax : 03.26.04.28.20
Email : info@audin.fr - Web : <http://www.audin.fr>

 **Safety Warning**

To ensure proper use of the products listed in this catalog,
please be sure to read the instruction manual prior to use.

 **MITSUBISHI ELECTRIC CORPORATION**
HEAD OFFICE: MITSUBISHI DENKI BLDG., 2-2-3, MARUNOUCHI, CHIYODA-KU, TOKYO 100-8310, JAPAN