

## Mechanical Indicators Added as a Standard Feature to Our Best-selling MY General-purpose Relays

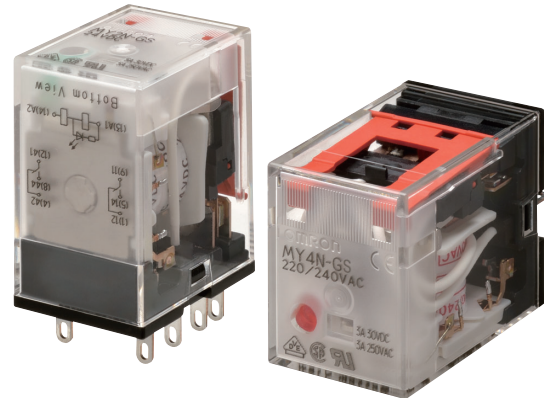

- Relays with AC and DC coils have different colors of operating indicators (LEDs).
- Printing on the coil tape indicates the operating coil specification.
- Mechanical operation indicators are a standard feature on all models.
- RoHS compliant.
- UL, CSA, and IEC (VDE certification).



Refer to the *Common Relay Precautions*.

## Features

- Mechanical indicators are a standard feature on all models so that you can easily check the contact status.
- The color of the LED shows whether the coil voltage is AC or DC.

Mechanical indicators  
(one on left and one on right)

Contacts ON (coil energized)

Contacts OFF (coil de-energized)

LED operation indicator  
Relay with AC coil: Red  
Relay with DC coil: Green



Relay with AC Coil (LED: Red)



Relay with AC Coil (LED: Red)



Relay with DC Coil (LED: Green)

## Model Number Structure

### Model Number Legend

MY □ □ -GS DC24

1      2                                      3

1. Number of Poles  
2: 2 poles  
4: 4 poles
2. LED Operation Indicator  
Blank: Built-in mechanical indicators  
N: LED operation indicator and built-in mechanical indicators
3. Operating Coil Voltage  
Display Example: DC24V

## Ordering Information

### List of Models

Category	Contact configuration	Model	Rated voltage (V)
Standard models	DPDT	MY2-GS	24 VAC, 100/110 VAC, 200/220 VAC, or 220/240 VAC 24 VDC
	4PDT	MY4-GS	24 VAC, 100/110 VAC, 200/220 VAC, or 220/240 VAC 24 VDC
Models with built-in LED operation indicators	DPDT	MY2N-GS	24 VAC, 100/110 VAC, 200/220 VAC, or 220/240 VAC 24 VDC
	4PDT	MY4N-GS	24 VAC, 100/110 VAC, 200/220 VAC, or 220/240 VAC 24 VDC

### Accessories (Order Separately)

#### Connection Sockets and Hold-down Clips

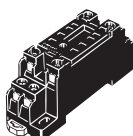
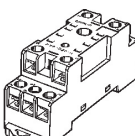
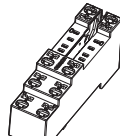
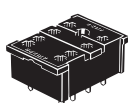
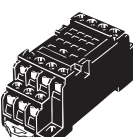
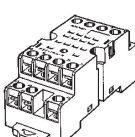
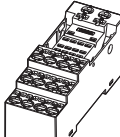
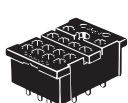
Mounting	Front-mounting Sockets			Back-mounting Sockets
	DIN Track or screw mounting		DIN Track mounting	PCB mounting
	Screw connections		Screwless connections	Soldered connections
Wiring				
MY2-GS MY2N-GS	PYF08A-E 	PYF08A-N 	PYF08S 	PY08-02 
	PYF14A-E 	PYF14A-N 	PYF14S 	PY14-02 
Hold-down Clips	PYC-A1		PYCM-08S or PYCM-14S	PYC-P

## Ratings and Specifications

### Ratings

#### Operating Coil

Item	Rated current (mA)	Coil resistance (Ω)		Coil inductance (H)		Must-operate voltage	Must-release voltage	Maximum voltage	Power consumption (VA, W)
		50 Hz	60 Hz	Armature OFF	Armature ON				
AC	24	53.8	46	180	0.69	80% max. <sup>*1</sup>	30% min. <sup>*2</sup>	110%	Approx. 1.1 (at 60 Hz)
	100/110	11.7/12.9	10.0/11.0	3,750	14.54				
	200/220	6.2/6.8	5.3/5.8	12,950	54.75				
	220/240	5.2/6.2	4.3/5.0	15,920	83.5				
DC	24	36.3 (37.7)		662 (636)	3.2		10% min. <sup>*2</sup>		Approx. 0.9

**Note:** 1. The rated current and coil resistance are measured at a coil temperature of 23°C with tolerances of +15%/–20% for the AC rated current and +15% for the DC coil resistance.

2. The AC coil resistance and inductance values are reference values only (at 60 Hz).

3. Operating characteristics were measured at a coil temperature of 23°C.

4. The values in parentheses for the rated currents and coil voltages of DC coils are for models with LED operation indicators.

5. The maximum voltage capacity was measured at an ambient temperature of 23°C.

\*1. There is variation between products, but actual values are 80% max.

The Relay will operate if 80% or higher of the rated voltage is applied. However, to achieve the specified characteristics, apply the rated voltage to the coil.

\*2. There is variation between products, but actual values are 30% minimum for AC and 10% minimum for DC. To ensure release, use a value that is lower than the specified value.

## Contacts

	2 poles		4 poles	
	Resistive load	Inductive load ( $\cos \phi = 0.4$ , $L/R = 7$ ms)	Resistive load	Inductive load ( $\cos \phi = 0.4$ , $L/R = 7$ ms)
<b>Contact configuration</b>	DPDT		4PDT	
<b>Contact structure</b>	Single			
<b>Contact material</b>	Ag			
<b>Rated load</b>	5 A at 220 VAC 5 A at 24 VDC	2 A at 220 VAC 2 A at 24 VDC	3 A at 220 VAC 3 A at 24 VDC	0.8 A at 220 VAC 1.5 A at 24 VDC
<b>Rated carry current</b>	5 A		3 A	
<b>Maximum contact voltage</b>	250 VAC, 125 VDC		250 VAC, 125 VDC	
<b>Maximum contact current</b>	5 A		3 A	
<b>Maximum switching capacity</b>	1,100 VA 120 W	440 VA 48 W	660 VA 72 W	176 VA 36 W
<b>Minimum load (reference values)*</b>	1 mA at 5 VDC			

\* These values are guides for the switchable limits for minute load levels, such as in electronic circuits. Actual characteristics may be different. These values will depend on the switching frequency, atmosphere, and expected reliability level. Confirm applicability in the actual system under actual application conditions.

## Characteristics

		2 poles	4 poles
<b>Contact resistance *1</b>		100 m $\Omega$ max.	
<b>Operation time *2</b>		20 ms max.	
<b>Release time *2</b>		20 ms max.	
<b>Maximum operating frequency</b>	Mechanical	18,000 operations/h	
	Rated load	2,400 operations/h	
<b>Insulation resistance *3</b>		1,000 M $\Omega$ min.	
<b>Dielectric strength</b>	Between coil and contacts	2,000 VAC at 50/60 Hz for 1 min.	
	Between contacts of different polarity	2,000 VAC at 50/60 Hz for 1 min.	
	Between contacts of the same polarity	1,000 VAC at 50/60 Hz for 1 min.	
<b>Vibration resistance</b>	Destruction	10 to 55 to 10 Hz, Double amplitude: 1.0 mm	
	Malfunction	10 to 55 to 10 Hz, Double amplitude: 1.0 mm	
<b>Shock resistance</b>	Destruction	1,000 m/s <sup>2</sup> (approx. 100 G)	
	Malfunction	200 m/s <sup>2</sup> (Approx. 20 G)	
<b>Endurance</b>	Mechanical	50,000,000 operations (switching frequency: 18,000 operations/h)	
	Electrical *4	500,000 operations (switching frequency: 2,400 operations/h)	200,000 operations (switching frequency: 2,400 operations/h)
<b>Ambient operating temperature</b>		Standard models: -55 to 70°C (with no icing or condensation) Models with LED operation indicators: -40 to 70°C (with no icing or condensation)	
<b>Ambient humidity</b>		5% to 85%	
<b>Weight</b>		Approx. 35 g	

**Note:** The above values are initial values.

\*1. Measurement conditions: 1 A at 5 VDC using the voltage drop method.

\*2. Measurement conditions: With rated operating power applied, not including contact bounce time.

\*3. Measurement conditions: For 500 VDC applied to the same location as for dielectric strength measurement.

\*4. Ambient temperature condition: 23°C

Duty ratio: 33%

## Certified Ratings for Models Certified for Safety Standards

The rated values for safety standard certification are not the same as individually defined performance values. Always check the specifications before use.

### UL-certified Models: UL508

MY-GS	Number of poles	Coil ratings	Contact ratings	Certified number of operations
	2	24 VAC, 100/110 VAC, 200/220 VAC, 220/240 VAC, or 24 VDC	5 A, 30 VDC (General Use) 5 A, 250 VAC (General Use)	6,000 operations
	4	24 VAC, 100/110 VAC, 200/220 VAC, 220/240 VAC, or 24 VDC	3 A, 30 VDC (General Use) 3 A, 250 VAC (General Use)	6,000 operations

### CSA-certified Models: CSA C22.2 No.14

MY-GS	Number of poles	Coil ratings	Contact ratings	Certified number of operations
	2	24 VAC, 100/110 VAC, 200/220 VAC, 220/240 VAC, or 24 VDC	5 A, 30 VDC (General Use) 5 A, 250 VAC (General Use)	6,000 operations
	4	24 VAC, 100/110 VAC, 200/220 VAC, 220/240 VAC, or 24 VDC	3 A, 30 VDC (General Use) 3 A, 250 VAC (General Use)	6,000 operations

### VDE-certified Models: EN 61810-1

MY-GS	Number of poles	Coil ratings	Contact ratings	Certified number of operations
	2	24 VAC, 100/110 VAC, 200/220 VAC, 220/240 VAC, or 24 VDC	5 A, 30 VDC (L/R = 1) 5 A, 250 VAC (cos $\phi$ = 1)	10,000 operations
	4	24 VAC, 100/110 VAC, 200/220 VAC, 220/240 VAC, or 24 VDC	3 A, 30 VDC (L/R = 1) 3 A, 250 VAC (cos $\phi$ = 1)	10,000 operations

# Engineering Data

## Reference Data

### Maximum Switching Capacity

#### MY2-GS

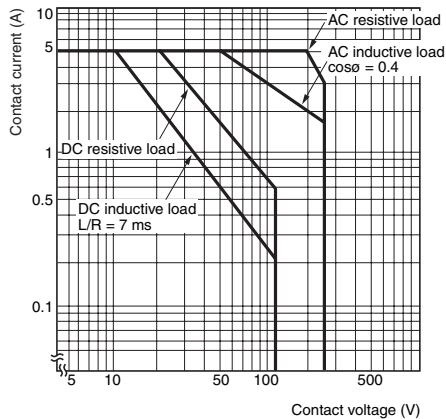

#### MY4-GS

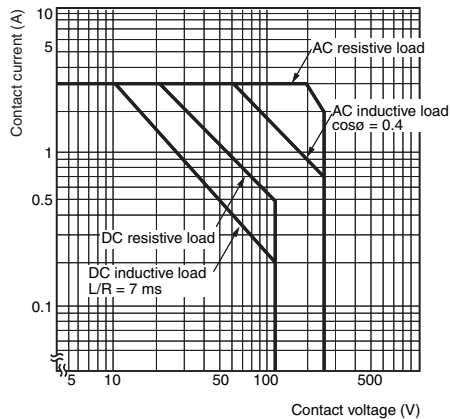

### Endurance Curve

#### MY2-GS (Resistive Load)

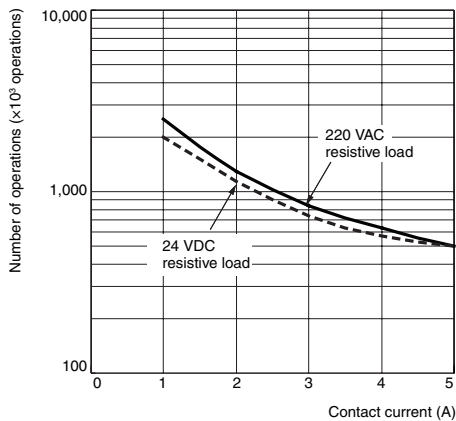

#### MY2-GS (Inductive Load)

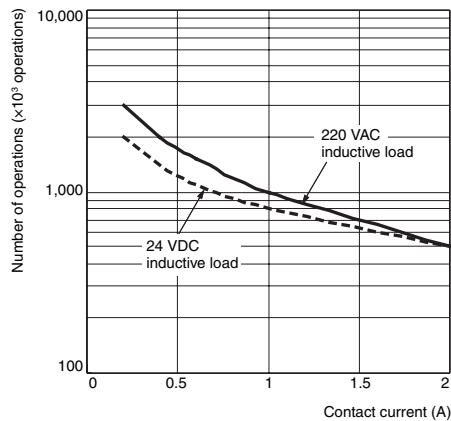

#### MY4-GS (Resistive Load)

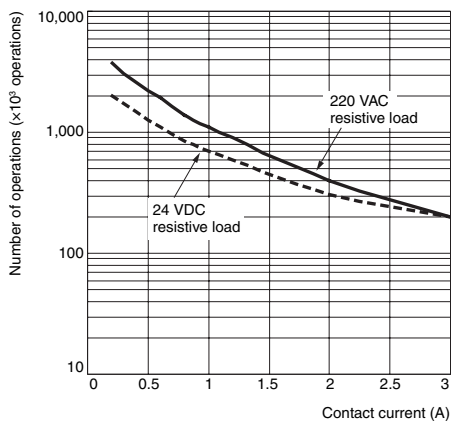

#### MY4-GS (Inductive Load)

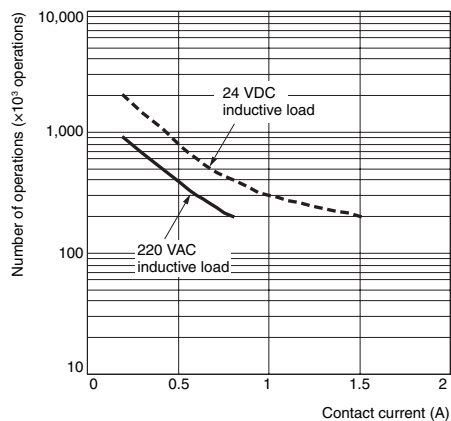

**Note:** 1. Number of operations: AC load, 50 Hz, 80%  
 2. Switching condition: NO or NC

**Ambient Temperature vs. Must-operate and Must-release Voltage**

**MY2-GS AC Models**

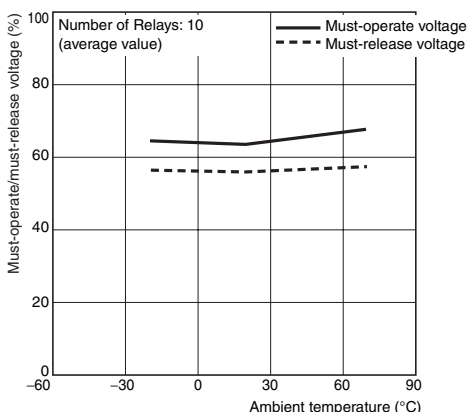

**MY2-GS DC Models**

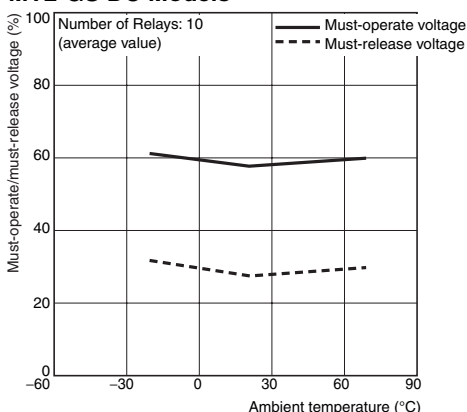

**MY4-GS AC Models**

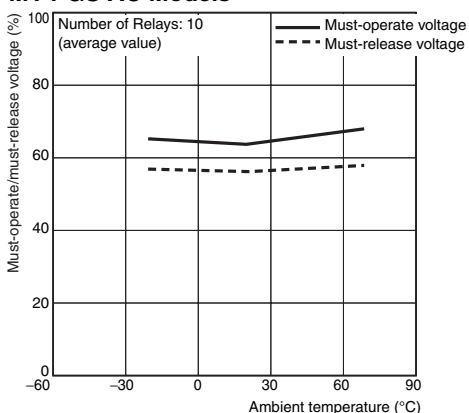

**MY4-GS DC Models**

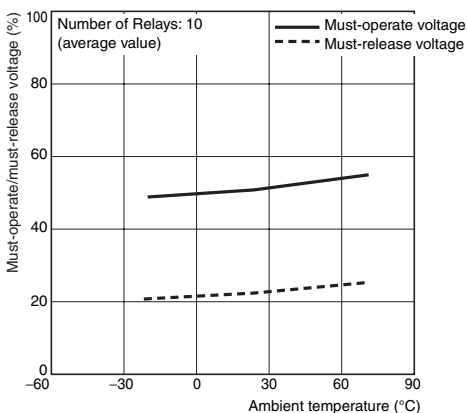

**Ambient Temperature vs. Coil Temperature Rise**

**MY2-GS AC Models, 50 Hz**

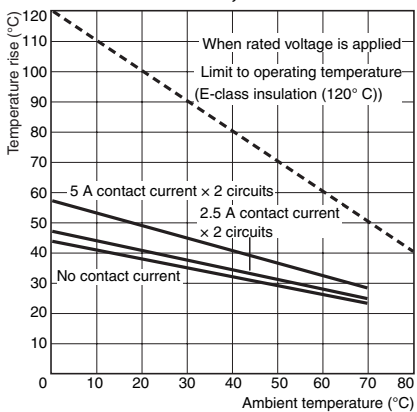

**MY2-GS DC Models**

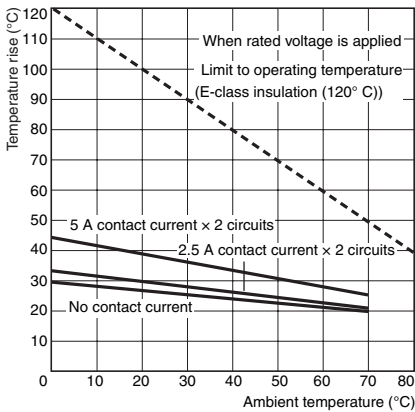

**MY4-GS AC Models, 50 Hz**

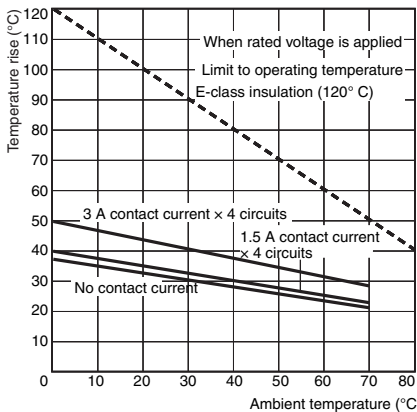

**MY4-GS DC Models**

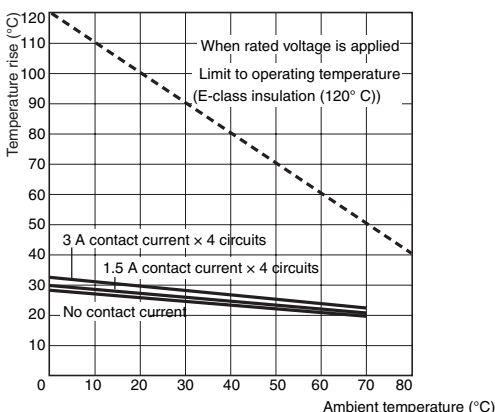

# Dimensions

## Relays

### MY2-GS and MY2N-GS

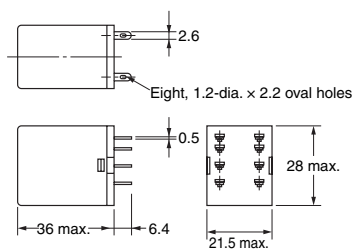

Terminal Arrangement/Internal Connections (Bottom View) Standard Models

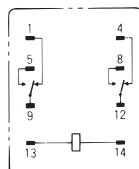

(The coil has no polarity.)

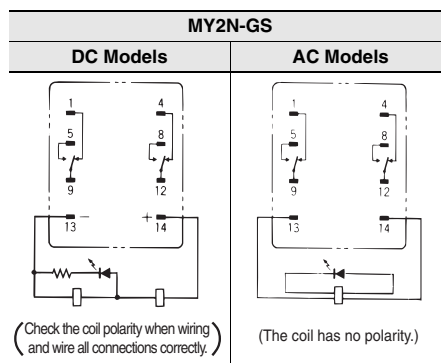

- Note:**
1. An AC model has coil disconnection self-diagnosis.
  2. For the DC models, check the coil polarity when wiring and wire all connections correctly.
  3. The indicator is red for AC and green for DC.
  4. The LED operation indicators indicate the energization of the coil and do not necessarily represent contact operation.

### MY4-GS and MY4N-GS

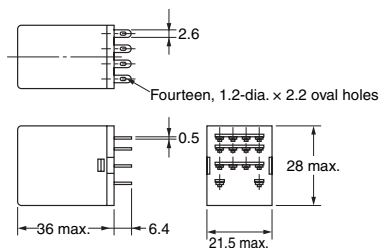

Terminal Arrangement/Internal Connections (Bottom View) Standard Models

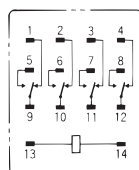

(The coil has no polarity.)

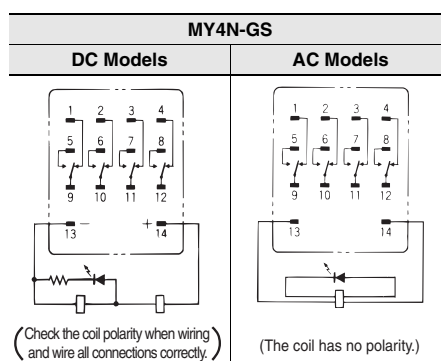

- Note:**
1. An AC model has coil disconnection self-diagnosis.
  2. For the DC models, check the coil polarity when wiring and wire all connections correctly.
  3. The indicator is red for AC and green for DC.
  4. The LED operation indicators indicate the energization of the coil and do not necessarily represent contact operation.

## Options (Order Separately)

Refer to *Common Socket and DIN Track Products* for details on Connection Sockets and DIN Track products (sold separately).

## Connection Sockets

### Front-mounting Sockets

#### PYF08A-E

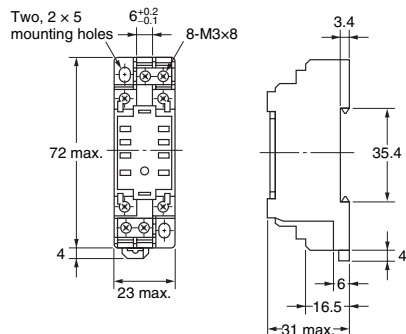
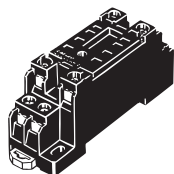

Terminal Arrangement/  
Internal Connections  
(Top View)

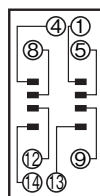

Mounting Hole  
Dimensions (Top View)

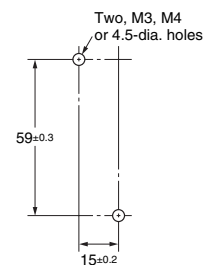

Note: Mounts to DIN Track.

#### PYF14A-E

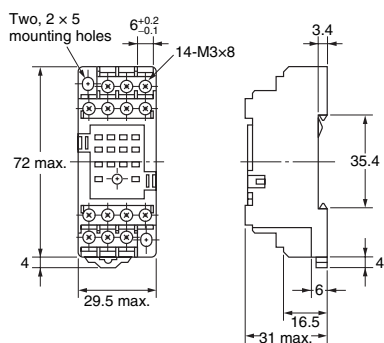
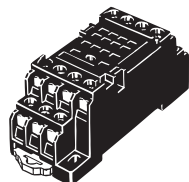

Terminal Arrangement/  
Internal Connections  
(Top View)

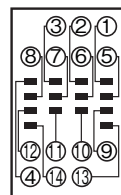

Mounting Hole  
Dimensions (Top View)

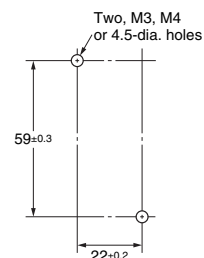

Note: Mounts to DIN Track.

#### PYF08A-N

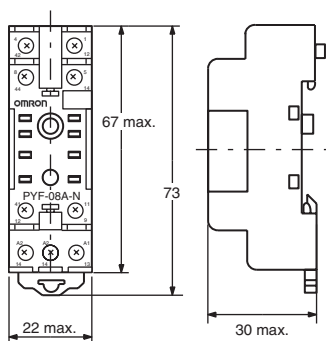
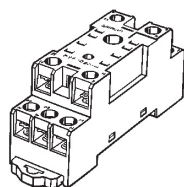

Terminal Arrangement/  
Internal Connections  
(Top View)

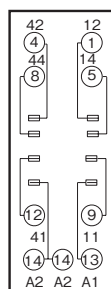

Mounting Hole  
Dimensions (Top View)

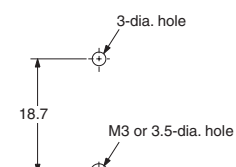

Note: Mounts to DIN Track.

#### PYF14A-N

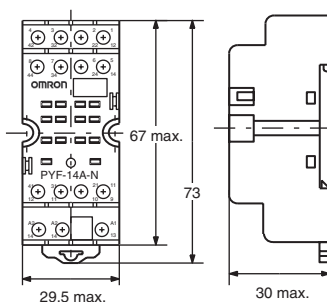
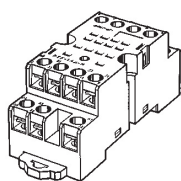

Terminal Arrangement/  
Internal Connections  
(Top View)

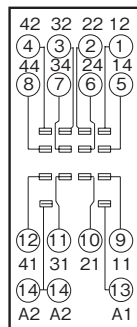

Mounting Hole  
Dimensions (Top View)

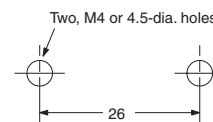

Note: Mounts to DIN Track.



**PYF08S**

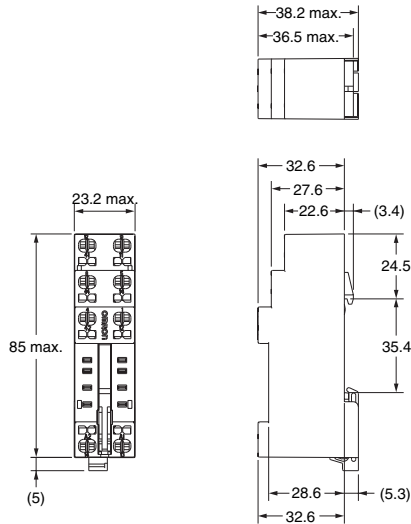
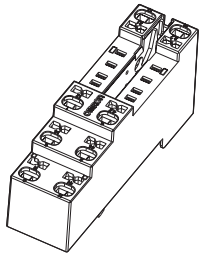

**Terminal Arrangement/  
Internal Connections  
(Top View)**

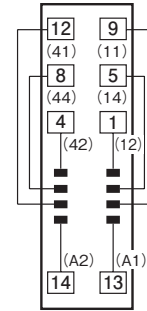

**Note:** Numbers in parentheses are the DIN standard numbers.

**PYF14S**

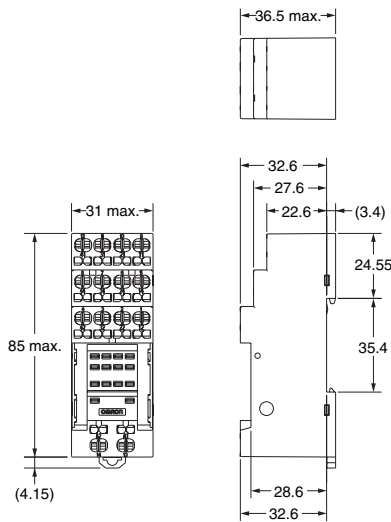
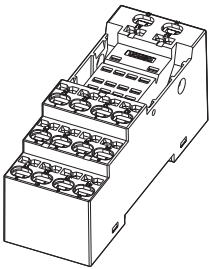

**Terminal Arrangement/  
Internal Connections  
(Top View)**

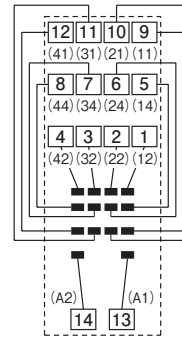

**Note:** Numbers in parentheses are the DIN standard numbers.

**Back-mounting Sockets**

**PY08-02**

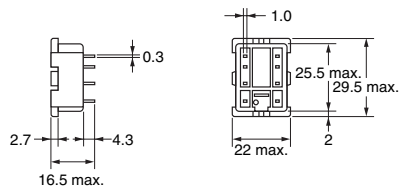
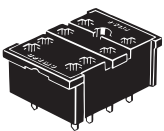

**Terminal Arrangement/  
Internal Connections  
(Bottom View)**

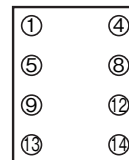

**PCB Processing  
Dimensions**

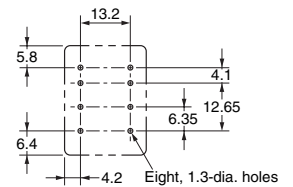

**PY14-02**

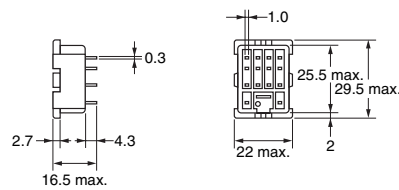
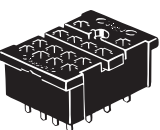

**Terminal Arrangement/  
Internal Connections  
(Bottom View)**

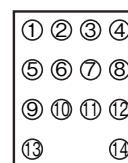

**PCB Processing  
Dimensions**

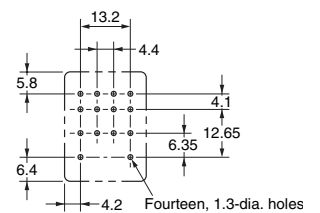

## Accessories

### Hold-down Clips

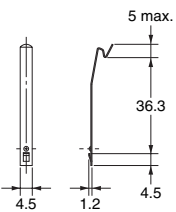
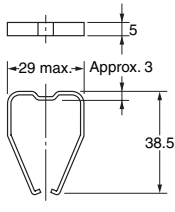
Socket model	PYF08A-E PYF14A-E PYF08A-N PYF14A-N	PY08-02 PY14-02
Relay model	PYC-A1 Set of 2 clips	PYC-P
MY2-GS MY2N-GS MY4-GS MY4N-GS		

### Release Levers

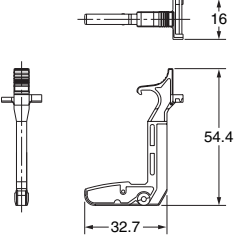
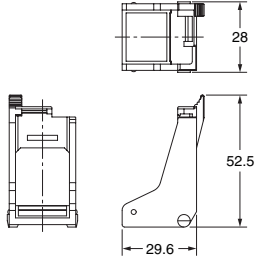
Socket model	PYF08S	PYF14S
Relay model	PYCM-08S	PYCM-14S
MY2-GS MY2N-GS MY4-GS MY4N-GS		

## Mounting Heights with Sockets (Unit: mm)

### Front-mounting Sockets

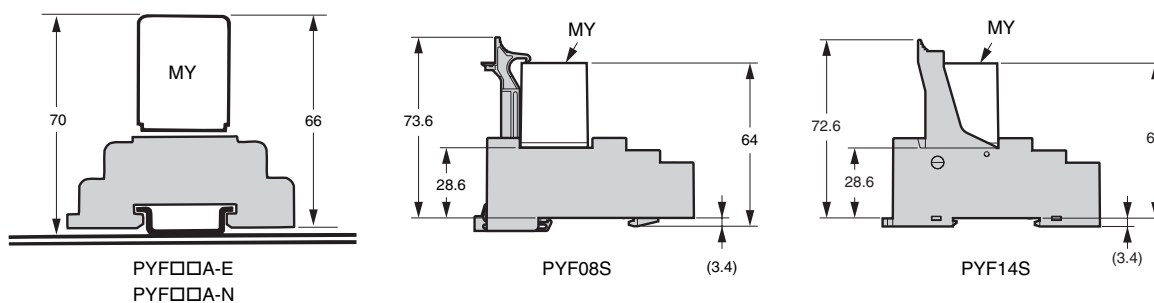

### Back-mounting Sockets

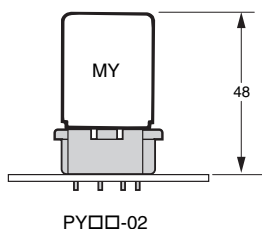

**Note:** The PYF□□A-E and PYF□□A-N can be mounted on a DIN Track or with screws.

## Safety Precautions

---

Refer to the *Common Relay Precautions* for precautions that apply to all Relays.

<b>Precautions for Correct Use</b>
------------------------------------

### Handling

For models with built-in LED operation indicators, check the coil polarity when wiring and wire all connections correctly. (DC operation).

### Installation

There is no specifically required installation orientation, but make sure that the Relays are installed so that the contacts are not subjected to vibration or shock in their movement direction.

### Using MY-GS Relays with Microloads with Infrequent Operation

If standard MYGS Relays are used to infrequently switch microloads, the contacts may become unstable and eventually result in poor contact. In this case, we recommend using the MY4Z-CBG Series, which has high contact reliability for microloads

### Relay Replacement

To replace the Relay, turn OFF the power supply to the load and Relay coil sides to prevent unintended operation and possible electrical shock.

### Applicable Sockets

Use only combinations of OMRON Relays and Sockets.