





















Ø22mm TW Series









Control Units





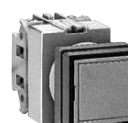



ø22 TW Series Control Units (Selection Guides)



















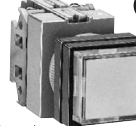

Function	Pushbutton				
	Flush	Extended	Extended w/Full Shroud	ø29mm Mushroom	ø40mm Mushroom
Category	Momentary/Maintained				
Shape	 	 	 	 	 
Type	ABW1 AOW1	ABW2 AOW2	ABFW2 AOFW2	ABW3 AOW3	ABW4 AOW4
Page	8	8	8	8	9









Function	Pushbutton				
	ø40mm Mushroom w/Full Shroud	ø29mm Mushroom	ø40mm Mushroom	ø40mm Mushroom	ø29mm Mushroom
Category	Momentary	Pushlock Turn Reset	Pushlock Turn Reset	Push Turn Lock	Pushlock Key Reset
Shape	 	 	 	 	 
Type	ABGW4	AVW3	AVW4	AJW4	AXW3
Page	9	9	9	9	9

















Function	Pushbutton			
	ø40mm Mushroom Pushlock Key Reset	ø40mm Mushroom Push Pull	Square Flush Momentary/Maintained	Square Extended Momentary/Maintained
Category				
Shape	 	 	 	 
Type	AXW4	AYW4	ABQW1 AOQW1	ABQW2 AOQW2
Page	10	10	10	10

Function	Pilot Light		
	Flush (Non-marking/Marking)	Dome	Square Flush (Marking)
Category			
Shape	 	 	 
Type	APW1 APW1B	APW2	UPQW1B
Page	11	11	11

TW Series Control Units (Selection Guides) Ø22

Function	Illuminated Pushbutton (LED/Incandescent)				
Category	Extended (Non-marking/Marking)	Extended w/Full Shroud (Non-marking/Marking)	Square Extended (Marking)	Ø29mm Mushroom Pushlock Turn Reset	Ø40mm Mushroom Pushlock Turn Reset
Shape	   	   	   	   	   
Type	ALW2, ALW2B, AOLW2, AOLW2B	ALFW2, AOLFW2 ALFW2B, AOLFW2B	ALQW2B AOLQW2B	AVLW3 AVLW3B	AVLW4 AVLW4B
Page	13, 14	15, 16	17	18	19

Function	Illuminated Pushbutton (Incandescent)	
Category	Ø29mm Mushroom (Non-marking/Marking)	Ø40mm Push-Pull
Shape	   	   
Type	ALW3, ALW3B, AOLW3, AOLW3B	AYLW4 AYLW4B
Page	18	19

Function	Selector Switch			Illuminated Selector Switch (LED/Incandescent)
Category	Knob	Lever	Key	Knob
Shape	   	   	   	   
Type	ASW	ASW*L	ASW*K	ASLW
Page	22	23	24	25, 26

Ø22 TW Series Control Units

General-purpose control units for various applications
Heavy-duty type for high-level protection against harsh environment

Low Voltage Directive
 EMC Directive



- Highly reliable HW contact blocks are used.
- Degree of protection: IP65 (IEC 60529)
- UL and CSA approved, EN compliant

Safety Standards	File No. or Organization
UL	UL Listing File No. E68961
CSA	File No. LR21451
EN EN60947-1 EN60947-5-1	TÜV Rheinland

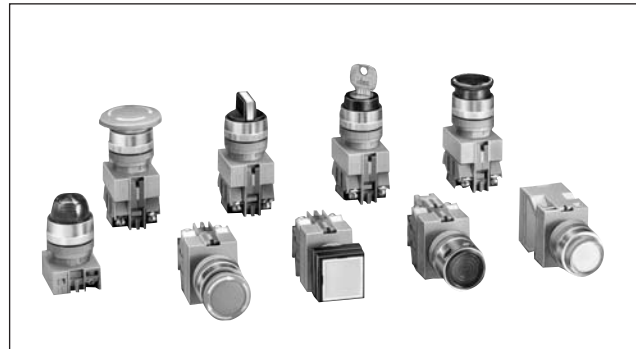

Specifications and Ratings

Contact Ratings

Contact Block	Rated Insulation Voltage	600V
	Rated Continuous Current	10A
	Contact Ratings by Utilization Category IEC 60947-5-1	AC-15 (A600) DC-13 (P600)

Characteristics

• Contact Ratings by Utilization Category

Operational Voltage			24V	48V	50V	110V	220V	440V
Operational Current	AC 50/60 Hz	AC-12 Control of resistive loads and solid state loads	10A	—	10A	10A	6A	2A
		AC-15 Control of electromagnetic loads (> 72 VA)	10A	—	7A	5A	3A	1A
	DC	DC-12 Control of resistive loads and solid state loads	8A	4A	—	2.2A	1.1A	—
		DC-13 Control of electromagnets	4A	2A	—	1.1A	0.6A	—

Minimum applicable load: 3V AC/DC, 5 mA (applicable range may vary with operating conditions and load types)

For the control units listed below, the rated current (load switching current) is reduced to a half of the rated operational current of the contact block. The rated insulation voltage (600V) and the rated thermal current (10A) remain unchanged.

- Selector switches and illuminated selector switches with contact code 2S, 3S, 4S, 2R, or 4R.

HW-C (Contact Block)

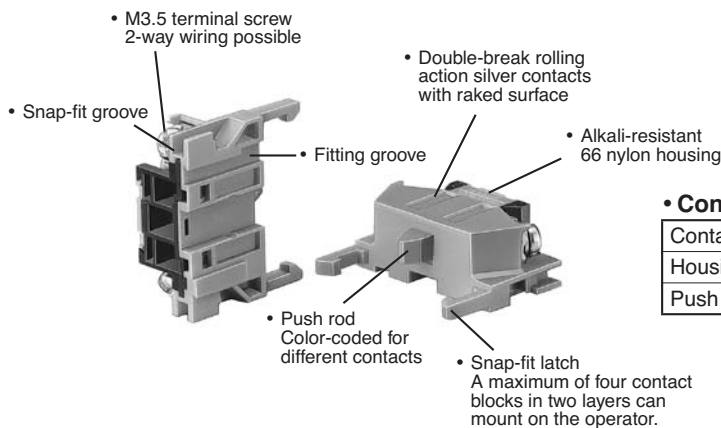

• Contact Block Types

Contact	NO	NC	NO (early make)	NC (late break)
Housing	Blue	Purple red	Blue	Purple red
Push Rod	Green	Red	Black	White

Incandescent Lamp Ratings (LS Type)

Type No.	LS-6	LS-8	LS-2	LS-3
Lamp Base	BA9S/13			
Rated Voltage	6V AC/DC	12V AC/DC	18V AC/DC	24V AC/DC
Wattage	1W (6.3V)	1W (18V)	1W (24V)	1W (30V)
Voltage Marking	Die stamped on the base			
Life (reference value)	Approx. 1,000 hours minimum (mean value when used on the rated voltage)			

LED Lamp Ratings (LSTD Type)

Type No.	LSTD-6②	LSTD-1②	LSTD-2②
Lamp Base	BA9S/13		
Rated Voltage	6V AC/DC	12V AC/DC	24V AC/DC
Voltage Range	6V AC/DC ±10%	12V AC/DC ±10%	24V AC/DC ±10%
Current Draw	AC	A, R, W, Y: 17 mA, G, PW, S: 8 mA	11 mA
	DC	A, R, W, Y: 14 mA, G, PW, S: 5.5 mA	10 mA
Color Code ②	A (amber), G (green), PW (pure white), R (red), S (blue), W (white), Y (yellow)		
Lamp Base Color	Same as illumination color		
Voltage Marking	Die stamped on the base		
Life (reference value)	Approx. 50,000 hours (The luminance reduces to 50% the initial intensity when used on complete DC.)		
Internal Circuit	A, R, W, Y		
	G, PW, S		

Specifications

Operating Temperature	-25 to +50°C (no freezing)
Storage Temperature	-40 to +80°C
Operating Humidity	45 to 85% RH (no condensation)
Contact Resistance	50 mΩ maximum (initial value)
Insulation Resistance	100 MΩ minimum (500V DC megger)
Dielectric Strength	Between live and dead metal parts: 2,500V AC, 1 minute (Full voltage type illuminated units: 2,000V AC, 1 minute)
Vibration Resistance	Operating extremes: 5 to 55 Hz, amplitude 0.5 mm
Shock Resistance	Damage limits: 1,000 m/s ² Operating extremes: 100 m/s ²
Mechanical Life (minimum operations)	Pushbuttons, Illuminated pushbuttons Momentary: 5,000,000 Others: 500,000 Selector switches: 500,000 Illuminated selector switches: 500,000
Electrical Life (minimum operations)	Pushbuttons: 500,000 (switching frequency 1,800 operations/h, duty ratio 40%) Illuminated pushbuttons: 500,000 (switching frequency 1,800 operations/h, duty ratio 40%) Selector switches: 500,000 (switching frequency 1,200 operations/h, duty ratio 40%)

Mounting Hole Layout

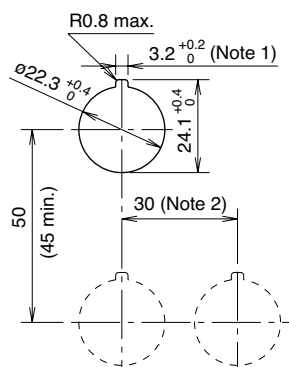

Note 1: The 3.2 mm recess is for preventing rotation and is not necessary when the nameplate or anti-rotation ring is not used.

Note 2: The minimum mounting centers are applicable to switches with one layer of contact blocks (two contact blocks). When two layers of contact blocks are mounted, determine the minimum mounting centers in consideration of convenience for wiring.

- ø40mm mushroom: 40 mm minimum
- 2-position, 3-position lever type selector switch: 39 mm minimum
- 4-position, 5-position lever type selector switch: 50 mm minimum

Degree of Protection

Type No.	Unit	NEMA ICS 6-110	IEC 60529
A****	Pushbuttons, pilot lights, illuminated pushbuttons, and selector switches	Type 1, 2, 3, 3R, (3S), 4, 5, 12, 13	IP65
	Illuminated selector switches, key pushbuttons, key reset pushbuttons, and key selector switches	Type 1, 2, 3R, 5, 12, 13	IP54

Note: (3S) of NEMA ICS 6-110 applies to the pilot lights with round lens.

ø22 TW Series Control Units (Ordering Information)

Ordering Information

- Specify an operator or lens color code in the Type No.
- Full voltage type illuminated units are not supplied with a lamp. Order LED or incandescent lamps separately. Transformer and DC-DC converter type illuminated units contain an LED or incandescent lamp.
- When a terminal cover is required, order an applicable terminal cover referring to page 30.

Rated Voltage	LED Lamp	Incandescent
100/110V AC	LSTD-6②	LS-6
200/220V AC	LSTD-6②	LS-6
110V DC	LSTD-6②	LS-6

- All standard units are UL, CSA, EN, and TÜV approved.

The Type No. development charts shown below can be used to specify control units other than those listed on the following pages. Gold-plated silver contacts are also available.

Pushbuttons

ABW1 11 R - MAU

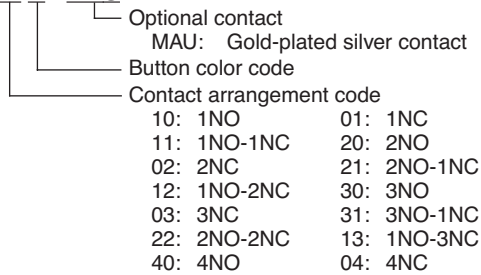

Note:

- Push-pull type AYW4 can have a maximum of two contact blocks.

Pilot Lights

APW2 116 D R

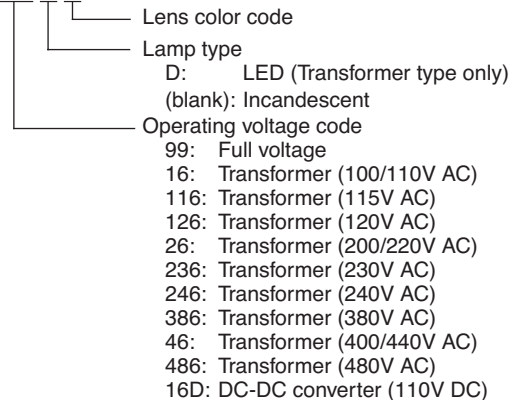

Note:

- Full voltage type is not supplied with a lamp.
- Transformer and DC-DC converter types contain an LED lamp (LSTD-6②) or incandescent lamp (LS-6).

Illuminated Pushbuttons

ALFW2 116 13 D R - MAU

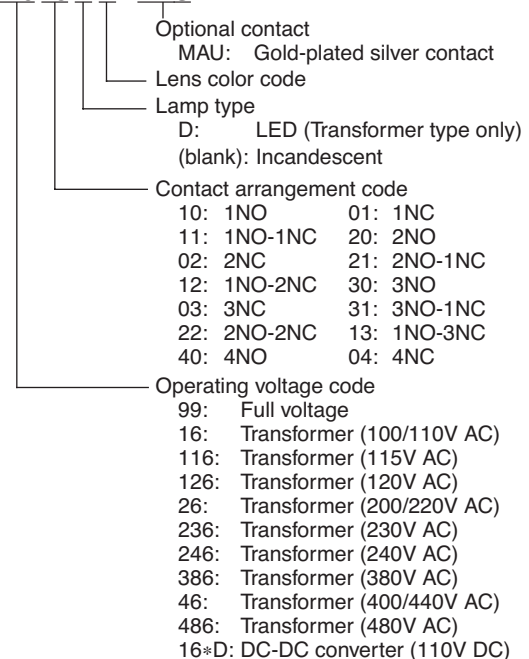

Note:

- Push-pull type AYLW4 can have a maximum of two contact blocks.
- Transformer type and DC-DC converter type cannot have an odd number of contact blocks, such as 1NO, 1NC, 3NO, 2NO-1NC, 1NO-2NC, and 3NC.

Selector Switch

ASW 2 L 11 - MAU

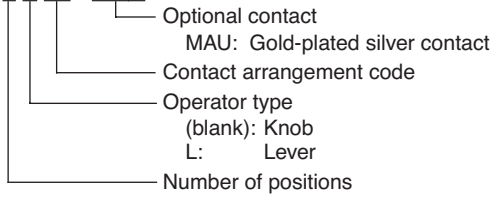

Note:

- See pages 26 to 28 for contact arrangement codes.

Key Selector Switch

ASW 2 K 20 B - MAU

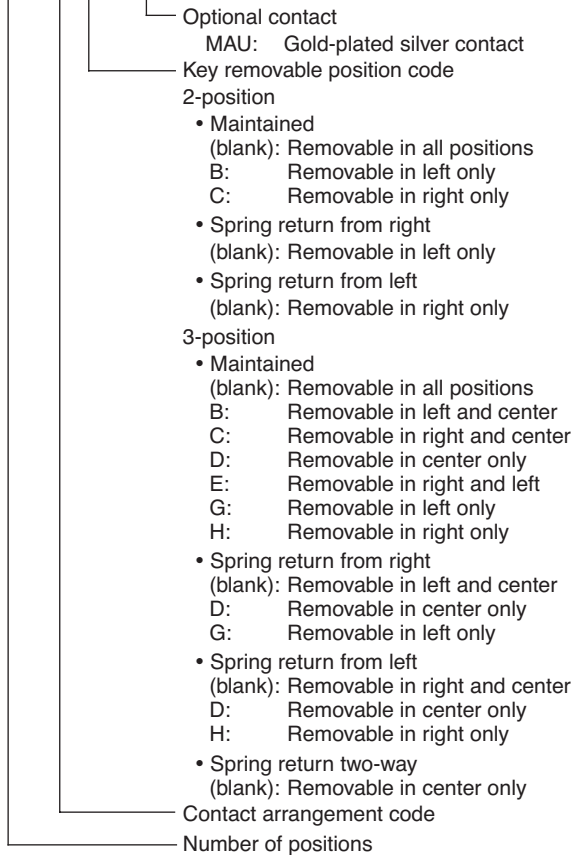

Note:

- See pages 27 to 29 for contact arrangement codes.
- The key cannot be removed in the return position.

Illuminated Selector Switch

ASLW 2 16 22 D R - MAU

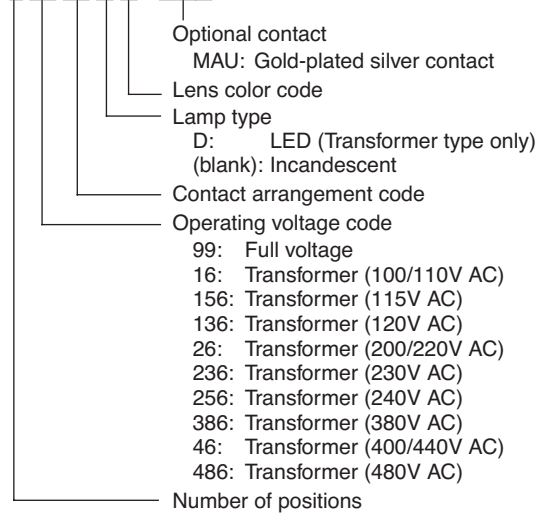







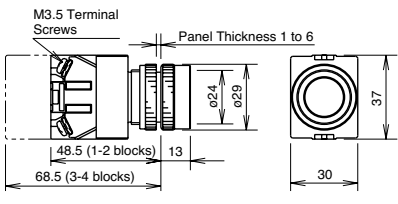

Note:

- Full voltage type is not supplied with a lamp.
- Transformer type contains an LED lamp (LSTD-6[®]) or incandescent lamp (LS-6).
- See pages 27 to 29 for contact arrangement codes.

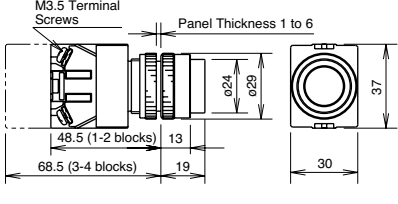

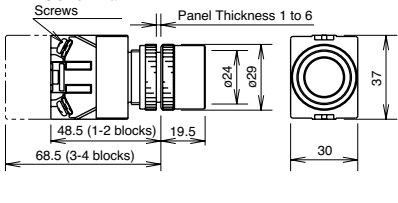

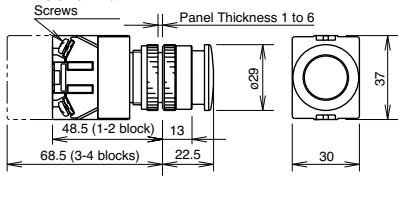





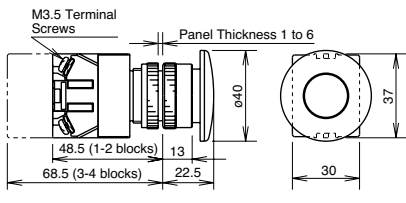

ø22 TW Series Pushbuttons

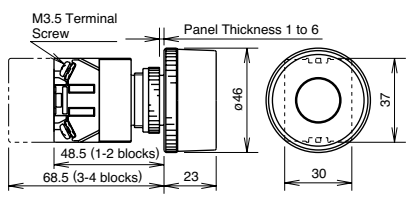
Flush / Extended / Extended w/Full Shroud / Mushroom Types

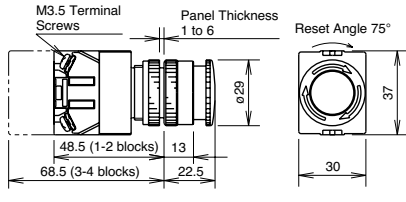
Shape	Operation Type	Contact	Type No.	① Button Color Code	Dimensions (mm)			
Flush ABW1 AOW1  	Momentary	1NO	ABW110①	Specify a button color code in place of ① in the Type No. B: black G: green R: red S: blue W: white Y: yellow				
		1NC	ABW101①					
		1NO-1NC	ABW111①					
		2NO	ABW120①					
		2NC	ABW102①					
		2NO-2NC	ABW122①					
	Maintained	1NO	AOW110①					
		1NC	AOW101①					
		1NO-1NC	AOW111①					
		2NO	AOW120①					
		2NC	AOW102①					
		2NO-2NC	AOW122①					
		Extended ABW2 AOW2  	Momentary			1NO	ABW210①	
						1NC	ABW201①	
1NO-1NC	ABW211①							
2NO	ABW220①							
2NC	ABW202①							
2NO-2NC	ABW222①							
Maintained	1NO		AOW210①					
	1NC		AOW201①					
	1NO-1NC		AOW211①					
	2NO		AOW220①					
	2NC		AOW202①					
	2NO-2NC		AOW222①					
Extended with Full Shroud ABFW2 AOFW2  	Momentary	1NO	ABFW210①					
		1NC	ABFW201①					
		1NO-1NC	ABFW211①					
		2NO	ABFW220①					
		2NC	ABFW202①					
		2NO-2NC	ABFW222①					
	Maintained	1NO	AOFW210①					
		1NC	AOFW201①					
		1NO-1NC	AOFW211①					
		2NO	AOFW220①					
		2NC	AOFW202①					
		2NO-2NC	AOFW222①					
ø29mm Mushroom ABW3 AOW3  	Momentary	1NO	ABW310①					
		1NC	ABW301①					
		1NO-1NC	ABW311①					
		2NO	ABW320①					
		2NC	ABW302①					
		2NO-2NC	ABW322①					
	Maintained	1NO	AOW310①					
		1NC	AOW301①					
		1NO-1NC	AOW311①					
		2NO	AOW320①					
		2NC	AOW302①					
		2NO-2NC	AOW322①					

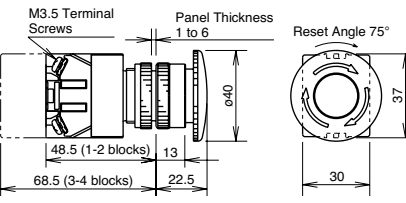
- Specify a button color code in place of ① in the Type No.
- Round bezel and shroud (metal): Mat aluminum color
- Pushbuttons with one or three contact blocks contain a dummy block.
- Other contact arrangements and gold-plated silver contacts are also available. See page 6.

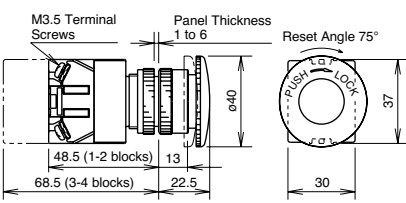
Mushroom / Pushlock Turn Reset / Push Turn Lock / Pushlock Key Reset Types

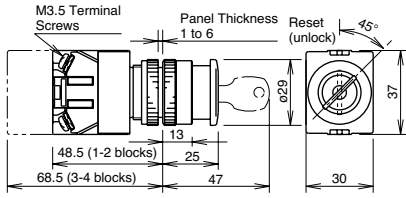



Shape	Operation Type	Contact	Type No.	① Button Color Code	Dimensions (mm)
ø40mm Mushroom ABW4 AOW4  	Momentary	1NO	ABW410①	Specify a button color code in place of ① in the Type No. B: black G: green R: red S: blue W: white Y: yellow	
		1NC	ABW401①		
		1NO-1NC	ABW411①		
		2NO	ABW420①		
		2NC	ABW402①		
	Maintained	1NO	AOW410①		
		1NC	AOW401①		
		1NO-1NC	AOW411①		
		2NO	AOW420①		
		2NC	AOW402①		
2NO-2NC	AOW422①				
ø40mm Mushroom w/Full Shroud ABGW4  	Momentary	1NO	ABGW410①	Specify a button color code in place of ① in the Type No. B: black G: green R: red S: blue W: white Y: yellow	
		1NC	ABGW401①		
		1NO-1NC	ABGW411①		
		2NO	ABGW420①		
		2NC	ABGW402①		
		2NO-2NC	ABGW422①		
ø29mm Pushlock Turn Reset AVW3 (Note)  		1NO	AVW310①	R: red Y: yellow	
		1NC	AVW301①		
		1NO-1NC	AVW311①		
		2NO	AVW320①		
		2NC	AVW302①		
		2NO-2NC	AVW322①		
ø40mm Pushlock Turn Reset AVW4 (Note)  		1NO	AVW410①	R: red Y: yellow	
		1NC	AVW401①		
		1NO-1NC	AVW411①		
		2NO	AVW420①		
		2NC	AVW402①		
		2NO-2NC	AVW422①		
ø40mm Push Turn Lock AJW4  		1NO	AJW410①	B: black G: green R: red Y: yellow	
		1NC	AJW401①		
		1NO-1NC	AJW411①		
		2NO	AJW420①		
		2NC	AJW402①		
		2NO-2NC	AJW422①		
ø29mm Pushlock Key Reset AXW3 (Note)  		1NO	AXW310R	Red only	
		1NC	AXW301R		
		1NO-1NC	AXW311R		
		2NO	AXW320R		
		2NC	AXW302R		
		2NO-2NC	AXW322R		

- Specify a button color code in place of ① in the Type No.
- Round bezel (metal): Mat aluminum color
- Pushbuttons with one or three contact blocks contain a dummy block.
- Other contact arrangements and gold-plated silver contacts are also available. See page 6.

Note: AVW3, AVW4, and AXW3 pushbuttons cannot be used as emergency stop switches. When emergency stop switches are required, use XW or HW series pushbuttons (ISO 13850 and IEC 60947-5-5 compliant).

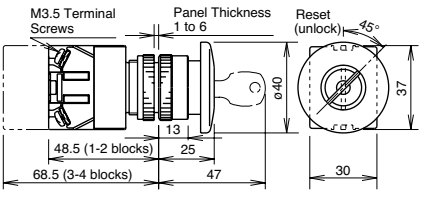
ø22 TW Series Pushbuttons

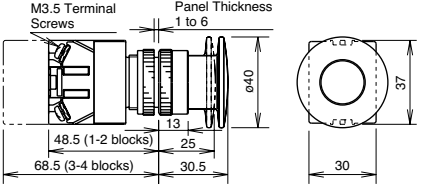
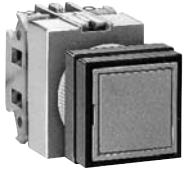
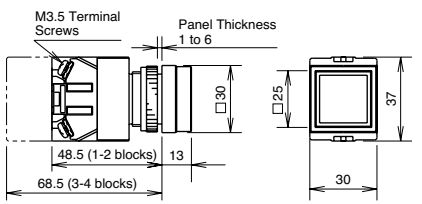
Pushlock Key Reset / Push-Pull / Square Flush / Square Extended

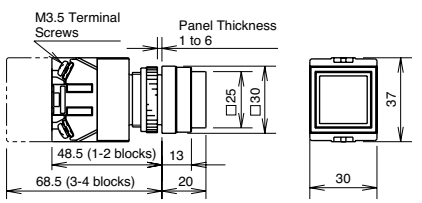
Shape	Operation Type	Contact	Type No.	① Button Color Code	Dimensions (mm)	
ø40mm Mushroom Push Lock Key Reset AXW4 		1NO	AXW410R	Red only		
		1NC	AXW401R			
		1NO-1NC	AXW411R			
		2NO	AXW420R			
		2NC	AXW402R			
		2NO-2NC	AXW422R			
ø40mm Mushroom Push-Pull AYW4 		1NO	AYW410①			
		1NC	AYW401①			
		1NO-1NC	AYW411①			
		2NO	AYW420①			
		2NC	AYW402①			
Square Flush ABQW1 AOQW1 	Momentary	1NO	ABQW110①	B: black G: green R: red S: blue W: white Y: yellow		
			1NC			ABQW101①
			1NO-1NC			ABQW111①
			2NO			ABQW120①
			2NC			ABQW102①
	Maintained	2NO-2NC	ABQW122①			
		1NO	AOQW110①			
		1NC	AOQW101①			
		1NO-1NC	AOQW111①			
		2NO	AOQW120①			
	2NC	AOQW102①				
	2NO-2NC	AOQW122①				
Square Extended ABQW2 AOQW2 	Momentary	1NO	ABQW210①			
			1NC			ABQW201①
			1NO-1NC			ABQW211①
			2NO			ABQW220①
			2NC			ABQW202①
	Maintained	2NO-2NC	ABQW222①			
		1NO	AOQW210①			
		1NC	AOQW201①			
		1NO-1NC	AOQW211①			
		2NO	AOQW220①			
	2NC	AOQW202①				
	2NO-2NC	AOQW222①				









- Specify a button color code in place of ① in the Type No.
- Round bezel (metal): Mat aluminum color
- Square bezel (plastic): Black
- Pushbuttons with one or three contact blocks contain a dummy block.
- Other contact arrangements and gold-plated silver contacts are also available. See page 6.

• Contact Statuses of Push-Pull Switch

Contact	ø40mm Mushroom Push-Pull Switch	
	Push	Pull
1NO	○+○	○-○
1NC	●+●	●-●
1NO-1NC	○+○ ●+●	○-○ ●-●
2NO	○+○ ○+○	○-○ ○-○
2NC	●+● ●+●	●-● ●-●

- Note: Push-pull switch can have a maximum of two contact blocks.

Round Flush / Dome / Square Flush Types

Shape	Lamp	Input Type	Type No.	② Lens/LED Color Code	③ Operating Voltage Code
Round Flush APW1  	Without Lamp	Full Voltage	APW199②	A: amber G: green PW: pure white R: red S: blue W: white Y: yellow	Specify an operating voltage code in place of ③ in the Type No. 16: 100/110V AC 116: 115 AC 126: 120V AC 26: 200/220V AC 236: 230V AC 246: 240V AC 386: 380V AC 46: 400/440V AC 486: 480V AC
	LED	Transformer	APW1③D②	A: amber G: green PW: pure white R: red S: blue W: white Y: yellow	
		DC-DC Converter*	APW11DD②		
Incandescent	Transformer	APW1③②	A: amber G: green R: red S: blue W: white		
Round Flush (Marking) APW1B  	Without Lamp	Full Voltage	APW1B99②	A: amber G: green PW: pure white R: red S: blue W: white Y: yellow	
	LED	Transformer	APW1B③D②	A: amber G: green PW: pure white R: red S: blue W: white Y: yellow	
		DC-DC Converter*	APW1B16DD②		
Incandescent	Transformer	APW1B③②	A: amber G: green R: red S: blue W: white		
Dome APW2  	Without Lamp	Full Voltage	APW299②	A: amber G: green PW: pure white R: red S: blue W: white Y: yellow	
	LED	Transformer	APW2③D②	A: amber G: green PW: pure white R: red S: blue W: white Y: yellow	
		DC-DC Converter*	APW216DD②		
Incandescent	Transformer	APW2③②	A: amber G: green R: red S: blue W: white		
Square Flush (Marking) APQW1B  	Without Lamp	Full Voltage	APQW1B99②	A: amber G: green PW: pure white R: red S: blue W: white Y: yellow	
	LED	Transformer	APQW1B③D②	A: amber G: green PW: pure white R: red S: blue W: white Y: yellow	
		DC-DC Converter*	APQW1B16DD②		
Incandescent	Transformer	APQW1B③②	A: amber G: green R: red S: blue W: white		

- Specify a lens/LED color code in place of ② in the Type No.
- The white (W) lens of APW1B and APQW1B types is a combination of clear lens and white marking plate.
- Specify an operating voltage code in place of ③ in the Type No.
- Full voltage types do not contain a lamp. Order LED or incandescent lamps separately. For lamps, see page 36.
- LED illuminated transformer and DC-DC converter types contain an LED lamp (LSTD-6②, rated voltage 6V AC/DC).
- Incandescent illuminated transformer types contain an incandescent lamp (LS-6, rated voltage 6V AC/DC).
- Round bezel (metal): Mat aluminum color
- Square bezel (plastic): Black
- * DC-DC converter types are not approved by UL, CSA, and TÜV, and not CE compliant (operating voltage 90 to 140V DC).

ø22 TW Series Pilot Lights

Dimensions

- Round Flush APW1
Full Voltage

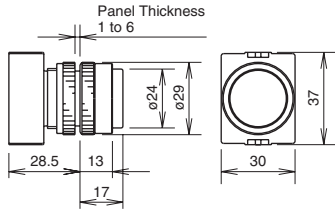

- Round Flush APW1
Transformer, DC-DC Converter

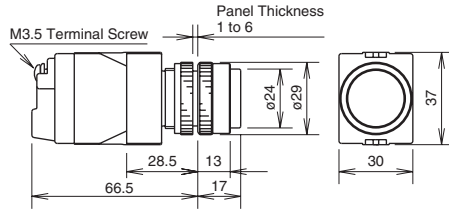

- Round Flush Marking Type APW1B
Full Voltage

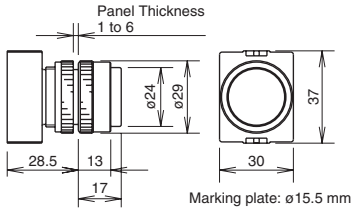

- Round Flush Marking Type APW1B
Transformer, DC-DC Converter

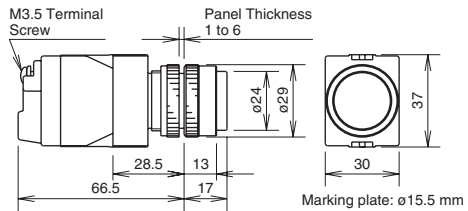

- Dome APW2
Full Voltage

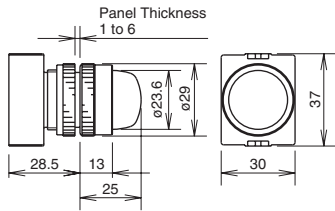

- Dome APW2
Transformer, DC-DC Converter

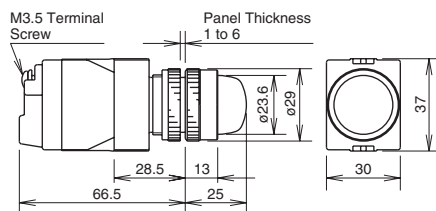

- Square Flush Marking Type APQW1B
Full Voltage

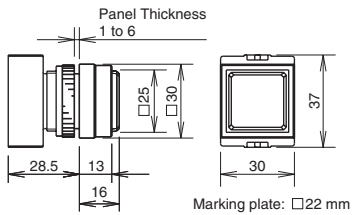

- Square Flush Marking Type APQW1B
Transformer, DC-DC Converter

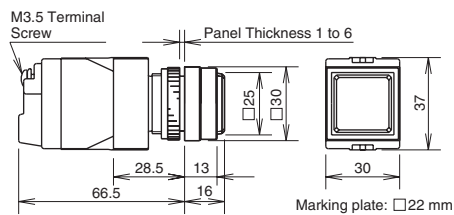



Terminal Wiring (Bottom View)

All dimensions in mm.

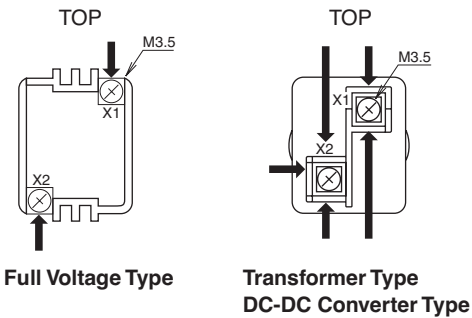
• Arrows indicate access directions for wiring.

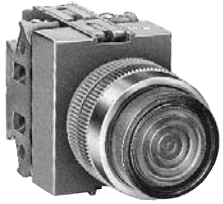

Round Extended Illuminated Pushbuttons

Shape	Operation Type	Lamp	Input Type	Contact	Type No.		
Round Extended ALW2 AOLW2  	Momentary	Without Lamp	Full Voltage	1NO-1NC	ALW29911②		
				2NO	ALW29920②		
				2NO-2NC	ALW29922②		
				LED	Transformer	1NO-1NC	ALW2③11D②
						2NO	ALW2③20D②
						2NO-2NC	ALW2③22D②
		DC-DC Converter*	Transformer	1NO-1NC	ALW21611DD②		
				2NO	ALW21620DD②		
				2NO-2NC	ALW21622DD②		
		Incandescent	Transformer	1NO-1NC	ALW2③11②		
				2NO	ALW2③20②		
				2NO-2NC	ALW2③22②		
	Maintained			Without Lamp	Full Voltage	1NO-1NC	AOLW29911②
						2NO	AOLW29920②
						2NO-2NC	AOLW29922②
		LED	Transformer			1NO-1NC	AOLW2③11D②
						2NO	AOLW2③20D②
						2NO-2NC	AOLW2③22D②
		DC-DC Converter*	Transformer	1NO-1NC	AOLW21611DD②		
				2NO	AOLW21620DD②		
				2NO-2NC	AOLW21622DD②		
		Incandescent	Transformer	1NO-1NC	AOLW2③11②		
				2NO	AOLW2③20②		
				2NO-2NC	AOLW2③22②		





• Color Code and Operating Voltage Code

LED Illuminated Type	Incandescent Illuminated Type	③ Operating Voltage Code
② Lens/LED Color Code	② Lens Color Code	
Specify a lens/LED color code in place of ② in the Type No. A: amber G: green PW: pure white R: red S: blue W: white Y: yellow	Specify a lens color code in place of ② in the Type No. A: amber G: green R: red S: blue W: white	Specify an operating voltage code in place of ③ in the Type No. 16: Transformer (100/110V AC) 116: Transformer (115V AC) 126: Transformer (120V AC) 26: Transformer (200/220V AC) 236: Transformer (230V AC) 246: Transformer (240V AC) 386: Transformer (380V AC) 46: Transformer (400/440V AC) 486: Transformer (480V AC)

- Full voltage types do not contain a lamp. Order LED or incandescent lamps separately. For lamps, see page 36.
- LED illuminated transformer and DC-DC converter types contain an LED lamp (LSTD-6②, rated voltage 6V AC/DC).
- Incandescent illuminated transformer types contain an incandescent lamp (LS-6, rated voltage 6V AC/DC).
- * DC-DC converter types are not approved by UL, CSA, and TÜV, and not CE compliant (operating voltage 90 to 140V DC).

ø22 TW Series Illuminated Pushbuttons

Round Extended Illuminated Pushbuttons (Marking Type)





Shape	Operation Type	Lamp	Input Type	Contact	Type No.		
Round Extended (Marking) ALW2B AOLW2B    	Momentary	Without Lamp	Full Voltage	1NO-1NC	ALW2B9911②		
				2NO	ALW2B9920②		
				2NO-2NC	ALW2B9922②		
				LED	Transformer	1NO-1NC	ALW2B③11D②
						2NO	ALW2B③20D②
						2NO-2NC	ALW2B③22D②
		DC-DC Converter*	1NO-1NC		ALW2B1611DD②		
			2NO		ALW2B1620DD②		
			2NO-2NC		ALW2B1622DD②		
		Incandescent	Transformer	1NO-1NC	ALW2B③11②		
				2NO	ALW2B③20②		
				2NO-2NC	ALW2B③22②		
	Maintained			Without Lamp	Full Voltage	1NO-1NC	AOLW2B9911②
						2NO	AOLW2B9920②
						2NO-2NC	AOLW2B9922②
		LED	Transformer			1NO-1NC	AOLW2B③11D②
						2NO	AOLW2B③20D②
						2NO-2NC	AOLW2B③22D②
			DC-DC Converter*	1NO-1NC	AOLW2B1611DD②		
				2NO	AOLW2B1620DD②		
				2NO-2NC	AOLW2B1622DD②		
		Incandescent	Transformer	1NO-1NC	AOLW2B③11②		
				2NO	AOLW2B③20②		
				2NO-2NC	AOLW2B③22②		

• Color Code and Operating Voltage Code

LED Illuminated Type	Incandescent Illuminated Type	③ Operating Voltage Code
② Lens/LED Color Code	② Lens Color Code	
Specify a lens/LED color code in place of ② in the Type No. A: amber G: green PW: pure white R: red S: blue W: white Y: yellow	Specify a lens color code in place of ② in the Type No. A: amber G: green R: red S: blue W: white	Specify an operating voltage code in place of ③ in the Type No. 16: Transformer (100/110V AC) 116: Transformer (115V AC) 126: Transformer (120V AC) 26: Transformer (200/220V AC) 236: Transformer (230V AC) 246: Transformer (240V AC) 386: Transformer (380V AC) 46: Transformer (400/440V AC) 486: Transformer (480V AC)

- Full voltage types do not contain a lamp. Order LED or incandescent lamps separately. For lamps, see page 36.
- LED illuminated transformer and DC-DC converter types contain an LED lamp (LSTD-6②, rated voltage 6V AC/DC).
- Incandescent illuminated transformer types contain an incandescent lamp (LS-6, rated voltage 6V AC/DC).
- * DC-DC converter types are not approved by UL, CSA, and TÜV, and not CE compliant (operating voltage 90 to 140V DC).

Round Extended with Full Shroud Illuminated Pushbuttons

Shape	Operation Type	Lamp	Input Type	Contact	Type No.		
Round Extended With Full Shroud ALFW2 AOLFW2     	Momentary	Without Lamp	Full Voltage	1NO-1NC	ALFW29911②		
				2NO	ALFW29920②		
				2NO-2NC	ALFW29922②		
				1NO-1NC	ALFW2③11D②		
				2NO	ALFW2③20D②		
				2NO-2NC	ALFW2③22D②		
		LED	Transformer	1NO-1NC	ALFW21611DD②		
				2NO	ALFW21620DD②		
				2NO-2NC	ALFW21622DD②		
			DC-DC Converter*	1NO-1NC	ALFW21611DD②		
				2NO	ALFW21620DD②		
				2NO-2NC	ALFW21622DD②		
	Incandescent	Transformer	1NO-1NC	ALFW2③11②			
			2NO	ALFW2③20②			
			2NO-2NC	ALFW2③22②			
			Maintained	Without Lamp	Full Voltage	1NO-1NC	AOLFW29911②
						2NO	AOLFW29920②
						2NO-2NC	AOLFW29922②
	1NO-1NC	AOLFW2③11D②					
	2NO	AOLFW2③20D②					
	2NO-2NC	AOLFW2③22D②					
	LED	Transformer		1NO-1NC	AOLFW21611DD②		
				2NO	AOLFW21620DD②		
				2NO-2NC	AOLFW21622DD②		
DC-DC Converter*		1NO-1NC		AOLFW21611DD②			
		2NO		AOLFW21620DD②			
		2NO-2NC		AOLFW21622DD②			
Incandescent	Transformer	1NO-1NC	AOLFW2③11②				
		2NO	AOLFW2③20②				
		2NO-2NC	AOLFW2③22②				





• Color Code and Operating Voltage Code

LED Illuminated Type	Incandescent Illuminated Type	③ Operating Voltage Code
② Lens/LED Color Code	② Lens Color Code	
Specify a lens/LED color code in place of ② in the Type No. A: amber G: green PW: pure white R: red S: blue W: white Y: yellow	Specify a lens color code in place of ② in the Type No. A: amber G: green R: red S: blue W: white	Specify an operating voltage code in place of ③ in the Type No. 16: Transformer (100/110V AC) 116: Transformer (115V AC) 126: Transformer (120V AC) 26: Transformer (200/220V AC) 236: Transformer (230V AC) 246: Transformer (240V AC) 386: Transformer (380V AC) 46: Transformer (400/440V AC) 486: Transformer (480V AC)

- Full voltage types do not contain a lamp. Order LED or incandescent lamps separately. For lamps, see page 36.
- LED illuminated transformer and DC-DC converter types contain an LED lamp (LSTD-6②, rated voltage 6V AC/DC).
- Incandescent illuminated transformer types contain an incandescent lamp (LS-6, rated voltage 6V AC/DC).
- * DC-DC converter types are not approved by UL, CSA, and TÜV, and not CE compliant (operating voltage 90 to 140V DC).

ø22 TW Series Illuminated Pushbuttons

Round Extended with Full Shroud Illuminated Pushbuttons (Marking Type)





Shape	Operation Type	Lamp	Input Type	Contact	Type No.		
Round Extended (Marking) With Full Shroud ALFW2B AOLFW2B     	Momentary	Without Lamp	Full Voltage	1NO-1NC	ALFW2B9911②		
				2NO	ALFW2B9920②		
				2NO-2NC	ALFW2B9922②		
				LED	Transformer	1NO-1NC	ALFW2B③11D②
						2NO	ALFW2B③20D②
						2NO-2NC	ALFW2B③22D②
		DC-DC Converter*	1NO-1NC	ALFW2B1611DD②			
			2NO	ALFW2B1620DD②			
			2NO-2NC	ALFW2B1622DD②			
		Incandescent	Transformer	1NO-1NC	ALFW2B③11②		
				2NO	ALFW2B③20②		
				2NO-2NC	ALFW2B③22②		
	Maintained			Without Lamp	Full Voltage	1NO-1NC	AOLFW2B9911②
						2NO	AOLFW2B9920②
						2NO-2NC	AOLFW2B9922②
		LED	Transformer			1NO-1NC	AOLFW2B③11D②
						2NO	AOLFW2B③20D②
						2NO-2NC	AOLFW2B③22D②
		DC-DC Converter*	1NO-1NC	AOLFW2B1611DD②			
			2NO	AOLFW2B1620DD②			
			2NO-2NC	AOLFW2B1622DD②			
		Incandescent	Transformer	1NO-1NC	AOLFW2B③11②		
				2NO	AOLFW2B③20②		
				2NO-2NC	AOLFW2B③22②		

• Color Code and Operating Voltage Code

LED Illuminated Type	Incandescent Illuminated Type	③ Operating Voltage Code
② Lens/LED Color Code	② Lens Color Code	
Specify a lens/LED color code in place of ② in the Type No. A: amber G: green PW: pure white R: red S: blue W: white Y: yellow	Specify a lens color code in place of ② in the Type No. A: amber G: green R: red S: blue W: white	Specify an operating voltage code in place of ③ in the Type No. 16: Transformer (100/110V AC) 116: Transformer (115V AC) 126: Transformer (120V AC) 26: Transformer (200/220V AC) 236: Transformer (230V AC) 246: Transformer (240V AC) 386: Transformer (380V AC) 46: Transformer (400/440V AC) 486: Transformer (480V AC)

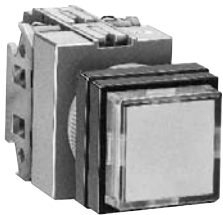
- Full voltage types do not contain a lamp. Order LED or incandescent lamps separately. For lamps, see page 36.
- LED illuminated transformer and DC-DC converter types contain an LED lamp (LSTD-6②, rated voltage 6V AC/DC).
- Incandescent illuminated transformer types contain an incandescent lamp (LS-6, rated voltage 6V AC/DC).
- * DC-DC converter types are not approved by UL, CSA, and TÜV, and not CE compliant (operating voltage 90 to 140V DC).

Square Extended Illuminated Pushbuttons (Marking Type)

Shape	Operation Type	Lamp	Input Type	Contact	Type No.
Square Extended (Marking) ALQW2B AOLQW2B    	Momentary	Without Lamp	Full Voltage	1NO-1NC	ALQW2B9911②
				2NO	ALQW2B9920②
				2NO-2NC	ALQW2B9922②
				1NO-1NC	ALQW2B③11D②
				2NO	ALQW2B③20D②
				2NO-2NC	ALQW2B③22D②
		LED	Transformer	1NO-1NC	ALQW2B1611DD②
				2NO	ALQW2B1620DD②
				2NO-2NC	ALQW2B1622DD②
				1NO-1NC	ALQW2B③11②
				2NO	ALQW2B③20②
				2NO-2NC	ALQW2B③22②
	Incandescent	Transformer	1NO-1NC	ALQW2B③11②	
			2NO	ALQW2B③20②	
			2NO-2NC	ALQW2B③22②	
			1NO-1NC	AOLQW2B9911②	
			2NO	AOLQW2B9920②	
			2NO-2NC	AOLQW2B9922②	
	Maintained	Without Lamp	Full Voltage	1NO-1NC	AOLQW2B③11D②
				2NO	AOLQW2B③20D②
				2NO-2NC	AOLQW2B③22D②
				1NO-1NC	AOLQW2B1611DD②
				2NO	AOLQW2B1620DD②
				2NO-2NC	AOLQW2B1622DD②
LED		Transformer	1NO-1NC	AOLQW2B③11②	
			2NO	AOLQW2B③20②	
			2NO-2NC	AOLQW2B③22②	
			1NO-1NC	AOLQW2B③11②	
			2NO	AOLQW2B③20②	
			2NO-2NC	AOLQW2B③22②	
Incandescent	Transformer	1NO-1NC	AOLQW2B③11②		
		2NO	AOLQW2B③20②		
		2NO-2NC	AOLQW2B③22②		

• Color Code and Operating Voltage Code

LED Illuminated Type	Incandescent Illuminated Type	③ Operating Voltage Code
② Lens/LED Color Code	② Lens Color Code	
Specify a lens/LED color code in place of ② in the Type No. A: amber G: green PW: pure white R: red S: blue W: white Y: yellow	Specify a lens color code in place of ② in the Type No. A: amber G: green R: red S: blue W: white	Specify an operating voltage code in place of ③ in the Type No. 16: Transformer (100/110V AC) 116: Transformer (115V AC) 126: Transformer (120V AC) 26: Transformer (200/220V AC) 236: Transformer (230V AC) 246: Transformer (240V AC) 386: Transformer (380V AC) 46: Transformer (400/440V AC) 486: Transformer (480V AC)

- Full voltage types do not contain a lamp. Order LED or incandescent lamps separately. For lamps, see page 36.
- LED illuminated transformer and DC-DC converter types contain an LED lamp (LSTD-6②, rated voltage 6V AC/DC).
- Incandescent illuminated transformer types contain an incandescent lamp (LS-6, rated voltage 6V AC/DC).
- * DC-DC converter types are not approved by UL, CSA, and TÜV, and not CE compliant (operating voltage 90 to 140V DC).

ø22 TW Series Illuminated Pushbuttons

Mushroom (ø29) Illuminated Pushbuttons

Shape	Operation Type	Lamp	Input Type	Contact	Type No.
ø29 Mushroom ALW3 AOLW3  	Momentary	Without Lamp	Full Voltage	1NO-1NC	ALW39911②
		Incandescent	Transformer		ALW3③11②
	Maintained	Without Lamp	Full Voltage		AOLW39911②
		Incandescent	Transformer		AOLW3③11②
ø29 Mushroom (Marking Type) ALW3B AOLW3B  	Momentary	Without Lamp	Full Voltage		ALW3B9911②
		Incandescent	Transformer		ALW3B③11②
	Maintained	Without Lamp	Full Voltage		AOLW3B9911②
		Incandescent	Transformer		AOLW3B③11②
ø29 Mushroom Pushlock Turn Reset AVLW3  		Without Lamp	Full Voltage	1NO-1NC	AVLW39911R
				2NO	AVLW39920R
		LED	Transformer	1NO-1NC	AVLW3③11DR
				2NO	AVLW3③20DR
		Incandescent	Transformer	1NO-1NC	AVLW3③11R
				2NO	AVLW3③20R
		2NO-2NC	AVLW3③22R		
			ø29 Mushroom Pushlock Turn Reset (Marking Type) AVLW3B  	Without Lamp	Full Voltage
1NC	AVLW3B9920R				
1NO-1NC	AVLW3B9922R				
	1NO-1NC	AVLW3B③11DR			
LED	Transformer	2NO		AVLW3B③20DR	
		2NO-2NC		AVLW3B③22DR	
1NO-1NC	AVLW3B③11R				
	2NO	AVLW3B③20R			
2NO-2NC	AVLW3B③22R				

• Color Code and Operating Voltage Code

Incandescent Illuminated Type	③ Operating Voltage Code
② Lens Color Code	
Specify a lens color code in place of ② in the Type No.	Specify an operating voltage code in place of ③ in the Type No.
A: amber G: green R: red S: blue W: white	16: Transformer (100/110V AC) 116: Transformer (115V AC) 126: Transformer (120V AC) 26: Transformer (200/220V AC) 236: Transformer (230V AC) 246: Transformer (240V AC) 386: Transformer (380V AC) 46: Transformer (400/440V AC) 486: Transformer (480V AC)

- Full voltage types do not contain a lamp. Order LED or incandescent lamps separately. For lamps, see page 36.
- LED illuminated transformer types contain an LED lamp (LSTD-6②, rated voltage 6V AC/DC).
- Incandescent illuminated transformer types contain an incandescent lamp (LS-6, rated voltage 6V AC/DC).

Mushroom (ø40 mm) Illuminated Pushbuttons

Shape	Lamp	Input Type	Contact	Type No.
ø40 Mushroom Pushlock Turn Reset AVLW4  	Without Lamp	Full Voltage	1NO-1NC	AVLW49911R
			2NO	AVLW49920R
			2NO-2NC	AVLW49922R
	LED	Transformer	1NO-1NC	AVLW4③11DR
			2NO	AVLW4③20DR
			2NO-2NC	AVLW4③22DR
	Incandescent	Transformer	1NO-1NC	AVLW4③11R
			2NO	AVLW4③20R
			2NO-2NC	AVLW4③22R
ø40 Mushroom Pushlock Turn Reset (Marking Type) AVLW4B  	Without Lamp	Full Voltage	1NO	AVLW4B9911R
			1NC	AVLW4B9920R
			1NO-1NC	AVLW4B9922R
	LED	Transformer	1NO-1NC	AVLW4B③11DR
			2NO	AVLW4B③20DR
			2NO-2NC	AVLW4B③22DR
	Incandescent	Transformer	1NO-1NC	AVLW4B③11R
			2NO	AVLW4B③20R
			2NO-2NC	AVLW4B③22R
ø40 Mushroom Push Pull AYLW4 (2-position maintained)  	Without Lamp	Full Voltage	1NO-1NC	AYLW49911②
			2NO	AYLW49920②
	Incandescent	Transformer	1NO-1NC	AYLW4③11②
			2NO	AYLW4③20②
ø40 Mushroom Push Pull (Marking Type) AYLW4B (2-position maintained)  	Without Lamp	Full Voltage	1NO	AYLW4B9911②
			1NC	AYLW4B9920②
			1NO-1NC	AYLW4B9922②
	Incandescent	Transformer	1NO-1NC	AYLW4B③11②
		2NO	AYLW4B③20②	

• Color Code and Operating Voltage Code

Incandescent Illuminated Type	③ Operating Voltage Code
② Lens Color Code	
Specify a lens color code in place of ② in the Type No. A: amber G: green R: red S: blue W: white (AYLW4 only)	Specify an operating voltage code in place of ③ in the Type No. 16: Transformer (100/110V AC) 116: Transformer (115V AC) 126: Transformer (120V AC) 26: Transformer (200/220V AC) 236: Transformer (230V AC) 246: Transformer (240V AC) 386: Transformer (380V AC) 46: Transformer (400/440V AC) 486: Transformer (480V AC)

- Full voltage types do not contain a lamp. Order LED or incandescent lamps separately. For lamps, see page 36.
- LED illuminated transformer type contains an LED lamp (LSTD-6②, rated voltage 6V AC/DC).
- Incandescent illuminated transformer types contain an incandescent lamp (LS-6, rated voltage 6V AC/DC).

• Contact Statuses of Push-Pull Switch

Contact	ø40mm Mushroom Push-Pull Switch	
	Push	Pull
1NO	○+○	○-○
1NC	●-●	●+●
1NO-1NC	○+○ ●-●	○-○ ●+●
2NO	○+○ ○+○	○-○ ○-○
2NC	●-● ●-●	●+● ●+●

Note: Push-pull switch can have a maximum of two contact blocks.

Ø22 TW Series Illuminated Pushbuttons

Dimensions (Operator)

Round Extended (non-marking/markung) ALW2 / ALW2B / AOLW2 / AOLW2B

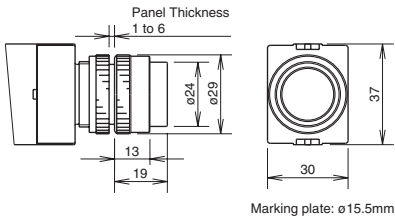

Round Extended with Full Shroud (non-marking/markung) ALFW2 / ALFW2B / AOLFW2 / AOLFW2B

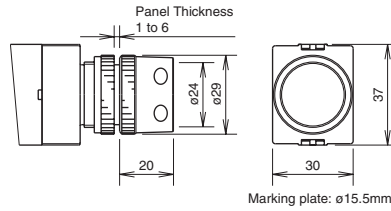

Square Extended (marking) ALQW2B / AOLQW2B

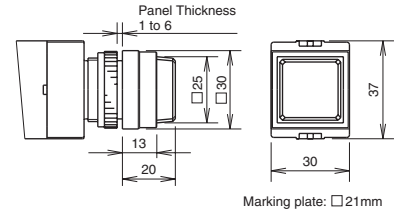

Ø29 Mushroom (non-marking/markung) ALW3 / ALW3B / AOLW3 / AOLW3B

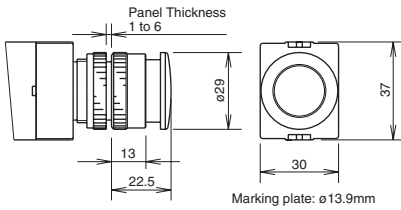

Ø29 Mushroom Pushlock Turn Reset (non-marking/markung) AVLW3 / AVLW3B

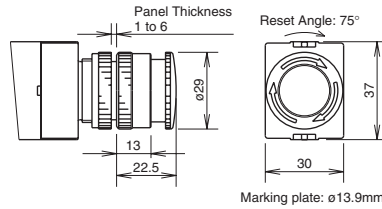

Ø40 Mushroom Pushlock Turn Reset (non-marking/markung) AVLW4 / AVLW4B

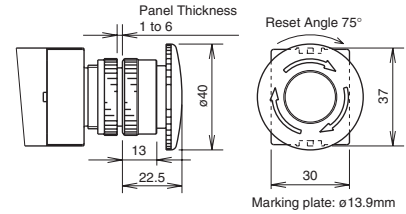

Ø40 Mushroom Push Pull (non-marking/markung) AYLW4 / AYLW4B

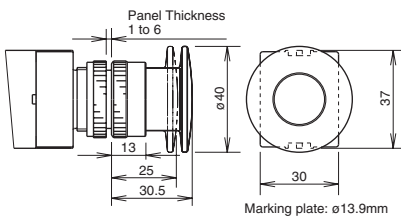

All dimensions in mm.

Terminal Arrangement (Lamp Terminal) (Bottom View)

• Arrows indicate access directions for wiring.

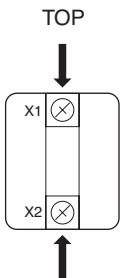

Full Voltage Type

When using TW-DA1B Full Voltage Adapter for 2 or 4 contact blocks

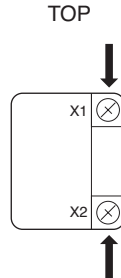

Full Voltage Type

When using HW-DA1B Full Voltage Adapter for 1 or 3 contact blocks

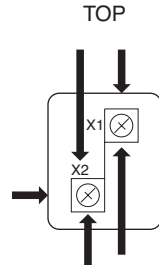

**Transformer Type
DC-DC Converter Type**

Dimensions (Behind the Panel)

• Full Voltage Type

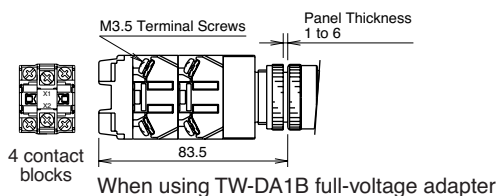
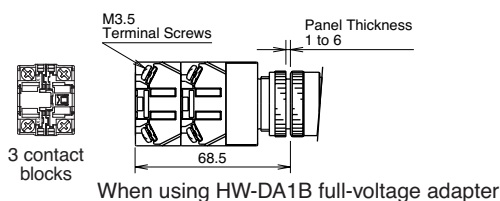
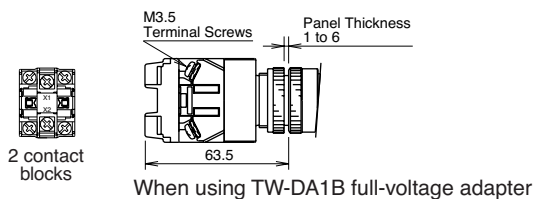
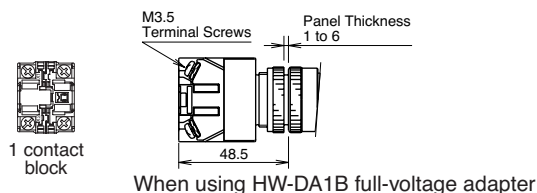

• Transformer Type • DC-DC Converter Type

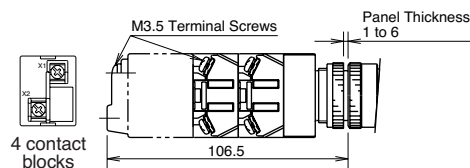
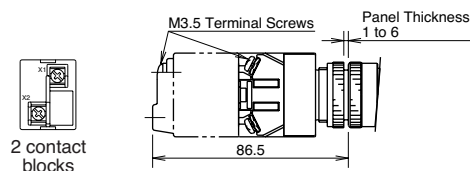

Note: For the push-pull type, a maximum of two contact blocks can be used.









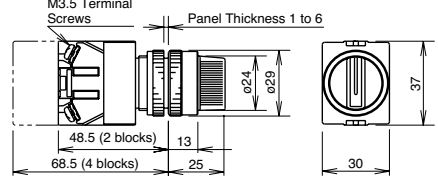

All dimensions in mm.

• Contact Configuration and Codes

Contact Configuration	Code	
1 block	1NO	10
	1NC	01
2 blocks	1NO-1NC	11
	2NO	20
3 blocks	2NO	02
	2NO-1NC	21
	1NO-2NC	12
	3NO	30
4 blocks	3NO	03
	3NO-1NC	31
	2NO-2NC	22
	1NO-3NC	13
	4NO	40
	4NC	04

ø22 TW Series Selector Switches

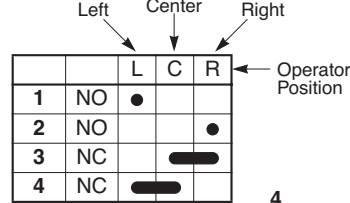
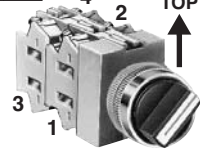
Selector Switches (Knob Operator Type)

No. of Positions	Shape			ASW							
	Contact Arrangement Chart			CE	UL LISTED	SP	 				
90° 2-position	Contact Code	Contact Block		Operator Position		Maintained	Spring Return from Right	Spring Return from Left	—		
		Mounting Position	Type	L	R				—		
	10 (1NO)	1	NO		●		ASW210	ASW2110	ASW2210 *	—	
		2	Dummy								
	11 (1NO-1NC)	1	NO		●		ASW211	ASW2111	ASW2211 *		
		2	NC	●							
	20 (2NO)	1	NO		●		ASW220	ASW2120	ASW2220 *		
		2	NO		●						
	22 (2NO-2NC)	1	NO		●		ASW222	ASW2122	ASW2222 *		
		2	NC	●							
	3	NO		●							
	4	NC	●								
45° 3-position	Contact Code	Contact Block		Operator Position			Maintained	Spring Return from Right	Spring Return from Left	Spring Return Two-way	
		Mounting Position	Type	L	C	R					
	20 (2NO)	1	NO	●			ASW320	ASW3120	ASW3220	ASW3320	
		2	NO			●					
	02 (2NC)	1	NC		■		ASW302	ASW3102	ASW3202	ASW3302	
		2	NC		■						
	22 (2NO-2NC)	1	NO	●			ASW322	ASW3122	ASW3222	ASW3322	
		2	NO			●					
		3	NC		■						
		4	NC		■						
	40 (4NO)	1	NO	●			ASW340	ASW3140	ASW3240	ASW3340	
		2	NO			●					
		3	NO	●							
		4	NO			●					
	04 (4NC)	1	NC		■		ASW304	ASW3104	ASW3204	ASW3304	
		2	NC		■						
		3	NC		■						
		4	NC		■						
	3S ★	1	NO	●			ASW33S-243 ★	—	—	—	
		2	NO			●					
3		NC		■							
4		Dummy									
30° 5-position / 45° 4-position	Contact Code	Contact Block		Operator Position					Maintained	Maintained	• Contact Block Mounting Position and Contact Arrangement Chart  • For more contact arrangement chart, see pages 27 to 29. 
		Mounting Position	Type	1	2	3	4	5			
	4S ★	1	NC		■					ASW44S-407 ★	—
		2	NC		●						
		3	NC			●					
		4	NO				●				
	4S ★	1	NO	●						ASW44S-411 ★	—
		2	NC		●						
		3	NC			●					
		4	NO				●				
	3S ★	1	NO	●						ASW43S-461 ★	—
		2	NC		●						
		3	NC			●					
		4	Dummy								
	4S ★	1	NO	●						—	ASW54S-501 ★
		2	NC		●						
3		NC			●						
4		NO				●					

• On the 2-position selector switches marked with * above, the contact operation is reversed as follows.

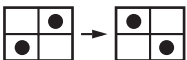

- On the contact arrangement marked with ★ in the table above, the rated current (load switching current) is reduced to a half of the rated current of the contact block. The rated insulation voltage and the rated thermal current remain unchanged.
- Selector switches with one or three contact blocks contain a dummy block.
- Knob operator: White indicator on black knob

Selector Switches (Lever Operator Type)

No. of Positions	Shape			ASW*L							
	Contact Arrangement Chart										
90° 2-position	Contact Code	Contact Block		Operator Position		Maintained	Spring Return from Right	Spring Return from Left	—		
		Mounting Position	Type	L	R				—		
	10 (1NO)	1	NO		●	ASW2L10	ASW21L10	ASW22L10 *	—		
		2	Dummy								
	11 (1NO-1NC)	1	NO		●	ASW2L11	ASW21L11	ASW22L11 *			
		2	NC	●							
	20 (2NO)	1	NO		●	ASW2L20	ASW21L20	ASW22L20 *			
		2	NO		●						
	22 (2NO-2NC)	1	NO		●	ASW2L22	ASW21L22	ASW22L22 *			
		2	NC	●							
	3	NO		●							
	4	NC	●								
45° 3-position	Contact Code	Contact Block		Operator Position			Maintained	Spring Return from Right	Spring Return from Left	Spring Return Two-way	
		Mounting Position	Type	L	C	R					
	20 (2NO)	1	NO	●			ASW3L20	ASW31L20	ASW32L20	ASW33L20	
		2	NO			●					
	02 (2NC)	1	NC			●	ASW3L02	ASW31L02	ASW32L02	ASW33L02	
		2	NC	●							
	22 (2NO-2NC)	1	NO	●			ASW3L22	ASW31L22	ASW32L22	ASW33L22	
		2	NO			●					
		3	NC			●					
		4	NC	●							
	40 (4NO)	1	NO	●			ASW3L40	ASW31L40	ASW32L40	ASW33L40	
		2	NO			●					
		3	NO	●							
		4	NO			●					
	04 (4NC)	1	NC			●	ASW3L04	ASW31L04	ASW32L04	ASW33L04	
		2	NC	●							
		3	NC			●					
		4	NC	●							
3S ★	1	NO	●			ASW3L3S-243 ★	—	—	—		
	2	NO			●						
	3	NC			●						
	4	Dummy									
30° 5-position / 45° 4-position	Contact Code	Contact Block		Operator Position					Maintained	Maintained	• Contact Block Mounting Position and Contact Arrangement Chart
		Mounting Position	Type	1	2	3	4	5			
	4S ★	1	NC			●				ASW4L4S-407 ★	—
		2	NC			●					
		3	NC				●				
		4	NO					●			
	4S ★	1	NO	●						ASW4L4S-411 ★	—
		2	NC			●					
		3	NC				●				
		4	NO					●			
	3S ★	1	NO	●						ASW4L3S-461 ★	—
		2	NC			●					
		3	NC				●				
		4	Dummy								
4S ★	1	NO	●						—	ASW5L4S-501 ★	
	2	NC			●						
	3	NC				●					
	4	NO					●				



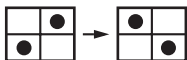





• On the 2-position selector switches marked with * above, the contact operation is reversed as follows.

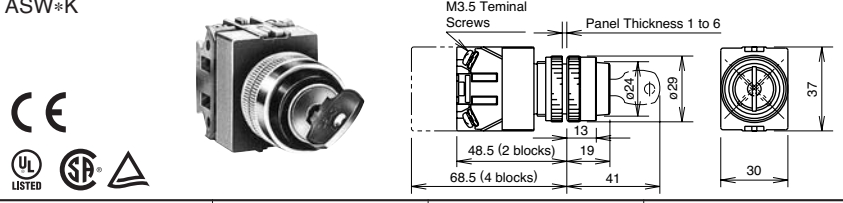

- On the contact arrangement marked with ★ in the table above, the rated current (load switching current) is reduced to a half of the rated current of the contact block. The rated insulation voltage and the rated thermal current remain unchanged.
- Selector switches with one or three contact blocks contain a dummy block.
- Lever operator: White indicator on black lever

ø22 TW Series Selector Switches

Key Selector Switches

No. of Positions	Shape			ASW*K						
	Contact Arrangement Chart									
90° 2-position	Contact Code	Contact Block		Operator Position		Maintained	Spring Return from Right	Spring Return from Left	—	
		Mounting Position	Type	L	R					
	10 (1NO)	1	NO		●	ASW2K10	ASW21K10	ASW22K10 *	—	
		2	Dummy							
	11 (1NO-1NC)	1	NO		●	ASW2K11	ASW21K11	ASW22K11 *		
		2	NC	●						
	20 (2NO)	1	NO		●	ASW2K20	ASW21K20	ASW22K20 *		
		2	NO		●					
	22 (2NO-2NC)	1	NO		●	ASW2K22	ASW21K22	ASW22K22 *		
		2	NC	●						
3		NO		●						
4		NC	●							
45° 3-position	Contact Code	Contact Block		Operator Position			Maintained	Spring Return from Right	Spring Return from Left	Spring Return Two-way
		Mounting Position	Type	L	C	R				
	20 (2NO)	1	NO	●			ASW3K20	ASW31K20	ASW32K20	ASW33K20
		2	NO			●				
	02 (2NC)	1	NC			●	ASW3K02	ASW31K02	ASW32K02	ASW33K02
		2	NC			●				
	22 (2NO-2NC)	1	NO	●			ASW3K22	ASW31K22	ASW32K22	ASW33K22
		2	NO			●				
		3	NC			●				
		4	NC			●				
	40 (4NO)	1	NO	●			ASW3K40	ASW31K40	ASW32K40	ASW33K40
		2	NO			●				
		3	NO	●						
		4	NO			●				
	04 (4NC)	1	NC			●	ASW3K04	ASW31K04	ASW32K04	ASW33K04
		2	NC			●				
		3	NC			●				
		4	NC			●				
	3S ★	1	NO	●			ASW3K3S-243 ★	—	—	—
		2	NO			●				
3		NC			●					
4		Dummy								

• On the spring-returned types, the key can be released only from the maintained position. On the maintained types, the key can be released from every position. Key retained positions are also available. See page 7.

• On the 2-position selector switches marked with * above, the contact operation is reversed as follows.

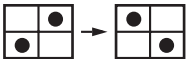

• On the contact arrangement marked with ★ in the table above, the rated current (load switching current) is reduced to a half of the rated current of the contact block. The rated insulation voltage and the rated thermal current remain unchanged.

• Key selector switches with one or three contact blocks contain a dummy block.

• Cylinder cover: Black, Cylinder: Metal

Contact Block Mounting Position and Contact Arrangement Chart

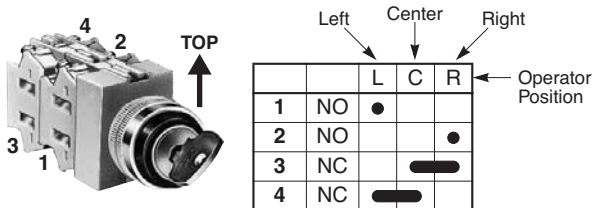

• For more contact arrangement chart, see pages 27 to 29.

Illuminated Selector Switches

90° 2-position

Shape		ASLW							
Contact Arrangement Chart									
Contact Code	Contact Block		Operator Position		Lamp	Input Type	Maintained	Spring Return from Right	Spring Return from Left
	Mounting Position	Type	L	R					
11 (1NO-1NC)	1	NO		●	Without Lamp	Full Voltage	L R	L R	L R
	2	NC	●		LED	Transformer	L R	L R	L R
					Incandescent	Transformer	L R	L R	L R
20 (2NO)	1	NO		●	Without Lamp	Full Voltage	L R	L R	L R
	2	NO		●	LED	Transformer	L R	L R	L R
					Incandescent	Transformer	L R	L R	L R
22 (2NO-2NC)	1	NO		●	Without Lamp	Full Voltage	L R	L R	L R
	2	NC	●		LED	Transformer	L R	L R	L R
	3	NO		●					
	4	NC	●		Incandescent	Transformer	L R	L R	L R

• Color Code and Operating Voltage Code

LED Illuminated Type	Incandescent Illuminated Type	③ Operating Voltage Code
② Lens/LED Color Code	② Lens Color Code	
Specify a lens/LED color code in place of ② in the Type No. A: amber G: green PW: pure white R: red S: blue W: white Y: yellow	Specify a lens color code in place of ② in the Type No. A: amber G: green R: red S: blue W: white	Specify an operating voltage code in place of ③ in the Type No. 16: Transformer (100/110V AC) 156: Transformer (115V AC) 136: Transformer (120V AC) 26: Transformer (200/220V AC) 236: Transformer (230V AC) 256: Transformer (240V AC) 386: Transformer (380V AC) 46: Transformer (400/440V AC) 486: Transformer (480V AC)

- Full voltage types do not contain a lamp. Order LED or incandescent lamps separately. For lamps, see page 36.
- LED illuminated transformer type contains an LED lamp (LSTD-6②, rated voltage 6V AC/DC).
- Incandescent illuminated transformer types contain an incandescent lamp (LS-6, rated voltage 6V AC/DC).

• Contact Block Mounting Position and Contact Arrangement Chart

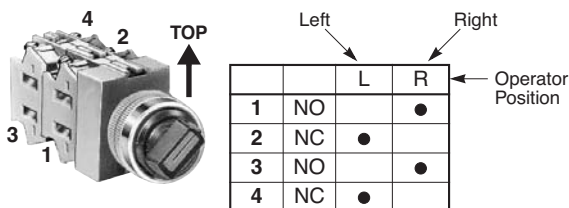

• For more contact arrangement chart, see pages 27 to 29.

ø22 TW Series Selector Switches

Illuminated Selector Switches

45° 3-position

Contact Code	Contact Block		Operator Position			Lamp Input Type	Maintained	Spring Return from Right	Spring Return from left	Spring Return Two-way
	Mounting Position	Type	L	C	R					
20 (2NO)	1	NO	●			Without Lamp Full Voltage	ASLW39920	ASLW319920	ASLW329920	ASLW339920
	2	NO			●	LED Transformer	ASLW3③20D②	ASLW31③20D②	ASLW32③20D②	ASLW33③20D②
						Incandescent Transformer	ASLW3③20②	ASLW31③20②	ASLW32③20②	ASLW33③20②
02 (2NC)	1	NC		■		Without Lamp Full Voltage	ASLW39902	ASLW319902	ASLW329902	ASLW339902
	2	NC	■			LED Transformer	ASLW3③02D②	ASLW31③02D②	ASLW32③02D②	ASLW33③02D②
						Incandescent Transformer	ASLW3③02②	ASLW31③02②	ASLW32③02②	ASLW33③02②
22 (2NO-2NC)	1	NO	●			Without Lamp Full Voltage	ASLW39922	ASLW319922	ASLW329922	ASLW339922
	2	NO			●	Without Lamp Full Voltage	ASLW39922	ASLW319922	ASLW329922	ASLW339922
	3	NC		■		LED Transformer	ASLW3③22D②	ASLW31③22D②	ASLW32③22D②	ASLW33③22D②
	4	NC	■			LED Transformer	ASLW3③22D②	ASLW31③22D②	ASLW32③22D②	ASLW33③22D②
					Incandescent Transformer	ASLW3③22②	ASLW31③22②	ASLW32③22②	ASLW33③22②	
40 (4NO)	1	NO	●			Without Lamp Full Voltage	ASLW39940	ASLW319940	ASLW329940	ASLW339940
	2	NO			●	Without Lamp Full Voltage	ASLW39940	ASLW319940	ASLW329940	ASLW339940
	3	NO	●			LED Transformer	ASLW3③40D②	ASLW31③40D②	ASLW32③40D②	ASLW33③40D②
	4	NO			●	LED Transformer	ASLW3③40D②	ASLW31③40D②	ASLW32③40D②	ASLW33③40D②
					Incandescent Transformer	ASLW3③40②	ASLW31③40②	ASLW32③40②	ASLW33③40②	
04 (4NC)	1	NC		■		Without Lamp Full Voltage	ASLW39904	ASLW319904	ASLW329904	ASLW339904
	2	NC	■			Without Lamp Full Voltage	ASLW39904	ASLW319904	ASLW329904	ASLW339904
	3	NC		■		LED Transformer	ASLW3③04D②	ASLW31③04D②	ASLW32③04D②	ASLW33③04D②
	4	NC	■			LED Transformer	ASLW3③04D②	ASLW31③04D②	ASLW32③04D②	ASLW33③04D②
					Incandescent Transformer	ASLW3③04②	ASLW31③04②	ASLW32③04②	ASLW33③04②	

• Color Code and Operating Voltage Code

LED Illuminated Type	Incandescent Illuminated Type	③ Operating Voltage Code
② Lens/LED Color Code	② Lens Color Code	
Specify a lens/LED color code in place of ② in the Type No. A: amber G: green PW: pure white R: red S: blue W: white Y: yellow	Specify a lens color code in place of ② in the Type No. A: amber G: green R: red S: blue W: white	Specify an operating voltage code in place of ③ in the Type No. 16: Transformer (100/110V AC) 156: Transformer (115V AC) 136: Transformer (120V AC) 26: Transformer (200/220V AC) 236: Transformer (230V AC) 256: Transformer (240V AC) 386: Transformer (380V AC) 46: Transformer (400/440V AC) 486: Transformer (480V AC)

- Full voltage types do not contain a lamp. Order LED or incandescent lamps separately. For lamps, see page 36.
- LED illuminated transformer type contains an LED lamp (LSTD-6②, rated voltage 6V AC/DC).
- Incandescent illuminated transformer types contain an incandescent lamp (LS-6, rated voltage 6V AC/DC).

• Contact Block Mounting Position and Contact Arrangement Chart

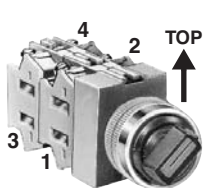

	Left	Center	Right	Operator Position
	L	C	R	
1	NO	●		
2	NO		●	
3	NC		■	
4	NC	■		

• For more contact arrangement chart, see pages 27 to 29.

TW Series Selector Switch Contact Arrangement Charts ø22

90° 2-position (Maintained / Spring Return)

Positions				Maintained	Spring Return from Right	Spring Return from Left	
Operator Types				Knob, Lever, Key, Illuminated			
Contact Code	Circuit No.	Mounting Position	Type	Operator Positions			
			L	R	L	R	
10 (1NO)	—	1	NO		●	●	
		2	Dummy				
01 (1NC)	—	1	NC	●			●
		2	Dummy				
11 (1NO-1NC)	—	1	NO		●	●	
		2	NC	●			●
	103	1	NC	●			●
		2	NO		●	●	
20 (2NO)	—	1	NO		●	●	
		2	NO		●	●	
02 (2NC)	—	1	NC	●			●
		2	NC	●			●
22 (2NO-2NC)	—	1	NO		●	●	
		2	NC	●			●
		3	NO		●	●	
		4	NC	●			●
	109	1	NO		●	●	
		2	NC	●			●
		3	NO		●	●	
		4	NO		●	●	
	110	1	NC	●			●
		2	NO		●	●	
		3	NC	●			●
		4	NO		●	●	
	111	1	NO		●	●	
		2	NO		●	●	
		3	NC	●			●
		4	NC	●			●
117	1	NC	●			●	
	2	NO		●	●		
	3	NO		●	●		
	4	NC	●			●	
31 (3NO-1NC)	107	1	NC	●			●
		2	NO		●	●	
		3	NO		●	●	
		4	NO		●	●	
40 (4NO)	—	1	NO		●	●	
		2	NO		●	●	
		3	NO		●	●	
		4	NO		●	●	
2R ★	118 ★	1	NO		—————		
		2	NC	—————			
	168 ★	1	NO		—————		
		2	NC	—————			—————
	119 ★	1	NC	—————			
		2	NO		—————		
	169 ★	1	NC	—————			—————
		2	NO		—————		
4R ★	120 ★	1	NO		—————		
		2	NC	—————			
		3	NO		—————		
		4	NC	—————			
	170 ★	1	NO		—————		
		2	NC	—————			—————
		3	NO		—————		
		4	NC	—————			—————
	121 ★	1	NC	—————			
		2	NO		—————		
		3	NC	—————			
		4	NO		—————		
171 ★	1	NC	—————			—————	
	2	NO		—————			
	3	NC	—————				
	4	NO		—————			

• Contact Block Mounting Position and Contact Arrangement Chart

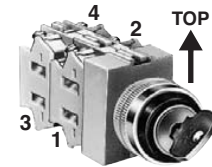

		Left	Right
		L	R
1	NO		●
2	NC	●	
3	NO		●
4	NC	●	

← Operator Position

• On the contact arrangement marked with ★ in the table, the rated current (load switching current) is reduced to a half of the rated current of the contact block. The rated insulation voltage and the rated thermal current remain unchanged.

Type No. Development

• When circuit number is not required:

ASW 2 11

• When circuit number is required:

ASW 2 11 - 103

ø22 TW Series Selector Switch Contact Arrangement Charts

45° 3-position (Maintained / Spring Return)

Positions	Maintained	Spring Return from Right	Spring Return from Left	Spring Return Two-way
Operator Types	Knob, Lever, Key, Illuminated			

Contact Code	Circuit No.	Mounting Position	Type	Operator Positions		
11	202	1	NO	•		
		2	NC	—		
	203	1	NC		—	
		2	NO			•
	302	1	NO	•		•
		2	NC	—		
	303	1	NC		•	
		2	NO			•
20	—	1	NO	•		
		2	NO			•
	301	1	NO	•		•
		2	NO			•
02	—	1	NC		—	
		2	NC	—		
	304	1	NC		•	
		2	NC	—		
22 (2NO-2NC)	—	1	NO	•		
		2	NO			•
		3	NC		—	
		4	NC	—		
	210	1	NC		—	
		2	NO			•
		3	NC		—	
		4	NO			•
	308	1	NO	•		
		2	NC	—		
		3	NO	•		•
		4	NC	—		
	309	1	NO	•		•
		2	NC	—		
		3	NC		•	
		4	NO			•
310	1	NC		•		
	2	NO			•	
	3	NC		•		
	4	NO			•	
31 (3NO-1NC)	206	1	NO	•		
		2	NC	—		
	207	1	NC		—	
		2	NO			•
13	212	1	NO	•		
		2	NC	—		
		3	NC		—	
		4	NC	—		
	313	1	NC		•	
		2	NO			•
		3	NC		•	
		4	NC	—		
40	—	1	NO	•		
		2	NO			•
	305	1	NO	•		•
		2	NO			•
04	—	1	NC		—	
		2	NC	—		
		3	NC		—	
		4	NC	—		
	314	1	NC		•	
		2	NC	—		
		3	NC		•	
		4	NC	—		

• Contact Block Mounting Position and Contact Arrangement Chart

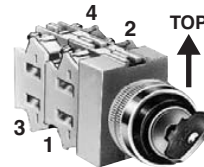

		Left	Center	Right	
		L	C	R	← Operator Position
1	NO	•			
2	NO			•	
3	NC		—		
4	NC	—			

Type No. Development

- When circuit number is not required:

ASW 3 22

└─ Contact Code (2NO-2NC)
└─ 3-position

- When circuit number is required:

ASW 3 22 - 210

└─ Circuit No.
└─ Contact Code (2NO-2NC)
└─ 3-position

TW Series Selector Switch Contact Arrangement Charts Ø22

45° 3-position (Maintained)

Positions				Maintained		
Operator Types				Knob, Lever, Key, Illuminated		
Contact Code	Circuit No.	Mounting Position	Type	Operator Positions		
				L	C	R
2S ★	1361 ★	1	NO	●		
		2	NC		●	
3S ★	243 ★	1	NO	●		
		2	NO			●
		3	NC		●	
		4	Dummy			
4S ★	233 ★	1	NO	●		
		2	NC	■		
		3	NO	●		●
		4	NO			●
	234 ★	1	NO	●		
		2	NC	■		
		3	NC		●	
		4	NC	■		
	235 ★	1	NC		■	
		2	NO			●
		3	NC		●	
		4	NO			●
237 ★	1	NO	●			
	2	NO			●	
	3	NC		●		
	4	NO			●	
240 ★	1	NC		■		
	2	NC	■			
	3	NC		●		
	4	NO			●	

45° 3-position (Maintained)

Positions				Maintained		
Operator Types				Knob, Lever, Illuminated		
Contact Code	Circuit No.	Mounting Position	Type	Operator Positions		
				L	C	R
4S ★	1336 ★	1	NO	●		
		2	NO			●
		3	NC		●	
		4	NC		●	
1337 ★	1	NC		●		
	2	NO			●	
	3	NC		■		
	4	NC		●		
1352 ★	1	NO	●			
	2	NC		●		
	3	NC		■		
	4	NO	●		●	
1355 ★	1	NO	●			
	2	NC		●		
	3	NO	●			
	4	NC		●		
1359 ★	1	NC		■		
	2	NC		●		
	3	NC		■		
	4	NC		●		

45° 4-position (Maintained)

Positions				Maintained			
Operator Types				Knob, Lever			
Contact Code	Circuit No.	Mounting Position	Type	Operator Positions			
				1	2	3	4
3S ★	461 ★	1	NO	●			
		2	NC		●		
		3	NC			●	
		4	Dummy				
4S ★	405 ★	1	NC		■		
		2	NC		●		
		3	NC			●	
		4	NC	■			
	407 ★	1	NC		■		
		2	NC		●		
		3	NC			●	
		4	NO				●
409 ★	1	NO	●				
	2	NC		●			
	3	NC				●	
	4	NC	■				
411 ★	1	NO	●				
	2	NC		●			
	3	NC			●		
	4	NO				●	

30° 5-position (Maintained)

Positions				Maintained				
Operator Types				Knob, Lever				
Contact Code	Circuit No.	Mounting Position	Type	Operator Positions				
				1	2	3	4	5
4S ★	501 ★	1	NO	●				
		2	NC		●			
		3	NC				●	
		4	NO					●

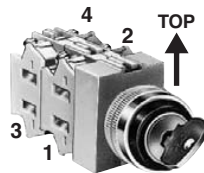





		Left	Center	Right	
		L	C	R	← Operator Position
1	NO	●			
2	NC		■		
3	NO	●		●	
4	NO			●	

• On the contact arrangement marked with ★ in the table, the rated current (load switching current) is reduced to a half of the rated current of the contact block. The rated insulation voltage and the rated thermal current remain unchanged.

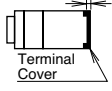
ø22 TW Series Accessories and Replacement Parts

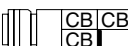
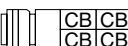
Accessories

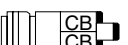
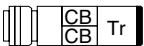

Terminal Cover		HW-VL2	HW-VL3	HW-VL4	HW-VL5	HW-VL6	APS-PVL	Use of terminal covers increases the depth by the dimensions below. 
Control Unit		39.8H × 14.1W	37.8H × 26W	39.8H × 8.7W	39.1H × 15.5W	40H × 14.8W	36H × 29.4W	
• Pilot light APW APQW	Full Voltage						X	+6mm
	Transformer DC-DC Converter		X					+3mm
				X				
• Pushbutton ABW ACW AVW ABQW ABFW AJW AOQW AOFW AXW ABGW AYW	1 contact block 	X						+3.5mm
	2 contact blocks 	X 2 pieces						
	3 contact blocks 	X 2 pieces						
	4 contact blocks 	X 2 pieces						
• Selector switch ASW	1 contact block	X						+3.5mm
	2 contact blocks	X 2 pieces						
• Illuminated pushbutton ALW AOLW ALFW AOLFW ALQW AOLQW AVLW AYLW	Full Voltage, 1 or 3 contact blocks 	X 2 pieces						+3.5mm
	Full Voltage, 2 or 4 contact blocks 			X For contact blocks 2 pieces	X For full voltage adapter			+3mm
• Illuminated selector switch ASLW	Transformer DC-DC Converter 		X					+3mm

• Ordering Terminal Covers

Terminal covers are ordered separately.
When ordering terminal covers, specify the Type No. and required quantity.

Nameplates

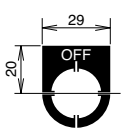
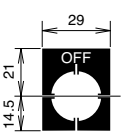
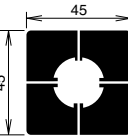
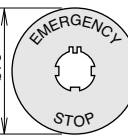
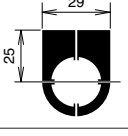
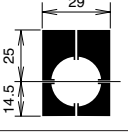
NWA, NWAQ, NWAQ, NWAQ, NWAQ, and NWAQ

Dimensions (mm)	Legend	Material	Type No.	Ordering Type No.	Package Quantity	Description
	Blank	Aluminium 0.8 mm thick	NWA-0	NWA-0	1	Black
	With Legend		NWA-*	NWA-0PN10	10	
				NWA-*	1	White letters on black background
				NWA-*PN10	10	
	Blank	Aluminium 0.8 mm thick	NWAQ-0	NWAQ-0	1	Black
	With Legend		NWAQ-*	NWAQ-0PN10	10	
				NWAQ-*	1	White letters on black background
				NWAQ-*PN10	10	
	Blank	Aluminium 0.8 mm thick	NWAQ-0	NWAQ-0	1	Black
				NWAQ-0PN10	10	
	Blank	Aluminium 0.8 mm thick	NWAR-0	NWAR-0	1	Yellow
	EMERGENCY STOP			NWAR-27	NWAR-0PN10	
			NWAR-27		1	Black letters on yellow back- ground
			NWAR-27PN10		10	
	Blank	Aluminium 0.8 mm thick	NWAQ-0	NWAQ-0	1	Black
				NWAQ-0PN10	10	
	Blank	Aluminium 0.8 mm thick	NWAQL-0	NWAQL-0	1	Black
				NWAQL-0PN10	10	
	Blank	Plastic	HWAV-0	HWAV-0	1	Yellow
	EMERGENCY STOP			HWAV-27	HWAV-27	1











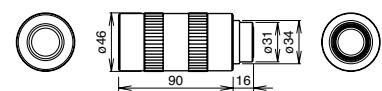

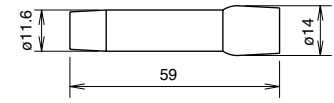

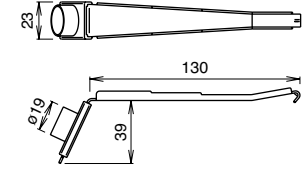
• Specify a legend code in place of * in the Ordering Type No.

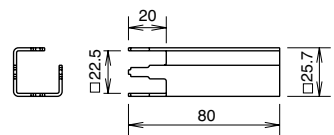

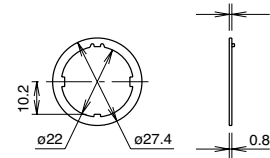

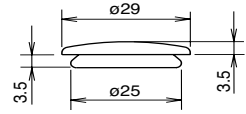

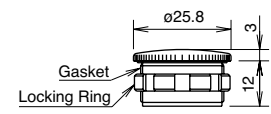

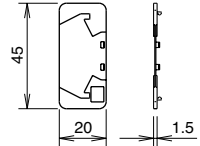
Legends

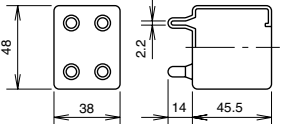
Code	Legend
0	(blank)
1	ON
2	OFF
3	START
4	STOP
31	OFF-ON
35	HAND-AUTO
53	HAND-OFF-AUTO

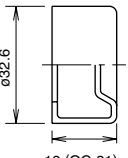
ø22 TW Series Accessories and Replacement Parts

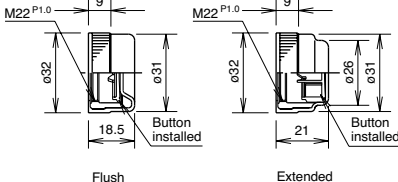
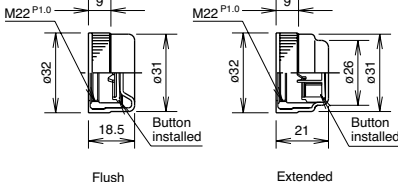
Accessories

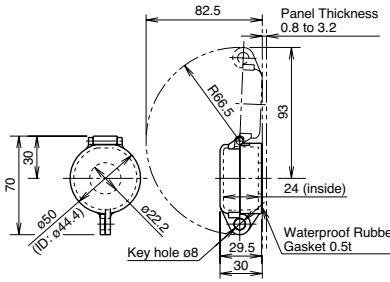
Shape	Material	Type No.	Ordering Type No.	Package Quantity	Dimensions
	Rubber	OR-14	OR-14	1	<ul style="list-style-type: none"> Used to tighten the locking ring when installing the TW control unit onto a panel.  <p>For ø22/ø25mm units For ø22mm units (close mounting)</p>
	Rubber	OR-55	OR-55	1	<ul style="list-style-type: none"> Used to install and remove LED/incandescent lamps. 
	Metal/Rubber	TW-KC1	TW-KC1	1	<ul style="list-style-type: none"> Used to remove contact blocks, transformers, lenses and adapters. Can also be used to determine panel thickness adjustment. 
	Metal	TW-KQ2	TW-KQ2	1	<ul style="list-style-type: none"> Used to tighten the locking nuts inside of the square bezel. This tool can be inserted into the OR-14 locking ring wrench. 
	Metal	OGL-31	OGL-31PN10	10	<ul style="list-style-type: none"> Used to prevent the operator from rotating. Generally used when using no nameplates on selector switches. 
	Rubber (black)	OB-31	OB-31PN05	5	<ul style="list-style-type: none"> Used to plug unused ø22.2mm mounting holes. 
	Diecast Metal (locking ring: plastic)	LW9Z-BM	LW9Z-BM	1	<ul style="list-style-type: none"> Used to plug unused ø22.2mm mounting holes. Tightening torque: 1.2 N·m Degree of protection: IP66 (without the 3.2mm recess in the mounting hole) 
	Plastic	HW-VL1	HW-VL1PN10	10	<ul style="list-style-type: none"> Used to prevent contact between adjacent lead wires when units are mounted closely. Barriers should be always used in close mounting. 

Accessories						
Shape	Material	Type No.	Ordering Type No.	Package Quantity	Description	
	Rubber (nitril)	OCW-99	OCW-99	1	<ul style="list-style-type: none"> Oiltight rubber boot used for pushbuttons and selector switches. Temperature range: -5 to +60°C Black 	<ul style="list-style-type: none"> For 1 layer of contact blocks (2 contact blocks)
		OCW-299	OCW-299	1		
	Rubber (EPDM)	OC-31	OC-31	1	<ul style="list-style-type: none"> Used to cover and protect pushbuttons where units are subject to water splash. Not suitable for outdoor use or where the units are subject to oil splash. 	For flush pushbuttons (ABW1/AOW1)
		OC-32	OC-32	1		
	Rubber (nitril)	OCW-10①	OCW-10①	1	<ul style="list-style-type: none"> Metallic bezels covered with rubber boot to enhance waterproof and oiltight characteristics. Button is installed in the cover. Remove the button from the pushbutton before using the button cover. ①: B (black), G (green), R (red), Y (yellow) 	For flush pushbuttons (ABW1/AOW1)
		OCW-11①	OCW-11①	1		
	Polyarylate (gasket: nitril rubber)	HW9Z-KL1	HW9Z-KL1	1	<ul style="list-style-type: none"> Used to protect momentary and maintained pushbuttons, illuminated pushbuttons, knobs selector switches, and key selector switches. 	
	Plastic	ALW4L-②	ALW4L-②	1	<ul style="list-style-type: none"> Applicable unit: ALW3, AOLW3 	Non-marking Type
		ALW4LD-②	ALW4LD-②	1		<ul style="list-style-type: none"> Applicable unit: ALW3B, AOLW3B Marking plate is included
		ALW4BL-②	ALW4BL-②	1	②: G (green), R (red), S (blue)	
		ALW4BLD-②	ALW4BLD-②	1	②: A (amber), W (white)	②: G (green), R (red), S (blue), W (white)

Note: Specify a button color code or lens color code in place of ① or ② in the Ordering Type No.

ø22 TW Series Accessories and Replacement Parts







Accessories

Shape	Material	Type No.	Ordering Type No.	Package Quantity	Dimensions		
Plastic Bezel 	Plastic	① Flush	AW-RP1B	AW-RP1BPN05	5		
		② Extended	AW-FP1B	AW-FP1B	1		
		③ Extended (for illuminated pushbuttons)	AW-FP2B	AW-FP2B	1		
		④ Square round (for round pushbuttons)	AW-H1B	AW-H1B	1		
		⑤ Square	AW-Q1B	AW-Q1B	1		
Aluminium Bezel 	Aluminium	① Flush	AW-R1	AW-R1PN05	5		
		② Extended	AW-R1B	AW-R1B	1		Black
		③ Extended (for illuminated pushbuttons)	AW-F1	AW-F1	1		Aluminium color (standard)
		④ Mushroom	AW-G4	AW-G4	1		
		Selector Operator 	Plastic	① Knob	ASWHHY-②		ASWHHY-②PN02
② Lever	ASWHHL-②			ASWHHL-②PN02	2		
③ Round	ASWHHM-B			ASWHHM-BPN02	2	Black only	
④ Color Insert	TW-HC1②			TW-HC1②PN05	5	Specify a color code in place of ②. B (black), G (green), R (red), S (blue), W (white), Y (yellow)	
⑤ Illuminated selector	ASLWDDY-②			ASLWDDY-②	1	Specify a color code in place of ②. A (amber), W (white), Y (yellow)	
Metal Protector 	Metal	OLW-C	OLW-C	1	<ul style="list-style-type: none"> Used to protect flush pushbuttons from inadvertent operation. 		

Maintenance Parts

Shape	Specification	Type No.	Ordering Type No.	Package Quantity	Color		
					Housing	Push Rod	
	1NO contact	— / —	HW-C10	HW-C10	1	Blue	Green
	1NC contact	— / —	HW-C01	HW-C01	1	Purple red	Red
	EM contact (early make)	— / —	HW-C10R	HW-C10R	1	Blue	Black
	LB contact (late break)	— / —	HW-C01R	HW-C01R	1	Purple red	White
Dummy Block		TW-DB	TW-DBPN10	10	<ul style="list-style-type: none"> Used for non-illuminated units with 1NO or 1NC contact blocks. Black 		
Full Voltage Adapter (for 2 or 4 contact blocks)		TW-DA1B	TW-DA1BPN02	2	<ul style="list-style-type: none"> Adapter with M3.5 screws used for illuminated pushbutton or illuminated selector switch. Snaps on to the back of the contact block. Used with 2 or 4 contact blocks. Black 		
Full Voltage Adapter (for 1 or 3 contact blocks)		HW-DA1B	HW-DA1BPN02	2	<ul style="list-style-type: none"> Adapter with M3.5 screws used for illuminated pushbuttons or illuminated selector switch. Used with 1 or 3 contact blocks. Black 		

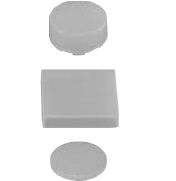
Maintenance Parts

Shape	Material	Type No.	Ordering Type No.	Package Quantity	Color Code
	AS	APW1L-②	APW1L-②PN05	5	G (green), R (red), S (blue)
		APW1LD-②	APW1LD-②PN05	5	A (amber), W (white), Y (yellow)
	AS, Marking type	APW11L-②	APW11L-②PN05	5	C (clear), G (green), R (red), S (blue)
		APW11LD-②	APW11LD-②PN05	5	A (amber), Y (yellow)
	AS	APW2L-②	APW2L-②PN05	5	G (green), R (red), S (blue)
		APW2LD-②	APW2LD-②PN05	5	A (amber), W (white), Y (yellow)
	AS, Marking type	APQW11L-②	APQW11L-②PN05	5	C (clear), G (green), R (red), S (blue)
		APQW11LD-②	APQW11LD-②PN05	5	A (amber), Y (yellow)
	AS	ALW2L-②	ALW2L-②PN05	5	G (green), R (red), S (blue)
		ALW2LD-②	ALW2LD-②PN05	5	A (amber), W (white), Y (yellow)
	AS, Marking type	ALW21L-②	ALW21L-②PN05	5	C (clear), G (green), R (red), S (blue)
		ALW21LD-②	ALW21LD-②PN05	5	A (amber), Y (yellow)
	AS	ALQW21L-②	ALQW21L-②PN05	5	C (clear), G (green), R (red), S (blue)
		ALQW21LD-②	ALQW21LD-②PN05	5	A (amber), Y (yellow)
	AS	ALW3L-②	ALW3L-②PN02	2	G (green), R (red), S (blue)
		ALW3LD-②	ALW3LD-②PN02	2	A (amber), W (white), Y (yellow)
	AS, Marking type	ALW31L-②	ALW31L-②PN02	2	C (clear), G (green), R (red), S (blue)
		ALW31LD-②	ALW31LD-②PN02	2	A (amber), Y (yellow)
AS, Marking type	AVLW31L-R	AVLW31L-RPN02	2		
AS	AVLW4L-R	AVLW4L-RPN02	2		
	Polyacetal	ABW1B-①	ABW1B-①PN05	5	B (black) G (green) R (red) S (blue) W (white) Y (yellow)
		ABW2B-①	ABW2B-①PN05	5	
		ABQW1B-①	ABQW1B-①PN05	5	
		ABQW2B-①	ABQW2B-①PN05	5	
		ABW3B-①	ABW3B-①PN02	2	
		ABW4B-①	ABW4B-①PN02	2	
		AVW3B-①	AVW3B-①PN02	2	R (red), Y (yellow)
		AVW4B-①	AVW4B-①PN02	2	R (red), Y (yellow)
		AYW4B-①	AYW4B-①PN02	2	B (black), G (green), R (red), S (blue), W (white), Y (yellow)
		APW2B	APW2BPN05	5	
		APQW1B	APQW1BPN05	5	
	Acrylic	ALW2B	ALW2BPN05	5	• White
		ALQW2B	ALQW2BPN05	5	
		ALW3B	ALW3BPN05	5	
	Acrylic	APW00LN	APW00LNPN05	5	
		APW00L	APW00LPN05	5	



Note: Specify a button color code or lens color code in place of ① or ② in the Ordering Type No.
Use a clear lens for white or pure white illumination.

ø22 TW Series Accessories and Replacement Parts





Maintenance Parts

Shape	Material	Type No.	Ordering Type No.	Package Quantity
 <p>Spare Key</p> <p>For Key Selector Switch For Pushlock Key Reset</p>	Metal	TW-SK-0	TW-SK-0PN02	2

LED Lamps (LSTD Type)

Operating Voltage	Current Draw		Type No.	Ordering Type No.	Illumination Color Code	Package Quantity	Base
	AC	DC					
 <p>6V AC/DC ±5%</p>	17 mA (A, R, W, Y) 8 mA (G, PW, S)	14 mA (A, R, W, Y) 5.5 mA (G, PW, S)	LSTD-6②	LSTD-6②	Specify a color code in place of ② in the Ordering Type No. A: amber G: green PW: pure white R: red S: blue W: white Y: yellow	1	BA9S/13
				LSTD-6②PN10		10	
 <p>12V AC/DC ±10%</p>	11 mA	10 mA	LSTD-1②	LSTD-1②		1	
				LSTD-1②PN10		10	
 <p>24V AC/DC ±10%</p>	11 mA	10 mA	LSTD-2②	LSTD-2②		1	
				LSTD-2②PN10		10	

Incandescent Lamps (LS Type)

Rated Operating Voltage	Lamp Ratings	Type No.	Package Quantity
 <p>6V AC/DC</p>	1W (6.3V)	LS-6	1
 <p>12V AC/DC</p>	1W (18V)	LS-8	
 <p>18V AC/DC</p>	1W (24V)	LS-2	
 <p>24V AC/DC</p>	1W (30V)	LS-3	

Transformer

Shape	Primary Voltage	Secondary Voltage	Type No.
 <p>Transformer Unit</p>	100/110V AC	5.5V	TW-T16B
	120V AC		TW-T126B
	200/220V AC		TW-T26B
	240V AC		TW-T246B

Safety Precautions

- Turn off the power to the TW series control units before starting installation, removal, wiring, maintenance, and inspection of the products. Failure to turn power off may cause electrical shocks or fire hazard.
- To avoid a burn on your hand, use the lamp holder tool when replacing lamps.
- For wiring, use wires of a proper size to meet the voltage and current requirements. Tighten the M3.5 terminal screws to a tightening torque of 1.0 to 1.3 N·m. Failure to tighten terminal screws may cause overheat and fire.

- Use HW-C type contact blocks for the TW series. Do not replace with or add conventional TW series contact blocks. Using a different type of contact block may lead to malfunction.

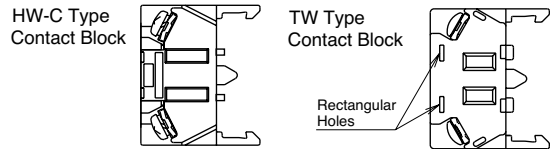

Instructions

Panel Mounting

Panel thickness adjustment ring is used for the TW series. To attach the TW series to the panel, follow the procedures below.

Mounting order		①Panel Thickness Adjustment	②Attaching the Unit to the Panel with the Bezel	③Attaching the Button, Lens, and Knob						
		 Panel thickness adjustment ring	 Panel	 Panel Lens						
Remarks			Attach the unit with the panel thickness scale facing up.	<table border="1"> <thead> <tr> <th>Type</th> <th>Method</th> </tr> </thead> <tbody> <tr> <td>Flush/Extended pushbuttons, Square lens, Selector operator</td> <td>Press in</td> </tr> <tr> <td>29mm/40mm mushroom button/lens, Dome lens</td> <td>Screw in</td> </tr> </tbody> </table>	Type	Method	Flush/Extended pushbuttons, Square lens, Selector operator	Press in	29mm/40mm mushroom button/lens, Dome lens	Screw in
Type	Method									
Flush/Extended pushbuttons, Square lens, Selector operator	Press in									
29mm/40mm mushroom button/lens, Dome lens	Screw in									
Tools	Locking ring wrench		For tightening or removing round bezels.							
	Nut locking wrench		For tightening or removing square bezels.							
	Contact block removal tool	Panel thickness adjustment	For installing or removing waterproof lenses after the bezel is attached.	For installing or removing round lenses.						

Adjusting Panel Thickness

The panel thickness ring provides adjustment from 1 to 6 mm in 1-mm increments. Set the panel thickness to line A. Rotate the ring until the desired thickness indication around the periphery is aligned with line A, as shown below.

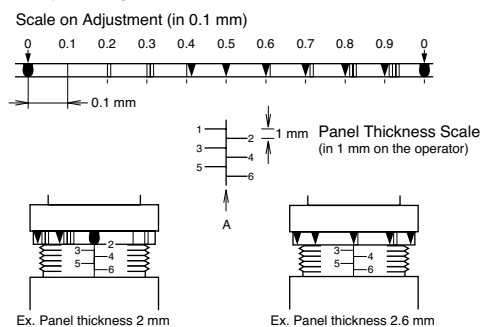

Note: When a nameplate or an anti-rotation ring is used, add 0.8mm to the panel thickness.

Total thickness
= Panel thickness + 0.8mm (nameplate or anti-rotation ring thickness)

Using the Contact Block Removal Tool to Adjust Panel Thickness

Panel thickness can easily be adjusted to the values shown below by inserting the contact block removal tool between the adjustment ring and base.

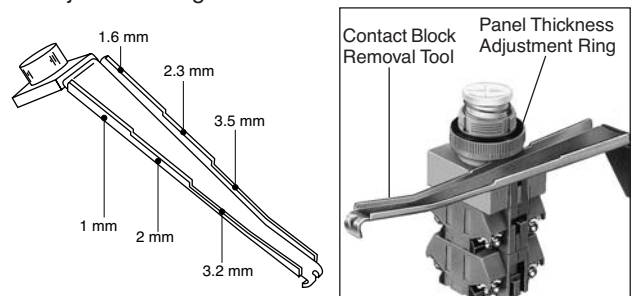

Instructions

Mounting into Panel Cut-out with Bezel

• Insertion into Panel Cut-out

Insert the base into the panel cut-out making sure that the panel thickness scale is facing up.

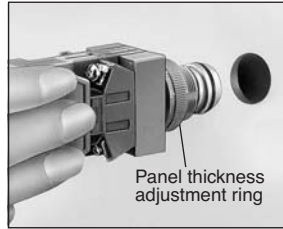

• Round Bezel

All round bezels are screw-in type. Be sure to use the locking ring wrench to tighten the bezel.

Locking Ring Wrench
OR-14 (optional)

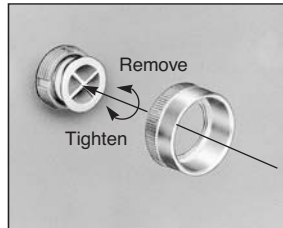
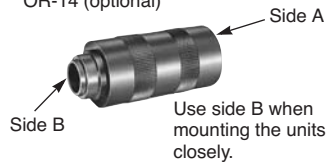

• Recommended tightening torque is 2.0 N·m.

• Square Bezel

1. Insert the base plate from the front.

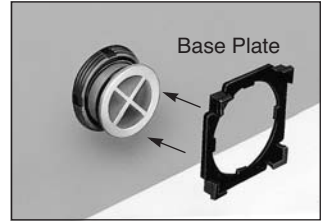

2. Insert the lock nut. For easy installation, use the nut locking wrench.



Nut Locking Wrench
TW-KQ2 (optional)



3. Mount the square bezel. The bezel will snap onto the base plate.

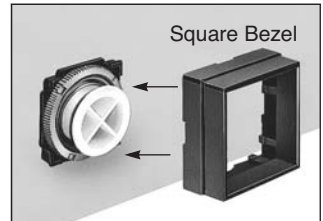

Installing Buttons, Lenses, and Operators

• Lens Structure and Marking Plate

All square lens units are marking types. To engrave on the marking plate, remove the marking plate from the lens.

[Square Pilot Lens]

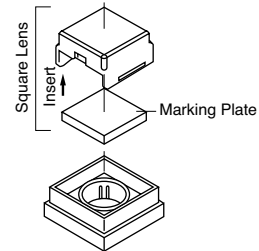

[Square Illuminated Pushbutton]

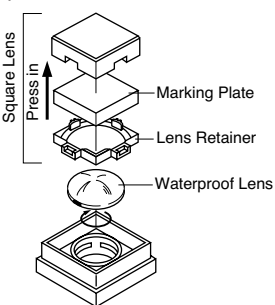

[Round Marking Type]

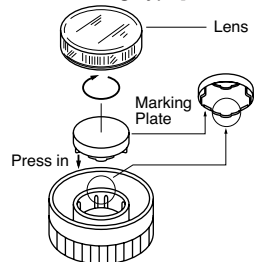

1. Removing the Square Lens

Insert the screwdriver into the recess of the lens and lightly push out the lens.

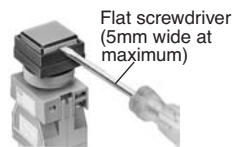

2. Removing the Marking Plate

• Pilot Light
Insert the screwdriver into the recess of the lens.

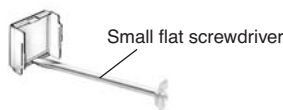

• Illuminated Pushbuttons
Insert the screwdriver into the hook and lightly push out the lens.

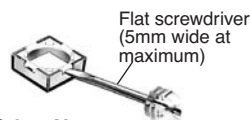

3. Other Notes

The square lens of the illuminated pushbutton cannot be used without waterproof lens. Always use the waterproof lens. Be sure to use the marking plate even when it is not engraved.

• Marking Plate Engraving Area

Round	Mushroom	Square (Pilot Light)	Square (Illuminated Pushbutton)

Note: The depth of the engraving must be within 0.5 mm.

• Installing Round Lens and Waterproof Lens

When installing or removing round lens of pilot lights and illuminated pushbuttons and waterproof lens of square pilot lights and illuminated pushbuttons, press the rubber part of the contact block removal tool onto the lens or waterproof lens for secure tightening and easy removal.

Instructions

• **Installation of Selector Operators**

1. The shaft of each selector or illuminated selector switch has a recess to identify in which direction to install the operator. Align the operator with the recess and press in the operator.
2. Press color insert (non-illuminated type) into the operator. The color insert retains the operator.

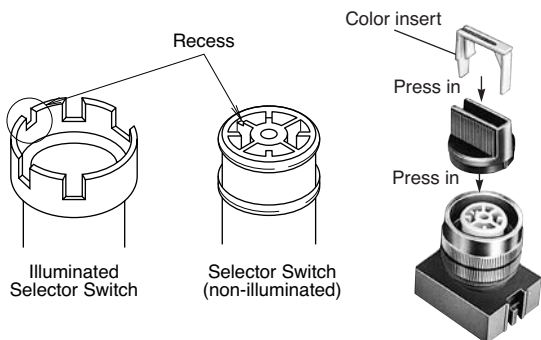

2-Position, 90°	3-Position, 45°	4-Position, 45°	5-Position, 30°

[Example]

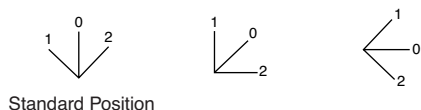

The non-illuminated operators can be installed in positions other than the standard position as shown above.

• **Removing the Operator**

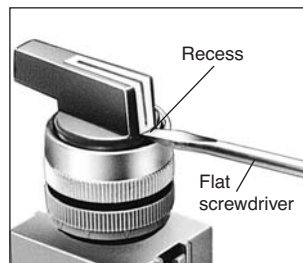

1. Removing the Color Insert

Insert a flat screwdriver into the recess of the color insert. Turn the screwdriver to push out the insert from the operator.

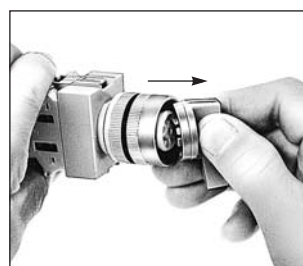

2. Removing the Operator (Non-illuminated)

Push the operator sideways as shown in the left photo to remove the operator.

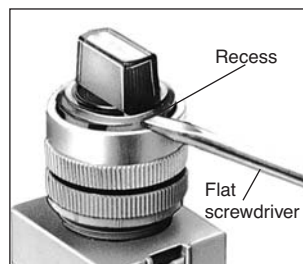

3. Removing the Operator (Illuminated)

Insert a flat screwdriver into the recess of the operator and turn the screwdriver to remove the operator.

Removing Contact Blocks, Transformers and Full Voltage Adapters

Insert the end of the contact block removal tool into the snap-fit latch of the contact block (or transformer, full-voltage adapter) and pull the tool as shown below.

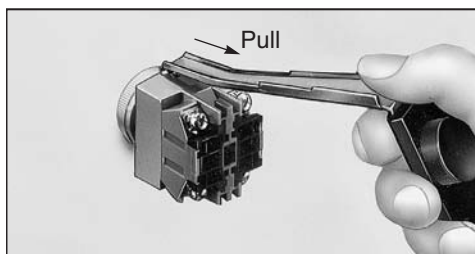

Collective Mounting

When mounting the units closely in a horizontal row on 30-mm centers, use optional barriers to prevent interconnection between adjoining terminals. The barriers can be attached simply by pressing them onto the sides of contact blocks.

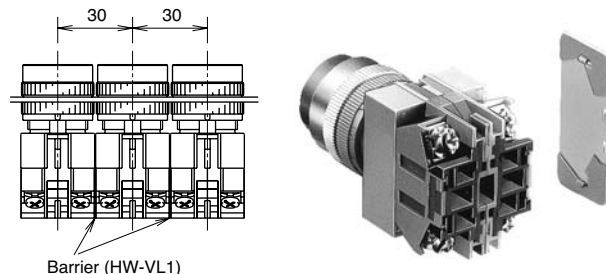

Tightening Torque for Terminal Screws

Tighten the M3.5 terminal screws to a torque of 1.0 to 1.3 N·m

022 TW Series Instructions

Installation of LED Illuminated Units

- Note the polarity for wiring when connecting to DC-DC converter unit.

Terminal No.	Polarity
X1	Positive
X2	Negative

- Transformer type units are recommended for use in areas subjected to noise.

Notes on LED Illuminated Units

LED lamps consist of semiconductors. If the applied voltage exceeds the rated voltage, LED elements may deteriorate due to overheat, resulting in significant decrease in luminance, hue change, or failure of lighting. Also, if an extraneous noise, transient voltage, or transient current is applied to the circuit, similar effects may occur. When using LED lamps, observe the following instructions.

• Rated Voltage

The LED lamps are rated at 6V, 12V, or 24V AC/DC, and can be used within $\pm 10\%$ the rated voltage of either AC or DC.

• DC Power

- Switching power supply
Regulated voltage from switching power supply is best suited. Make sure to use within the rated voltage of the LED lamp.
- Rechargeable battery
Note that the battery voltage may exceed the rated voltage of the LED lamp while the battery is being charged and immediately after the charging is complete. Be sure to use the LED lamp on a voltage of $\pm 10\%$ the rated voltage.
- Full-wave rectification
Since the LED lamp is AC/DC compatible, a diode bridge for rectification is not necessary. If the LED lamp is used on a full-wave rectification current through a diode bridge, the rectifier diodes will reduce the voltage, resulting in lower luminance.
- Single-phase half-wave rectification
This is not suitable for the power source of LED lamps. Use constant-voltage DC power.

• Noise

LED elements deteriorate due to extraneous noise, resulting in significant decrease in luminance, hue change, or failure of lighting. When such effects are anticipated, take a protection measure shown below, such as RC elements or a surge absorber.

- Notes for Pure White LED Lamps

- Do not use the pure white LED outdoors, otherwise it will lead to the degradation of brightness and color. Do not remove or apply shock to the cap on the pure white LED lamp, otherwise it may break or damage the cap.
- For the pure white LED, use a white lens. The illumination color will be dull if a different color is used.

[Protection Example 1] For AC circuit

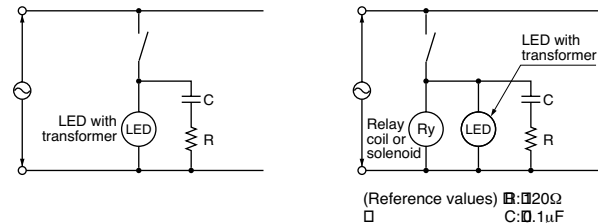

[Protection Example 2] For DC circuit

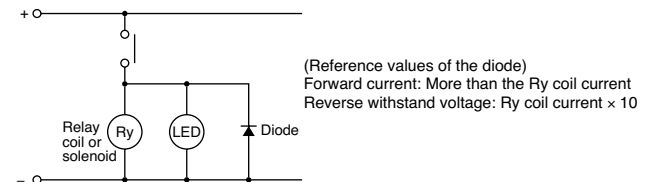

• Countermeasures against Dim Lighting

- Leakage currents through the transistors or a contact protection circuit may cause the LED lamp to illuminate dimly even when the output is off.
- When the LED lamp is illuminated by a transistor output, take the following measure.

[Circuit Example]

Connect shunt resistor R in parallel with the LED lamp.

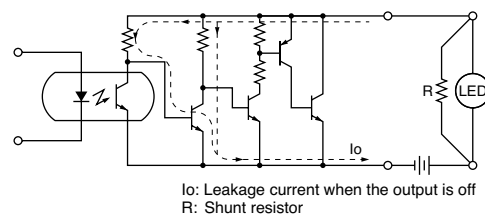

Specifications and other descriptions in this catalog are subject to change without notice.



IDEAC IZUMI CORPORATION

7-31, Nishi-Miyahara 1-Chome, Yodogawa-ku, Osaka 532-8550, Japan
Tel: +81-6-6398-2571, Fax: +81-6-6392-9731
www.idec.com

IDEAC CORPORATION (USA)
1175 Elko Drive, Sunnyvale, CA 94089-2209, USA
Tel: +1-408-747-0550, Toll Free: (800) 262-IDEAC, Fax: +1-408-744-9055
E-mail: opencontact@idec.com, www.idec.com

IDEAC CANADA LIMITED
Unit 22-151, Brunel Road Mississauga, Ontario, L4Z 1X3, Canada
Tel: +1-905-890-8561, Toll Free: (888) 317-4332, Fax: +1-905-890-8562

IDEAC ELECTRONICS LIMITED
Unit 2, Beechwood, Chineham Business Park, Basingstoke, Hampshire RG24 8WA, UK
Tel: +44-1256-321000, Fax: +44-1256-327755
E-mail: idec@uk.idec.com

IDEAC ELEKTROTECHNIK GmbH
Wendenstrasse 331, D-20537 Hamburg, Germany
Tel: +49-40-25 30 54 10, Fax: +49-40-25 30 54 24
E-mail: service@idec.de, www.idec.de

IDEAC AUSTRALIA PTY. LTD.
2/3 Macro Court, Rowville, Victoria 3178, Australia
Toll Free: 1-800-68-4332, Fax: +61-3-9763-3255
E-mail: sales@au.idec.com

IDEAC IZUMI ASIA PTE. LTD.
No. 31, Tannery Lane #05-01, Dragon Land Building, Singapore 347788
Tel: +65-6746-1155, Fax: +65-6844-5995
E-mail: generalinfo@idecasia.com.sg

IDEAC IZUMI (H.K.) CO., LTD.
Unit 1505-07, DCH Commercial Centre No. 25, Westlands Road, Quarry Bay, Hong Kong
Tel: +852-2803-8989, Fax: +852-2565-0171
E-mail: idec@idechk.com

IDEAC IZUMI (Shanghai) Co., Ltd.
Room E, 15F, Majesty Building, No. 138 Pudong Avenue, Shanghai 200120, P.R.C.
Tel: +86-21-5887-9181, Fax: +86-21-5887-8930
E-mail: idec@cn.idec.com

IDEAC TAIWAN CORPORATION
8F, No. 79, Hsin Tai Wu Road, Sec. 1, Hsi-Chih, Taipei County, Taiwan
Tel: +886-2-2698-3929, Fax: +886-2-2698-3931
E-mail: service@idectwn.com.tw