

Trouble-free discrete-wire termination with IDC Sockets that accommodate MIL Plugs.

- Two-slot, IDC construction and insulation barrel offer high reliability and large-current (3A) discrete wiring capability.
- Adaptable to a variety of covers for space-saving and discrete wire termination.
- By using the simple, unique lock-lever system, these Connectors can be locked to either the XG8B/XG8W Unshrouded Plugs (with right-angle terminals) or XG4C Box-type Plugs.
- Conforms to UL standards (file no. E103202). (Except for XG5S models)

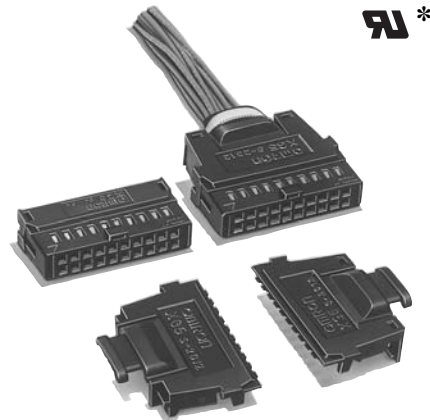

UL *

RoHS Compliant

* Excluding XG5S

Terminology

Insulation barrel

Refers to the part of a contact that crimps the insulating sheath of a wire.

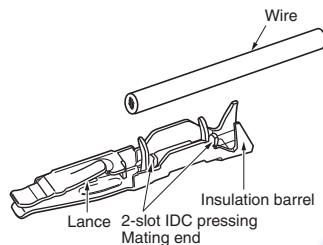

Insulation height

Refers to the height of the insulation barrel after crimping or IDC pressing.

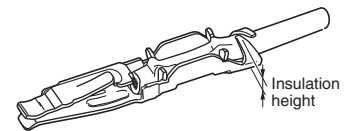

Lance

Refers to the lance-like projections arranged on a contact to secure it in the housing.

U-slot

Refers to the part where the wire and the contact connect to each other. It is called a U-slot because of its shape.

Construction

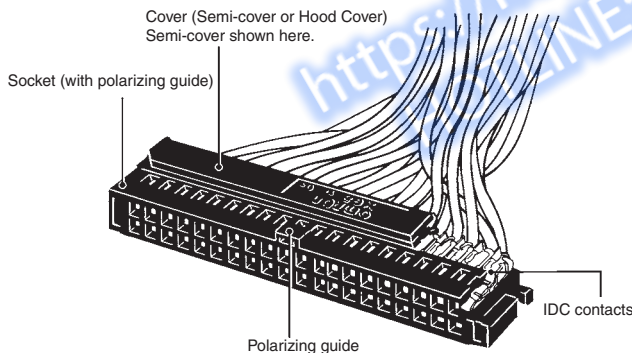

Solderless Contact

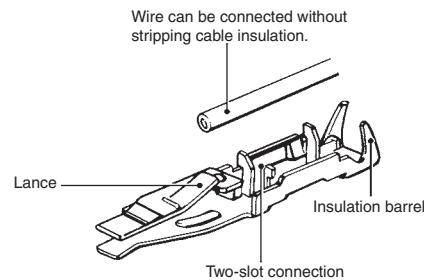

Ratings and Characteristics

Rated current	1 A (AWG28), 2 A (AWG26), 3 A (AWG24)
Rated voltage	300 VAC
Contact resistance	20 mΩ max. (at 20 mV, 100 mA max.)
Insulation resistance	1,000 MΩ min. (at 500 VDC)
Dielectric strength	650 VAC for 1 min (leakage current: 1 mA max.)
Total insertion force	1.96 N max. per contact
Removal force	0.29 N min. (with test gauge, 0.64 x 0.64 mm)
Insertion durability	50 times
Ambient operating temperature	-55 to 85°C (with no icing at low temperature)

Current and Temperature Characteristics

Use the temperature data shown below as a reference for selecting current values and wires.

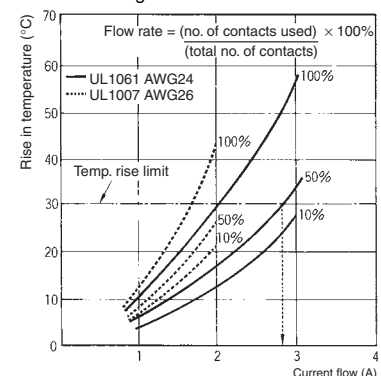
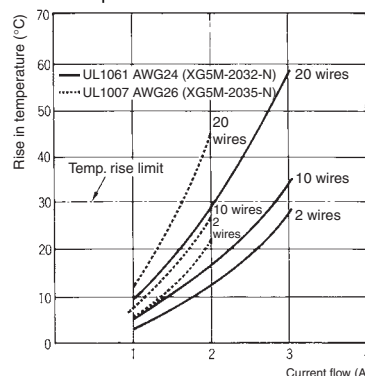

■ Materials and Finish

Housing		Fiber-glass reinforced PBT resin (UL94 V-0)/black
Contacts	Mating end	Phosphor-bronze/nickel base, 0.15- μ m gold plating
	Terminals	Phosphor-bronze/nickel base, 2.0- μ m solder plating
Cover		Fiber-glass reinforced polyamide resin (UL94 V-0)/black
Cable tie		Polyamide resin (UL94 V-0)/natural

■ Applicable Wires and Contact Sizes

Size #1	AWG24 (For UL1061)	Insulation outside diameter: 1.1 to 1.3 mm Core structure: 7 strands or more
Size #2	AWG28 or AWG26 (For UL1007)	

Note: The contact numbers are marked on the contact insulation barrels.

■ Configuration

Assembly

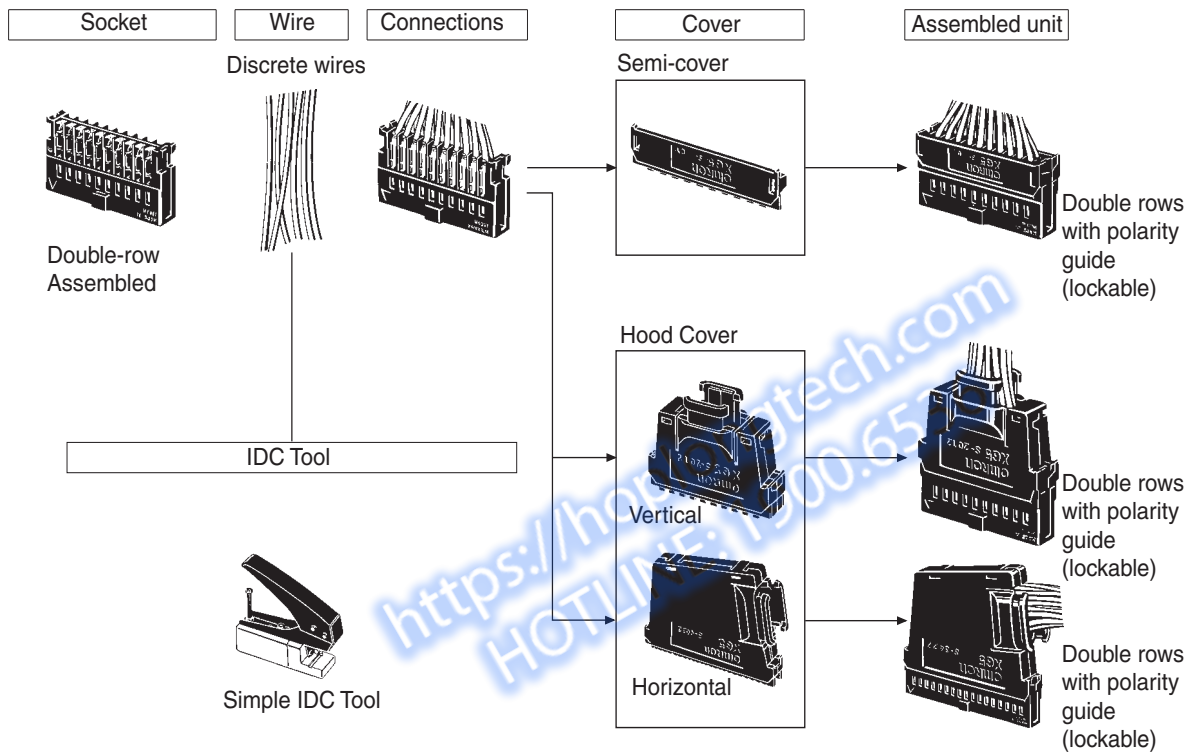

■ Applicable Plugs

XG4A Flat Cable MIL Plugs with Long Locks	XG4A Flat Cable Plugs without Lock Lever (Lock Levers mounted later)	XG4A Flat Cable Double-row Plugs
XG4E IDC Flat Cable Plugs Long Locks	XG4C Flat Cable Box-type Plugs	XG8W/XG8B Double-row Original Plugs

Note: 1. Plug dimensions are listed on the Plug's page.
2. When using the XG4A or XG4C, the number of XG4A or XG4C's slots must be the same as the number of XG5M-N polarity guides.

XG5M-N Double-row Sockets

■ Dimensions

(Unit: mm)

Models with no polarizing guide

XG5M-1031-N (size #1)

XG5M-1034-N (size #2)

Models with polarizing guide

XG5M-□□32-N (size #1)

XG5M-□□33-N (size #1)

XG5M-□□35-N (size #2)

XG5M-□□36-N (size #2)

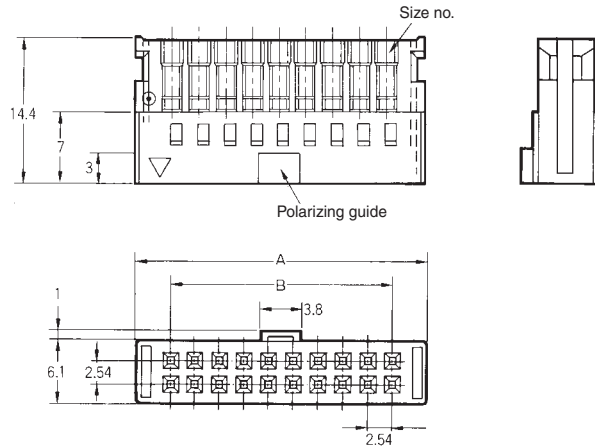
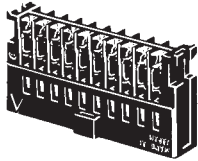

Dimensions

No. of contacts	Dimensions (mm)	
	A	B
10	17.3	10.16
14	22.3	15.24
16	24.9	17.78
20	30.0	22.86
26	37.6	30.48
30	42.7	35.56
34	47.7	40.64
40	55.4	48.26
50	68.1	60.96
60	80.8	73.66
64	85.8	78.74

■ Ordering Information

Appearance			
No. of contacts	No. of polarizing guide	Size #1 (See note 1.)	Size #2 (See note 2.)
10	0	XG5M-1031-N	XG5M-1034-N
	1	XG5M-1032-N	XG5M-1035-N
14	1	XG5M-1432-N	XG5M-1435-N
16	1	XG5M-1632-N	XG5M-1635-N
20	1	XG5M-2032-N	XG5M-2035-N
26	1	XG5M-2632-N	XG5M-2635-N
30	1	XG5M-3032-N	XG5M-3035-N
34	1	XG5M-3432-N	XG5M-3435-N
40	1	XG5M-4032-N	XG5M-4035-N
50	1	XG5M-5032-N	XG5M-5035-N
	2	XG5M-5033-N	XG5M-5036-N
60	1	XG5M-6032-N	XG5M-6035-N
	2	XG5M-6033-N	XG5M-6036-N
64	1	XG5M-6432-N	XG5M-6435-N
	2	XG5M-6433-N	XG5M-6436-N

Note: 1. The 10-contact XG5M-1031-N and XG5M-1034-N have no polarizing guides. The distance between slots is 22.86 mm for the two guides on 50, 60, and 64-contact Connectors.

2. See the previous page for Plug information.

3. Applicable wire is AWG24 (UL1061) for size #1.

4. Applicable wire is AWG28 to AWG26 (UL1007) for size #2. For details, see the previous page.

XG5S Semi-covers

■ Dimensions

(Unit: mm)

XG5S-□□01

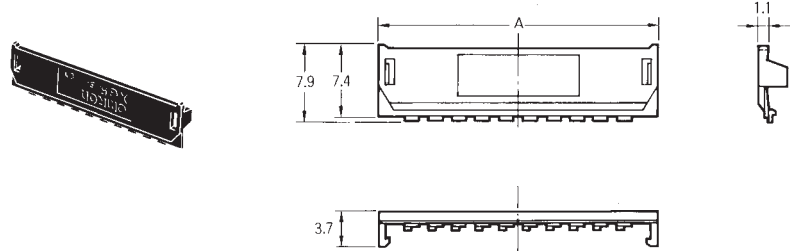

Dimensions

No. of contacts	Dimensions (mm)
	A
5	17.3
7	22.3
8	24.9
10	30.0
13	37.6
15	42.7
17	47.7
20	55.4
25	68.1
30	80.8
32	85.8

■ Ordering Information

No. of contacts	Model	Applicable Connector
5	XG5S-0501	XG5M-103□-N
7	XG5S-0701	XG5M-143□-N
8	XG5S-0801	XG5M-163□-N
10	XG5S-1001	XG5M-203□-N
13	XG5S-1301	XG5M-263□-N
15	XG5S-1501	XG5M-303□-N
17	XG5S-1701	XG5M-343□-N
20	XG5S-2001	XG5M-403□-N
25	XG5S-2501	XG5M-503□-N
30	XG5S-3001	XG5M-603□-N
32	XG5S-3201	XG5M-643□-N

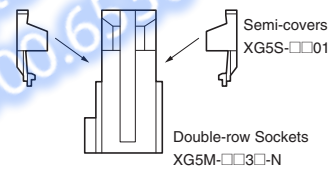

Note: One Semi-cover is used per row.
Each XG5M Connector requires two semi-covers.

■ Assembled Dimensions (Socket with Semi-cover)

Dimensions

No. of contacts	Dimensions (mm)	
	A	B
10	17.3	32.0
14	22.3	37.1
16	24.9	39.6
20	30.0	44.7
26	37.6	52.3
30	42.7	57.4
34	47.7	62.5
40	55.4	70.1
50	68.1	82.8
60	80.8	95.5
64	85.8	100.6

Original Plug + Semi-cover + Lock Lever

MIL Plug + Semi-cover

XG5S Hood Covers

■ Dimensions

(Unit: mm)

Vertical/XG5S-□□12
(Left and right halves)

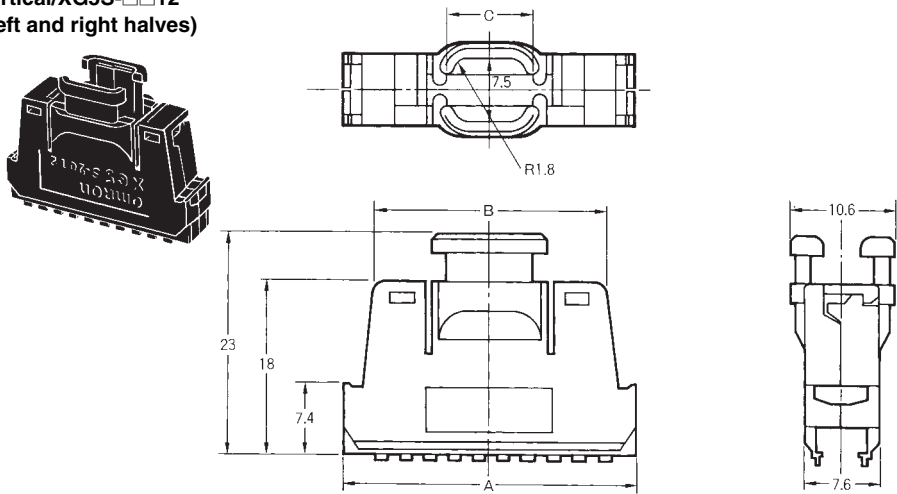

Dimensions

No. of contacts	Dimensions (mm)		
	A	B	C
20	30.0	23.8	8.8
26	37.6	31.4	11.4
30	42.7	36.5	15.1

Horizontal/XG5S-□□22
(Left and right halves)

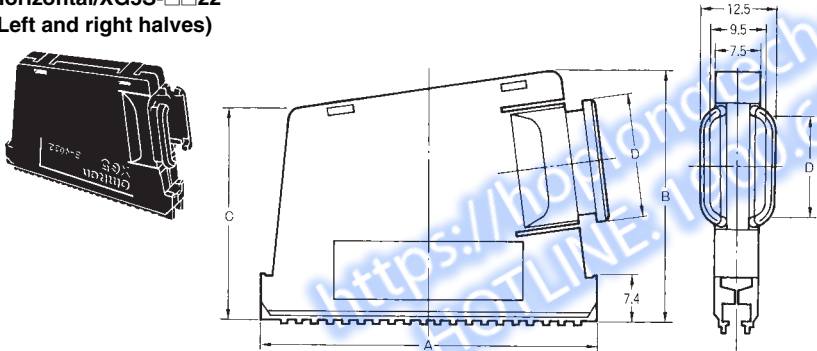

Dimensions

No. of contacts	Dimensions (mm)			
	A	B	C	D
34	47.7	38.7	32.0	14.6
40	55.4	40.7	34.0	16.6
50	68.1	44.1	39.4	20.0
60	80.8	47.4	42.8	23.4

■ Ordering Information

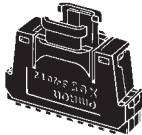
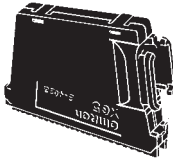
Appearance	Vertical	Horizontal
		
No. of contacts (double rows)	Model (See note.)	Model (See note.)
20	XG5S-2012	---
26	XG5S-2612	---
30	XG5S-3012	---
34	---	XG5S-3422
40	---	XG5S-4022
50	---	XG5S-5022
60	---	XG5S-6022

Note: Includes cable tie.

Assembled Dimensions (Socket and Hood Cover)

(Unit: mm)

Vertical Hood Cover

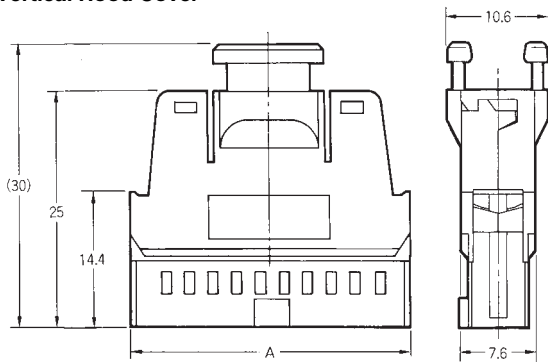

Dimensions

No. of contacts	Dimensions (mm)	
	A	B
20	30.0	44.7
26	37.6	52.3
30	42.7	57.4

Assembled Unit MIL Plug + Vertical Hood Cover

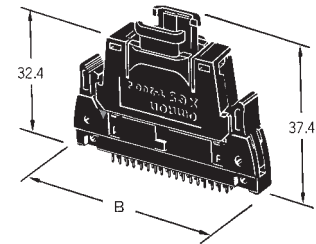

Horizontal Hood Cover

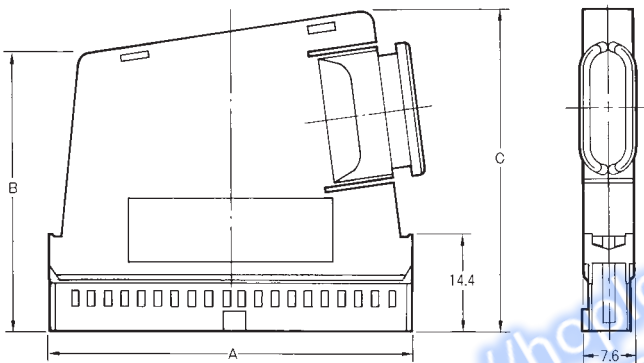

Assembled Unit MIL Plug + Horizontal Hood Cover

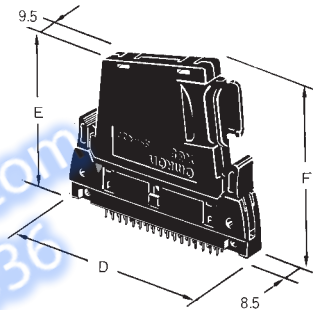

Dimensions

No. of contacts	Dimensions (mm)					
	A	B	C	D	E	F
34	47.7	39.0	45.7	62.5	46.4	53.1
40	55.4	41.0	47.7	70.1	48.4	55.1
50	68.1	46.4	51.1	82.8	53.8	58.5
60	80.8	49.8	54.4	95.5	57.2	61.8

■ XG5 Accessories (Sold Separately)

Lock Levers

XG5Z-0002

Use to lock Unshrouded Plugs (XG8B and XG8W, with right-angle terminals).

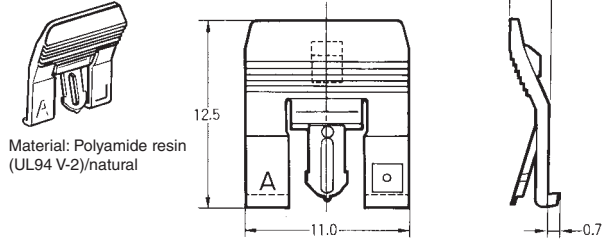

Lock Levers II

XG4Z-0002

Use to lock XG4C Box-type Plugs.

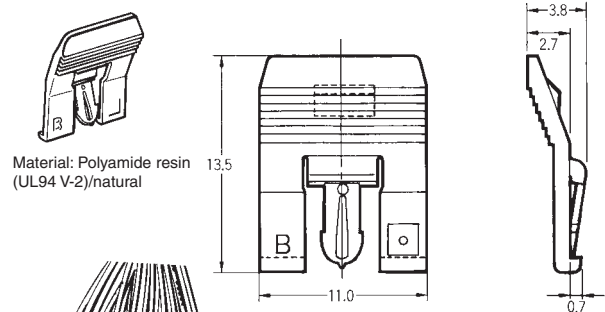

Mounting the Lock Lever

For Sockets with polarity guides, mount the Lock Lever to the tab to lock the Socket to the Unshrouded Plug as shown in the diagram on the right.

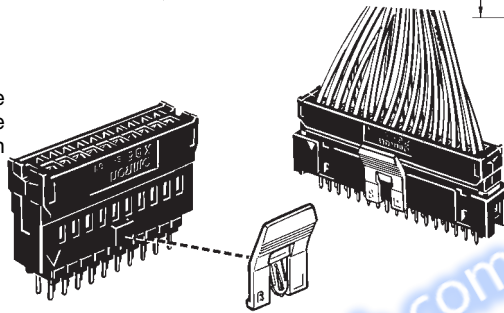

Model
XG5Z-0002
XG4Z-0002

Note: When you order the above products, order them in multiples of the minimum ordering quantity (pieces).

Spare Contacts

XG5W-0031-N (Size #1)

XG5W-0034-N (Size #2)

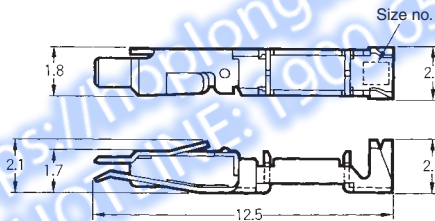

Model
XG5W-0031-N
XG5W-0034-N

- Note:**
- When you order the above products, order them in multiples of the minimum ordering quantity (pieces).
 - These Contacts can be used as replacements if a wrong connection is made.
 - The applicable wire for size No. 1 is AWG24 (UL1061). The applicable wire for size No. 2 is AWG28 to AWG26 (UL1007). See page 2 for details.

■ XG5 IDC Tools

Simple IDC Tool

XY2B-7006

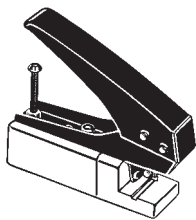

Model
XY2B-7006

This tool is a compact, light-weight model, ideal for use in the laboratory or for maintenance.

Specifications

Applicable connector	XG5M-N
Applicable wire	AWG24 to AWG28 (with an insulation outer diameter of 1.1 to 1.3 mm)
Dimensions	25 (W) × 100 (D) × 80 (H) mm
Weight	Approx. 180 g

■ Tools for the XG5 Contact Removal Tool

XY2E-0001

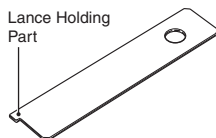

Model
XY2E-0001

Used to remove from the housing, contacts which are wrong.

Replacing Contacts

Use only this tool to remove incorrect IDC contacts.

1. Remove the cover.
2. Insert the tool into the housing lance holes and push the lance into the housing.
3. Pull out the contact while holding the lance down.
4. Insert a new contact.

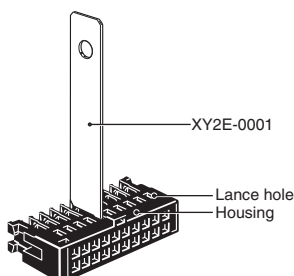

■ Tools

Simple Wire IDC Tool Set

XY2B-2104-N

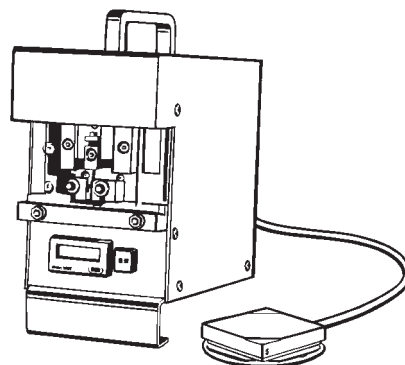

Model
XY2B-2104-N

This Wire IDC Tool Set is designed for XG5 Discrete-wire Connectors.

Specifications

Stroke	13 mm
Motor speed	83/100 rpm (50/60 Hz)
Feed pitch	2.54 mm
Operation	Foot switch
Weight	Approx. 6 kg
Rated voltage	0.5 A, 100 VAC (50/60 Hz)
Fuse	1 A
Dimensions	120 (W) × 225 (D) × 225 (H) mm

Note: For function and operation details, see the user's manual for the Pressure Welder provided separately.

Applicable Connectors and Wires

Applicable Connector	Size No.	Applicable wires			
		UL file No.	Size [No. of wires/diameter (mm)]	Cross-sectional area (mm ²)	Covering diameter (mm)
XG5M-□□31-N XG5M-□□32-N XG5M-□□33-N	No. 1	UL1061	AWG24 [7/0.203]	0.21	1.1
XG5M-□□34-N XG5M-□□35-N XG5M-□□36-N	No. 2	UL1007	AWG26 [7/0.16]	0.13	1.3
			AWG28 [7/0.127]	0.09	1.2

Note: Use only wires specified in the table above.

■ Precautions

Correct Use

IDC Connectors

- For best results, use only the XG5 IDC Tool.
- Contact your OMRON representative for details on the XG5 IDC Tool.
- Check the Contact size (No. 1 or No 2) and wire size before connecting.
- OMRON has a IDC Tool Reference Manual. Contact your OMRON representative to request a copy.

Mounting the Cover

- The cover is used to protect the connection position and prevent shorting out.

Mounting the Semi-cover

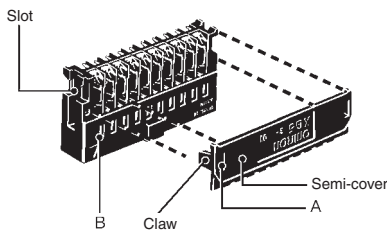

- See the above diagram.
1. Insert part A of the Semi-cover into part B of the Socket.
 2. Push the claws on both sides of the Semi-cover onto the Socket.
 3. Make sure the claws are firmly inserted in the slots.
 4. To protect the wires, use cable ties to bind wires that may be subject to tension even when a Semi-cover is used.

Mounting the Hood Cover

Vertical Hood Cover

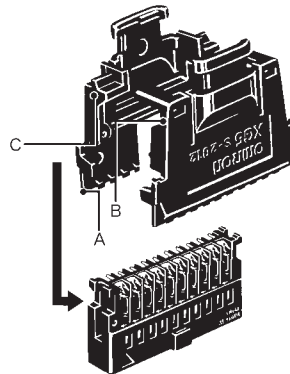

- See the above diagram.
1. Insert the claws of part A of the Hood Cover into the slots.
 2. Insert claws B on the Hood cover into part C on the other part of the Hood Cover.
 3. Wrap the wires with a cable tie.

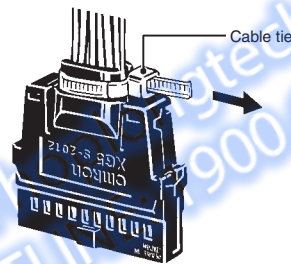

Horizontal Hood Cover

- Follow the mounting procedure for the vertical cover.
- The left and right parts of the cover are different. Assemble carefully.

XG5M-N Double-row Socket Contact Numbers

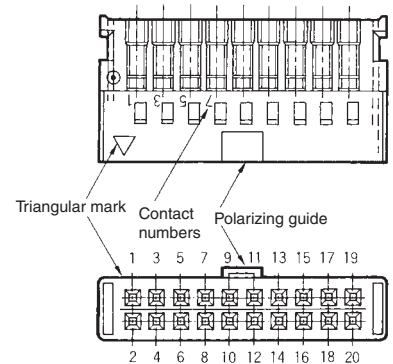

XG4M Contact Numbers

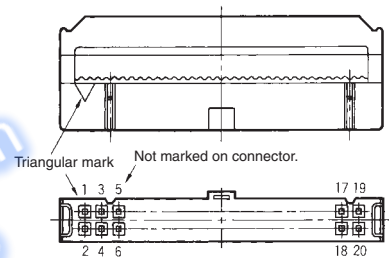

- The Contact numbers on the Double-row Assembled Socket match the numbers on the XG4M Flat Cable MIL Socket. (See the above diagrams.)
- When making IDC connections on the Double-row Assembled Connector, use the polarity guide to distinguish the front and back. (Note: The 10-contact Connector does not have a guide.)

Applicable Plugs

- XG4A, XG4C and XG8 are recommended.
- XG4C and XG8 Plugs do not have locks. To prevent accidental removal, use a Lock Lever (XG4Z-0002, XG5Z-0002). (Lock Levers cannot be used with XG8W Straight Terminal Connectors.)
- When mounting the XG8 Original Plug (with right-angle terminals) to a circuit board, be sure that the cover is positioned off the board as shown below.

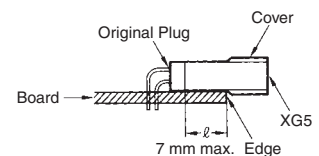

<https://hoplongtech.com>
HOTLINE: 1900.6536

- Application examples provided in this document are for reference only. In actual applications, confirm equipment functions and safety before using the product.
- Consult your OMRON representative before using the product under conditions which are not described in the manual or applying the product to nuclear control systems, railroad systems, aviation systems, vehicles, combustion systems, medical equipment, amusement machines, safety equipment, and other systems or equipment that may have a serious influence on lives and property if used improperly. Make sure that the ratings and performance characteristics of the product provide a margin of safety for the system or equipment, and be sure to provide the system or equipment with double safety mechanisms.

Note: Do not use this document to operate the Unit.