

**Allows High-density Mounting for Electronic Devices. A Half-Pitch Connector with a 1.27-mm Pitch for Compactness.**

- A pitch of 1.27 mm for high-density mounting of double-row arrangements.
- A quadruple-row staggered arrangement (1.27 mm x 1.905 mm) for board connection.
- Leaf contact construction enables smooth mating and resistance to bending.
- Space saving mating length of 3.1 mm.
- Press fitting assures long-term contact quality. The gold/palladium plating has been improved for better contact reliability.
- A special finish improves flux resistance (Straight Terminals only). Also it has fastening pins to standardize all the contacts.
- Can be mounted to boards with screws.
- The XH2 conforms to UL standards (file no. E103202).
- Not mated with XH3 and XH4 Half-pitch Connectors.

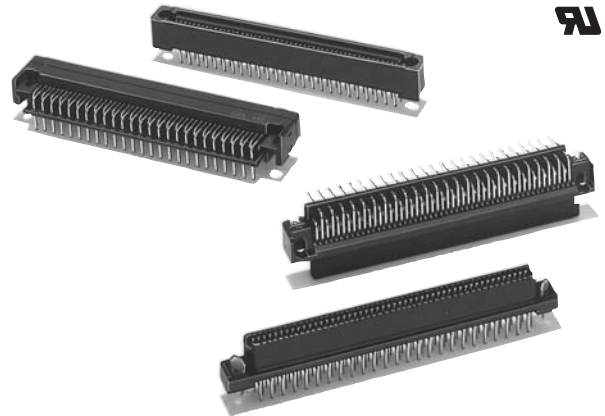

### RoHS Compliant

### ■ Ratings and Characteristics

Rated current	0.5 A
Rated voltage	125 VAC
Contact resistance (See note.)	30 mΩ max. (20 mV max., 100 mA max.)
Insulation resistance	1,000 MΩ min. (at 500 VDC)
Dielectric strength	650 VAC for 1 min (leakage current: 1 mA max.)
Total insertion force	0.78 N max. per contact
Total removal force	0.10 N min. per contact
Insertion durability	400 times
Ambient operating temperature	-55 to 105°C (with no condensation or icing)

**Note:** The contact resistance is for the XH2A-□□42 combined with the XH2B-□□41.

### ■ Materials and Finish

Type	Item	Plug	Socket
Housing		PBT (UL94 V-0)/black	
Locator		PBT (UL94 V-0)/black	
Contact	Mating end	Phosphor bronze/nickel base, gold/palladium plating	Phosphor bronze/nickel base, gold/palladium plating
	Terminal	Phosphor bronze/nickel base, tin plating	Phosphor bronze/nickel base, tin plating
Fastening pins		Copper alloy/tin plating	

# XH2A Plug, Straight DIP Terminals

## ■ Dimensions

(unit: mm)

### XH2A-□□41 (Straight DIP Terminals)

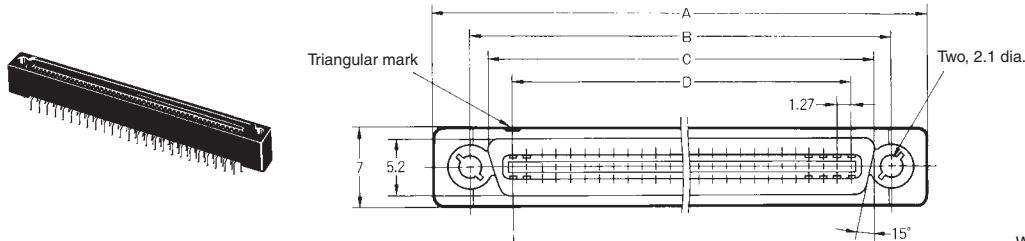

### XH2A-□□41-A (Straight DIP Terminals with Fastening Pins)

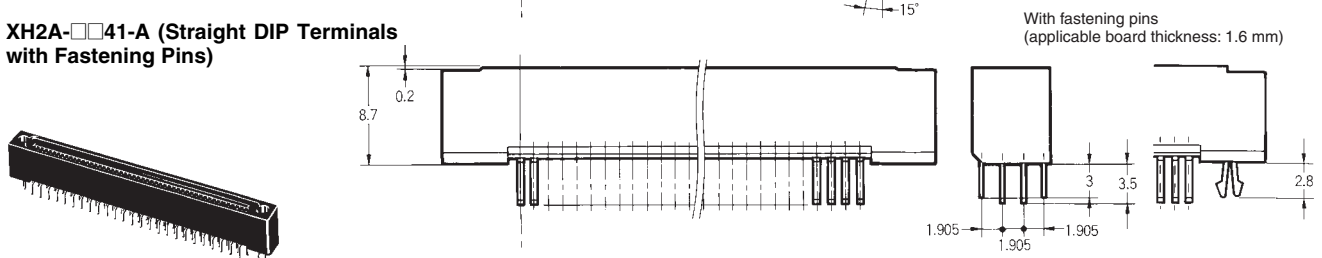

### Dimensions

Dimensions (mm)	A	B	C	D
No. of contacts				
20	25.4	19.05	15.8	11.43
30	31.8	25.40	22.2	17.78
40	38.1	31.75	28.5	24.13
50	44.5	38.10	34.9	30.48
60	50.8	44.45	41.2	36.83
68	55.9	49.53	46.3	41.91
80	63.5	57.15	53.9	49.53
100	76.2	69.85	66.6	62.23

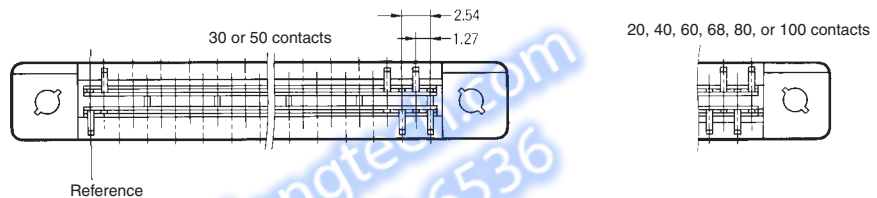

### Mounting holes (bottom view)

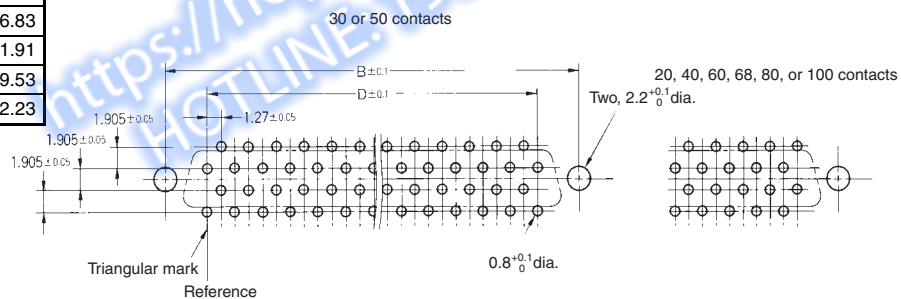

## ■ Ordering Information

Model	Plug/Straight DIP Terminals	Plug/Straight DIP Terminals with fastening pins (See note.)
No. of contacts		
20	XH2A-2041	XH2A-2041-A
30	XH2A-3041	XH2A-3041-A
40	XH2A-4041	XH2A-4041-A
50	XH2A-5041	XH2A-5041-A
60	XH2A-6041	XH2A-6041-A
68	XH2A-6841	XH2A-6841-A
80	XH2A-8041	XH2A-8041-A
100	XH2A-0141	XH2A-0141-A

Note: Applicable board thickness is 1.6 mm.

# XH2A Plug, Right-angle DIP Terminals

## ■ Dimensions

(unit: mm)

XH2A-□□42 (Right-angle DIP Terminals)

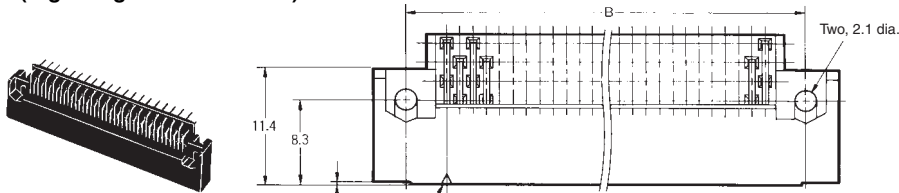

XH2A-□□42-A (Right-angle DIP Terminals with Fastening Pins)

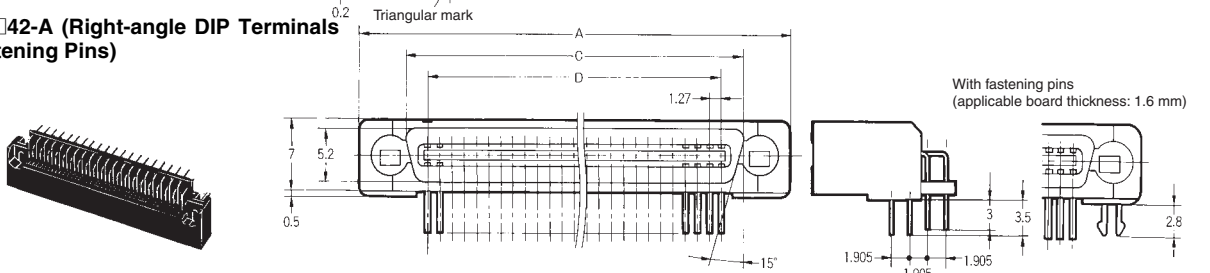

### Dimensions

Dimensions (mm)	A	B	C	D
No. of contacts				
20	25.4	19.05	15.8	11.43
30	31.8	25.40	22.2	17.78
40	38.1	31.75	28.5	24.13
50	44.5	38.10	34.9	30.48
60	50.8	44.45	41.2	36.83
68	55.9	49.53	46.3	41.91
80	63.5	57.15	53.9	49.53
100	76.2	69.85	66.6	62.23

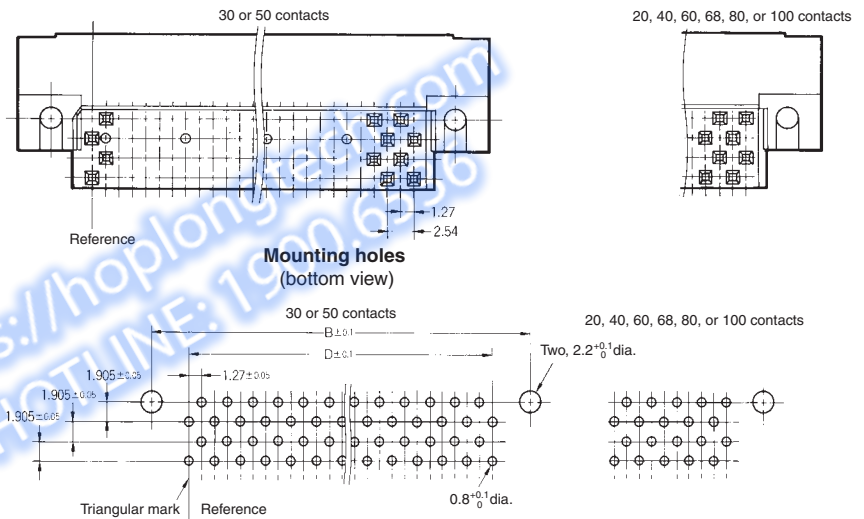

## ■ Ordering Information

Model	Plug/Right-angle DIP Terminals	Plug/Right-angle DIP Terminals with fastening pins (See note.)
No. of contacts		
20	XH2A-2042	XH2A-2042-A
30	XH2A-3042	XH2A-3042-A
40	XH2A-4042	XH2A-4042-A
50	XH2A-5042	XH2A-5042-A
60	XH2A-6042	XH2A-6042-A
68	XH2A-6842	XH2A-6842-A
80	XH2A-8042	XH2A-8042-A
100	XH2A-0142	XH2A-0142-A

**Note:** Applicable board thickness is 1.6 mm.

# XH2B Socket, Straight DIP Terminals

## ■ Dimensions

(unit: mm)

### XH2B-□□41 (Straight DIP Terminals)

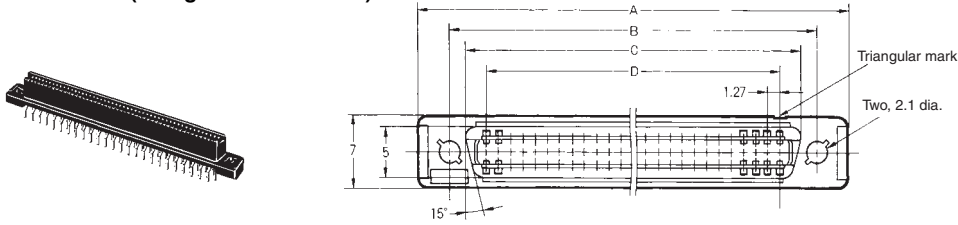

### XH2B-□□41-A (Straight DIP Terminals with Fastening Pins)

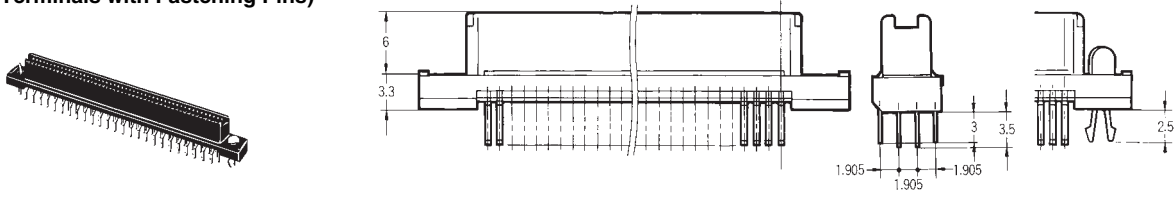

20, 40, 60, 68, 80, or 100 contacts

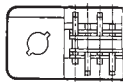

30 or 50 contacts

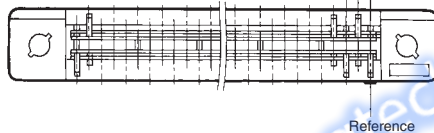

### Dimensions

Dimensions (mm)	A	B	C	D
No. of contacts				
20	25.4	19.05	15.7	11.43
30	31.8	25.40	22.1	17.78
40	38.1	31.75	28.4	24.13
50	44.5	38.10	34.8	30.48
60	50.8	44.45	41.1	36.83
68	55.9	49.53	46.2	41.91
80	63.5	57.15	53.8	49.53
100	76.2	69.85	66.5	62.23

### Mounting holes (bottom view)

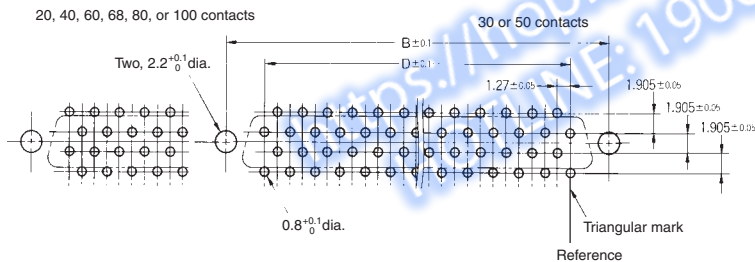

## ■ Ordering Information

Model	Socket/Straight DIP Terminals	Socket/Straight DIP Terminals with fastening pins (See note.)
No. of contacts		
20	XH2B-2041	XH2B-2041-A
30	XH2B-3041	XH2B-3041-A
40	XH2B-4041	XH2B-4041-A
50	XH2B-5041	XH2B-5041-A
60	XH2B-6041	XH2B-6041-A
68	XH2B-6841	XH2B-6841-A
80	XH2B-8041	XH2B-8041-A
100	XH2B-0141	XH2B-0141-A

**Note:** Applicable board thickness is 1.6 mm.

# XH2B Socket, Right-angle DIP Terminals

## ■ Dimensions

(unit: mm)

### XH2B-□□42 (Right-angle DIP Terminals)

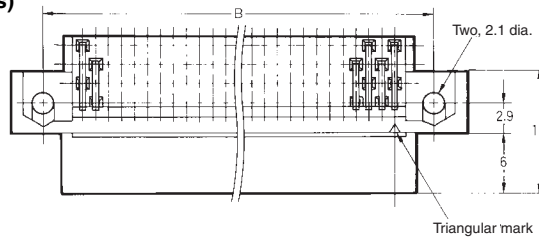
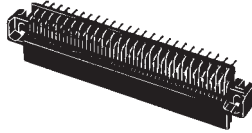

### XH2B-□□42-A (Right-angle DIP Terminals with Fastening Pins)

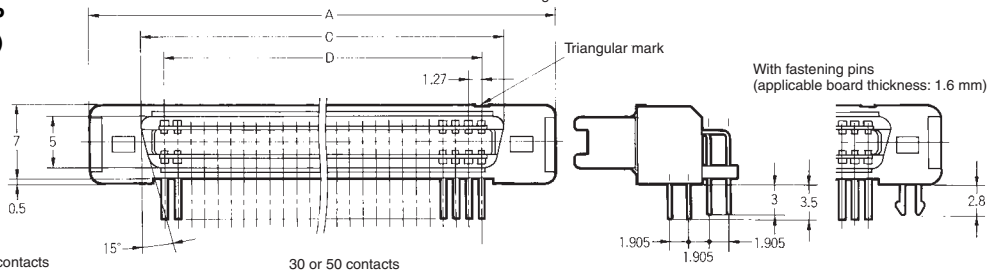
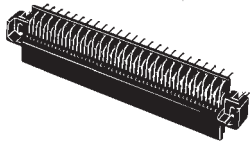

20, 40, 60, 68, 80, or 100 contacts

30 or 50 contacts

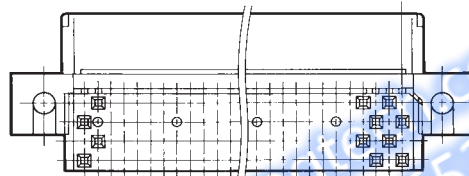
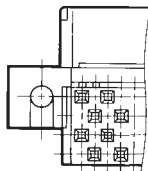

Mounting holes (bottom view)

20, 40, 60, 68, 80, or 100 contacts

30 or 50 contacts

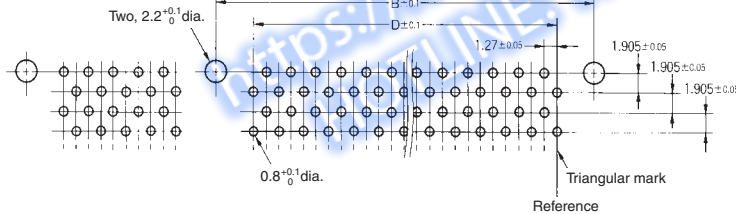

### Dimensions

Dimensions (mm)	A	B	C	D
No. of contacts				
20	25.4	19.05	15.7	11.43
30	31.8	25.40	22.1	17.78
40	38.1	31.75	28.4	24.13
50	44.5	38.10	34.8	30.48
60	50.8	44.45	41.1	36.83
68	55.9	49.53	46.2	41.91
80	63.5	57.15	53.8	49.53
100	76.2	69.85	66.5	62.23

## ■ Ordering Information

Model	Socket/Right-angle DIP Terminals	Socket/Right-angle DIP Terminals with fastening pins (See note.)
No. of contacts		
20	XH2B-2042	XH2B-2042-A
30	XH2B-3042	XH2B-3042-A
40	XH2B-4042	XH2B-4042-A
50	XH2B-5042	XH2B-5042-A
60	XH2B-6042	XH2B-6042-A
68	XH2B-6842	XH2B-6842-A
80	XH2B-8042	XH2B-8042-A
100	XH2B-0142	XH2B-0142-A

**Note:** Applicable board thickness is 1.6 mm.

## ■ Accessories (Sold Separately)

(unit: mm)

Dust Cover (material: ABS)  
 XH2T-□□01 (for Plug)  
 XH2T-□□02 (for Socket)

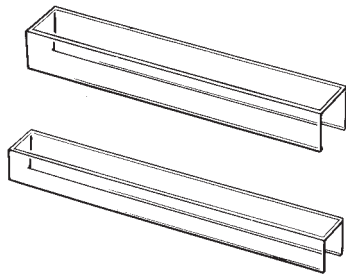

XH2T-□□01 (Transparent for Plug)

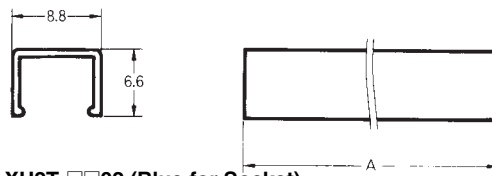

XH2T-□□02 (Blue for Socket)

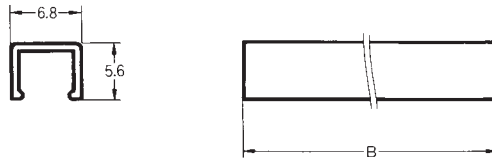

Attach these Dust Covers to Connectors that are not in use. They do not protect the Connectors from flux during automated soldering.

## ■ Ordering Information

Note: Order the following models in multiples of the minimum order.

No. of contacts	Model	XH2A (for Plug)		XH2B (for Socket)	
		Model	Dimensions A (mm)	Model	Dimensions B (mm)
20	XH2T-2001		25	XH2T-2002	15
30	XH2T-3001		31	XH2T-3002	21
40	XH2T-4001		37	XH2T-4002	27
50	XH2T-5001		44	XH2T-5002	34
60	XH2T-6001		50	XH2T-6002	40
68	XH2T-6801		55	XH2T-6802	45
80	XH2T-8001		63	XH2T-8002	53
100	XH2T-0101		75	XH2T-0102	65

## ■ Mating Diagram (Vertical/Horizontal/Stacking)

(unit: mm)

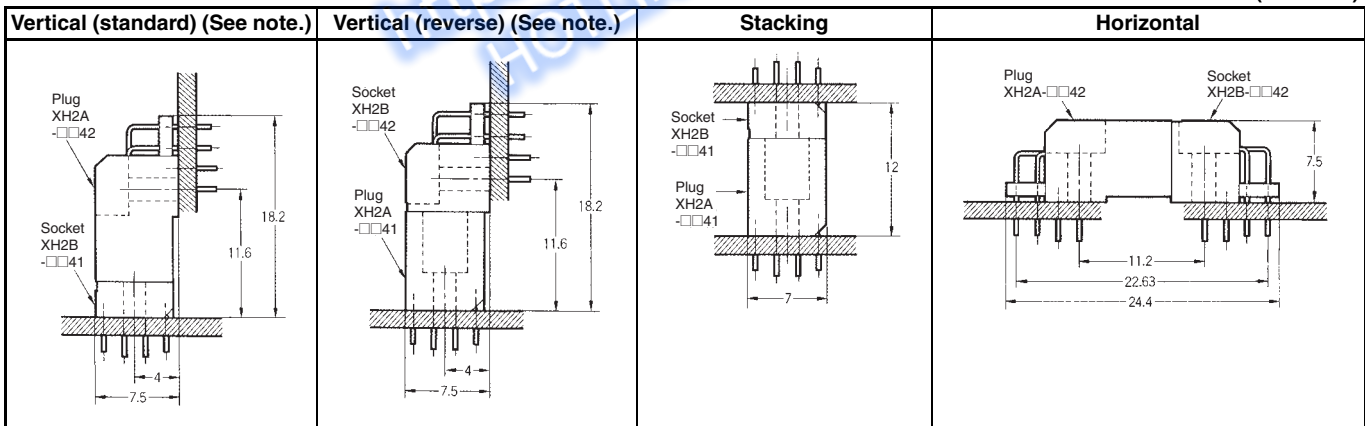

Note: The function of the standard and reverse models is the same as that of the standard XC5 DIN Connector.

## Contact Numbers

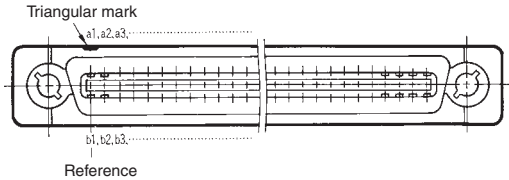
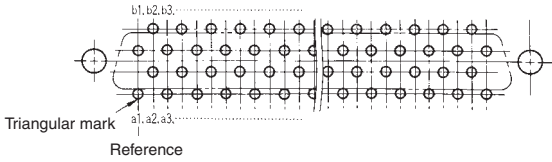
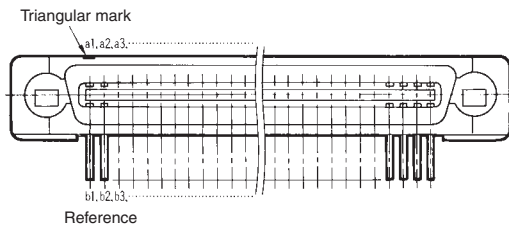
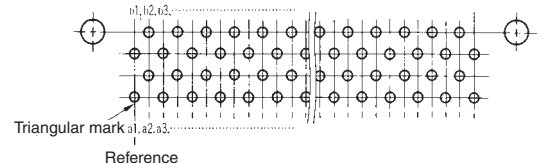
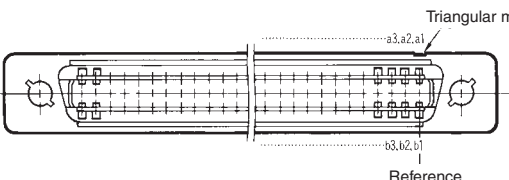
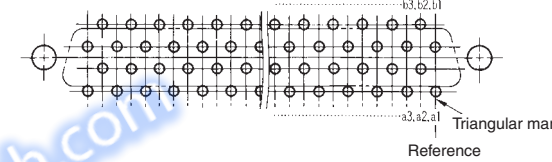
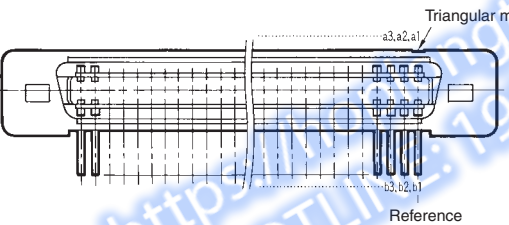
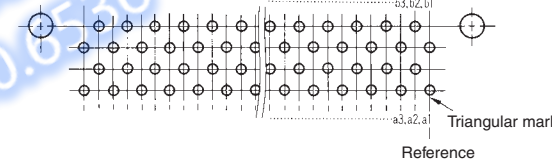
Item	Mated diagram	Mounting holes (bottom view)
Model Plug, Straight Terminals		
Plug, Right-angle Terminals		
Socket, Straight Terminals		
Socket, Right-angle Terminals		

- Contact numbers are not printed on the connectors. Use the triangular mark (▼) as a guide when designing and mounting to boards.

- On the mating side, the row of terminals on the triangular mark side are called row a, and the row on the other side is called row b. The numbers are in the order shown.

- The triangular marks on the plug and socket must be aligned when mated. The contact numbers on both sides must match.

## Precautions

### Correct Use

### Mating Compatibility

XH2 Half-pitch Connectors do not mate with XH3 or XH4 Half-pitch Connectors.

### Special Finish for Preventing Flux Rise

XH2 Connectors (i.e., Straight Terminals) have a special finish that prevents flux rise. (The Connectors are designed for automated soldering. Brush coating flux from the back of the board applies too much flux and may nullify the special finish. Never use this method to apply flux.)

### Soldering

Automated soldering

Use tape to mask the Right-angle Terminal Connector prior to automated soldering.

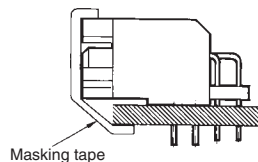

### Automated Soldering Conditions (Jet Flow)

- Soldering temperature: 250±5°C
- Continuous soldering time: Within 5±1 s

<https://hoplongtech.com>  
HOTLINE: 1900.6536

- Application examples provided in this document are for reference only. In actual applications, confirm equipment functions and safety before using the product.
- Consult your OMRON representative before using the product under conditions which are not described in the manual or applying the product to nuclear control systems, railroad systems, aviation systems, vehicles, combustion systems, medical equipment, amusement machines, safety equipment, and other systems or equipment that may have a serious influence on lives and property if used improperly. Make sure that the ratings and performance characteristics of the product provide a margin of safety for the system or equipment, and be sure to provide the system or equipment with double safety mechanisms.

**Note: Do not use this document to operate the Unit.**



### Screw Mount Eliminated to Save Space. Adjustable Stacking Space of 12 to 20 mm Adds Greater Flexibility.

- The stacking space can be adjusted from 12 to 20 mm in 1-mm increments.
- A pitch of 1.27 mm for high-density mounting in double-row arrangements.
- A quadruple-row staggered arrangement (1.27 x 1.905 mm) for board connection.
- All models incorporate fastening pins to secure the terminals, thus preventing floating or falling over during soldering.
- Leaf contact construction enables smooth mating and resistance to bending.
- Space saving mating length of 3.1 mm.
- Press fitting assures long-term contact quality. The gold/palladium plating has been improved for better contact reliability.
- The XH3 conforms to UL standards (file No. E103202).
- Not mated with XH2 and XH4 Half-pitch Connectors.

**RoHS Compliant**

### Terminology

#### Standard

To vertically connect the printed-wiring board, connect the socket straight terminal connector to the mother board (main board) side and connect the plug right-angle terminal connector to the daughter board (sub board) side.

#### Reverse

To vertically connect the printed-wiring board, connect the plug straight terminal connector to the mother board (main board) side and connect the socket right-angle terminal connector to the daughter board (sub board) side.

#### Stacking

Connects the printed-wiring boards parallel to each other. The distance between the boards here is called "stacking height".

#### Horizontal

Connect the printed-wiring boards horizontally.

#### Leaf contact construction

In this structure, contacts are protected by the housing.

#### Mating figure of the XH3A/XH3B

The contacts are protected by the housing when mated so that they do not readily deform.

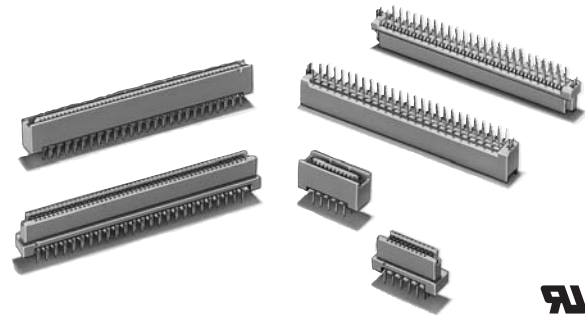
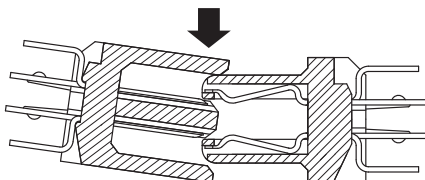

### Ratings and Characteristics

Rated current	0.5 A
Rated voltage	125 VAC
Contact resistance (See note.)	30 mΩ max. (20 mV max., 100 mA max.)
Insulation resistance	1,000 MΩ min. (at 500 VDC)
Dielectric strength	650 VAC for 1 min (leakage current: 1 mA max.)
Total insertion force	0.78 N max. per contact
Total removal force	0.10 N min. per contact
Insertion durability	400 times
Ambient operating temperature	-55 to 105°C (with no condensation or icing)

**Note:** The contact resistance is for the XH3A-□□41 combined with the XH3B-□□41.

### Materials and Finish

Item	Type	Plug	Socket
Housing		PBT (UL94 V-0)/gray	
Locator		PBT (UL94 V-0)/gray	
Contacts	Mating end	Phosphor bronze/nickel base, gold/palladium plating	Phosphor bronze/nickel base, gold/palladium plating
	Terminal	Phosphor bronze/nickel base, tin plating	Phosphor bronze/nickel base, tin plating
Fastening pins		Copper alloy/tin plating	

# XH3A Plug, Straight DIP Terminals

## ■ Dimensions

(unit: mm)

XH3A-□□41  
(Straight DIP Terminals)

XH3A-□□41-A  
(Straight DIP Terminals  
with Fastening Pins)

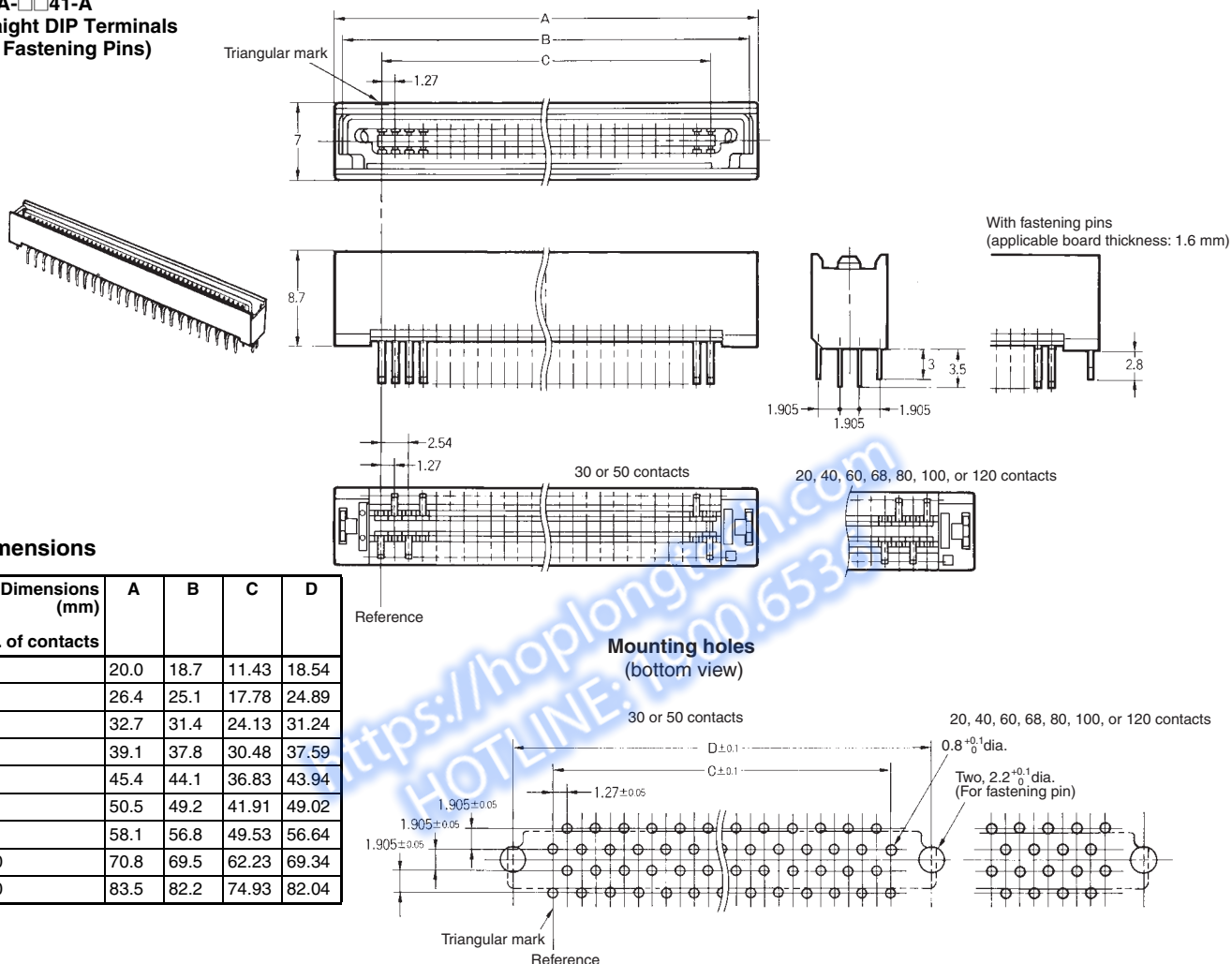

## ■ Ordering Information

Model	Plug/Straight DIP Terminals	Plug/Straight DIP Terminals with fastening pins (See note.)
No. of contacts		
20	XH3A-2041	XH3A-2041-A
30	XH3A-3041	XH3A-3041-A
40	XH3A-4041	XH3A-4041-A
50	XH3A-5041	XH3A-5041-A
60	XH3A-6041	XH3A-6041-A
68	XH3A-6841	XH3A-6841-A
80	XH3A-8041	XH3A-8041-A
100	XH3A-0141	XH3A-0141-A
120	XH3A-0241	XH3A-0241-A

Note: Applicable board thickness is 1.6 mm.

# XH3A Plug, Straight DIP Terminals

## Stacking Space Adjustable in Increments of 2 or 4 mm

### ■ Dimensions

(unit: mm)

XH3A-□□41-2A (2-mm Increments)  
(Straight DIP Terminals with Fastening Pins)

XH3A-□□41-4A (4-mm Increments)  
(Straight DIP Terminals with Fastening Pins)

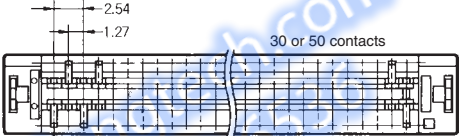
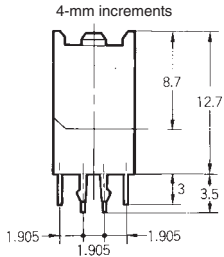
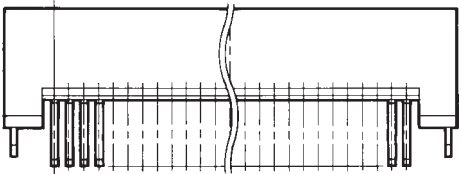
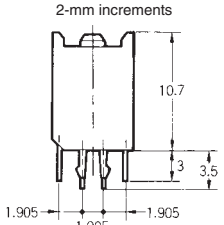
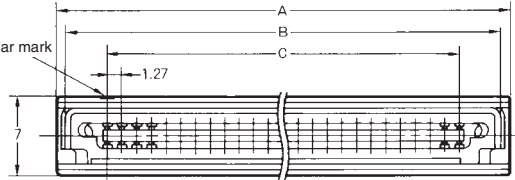
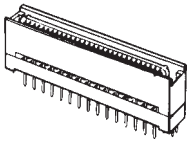

20, 40, 60, 68, 80, 100, or 120 contacts

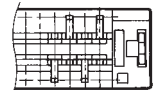

### Dimensions

Dimensions (mm)	A	B	C	D
No. of contacts				
20	20.0	18.7	11.43	18.54
30	26.4	25.1	17.78	24.89
40	32.7	31.4	24.13	31.24
50	39.1	37.8	30.48	37.59
60	45.4	44.1	36.83	43.94
68	50.5	49.2	41.91	49.02
80	58.1	56.8	49.53	56.64
100	70.8	69.5	62.23	69.34
120	83.5	82.2	74.93	82.04

Mounting holes (bottom view)

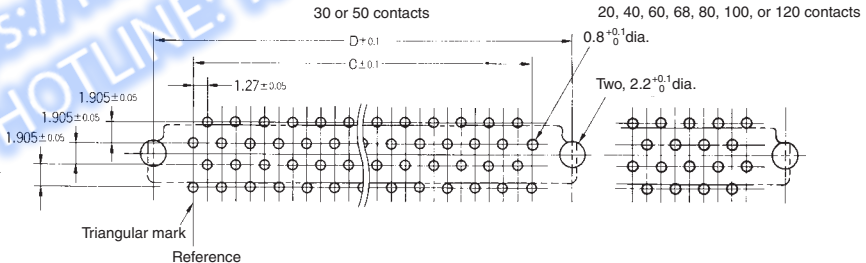

### ■ Ordering Information

Model	Plug/Straight DIP Terminals with fastening pins (2-mm Increments) (See note.)	Plug/Straight DIP Terminals with fastening pins (4-mm Increments) (See note.)
No. of contacts		
20	XH3A-2041-2A	XH3A-2041-4A
30	XH3A-3041-2A	XH3A-3041-4A
40	XH3A-4041-2A	XH3A-4041-4A
50	XH3A-5041-2A	XH3A-5041-4A
60	XH3A-6041-2A	XH3A-6041-4A
68	XH3A-6841-2A	XH3A-6841-4A
80	XH3A-8041-2A	XH3A-8041-4A
100	XH3A-0141-2A	XH3A-0141-4A
120	XH3A-0241-2A	XH3A-0241-4A

Note: Applicable board thickness is 1.6 mm.

# XH3A Plug, Right-angle DIP Terminals

## ■ Dimensions

(unit: mm)

**XH3-□□42-A**  
(Right-angle DIP Terminals with Fastening Pins)

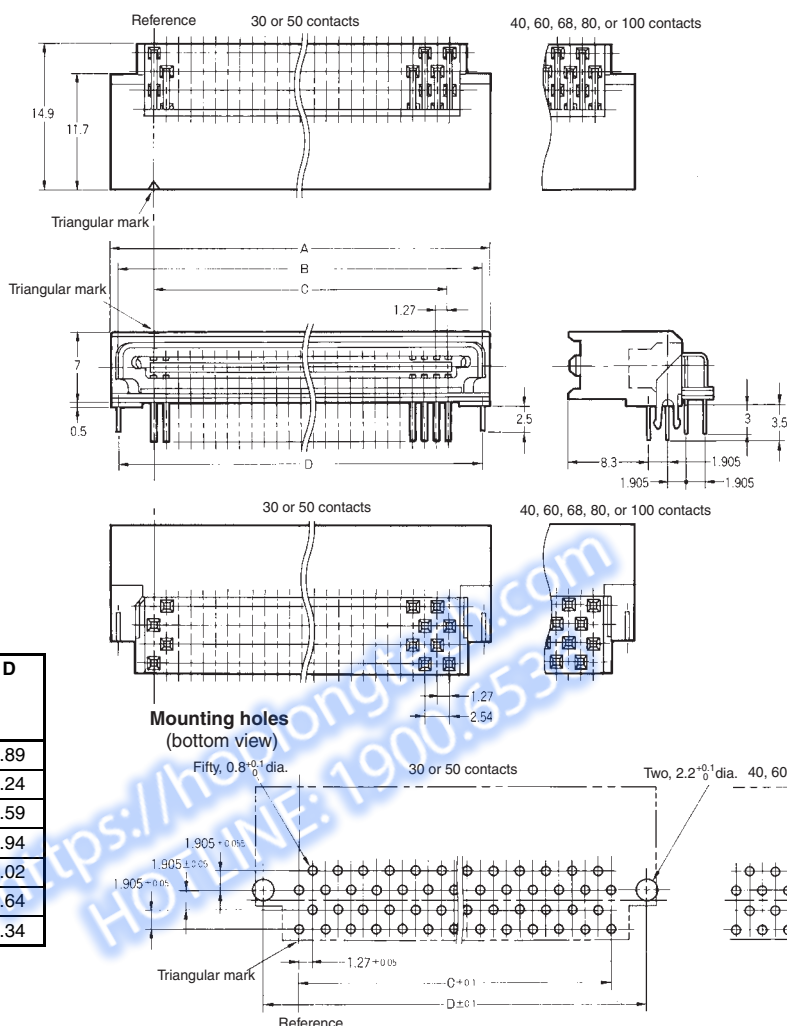
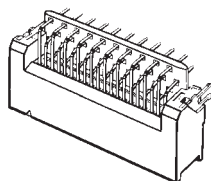

### Dimensions

Dimensions (mm)	A	B	C	D
No. of contacts				
30	26.4	25.1	17.78	24.89
40	32.7	31.4	24.13	31.24
50	39.1	37.8	30.48	37.59
60	45.4	44.1	36.83	43.94
68	50.5	49.2	41.91	49.02
80	58.1	56.8	49.53	56.64
100	70.8	69.5	62.23	69.34

## ■ Ordering Information

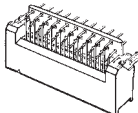
Model	Plug/Right-angle DIP Terminals with fastening pins (See note.)
	
No. of contacts	
30	XH3A-3042-A
40	XH3A-4042-A
50	XH3A-5042-A
60	XH3A-6042-A
68	XH3A-6842-A
80	XH3A-8042-A
100	XH3A-0142-A

**Note:** Applicable board thickness is 1.6 mm.

# XH3B Socket, Straight DIP Terminals

## ■ Dimensions

(unit: mm)

XH3B-□□41

(Straight DIP Terminals)

XH3B-□□41-A

(Straight DIP Terminals with Fastening Pins)

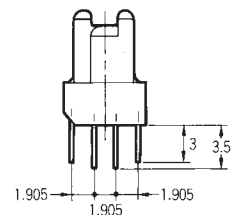
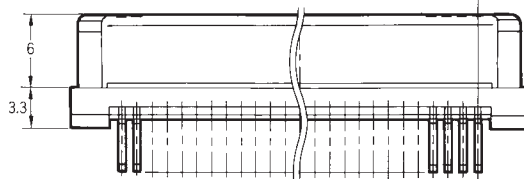
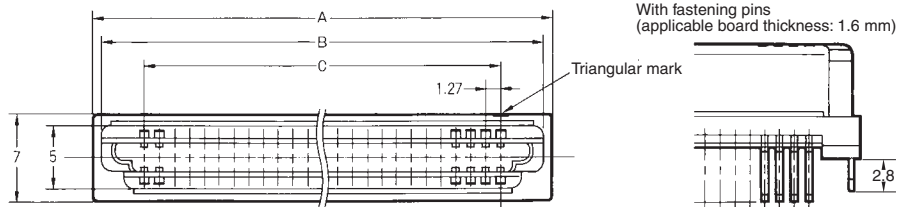
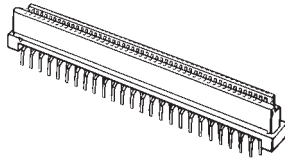

20, 40, 60, 68, 80, 100, or 120 contacts

30 or 50 contacts

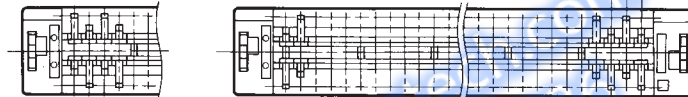

### Dimensions

Dimensions (mm)	A	B	C	D
No. of contacts				
20	20.0	18.6	11.43	18.54
30	26.4	25.0	17.78	24.89
40	32.7	31.3	24.13	31.24
50	39.1	37.7	30.48	37.59
60	45.4	44.0	36.83	43.94
68	50.5	49.1	41.91	49.02
80	58.1	56.7	49.53	56.64
100	70.8	69.4	62.23	69.34
120	83.5	82.1	74.93	82.04

Reference

### Mounting holes (bottom view)

20, 40, 60, 68, 80, 100, or 120 contacts

30 or 50 contacts

Two, 2.2<sup>+0.1</sup> dia.  
(For fastening pin)

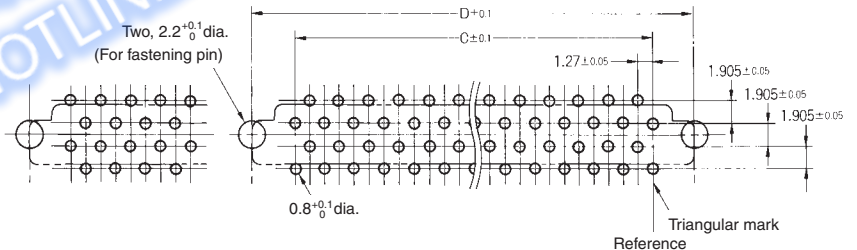

## ■ Ordering Information

Model	Socket/Straight DIP Terminals	Socket/Straight DIP Terminals with fastening pins (See note.)
No. of contacts		
20	XH3B-2041	XH3B-2041-A
30	XH3B-3041	XH3B-3041-A
40	XH3B-4041	XH3B-4041-A
50	XH3B-5041	XH3B-5041-A
60	XH3B-6041	XH3B-6041-A
68	XH3B-6841	XH3B-6841-A
80	XH3B-8041	XH3B-8041-A
100	XH3B-0141	XH3B-0141-A
120	XH3B-0241	XH3B-0241-A

Note: Applicable board thickness is 1.6 mm.

# XH3B Socket, Straight DIP Terminals

## Stacking Space Adjustable in Increments of 1, 3, and 4 mm

### ■ Dimensions

(unit: mm)

- XH3B-□□41-1A (1-mm Increment)  
(Straight DIP Terminals with Fastening Pins)
- XH3B-□□41-3A (3-mm Increments)  
(Straight DIP Terminals with Fastening Pins)
- XH3B-□□41-4A (4-mm Increments)  
(Straight DIP Terminals with Fastening Pins)

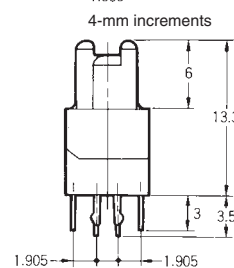
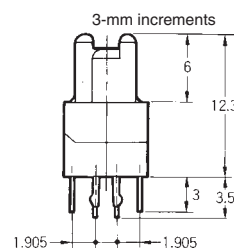
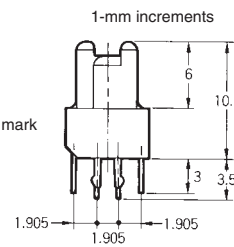
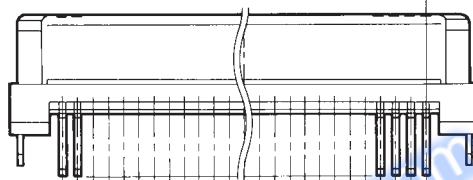
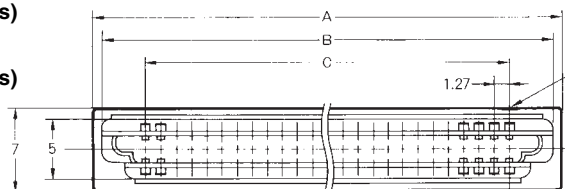
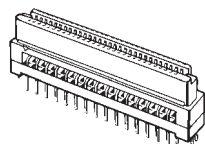

20, 40, 60, 68, 80, 100, or 120 contacts

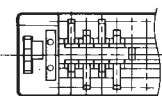

30 or 50 contacts

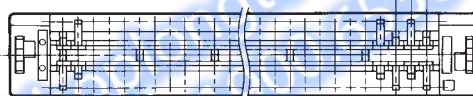

### Dimensions

Dimensions (mm)	A	B	C	D
No. of contacts				
20	20.0	18.6	11.43	18.54
30	26.4	25.0	17.78	24.89
40	32.7	31.3	24.13	31.24
50	39.1	37.7	30.48	37.59
60	45.4	44.0	36.83	43.94
68	50.5	49.1	41.91	49.02
80	58.1	56.7	49.53	56.64
100	70.8	69.4	62.23	69.34
120	83.5	82.1	74.93	82.04

### Mounting holes (bottom view)

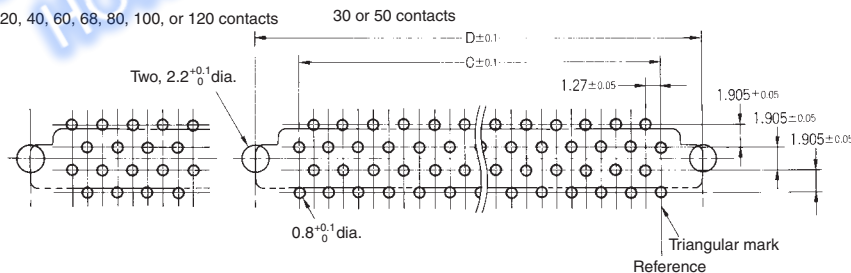

### ■ Ordering Information

No. of contacts	Model	Socket/Straight DIP Terminals with fastening pins (1-mm increment) (See note.)	Socket/Straight DIP Terminals with fastening pins (3-mm increments) (See note.)	Socket/Straight DIP Terminals with fastening pins (4-mm increments) (See note.)
20		XH3B-2041-1A	XH3B-2041-3A	XH3B-2041-4A
30		XH3B-3041-1A	XH3B-3041-3A	XH3B-3041-4A
40		XH3B-4041-1A	XH3B-4041-3A	XH3B-4041-4A
50		XH3B-5041-1A	XH3B-5041-3A	XH3B-5041-4A
60		XH3B-6041-1A	XH3B-6041-3A	XH3B-6041-4A
68		XH3B-6841-1A	XH3B-6841-3A	XH3B-6841-4A
80		XH3B-8041-1A	XH3B-8041-3A	XH3B-8041-4A
100		XH3B-0141-1A	XH3B-0141-3A	XH3B-0141-4A
120		XH3B-0241-1A	XH3B-0241-3A	XH3B-0241-4A

Note: Applicable board thickness is 1.6 mm.

# XH3B Socket, Right-angle DIP Terminals

## ■ Dimensions

(unit: mm)

**XH3B-□□42-A**  
(Right-angle DIP Terminals with Fastening Pins)

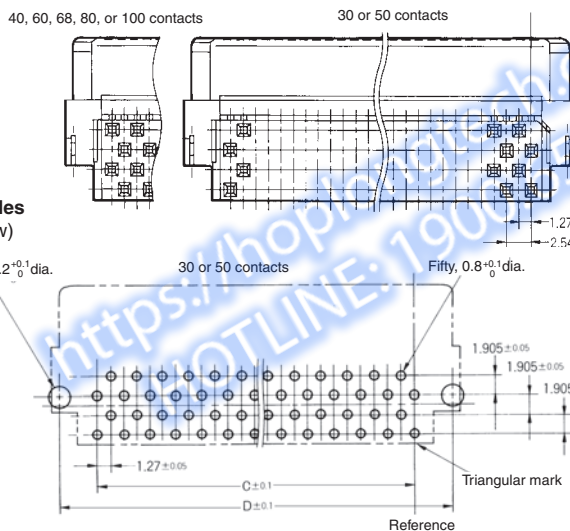
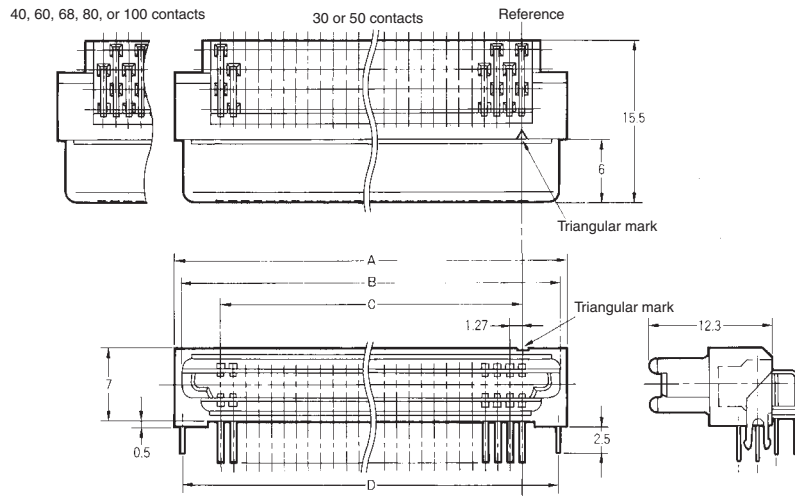
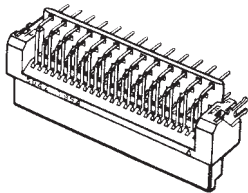

### Dimensions

Dimensions (mm)	A	B	C	D
<b>No. of contacts</b>				
30	26.4	25.0	17.78	24.89
40	32.7	31.3	24.13	31.24
50	39.1	37.7	30.48	37.59
60	45.4	44.0	36.83	43.94
68	50.5	49.1	41.91	49.02
80	58.1	56.7	49.53	56.64
100	70.8	69.4	62.23	69.34

## ■ Ordering Information

Model	Plug/Right-angle DIP Terminals with fastening pins (See note.)
No. of contacts	
30	XH3B-3042-A
40	XH3B-4042-A
50	XH3B-5042-A
60	XH3B-6042-A
68	XH3B-6842-A
80	XH3B-8042-A
100	XH3B-0142-A

**Note:** Applicable board thickness is 1.6 mm.

## Mating Diagram

(unit: mm)

### Vertical/Horizontal/Stacking

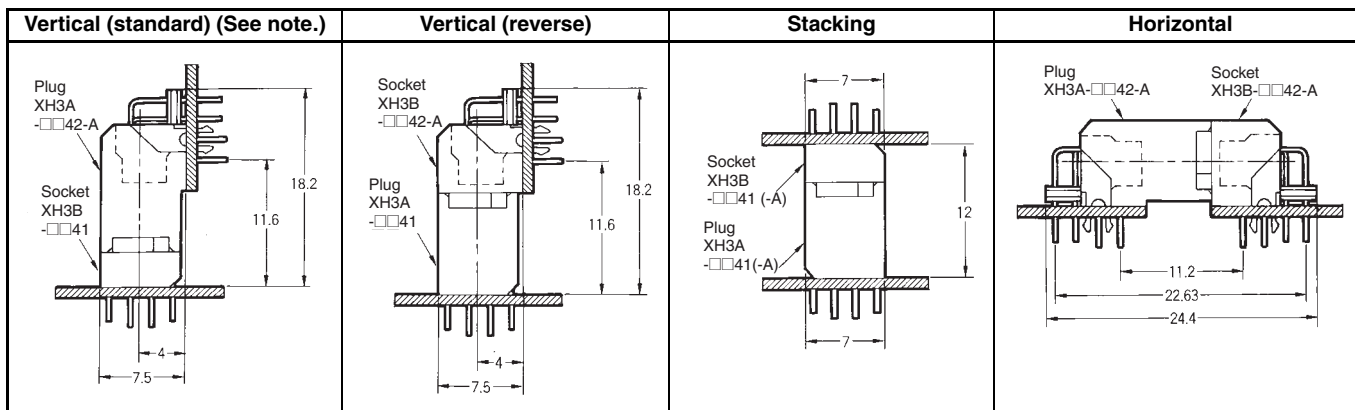

Note: The function of the standard and reverse models is the same as that of the standard XC5 DIN Connectors.

### Stacking Space Adjustable Models

Stacking space	12 mm	13 mm	14 mm	15 mm	16 mm
Mating diagram					
Stacking space	17 mm	18 mm	19 mm	20 mm	
Mating diagram					

### Combinations

Socket	XH3B-□□41 XH3B-□□41-A	1-mm increment XH3B-□□41-1A	3-mm increments XH3B-□□41-3A	4-mm increments XH3B-□□41-4A
Plug				
XH3A-□□41, XH3A-□□41-A	12 mm	13 mm	(15 mm) (See note.)	(16 mm) (See note.)
2-mm increment XH3A-□□41-2A	14 mm	15 mm	(17 mm) (See note.)	18 mm
4-mm increment XH3A-□□41-4A	16 mm	17 mm	19 mm	20 mm

Note: Combinations marked with parentheses must be avoided if possible.



## ■ Contact Numbers

Item	Mated diagram	Mounting holes (bottom view)
Model <b>Plug, Straight Terminals</b>	<p>Triangular mark a1, a2, a3 b1, b2, b3 Reference</p>	<p>Triangular mark Reference</p>
<b>Socket, Straight Terminals</b>	<p>Triangular mark a3, a2, a1 b3, b2, b1 Reference</p>	<p>Reference Triangular mark</p>

• Contact numbers are not printed on the connectors. Use the triangular mark (▼) as a guide when designing and mounting to boards.

• On the mating side, the row of terminals on the triangular mark side are called row a, and the row on the other side is called row b. The numbers are in the order shown.

• The triangular marks on the plug and socket must be aligned when mated. The contact numbers on both sides must match.

## ■ Precautions

### Correct Use

### Mating Compatibility

XH3 Half-pitch Connectors do not mate with XH2 or XH4 Half-pitch Connectors.

### Flux Rise

These Connectors were designed for automatic soldering. If you use a foaming device or brush on flux from the front side, the amount of applied flux will increase and may cause flux rise. Do not use these methods to apply flux.

### Soldering

Automated soldering

Use tape to mask the Right-angle Terminal Connector prior to automated soldering.

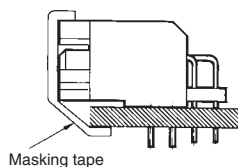

### Automated Soldering Conditions (Jet Flow)

1. Soldering temperature:  $250 \pm 5^\circ\text{C}$
2. Continuous soldering time: Within  $5 \pm 1$  s (Be sure to wash the board after continuous soldering is completed.)

<https://hoplongtech.com>  
HOTLINE: 1900.6536

- Application examples provided in this document are for reference only. In actual applications, confirm equipment functions and safety before using the product.
- Consult your OMRON representative before using the product under conditions which are not described in the manual or applying the product to nuclear control systems, railroad systems, aviation systems, vehicles, combustion systems, medical equipment, amusement machines, safety equipment, and other systems or equipment that may have a serious influence on lives and property if used improperly. Make sure that the ratings and performance characteristics of the product provide a margin of safety for the system or equipment, and be sure to provide the system or equipment with double safety mechanisms.

**Note: Do not use this document to operate the Unit.**

### An Integrated Male/ Female Half-pitch Stacking Connector with Board Space Adjustable from 5 to 11 mm.



- Board space can be adjusted from 5 to 11 mm in 1-mm increments. (Surface-mounted Connectors can be adjusted from 5 to 9 mm in 1-mm increments.)
- The product line includes DIP and SMT Connectors.
- Integrated male/female Connectors.
- All models incorporate fastening pins to secure the terminals, thus preventing floating or falling over during soldering.
- The leaf contact construction resists bending.
- The XH4A conforms to UL standards (file no. E103202). (SMT Connectors not included)
- Not mated with XH2 and XH3 Half-pitch Connectors.

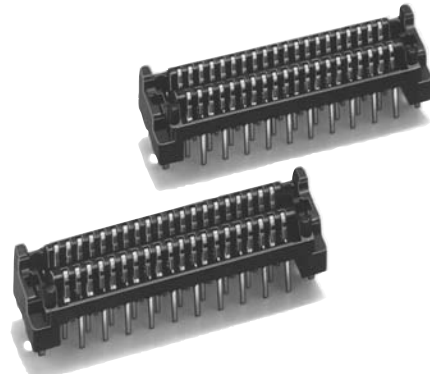

\* Excluding SMT connectors

#### RoHS Compliant

#### ■ Terminology

##### • SMT

The abbreviation of Surface Mount Technology.

##### • Integrated male/female Connectors

The male (plug) and female (socket) have the same shape.

#### ■ Ratings and Characteristics

Rated current	0.5 A
Rated voltage	125 VAC
Contact resistance (See note.)	30 mΩ max. (20 mV max., 100 mA max.)
Insulation resistance	1,000 MΩ min. (at 500 VDC)
Dielectric strength	650 VAC for 1 min (leakage current: 1 mA max.)
Total insertion force	1.47 N max. per contact
Total removal force	0.15 N min. per contact
Insertion durability	50 times
Ambient operating temperature	-55 to 105°C (with no condensation or icing)

**Note:** The contact resistance depends on which XH4A-□□31 Connectors are mated to each other.

#### ■ Materials and Finish

Housing	PPS (UL94 V-0)/black	
Locator	PBT (UL94 V-0)/black	
Contacts	Mating end	Phosphor bronze/nickel base, gold plating
	Terminal	Phosphor bronze/nickel base, gold flash plating
Fastening pins	Copper alloy/tin plating	

# XH4A Straight DIP Terminals

## ■ Dimensions

(unit: mm)

XH4A-□□31  
(Straight DIP Terminals)

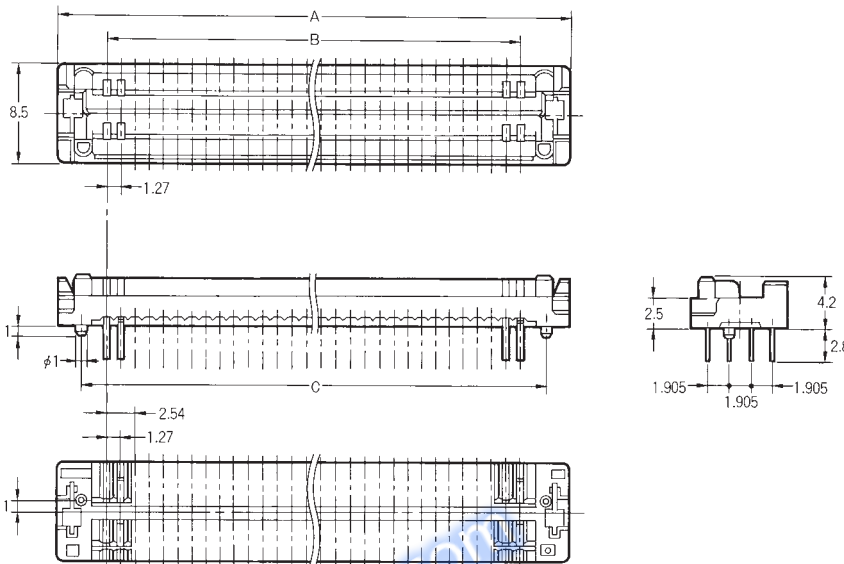
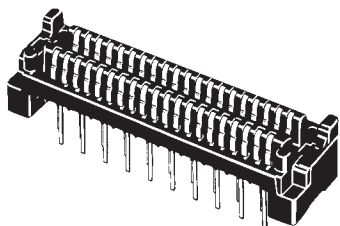

### Dimensions

Dimensions (mm)	A	B	C
No. of contacts			
40	32.73	24.13	28.63
50	39.08	30.48	34.98
60	45.43	36.83	41.33
80	58.13	49.53	54.03
100	70.83	62.23	66.73

Reference  
Mounting holes  
(bottom view)  
40, 60, 80, 100 contacts

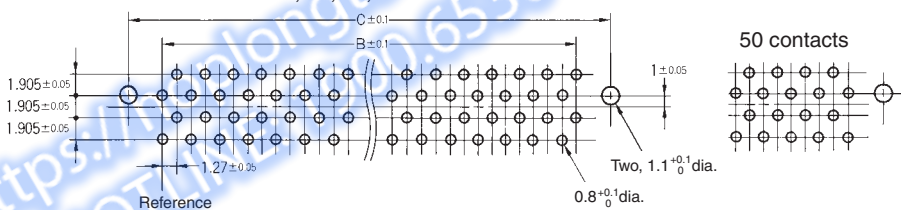

## ■ Ordering Information

Model	Straight DIP Terminals
No. of contacts	
40	XH4A-4031
50	XH4A-5031
60	XH4A-6031
80	XH4A-8031
100	XH4A-0131

# XH4A Straight DIP Terminals

## Stacking Space Adjustable in Standard Size and 1-, 2-, or 3-mm Increments

### ■ Dimensions

(unit: mm)

- XH4A-□□31-A (Standard)
  - XH4A-□□31-1A (1-mm Increment)
  - XH4A-□□31-2A (2-mm Increments)
  - XH4A-□□31-3A (3-mm Increments)
- (Straight DIP Terminals with Fastening Pins)

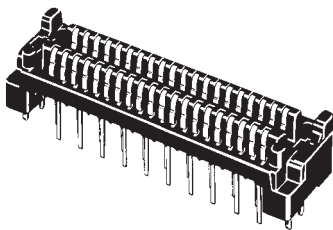

#### Dimensions

Dimensions (mm)	A	B	C
No. of contacts			
40	32.73	24.13	30.23
50	39.08	30.48	36.58
60	45.43	36.83	42.93
80	58.13	49.53	55.63
100	70.83	62.23	68.33

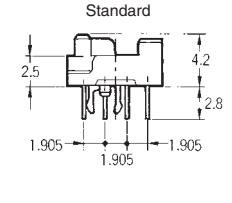
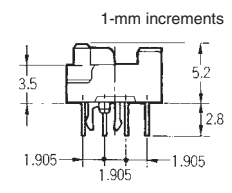
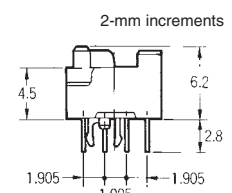
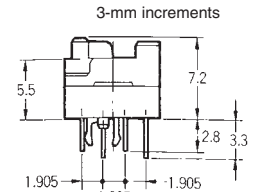
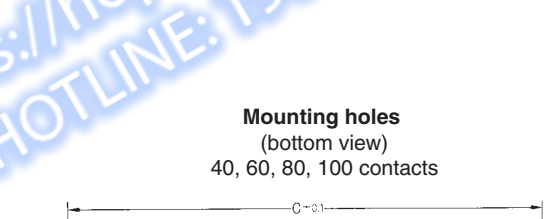
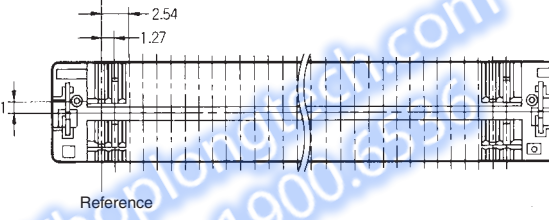
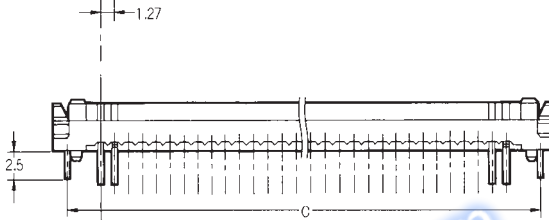
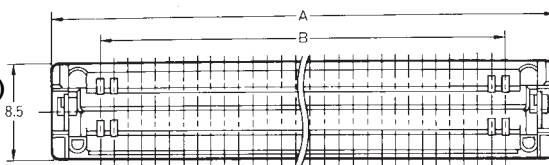

Mounting holes (bottom view)  
40, 60, 80, 100 contacts

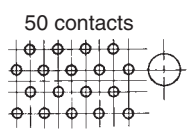
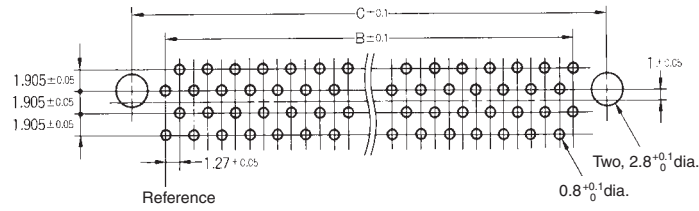

### ■ Ordering Information

Model	Straight DIP Terminals with fastening pins (See note.) (Standard)	Straight DIP Terminals with fastening pins (See note.) (1-mm increment)	Straight DIP Terminals with fastening pins (See note.) (2-mm increments)	Straight DIP Terminals with fastening pins (See note.) (3-mm increments)
40	XH4A-4031-A	XH4A-4031-1A	XH4A-4031-2A	XH4A-4031-3A
50	XH4A-5031-A	XH4A-5031-1A	XH4A-5031-2A	XH4A-5031-3A
60	XH4A-6031-A	XH4A-6031-1A	XH4A-6031-2A	XH4A-6031-3A
80	XH4A-8031-A	XH4A-8031-1A	XH4A-8031-2A	XH4A-8031-3A
100	XH4A-0131-A	XH4A-0131-1A	XH4A-0131-2A	XH4A-0131-3A

Note: Applicable board thickness is 1.6 mm.

# XH4A SMT Terminals

## Stacking Space Adjustable in Standard Size and 1- or 2-mm Increments

### ■ Dimensions

- XH4A-□□35-A (Standard)
- XH4A-□□35-1A (1-mm Increment)
- XH4A-□□35-2A (2-mm Increments)
- (SMT Terminals with Fastening Pins)

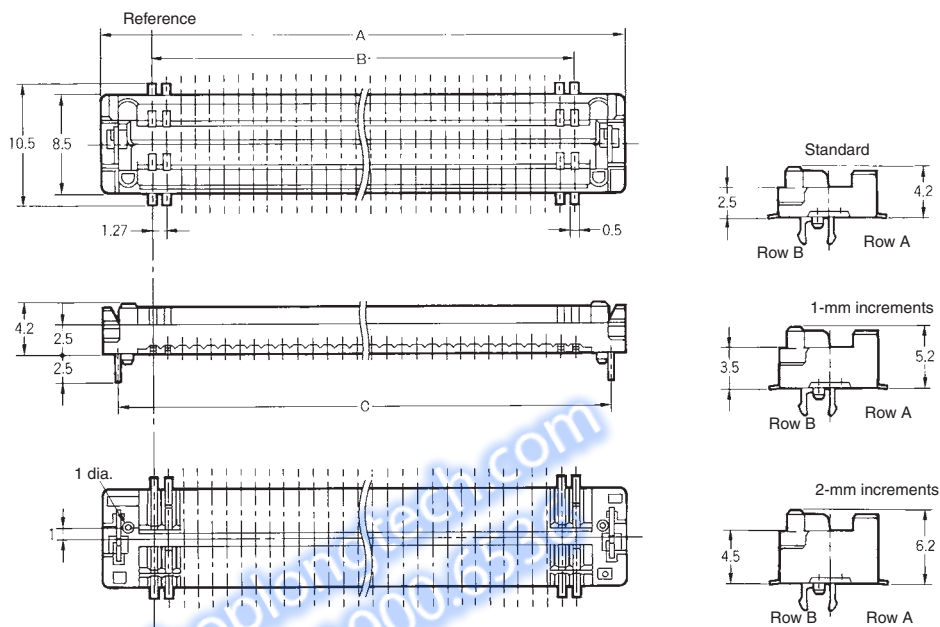
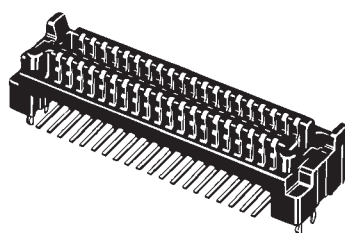

#### Dimensions

Dimensions (mm)	A	B	C
No. of contacts			
40	32.73	24.13	30.23
50	39.08	30.48	36.58
60	45.43	36.83	42.93
80	58.13	49.53	55.63
100	70.83	62.23	68.33

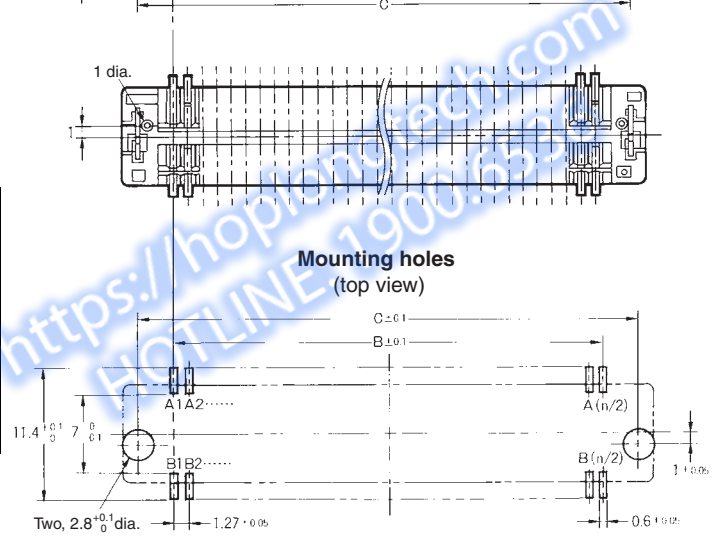

### ■ Ordering Information

Model	SMT Terminals with fastening pins (See note.) (Standard)	SMT Terminals with fastening pins (See note.) (1-mm increment)	SMT Terminals with fastening pins (See note.) (2-mm increments)
No. of contacts			
40	XH4A-4035-A	XH4A-4035-1A	XH4A-4035-2A
50	XH4A-5035-A	XH4A-5035-1A	XH4A-5035-2A
60	XH4A-6035-A	XH4A-6035-1A	XH4A-6035-2A
80	XH4A-8035-A	XH4A-8035-1A	XH4A-8035-2A
100	XH4A-0135-A	XH4A-0135-1A	XH4A-0135-2A

Note: Applicable board thickness is 1.6 mm.

## ■ Mating Diagram (unit: mm)

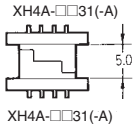
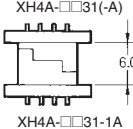
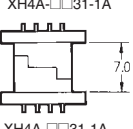
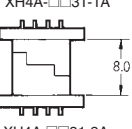
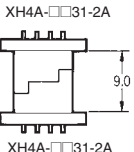
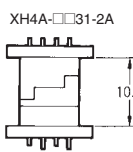
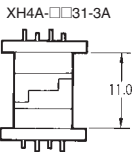

### Stacked DIP Terminals

Stacking space	5 mm	6 mm	7 mm	8 mm
Mating diagram				
Stacking space	9 mm	10 mm	11 mm	
Mating diagram				

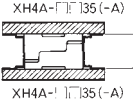
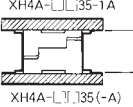
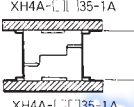
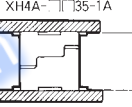
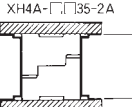
### Stacked SMT Terminals

Stacking space	5 mm	6 mm	7 mm	8 mm	9 mm
Mating diagram					

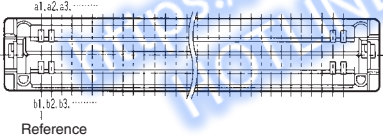
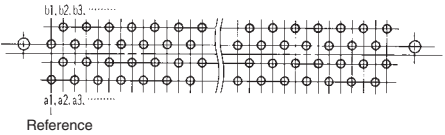
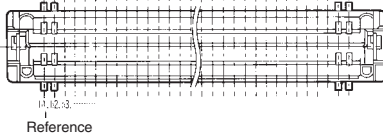
## ■ Contact Numbers

Item	Mated Diagram	Mounting holes
DIP Terminals		(bottom view) 
SMT Terminals		(top view) 

• The triangular mark (▼) and contact numbers are not printed on the connectors. Use the raised reference point used to prevent reverse insertion as a guide when designing boards.

• On the mating side, the row of terminals on the raised reference point side are called row a, and the row on the other side is called row b. The numbers are in the order shown.

• XH4A Half-pitch Connectors are integrated male/female connectors. The contact numbers on row a correspond to the contact numbers on row b. Be careful when using these connectors because they function slightly differently from separate male and female connectors (i.e., Plugs and Sockets).

## ■ Precautions

### Correct Use

#### PCB settings

XH4A Half-pitch Connectors are male/female connectors with integrated plugs and sockets.

Refer to **Contact Numbers** above when designing boards.

### Mating Compatibility

XH4 Half-pitch Connectors do not mate with XH2 or XH3 Half-pitch Connectors.

### Soldering Conditions

Straight DIP Terminals (Automated Soldering)

- (1) Soldering temperature: 250±5°C
- (2) Continuous soldering time: Within 5±1 s

Be sure to wash the board after automated soldering is completed.

#### SMT Terminals

Recommended reflow conditions

- Pre-heat temperature: 150±10°C
- Pre-heat time: 60 to 120 s
- Soldering temperature: 200 to 240°C
- Soldering time: Within 30 s
- (Within 10 s at the maximum temperature of 240°C)

<https://hoplongtech.com>  
HOTLINE: 1900.6536

- Application examples provided in this document are for reference only. In actual applications, confirm equipment functions and safety before using the product.
- Consult your OMRON representative before using the product under conditions which are not described in the manual or applying the product to nuclear control systems, railroad systems, aviation systems, vehicles, combustion systems, medical equipment, amusement machines, safety equipment, and other systems or equipment that may have a serious influence on lives and property if used improperly. Make sure that the ratings and performance characteristics of the product provide a margin of safety for the system or equipment, and be sure to provide the system or equipment with double safety mechanisms.

**Note: Do not use this document to operate the Unit.**